



US00D857128S

(12) **United States Design Patent** (10) **Patent No.:** **US D857,128 S**  
**Wu** (45) **Date of Patent:** **\*\* Aug. 20, 2019**

(54) **MASK**

(71) Applicant: **Chun-Hung Wu**, New Taipei (TW)

(72) Inventor: **Chun-Hung Wu**, New Taipei (TW)

(\*\*) Term: **15 Years**

(21) Appl. No.: **29/664,712**

(22) Filed: **Sep. 27, 2018**

**Related U.S. Application Data**

(62) Division of application No. 29/572,892, filed on Aug. 1, 2016, now Pat. No. Des. 832,941.

(51) **LOC (12) Cl.** ..... **21-03**

(52) **U.S. Cl.**  
USPC ..... **D21/660**

(58) **Field of Classification Search**  
USPC ..... D21/576–579, 585, 588, 593, 594, 612,  
D21/621, 623, 625, 626, 627, 631, 633,  
D21/635, 639, 645, 649, 658, 659–661  
(Continued)

(56) **References Cited**

**U.S. PATENT DOCUMENTS**

452,155 A \* 5/1891 Ahlstrom ..... A41D 13/11  
2/206  
587,687 A \* 8/1897 Harder ..... A41D 13/11  
2/206

(Continued)

**OTHER PUBLICATIONS**

<http://www.theatregarage.ca/event/mask-making-megan-koshka/>—  
Retrieved Jun. 5, 2018.

(Continued)

*Primary Examiner* — Khawaja Anwar  
*Assistant Examiner* — Mojtaba Tehrani

(74) *Attorney, Agent, or Firm* — Muncy, Geissler, Olds & Lowe, P.C.

(57) **CLAIM**

The ornamental design for a mask, as shown and described.

**DESCRIPTION**

FIG. 1 is a perspective view of a first embodiment of a mask showing my new design;  
FIG. 2 is a front elevational view thereof in which the profile lines 8-8 and 9-9 herein form no part of the claimed design;  
FIG. 3 is a rear elevational view thereof;  
FIG. 4 is a left elevational view thereof;  
FIG. 5 is a right elevational view thereof;  
FIG. 6 is a top plan view thereof;  
FIG. 7 is a bottom plan view thereof;  
FIG. 8 is a cross-sectional view along line 8-8 shown in FIG. 2;  
FIG. 9 is a cross-sectional view along line 9-9 shown in FIG. 2;  
FIG. 10 is a perspective view thereof in condition of use, where the design is adapted to fit a lower portion of a human's face;  
FIG. 11 is a perspective view thereof in condition of use, where the design is adapted to fit an upper portion of the human's face;  
FIG. 12 is a perspective view of a second embodiment of a mask showing my new design;  
FIG. 13 is a front elevational view thereof in which the profile lines 19-19 and 20-20 herein form no part of the claimed design;  
FIG. 14 is a rear elevational view thereof;  
FIG. 15 is a left elevational view thereof;  
FIG. 16 is a right elevational view thereof;  
FIG. 17 is a top plan view thereof;  
FIG. 18 is a bottom plan view thereof;  
FIG. 19 is a cross-sectional view along line 19-19 shown in FIG. 13;  
FIG. 20 is a cross-sectional view along line 20-20 shown in FIG. 13;

(Continued)

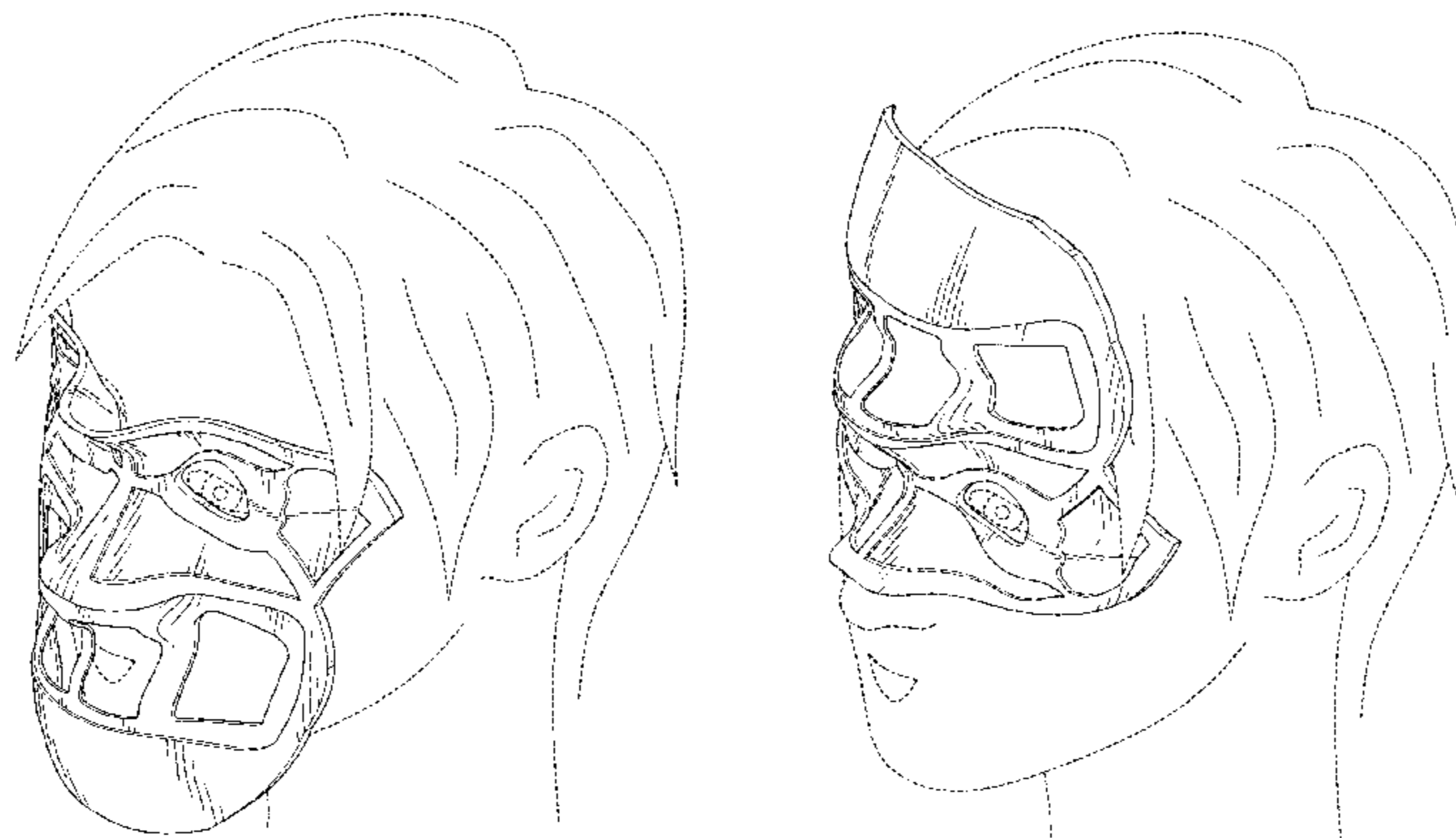

FIG. 21 is a perspective view thereof in condition of use, where the design is adapted to fit a lower portion of a human's face;

FIG. 22 is a perspective view thereof in condition of use, where the design is adapted to fit an upper portion of the human's face;

FIG. 23 is a perspective view of a third embodiment of a mask showing my new design;

FIG. 24 is a front elevational view thereof in which the profile lines 30-30 and 31-31 herein form no part of the claimed design;

FIG. 25 is a rear elevational view thereof;

FIG. 26 is a left elevational view thereof;

FIG. 27 is a right elevational view thereof;

FIG. 28 is a top plan view thereof;

FIG. 29 is a bottom plan view thereof;

FIG. 30 is a cross-sectional view along line 30-30 shown in FIG. 24;

FIG. 31 is a cross-sectional view along line 31-31 shown in FIG. 24;

FIG. 32 is a perspective view thereof in condition of use, where the design is adapted to fit a lower portion of a human's face; and,

FIG. 33 is a perspective view thereof in condition of use, where the design is adapted to fit an upper portion of the human's face.

The design is adapted to be optionally fitted to an upper portion of a human's face or to a lower portion of the human's face.

The dash-dot line broken line in the drawings illustrates section cut lines; the evenly broken lines disclose unclaimed environment. The broken lines form no part of the claimed design.

**1 Claim, 27 Drawing Sheets**

**(58) Field of Classification Search**

CPC ..... A42B 3/20; A42B 3/225; A41D 13/11; A41D 13/1107

See application file for complete search history.

**(56) References Cited**

**U.S. PATENT DOCUMENTS**

885,802 A \* 4/1908 Sterrick ..... A41D 13/11  
2/206  
1,810,486 A \* 6/1931 Lancaster ..... A45D 44/22  
128/206.24

D172,060 S 4/1954 Reich  
D244,880 S \* 6/1977 Terry ..... D16/302  
4,666,148 A \* 5/1987 Crawford ..... A63B 23/03  
482/11  
D307,954 S \* 5/1990 Alber ..... D21/660  
D329,321 S \* 9/1992 Ringwood ..... D2/741  
D335,937 S \* 5/1993 Owens ..... D21/660  
D340,548 S \* 10/1993 Russell ..... D29/108  
D340,549 S \* 10/1993 Russell ..... D29/108  
D355,393 S \* 2/1995 Bezener ..... D11/133  
D423,726 S \* 4/2000 Backus ..... D29/108  
D434,852 S \* 12/2000 Kim ..... D24/200  
D444,920 S 7/2001 Hicks  
D449,902 S 10/2001 Pernicka  
D485,874 S \* 1/2004 Reitz ..... D21/660  
D494,644 S \* 8/2004 Quinn ..... D2/866  
D496,698 S \* 9/2004 Reesman ..... D21/660  
6,938,272 B1 \* 9/2005 Brown ..... A42B 3/20  
2/424  
D632,745 S \* 2/2011 Castaneda ..... D21/660  
D634,373 S \* 3/2011 Marrero ..... D21/659  
D665,536 S 8/2012 Jenke  
D668,022 S 10/2012 Mergler  
D693,056 S \* 11/2013 Omoto ..... D28/7  
D693,057 S \* 11/2013 Omoto ..... D28/7  
D693,058 S \* 11/2013 Omoto ..... D28/7  
D715,453 S \* 10/2014 In ..... D24/206  
D715,454 S \* 10/2014 Riggons ..... D24/206  
D763,515 S \* 8/2016 Chang ..... D29/108  
D768,927 S \* 10/2016 Eisenberg ..... D28/9  
D772,327 S \* 11/2016 Kaufer ..... D16/306  
D787,115 S \* 5/2017 Pan ..... D28/7  
D787,975 S \* 5/2017 Kosann ..... D11/34  
D802,670 S \* 11/2017 Wu ..... D20/23  
D818,200 S \* 5/2018 Broaddus ..... D29/110  
D832,941 S \* 11/2018 Wu ..... D21/660  
D833,674 S \* 11/2018 Pan ..... D28/7  
D836,835 S \* 12/2018 Hazem ..... D28/7  
2004/0139981 A1 \* 7/2004 Liu ..... A45D 40/30  
132/319  
2005/0131504 A1 \* 6/2005 Kim ..... A61F 7/007  
607/104  
2014/0352031 A1 \* 12/2014 Choi ..... A45D 44/002  
2/173

**OTHER PUBLICATIONS**

<https://www.bleedingcool.com/2017/09/23/casey-jones-neca-mask/>—

Published Sep. 23, 2017.

\* cited by examiner

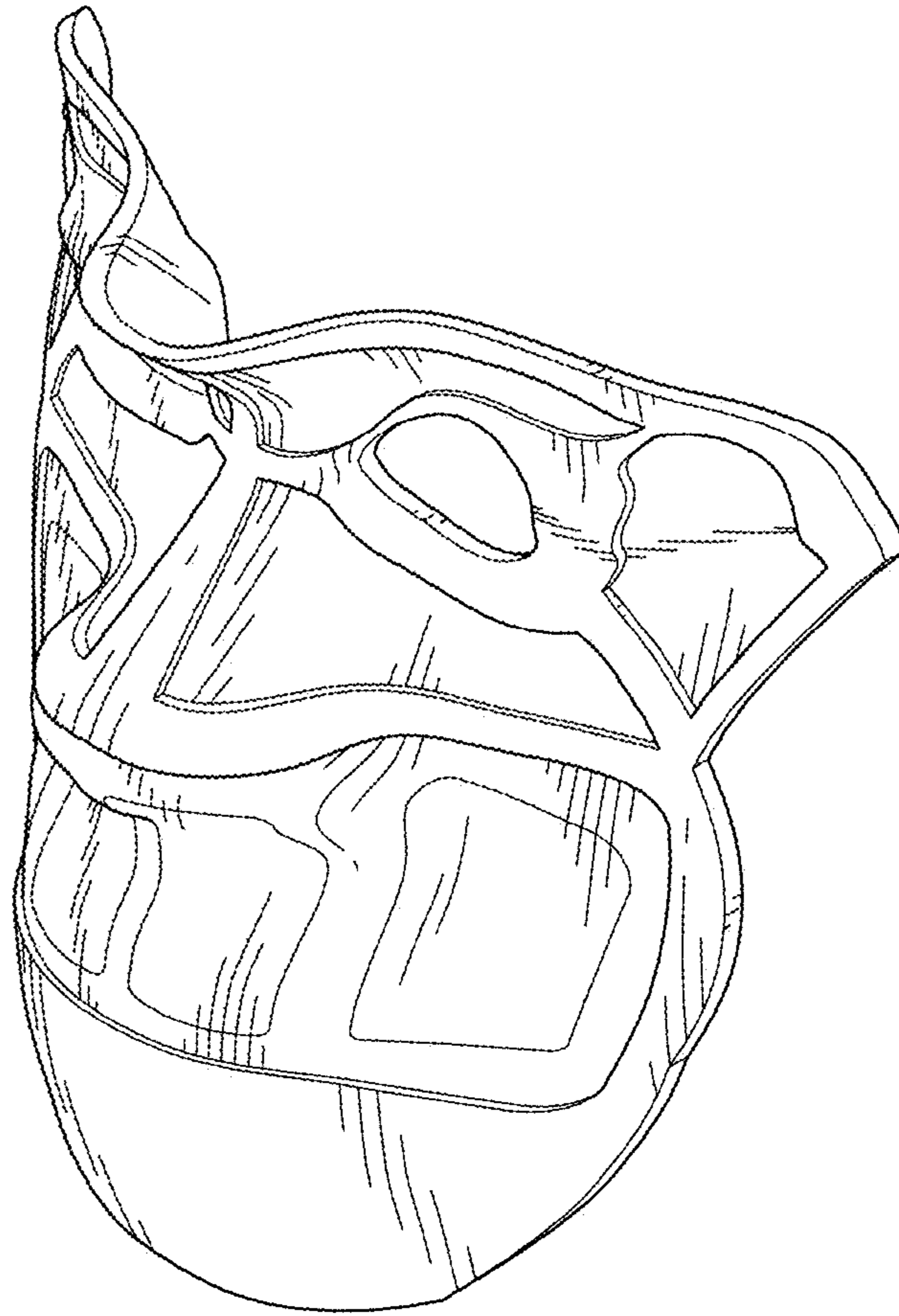

FIG.1

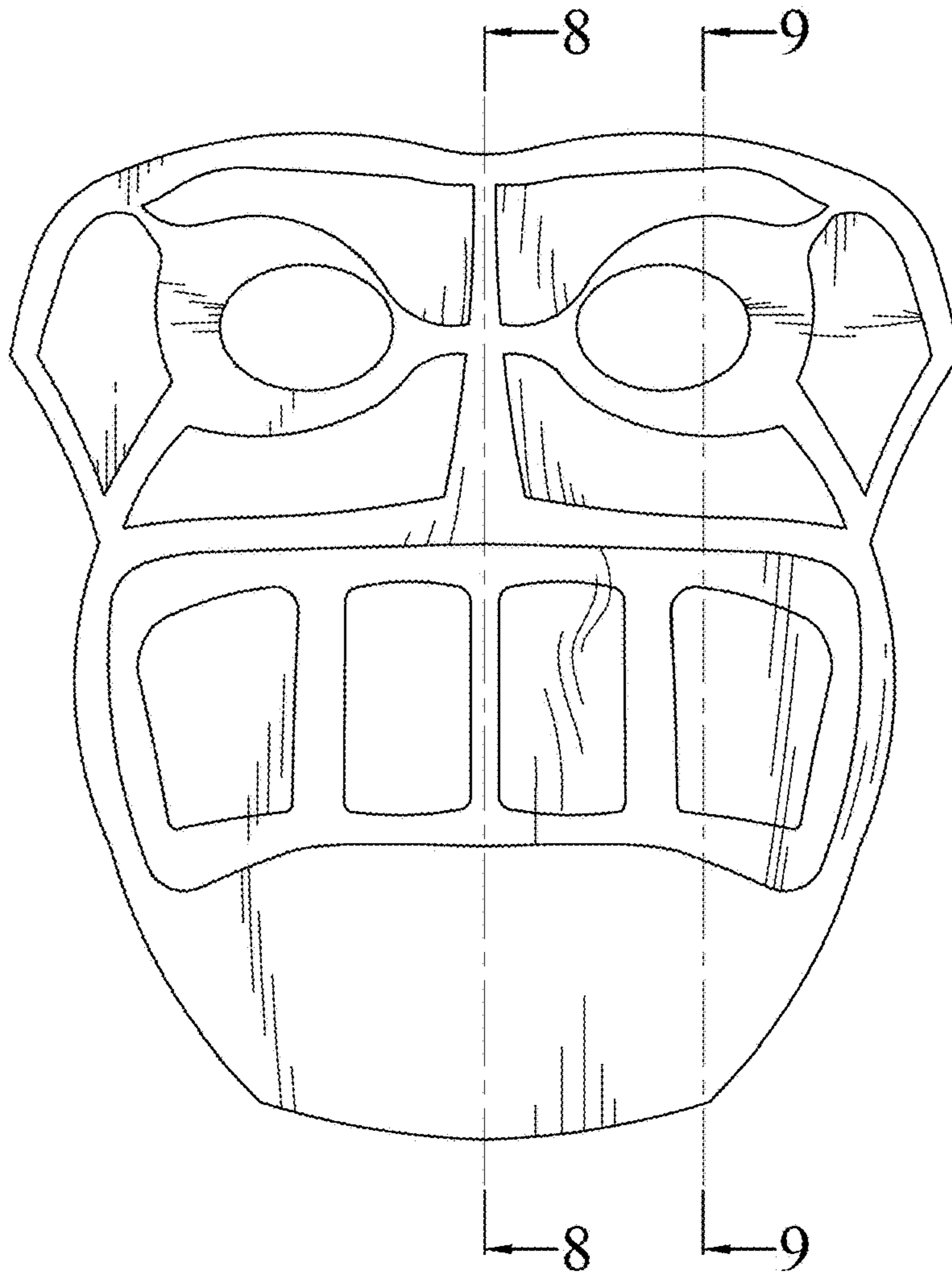

FIG.2

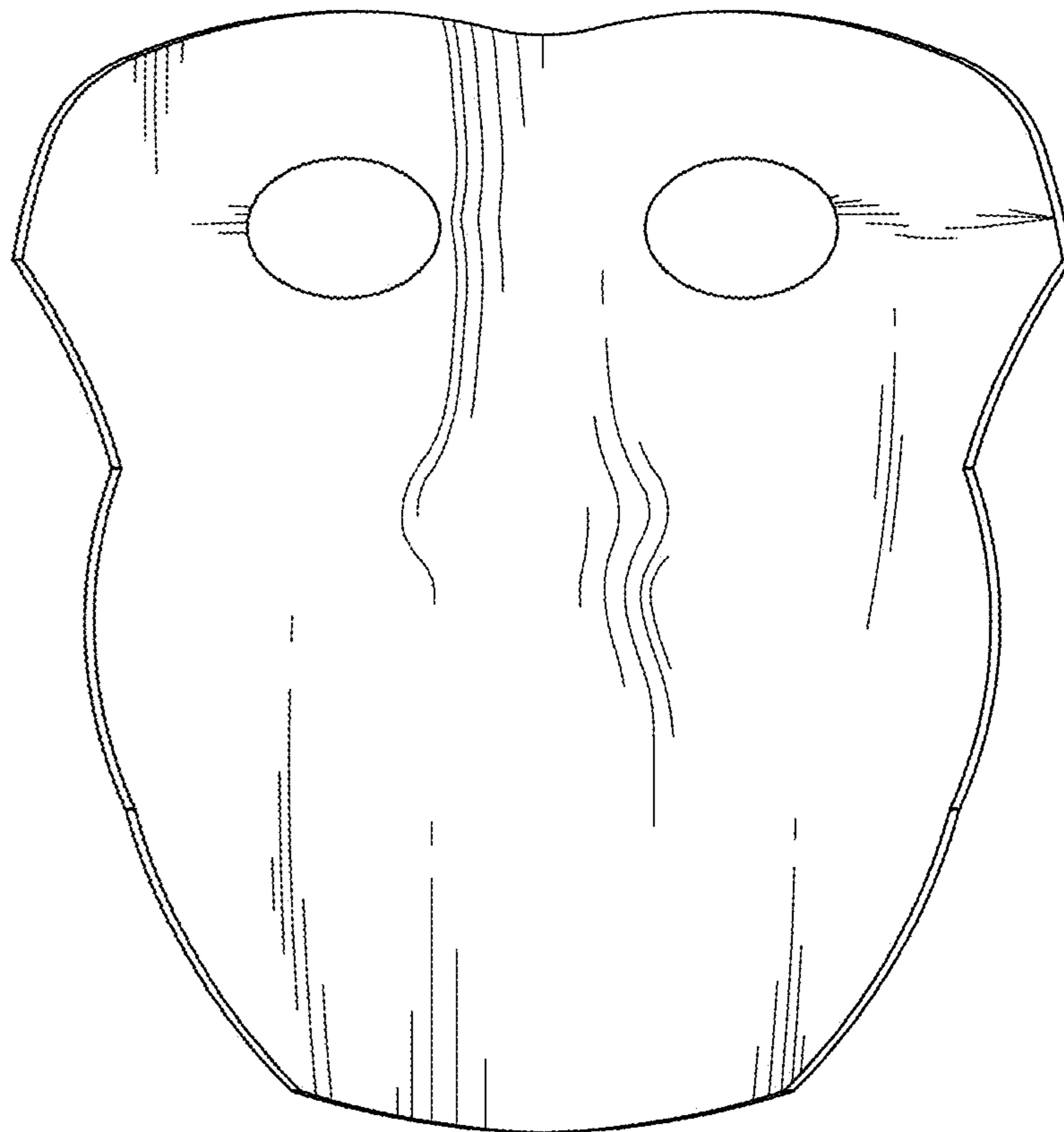

FIG.3

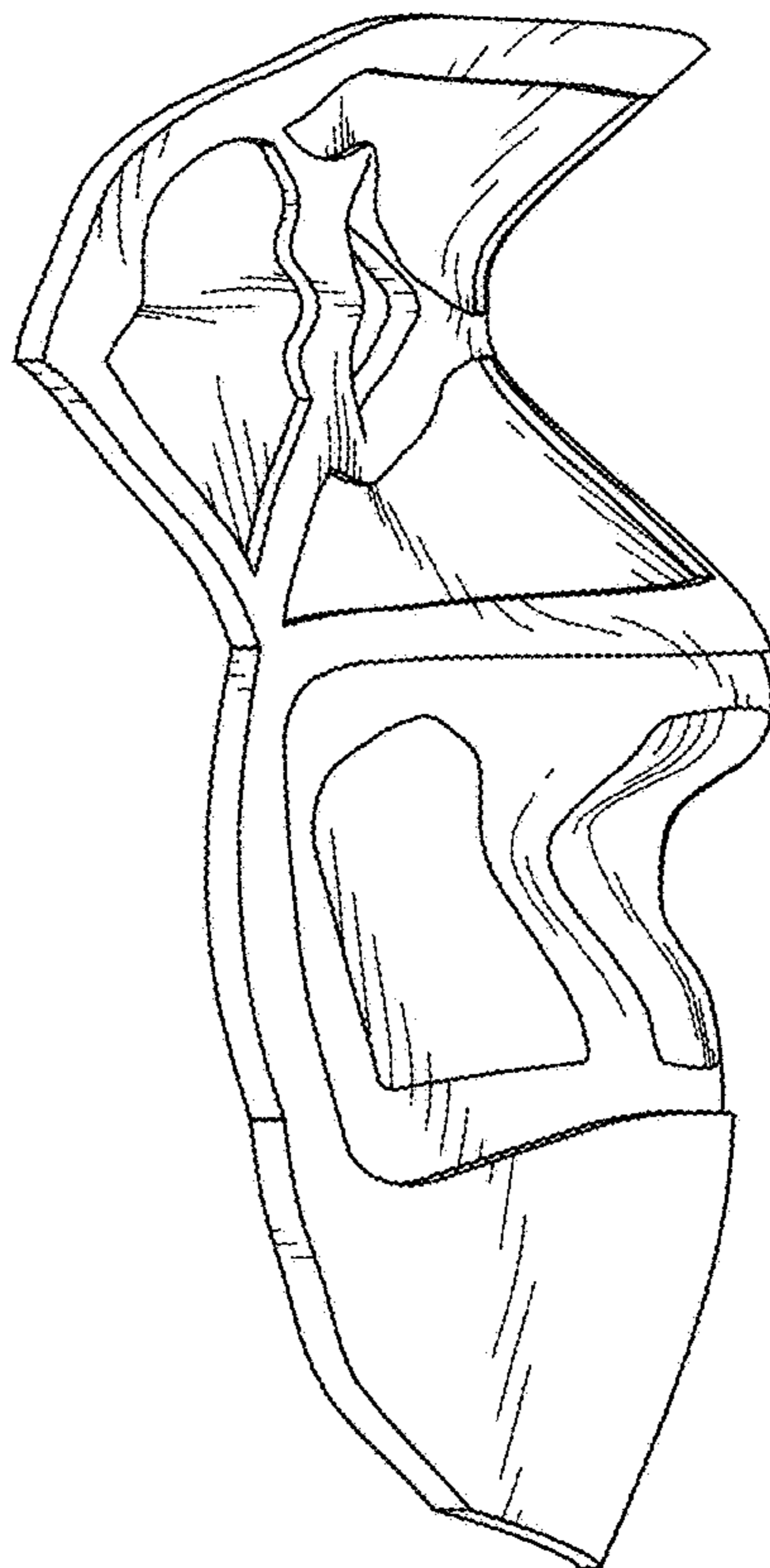

FIG.4

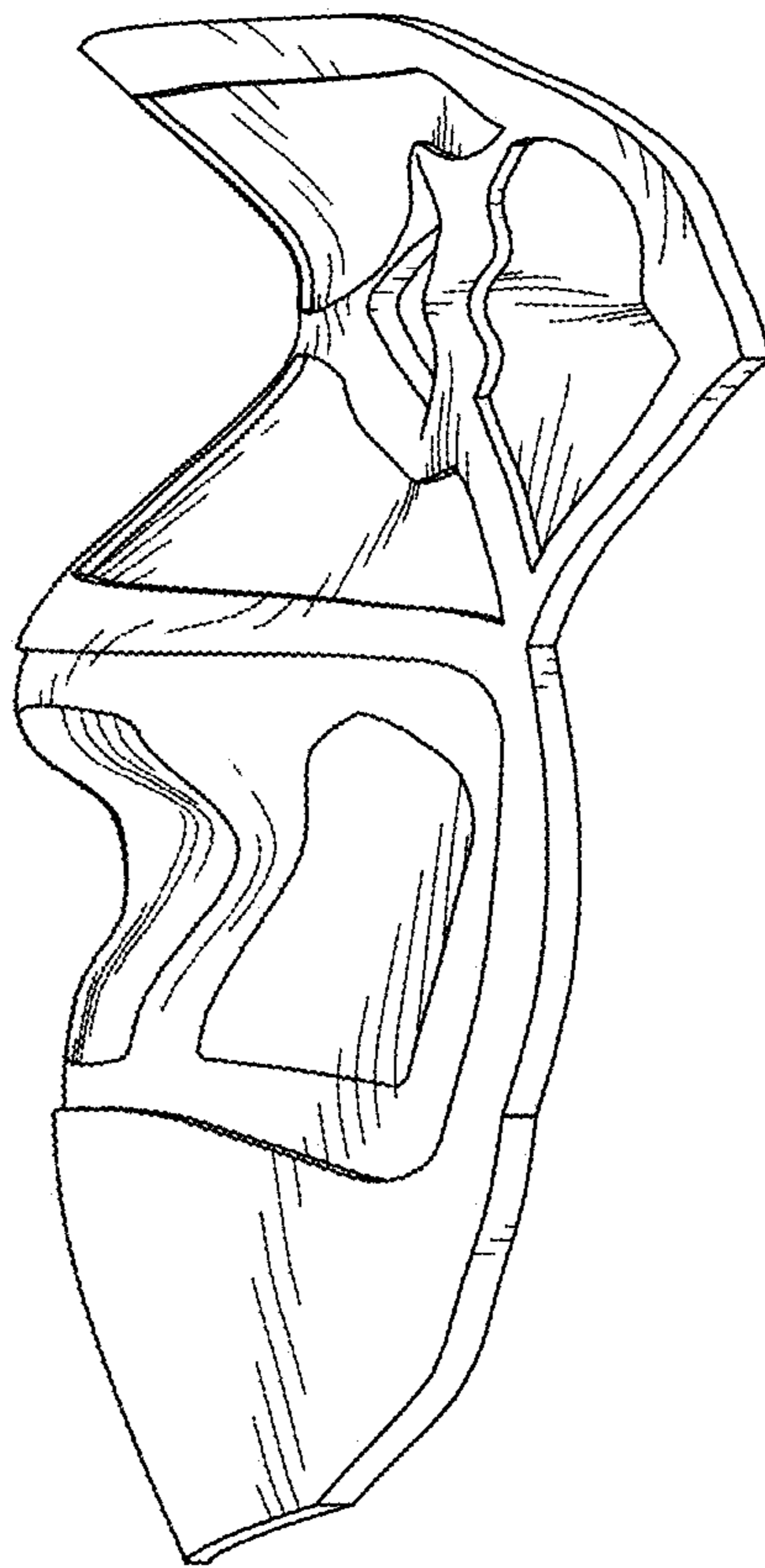

FIG.5

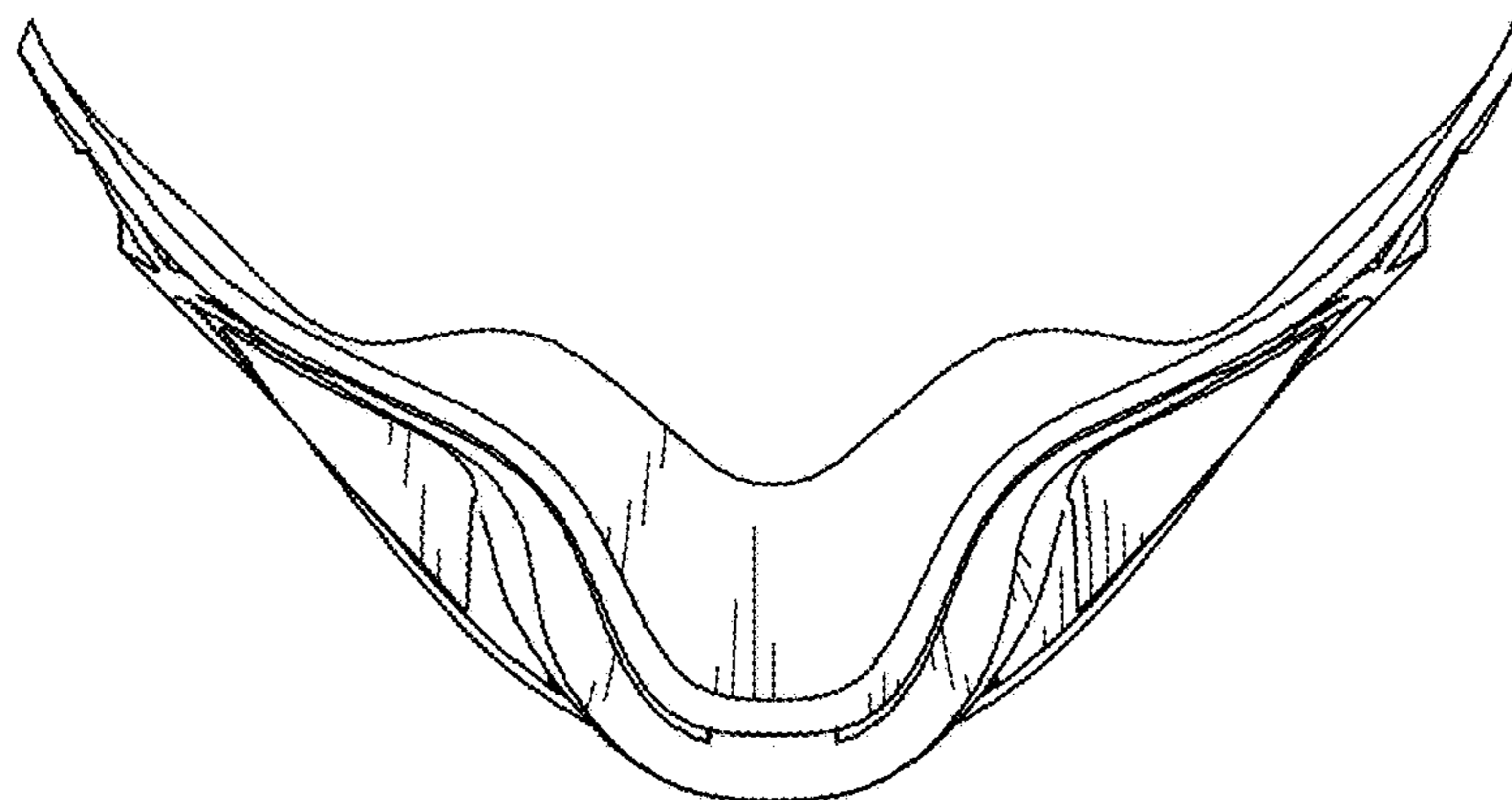

FIG. 6

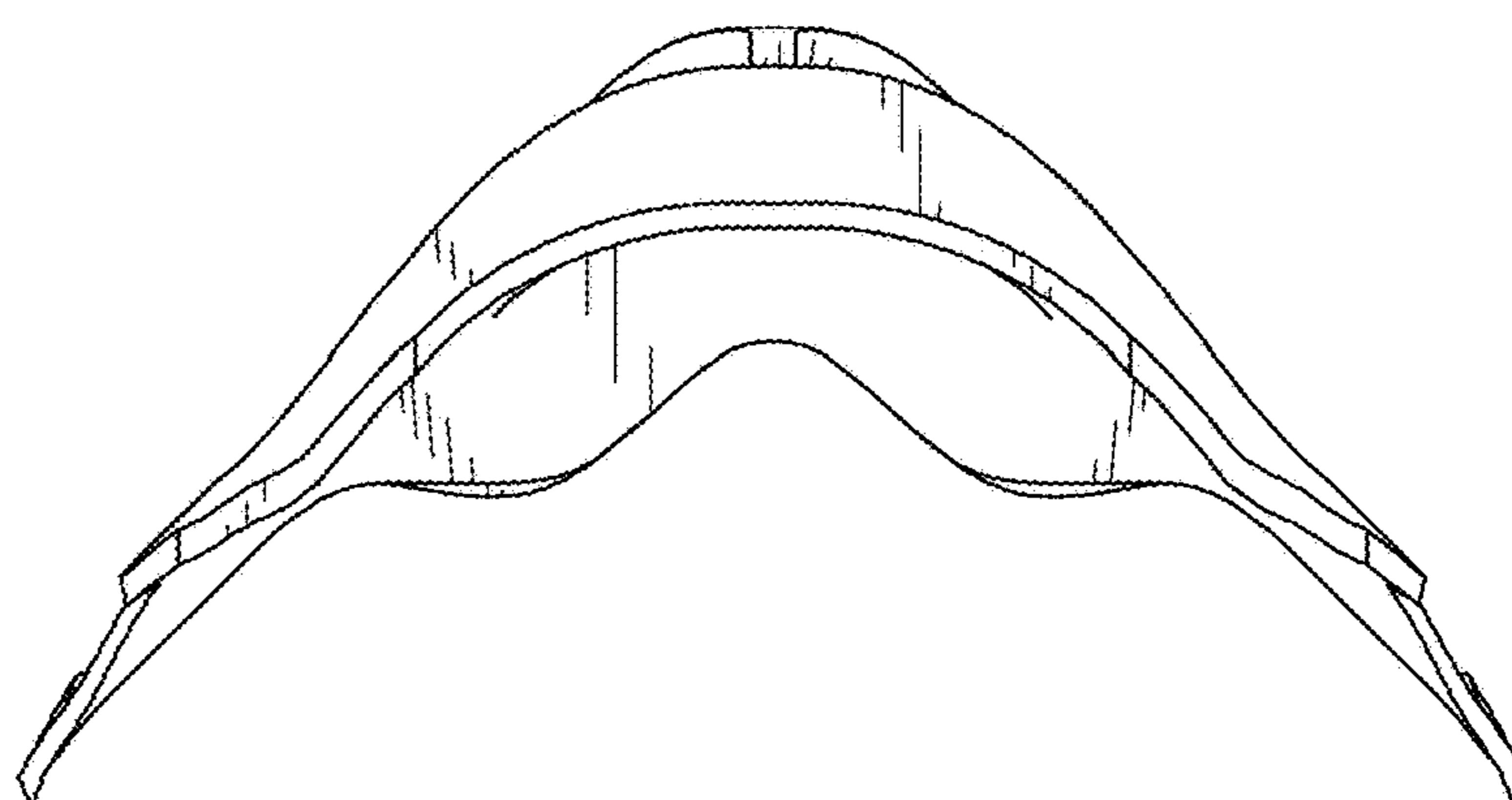

FIG. 7



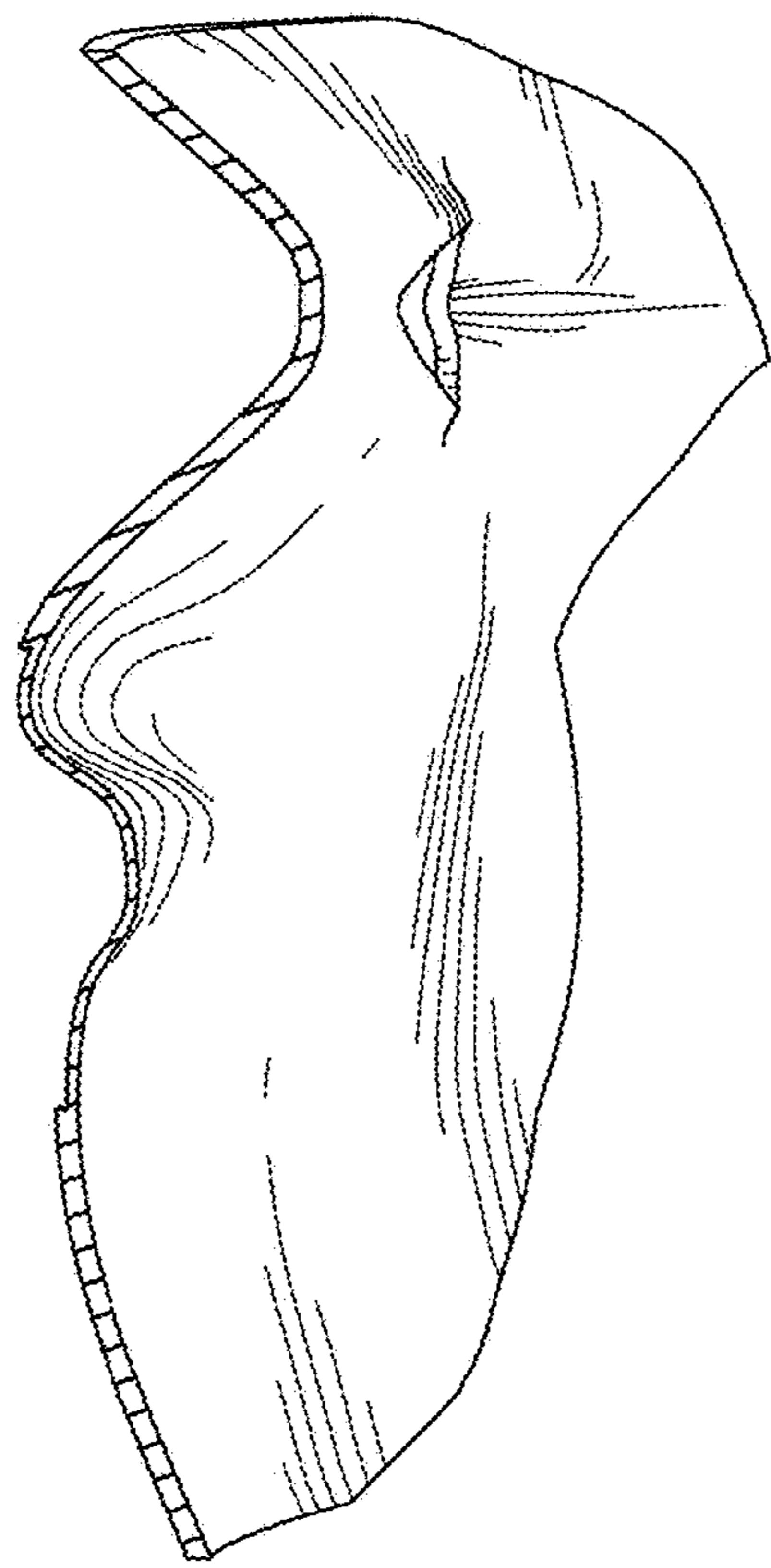

FIG. 8

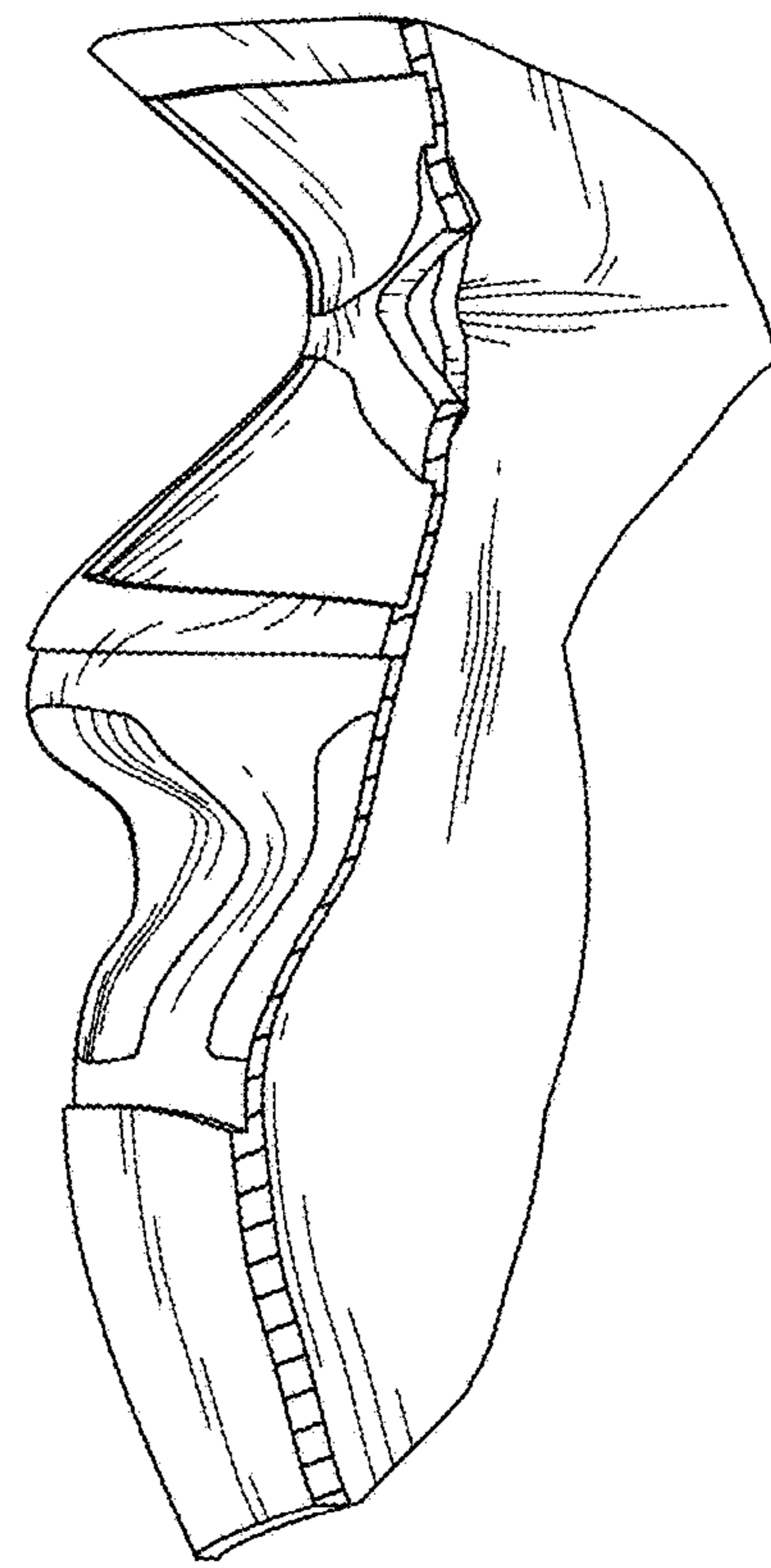

FIG. 9



FIG.10

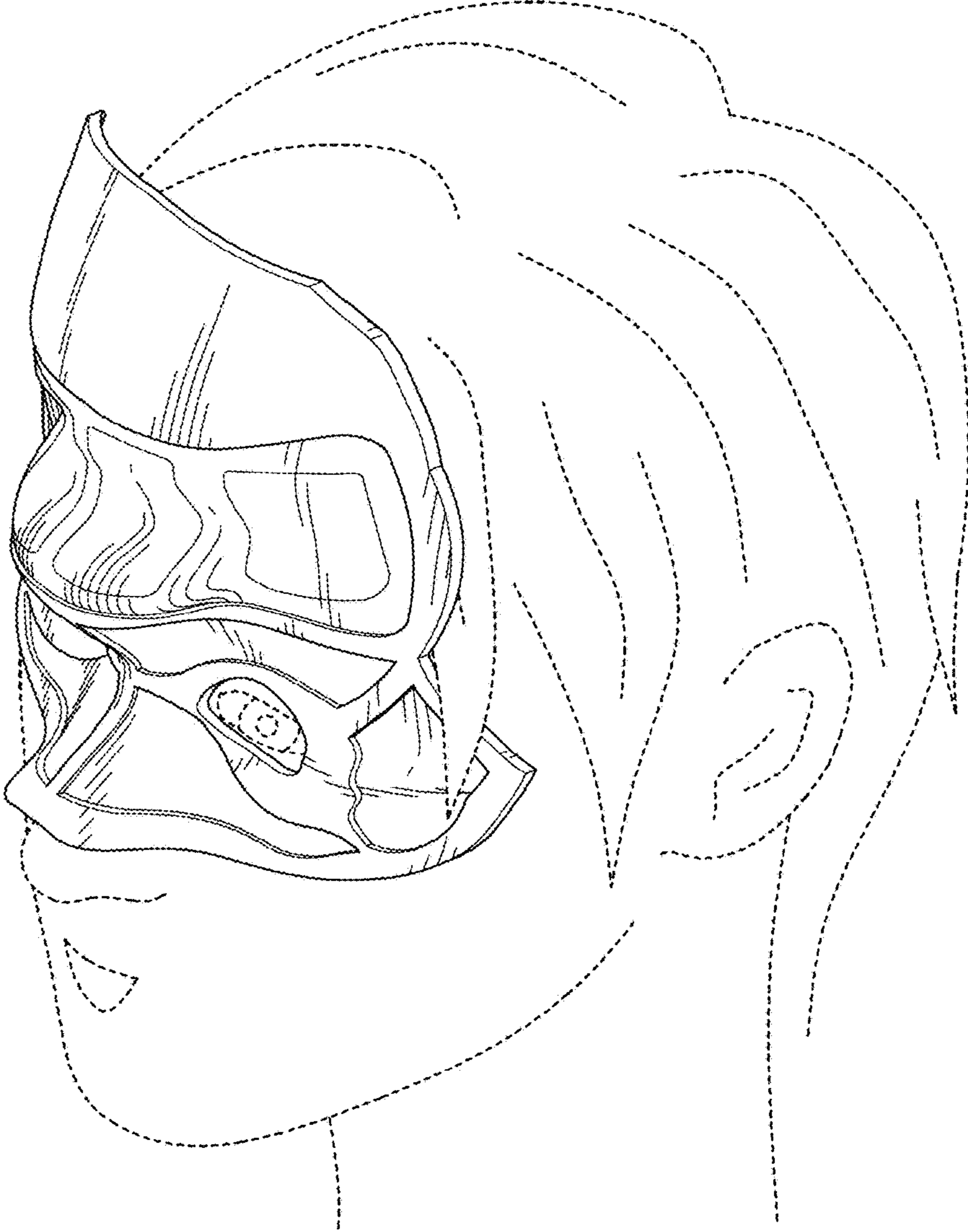

FIG.11

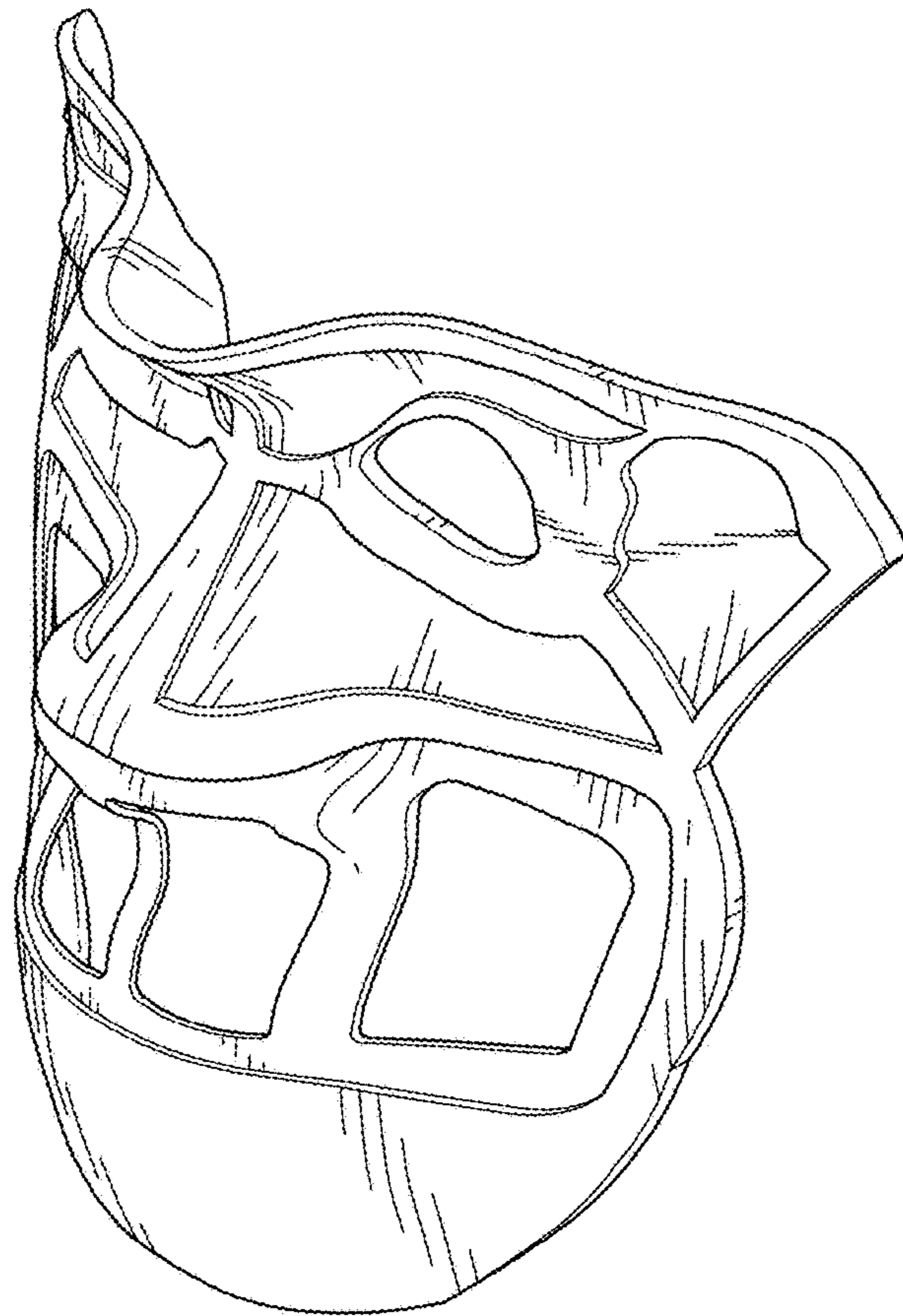

FIG.12

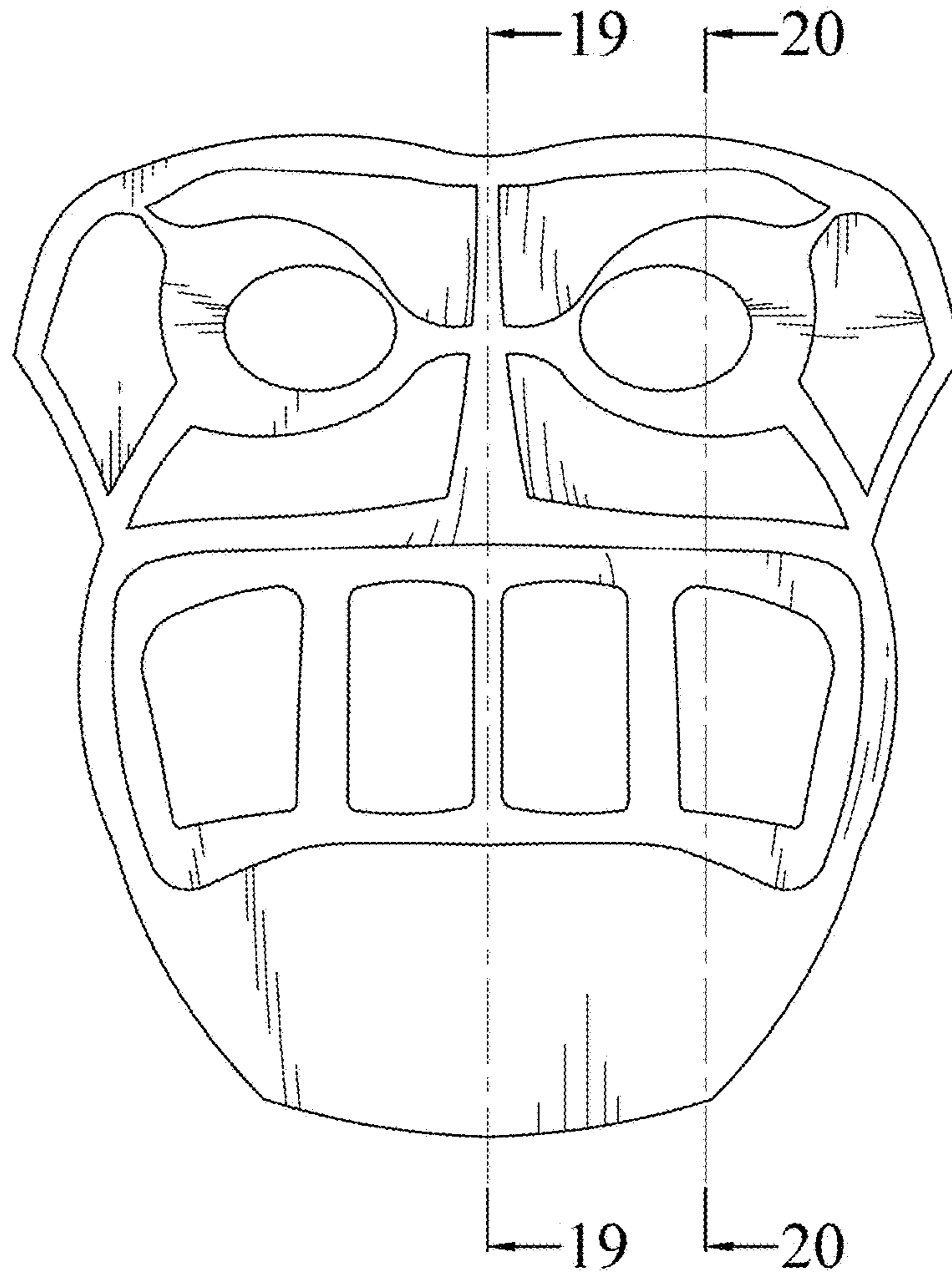

FIG.13

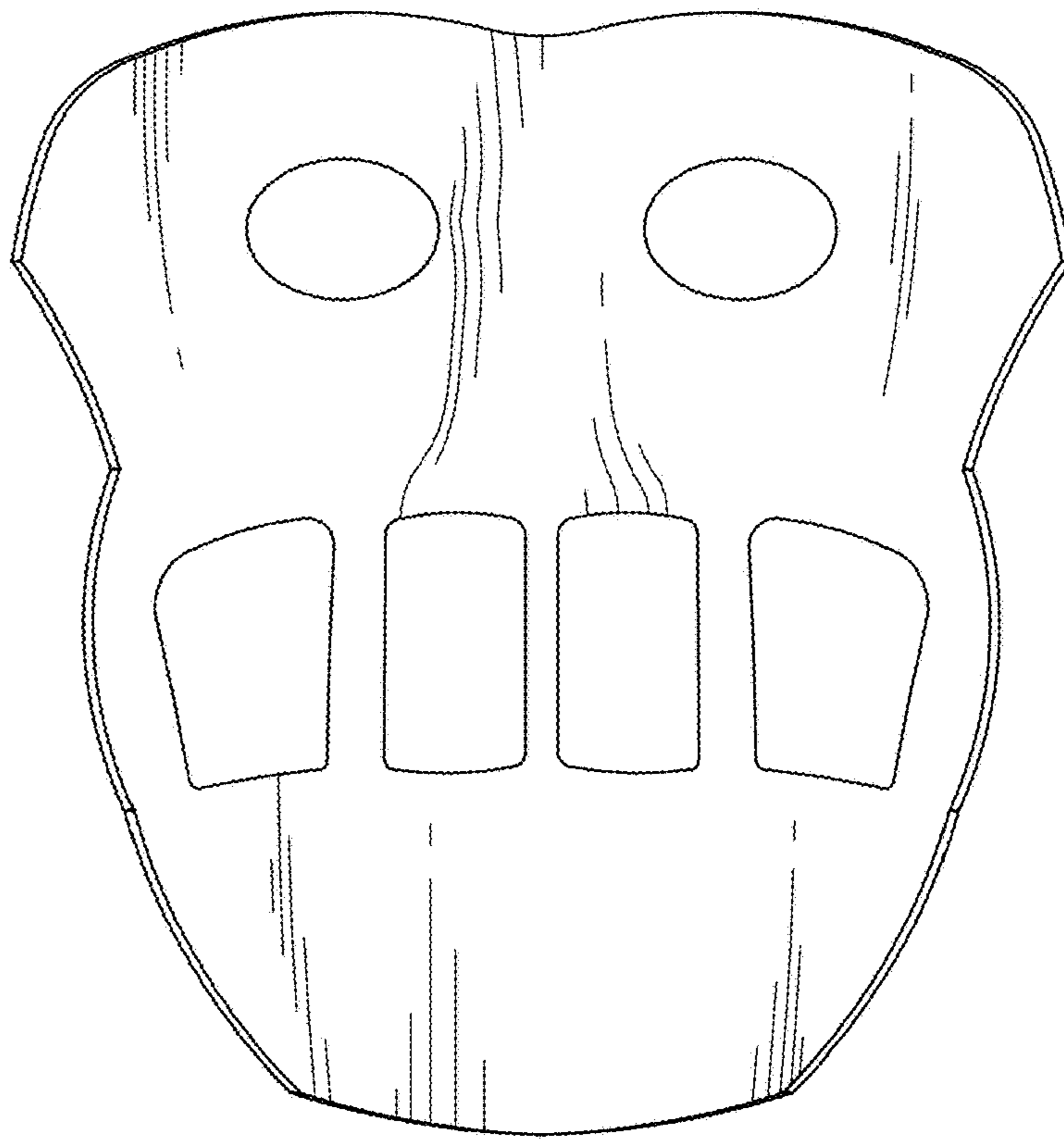

FIG.14

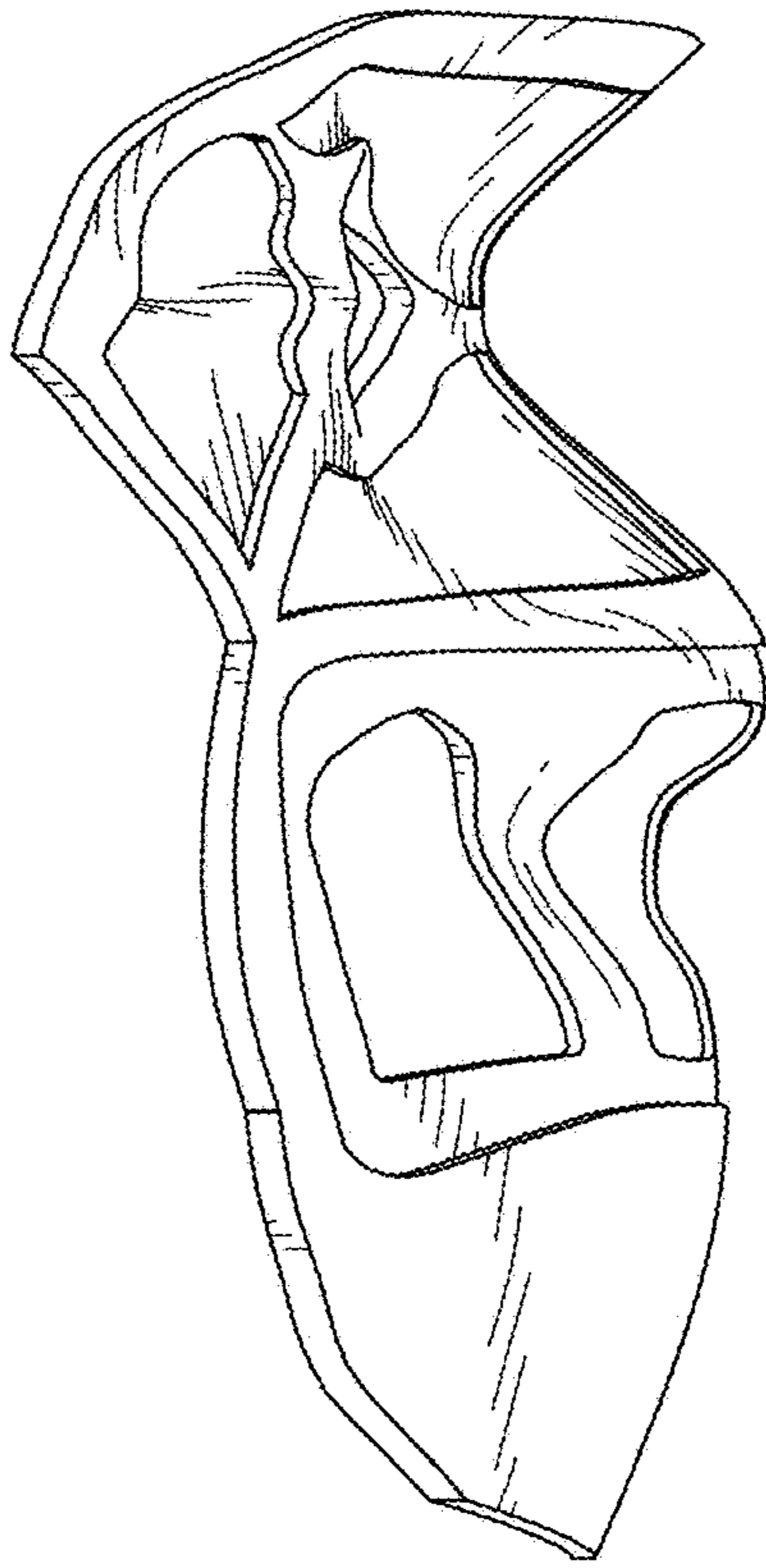

FIG.15

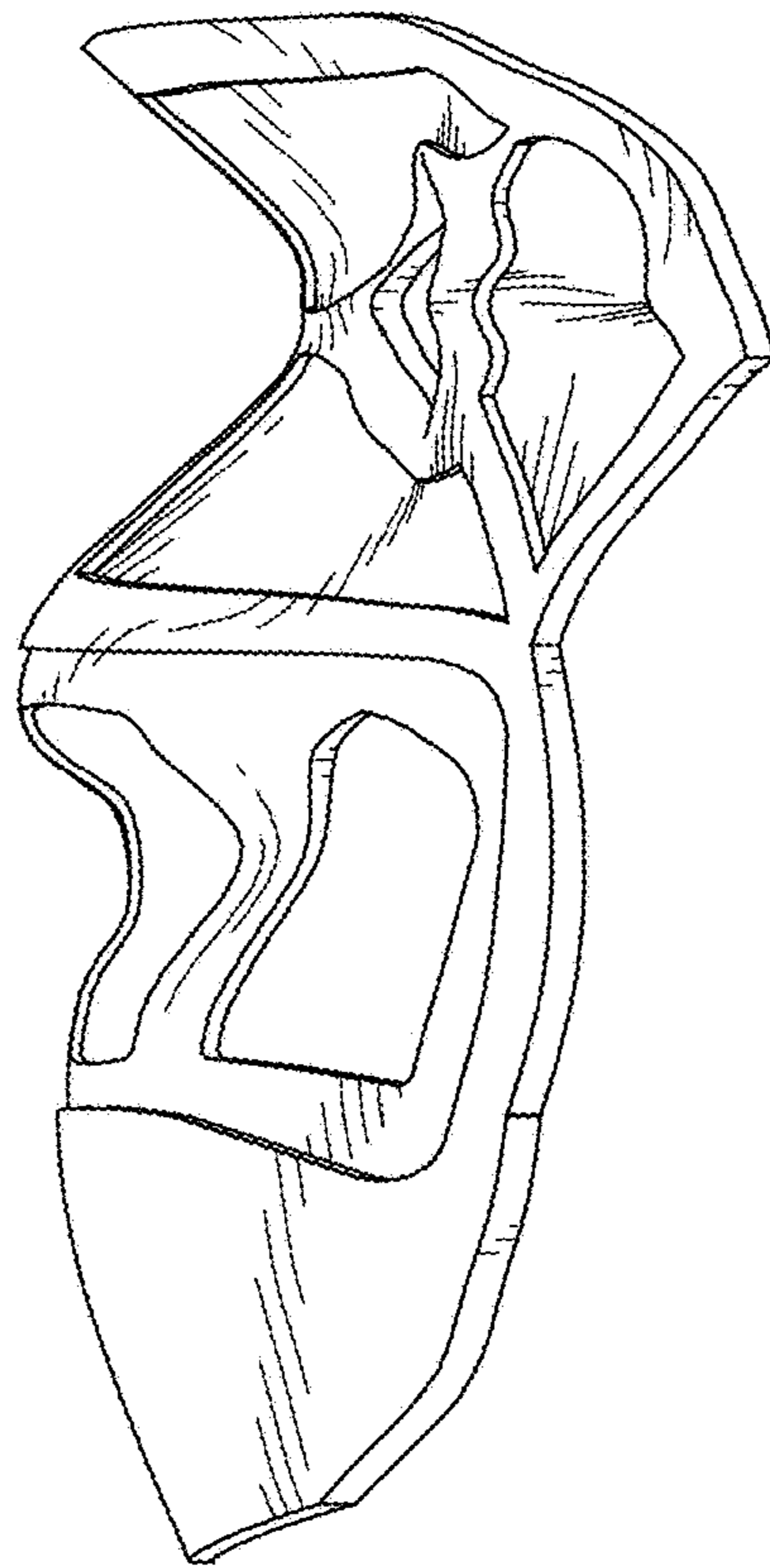

FIG.16



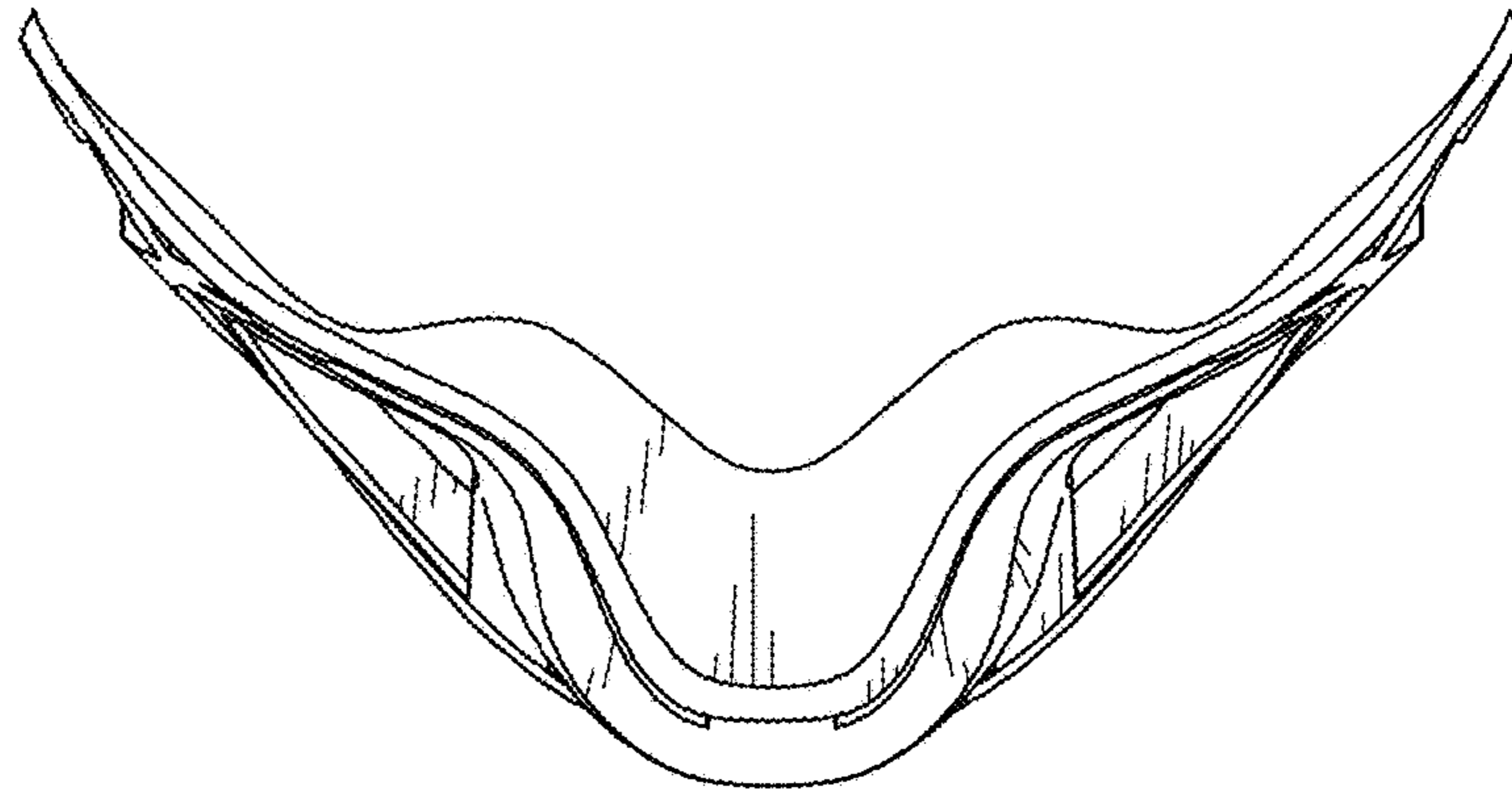

FIG. 17

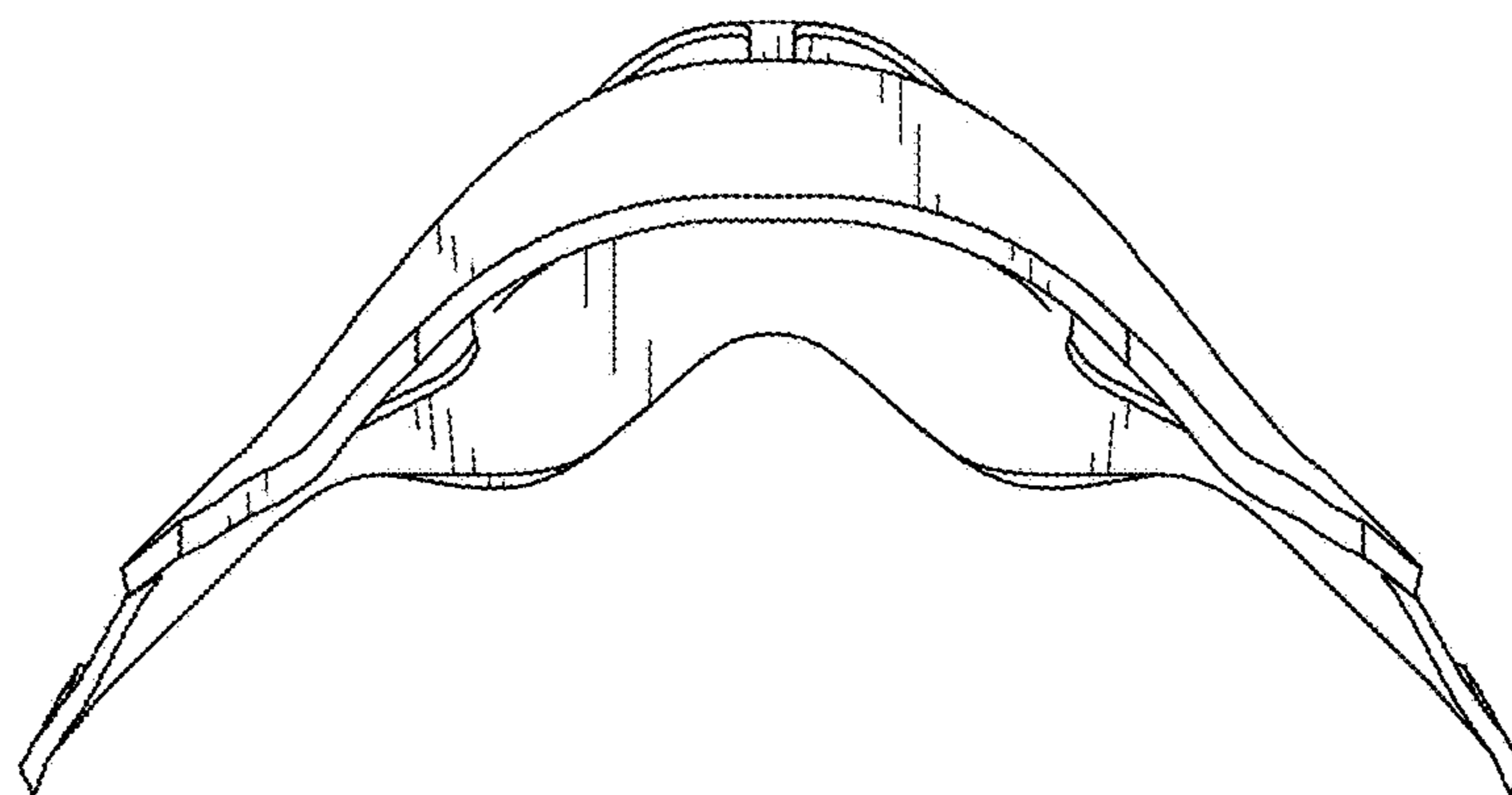

FIG. 18

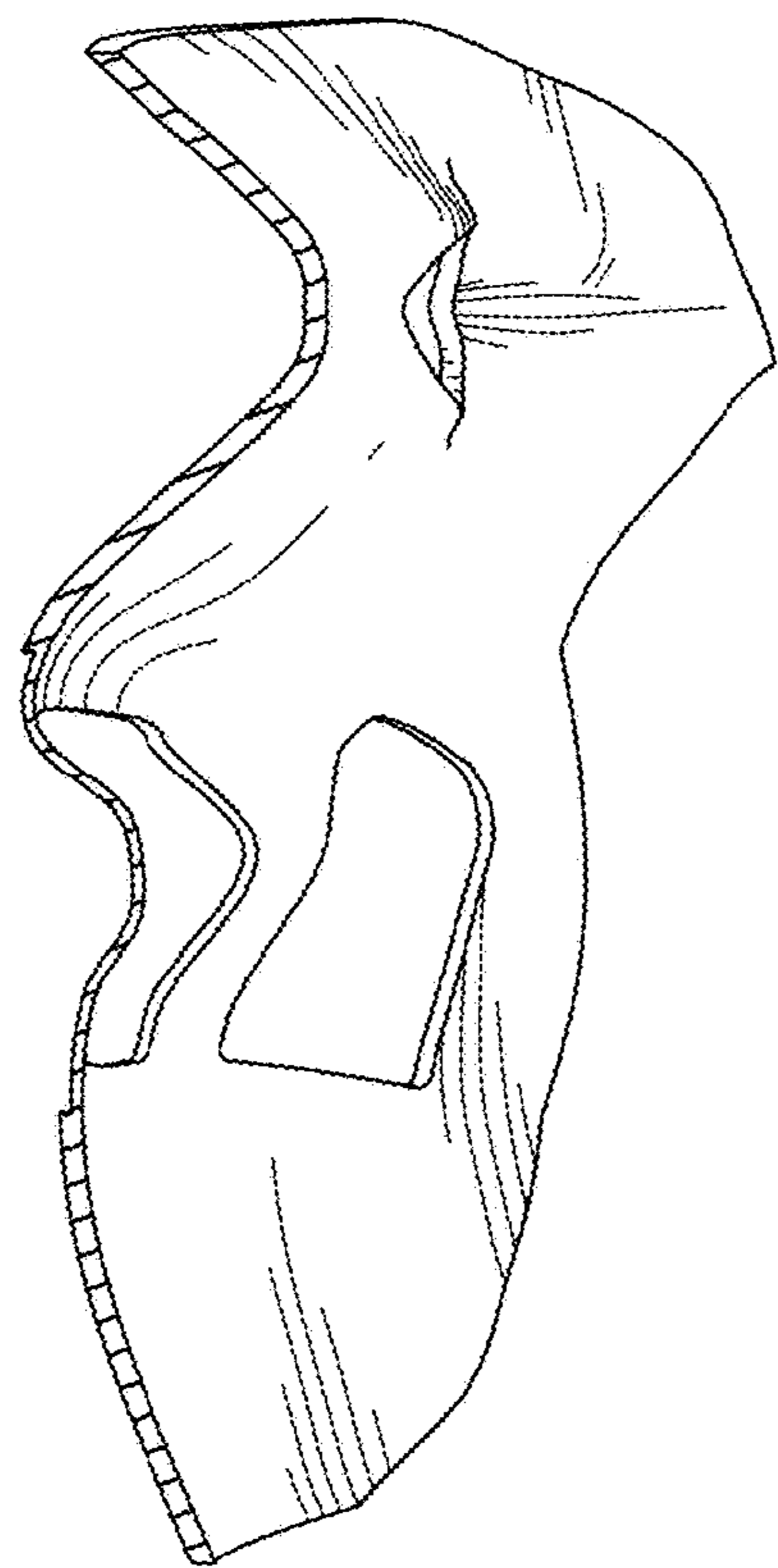

FIG. 19

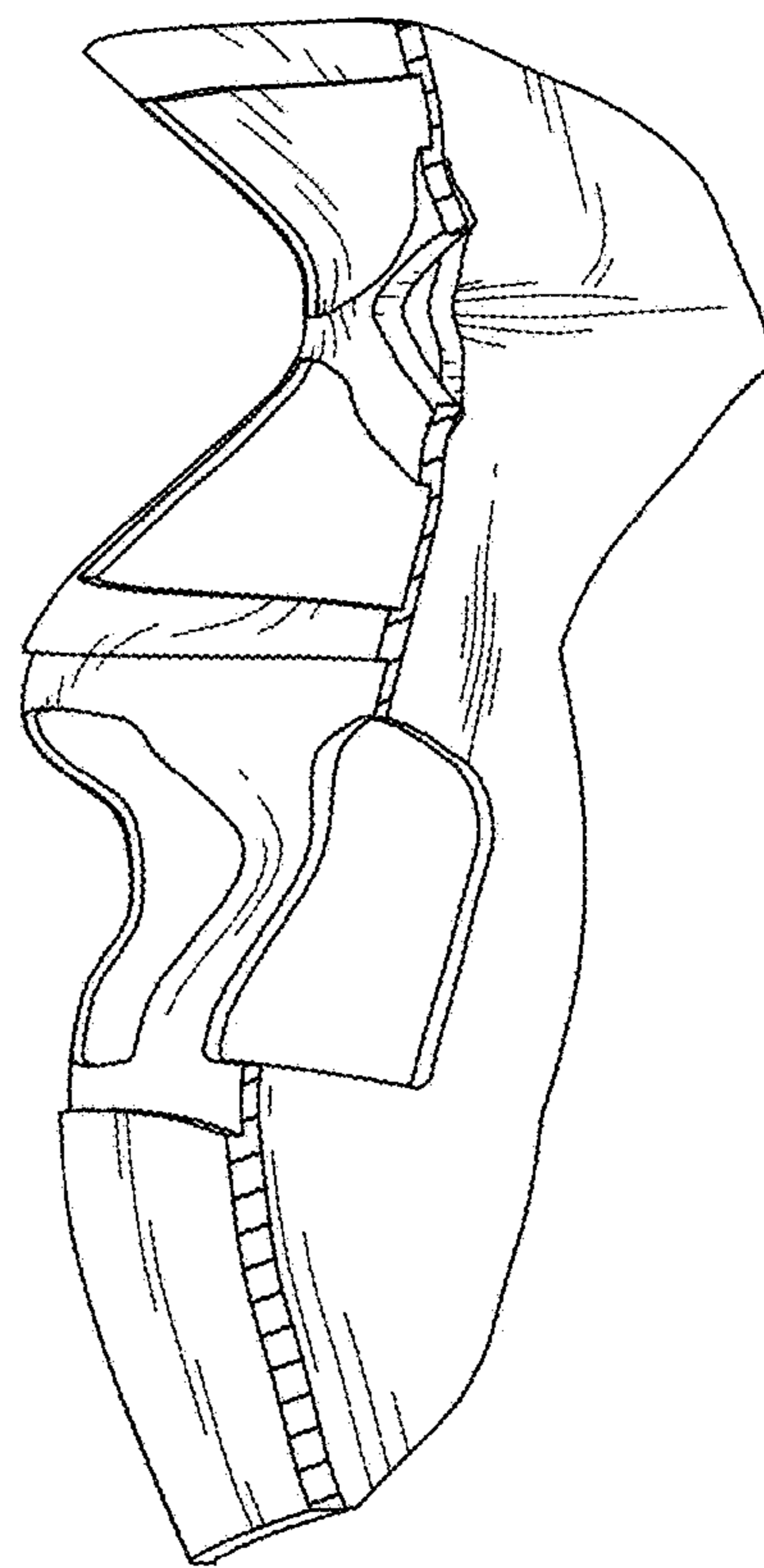

FIG. 20



FIG.21

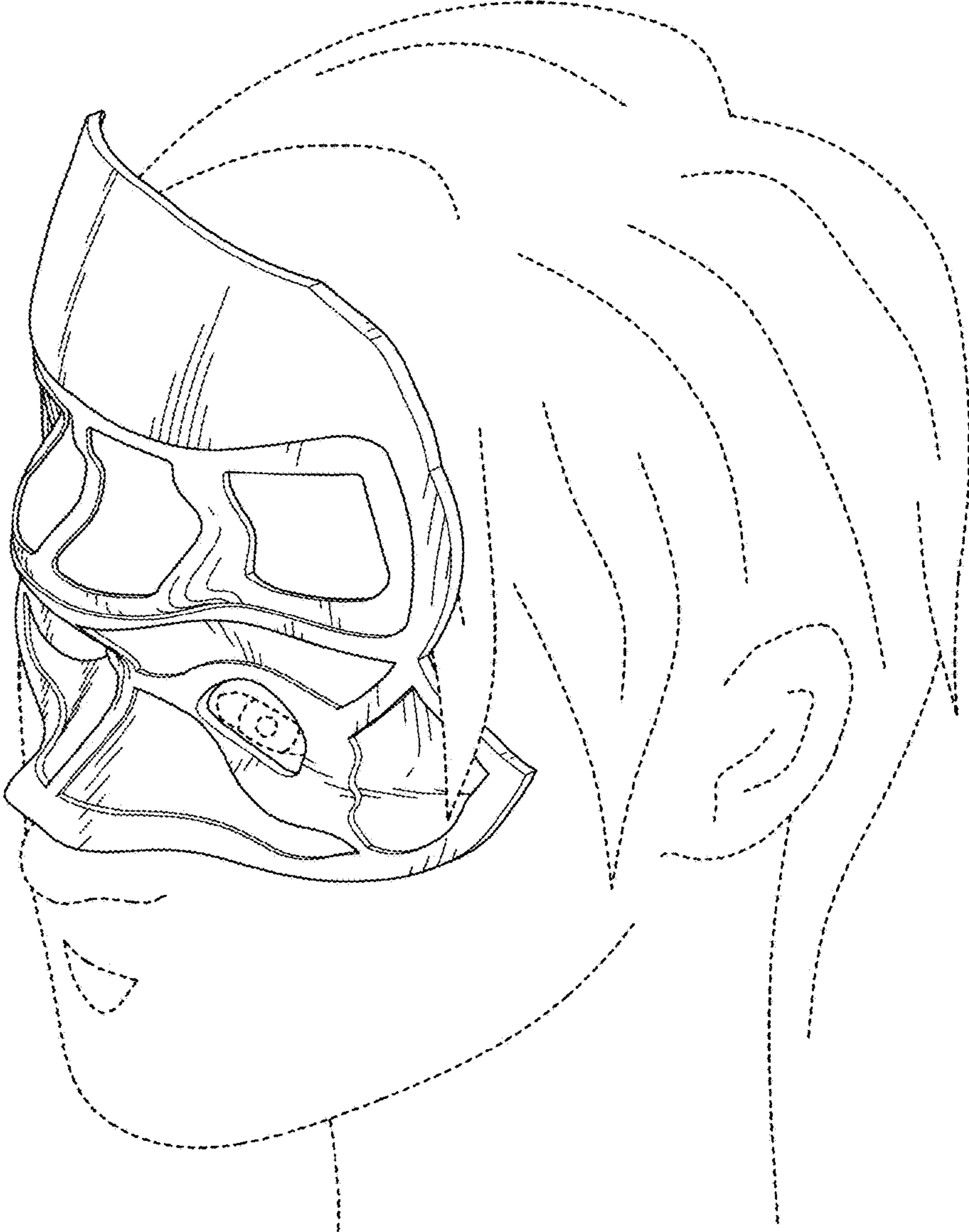

FIG.22

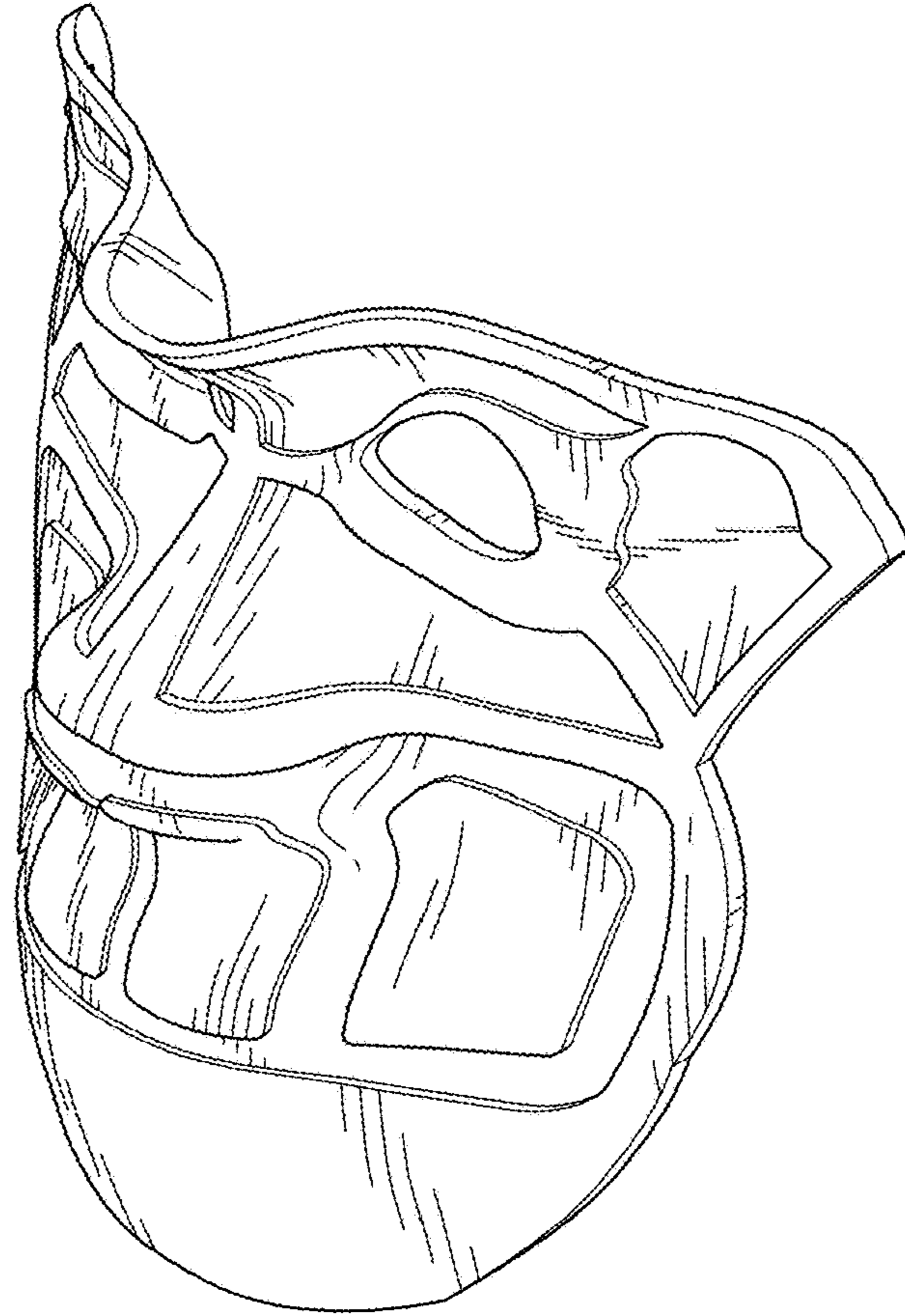

FIG.23

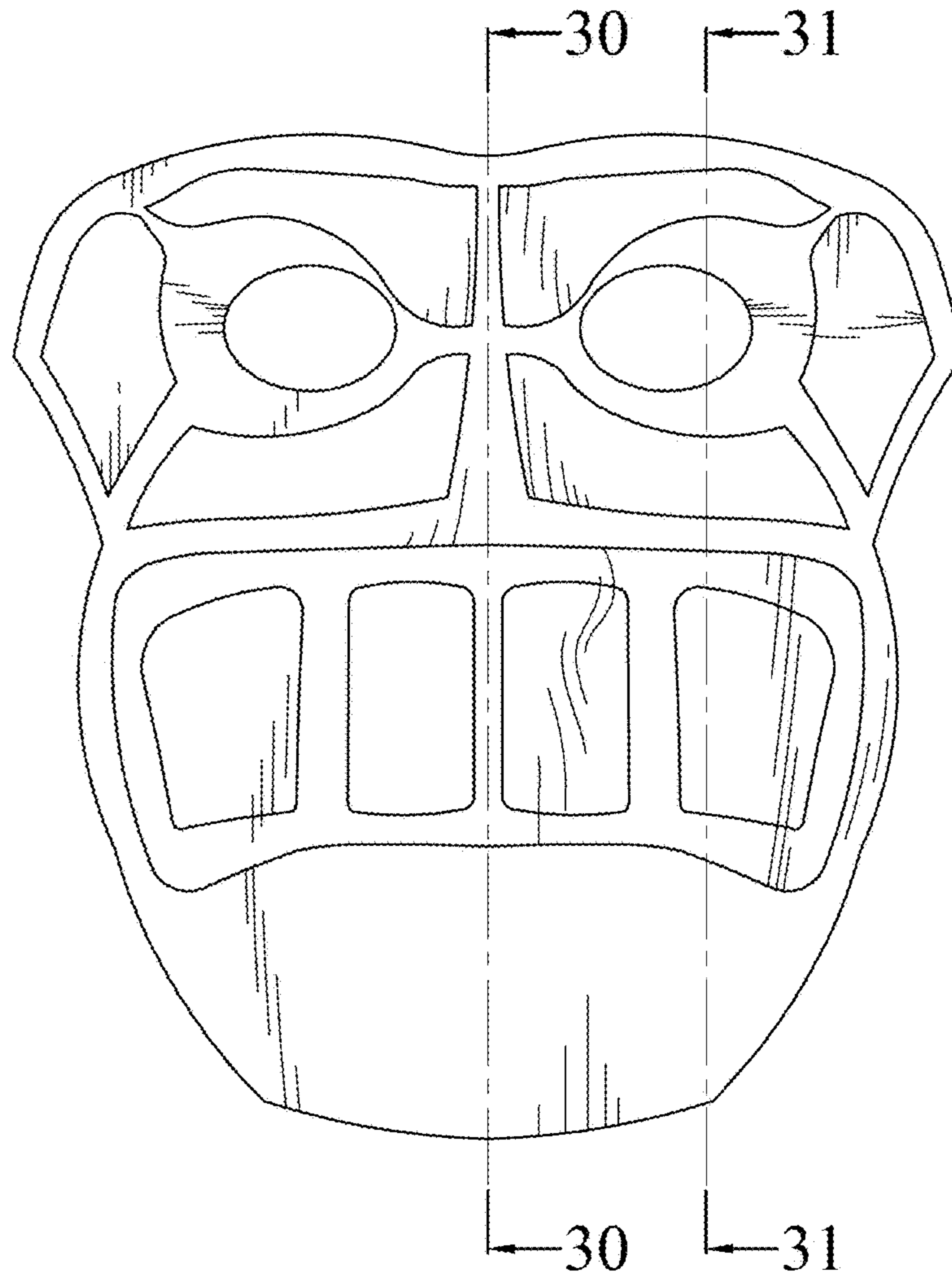

FIG.24

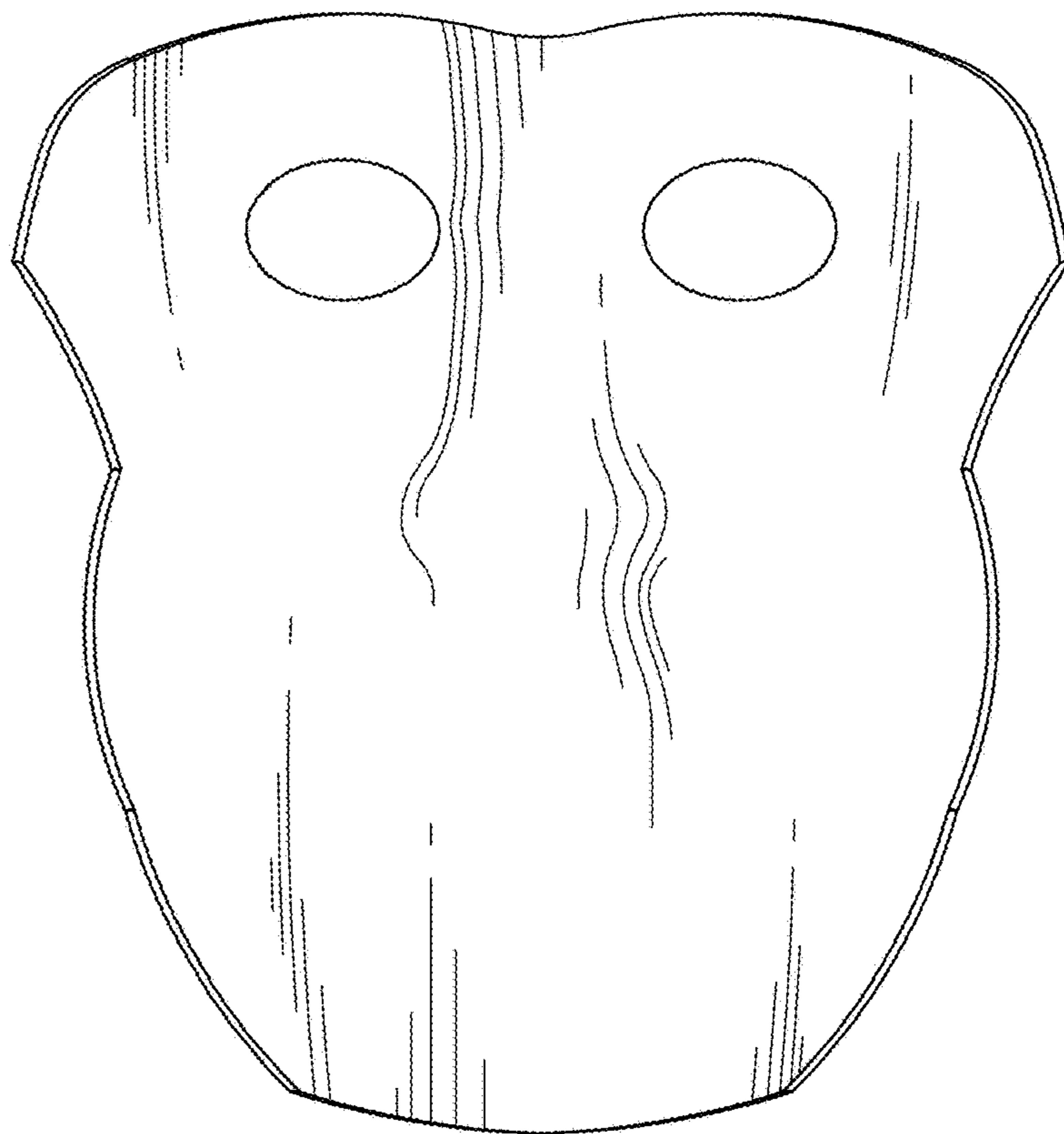

FIG.25

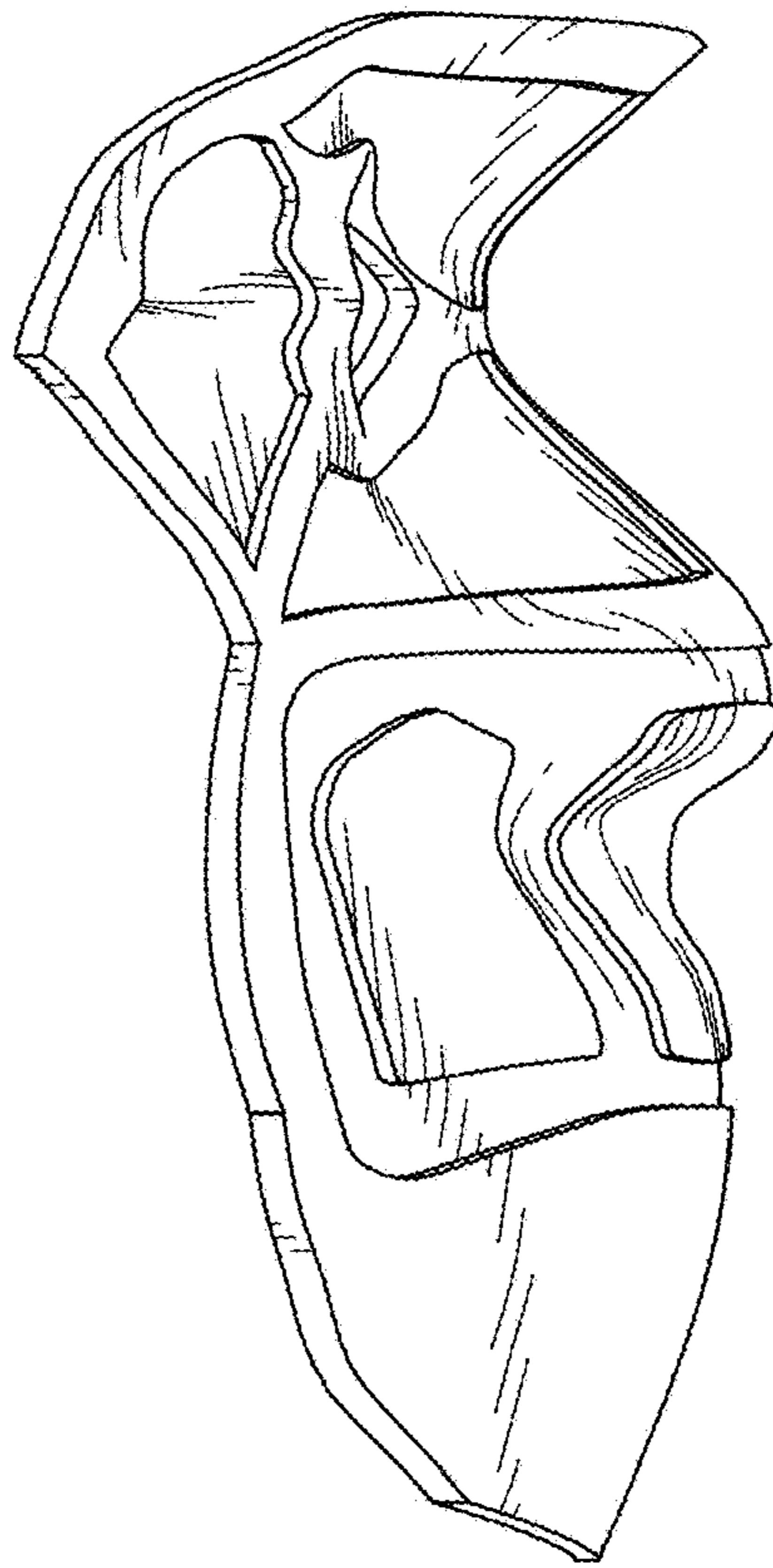

FIG.26



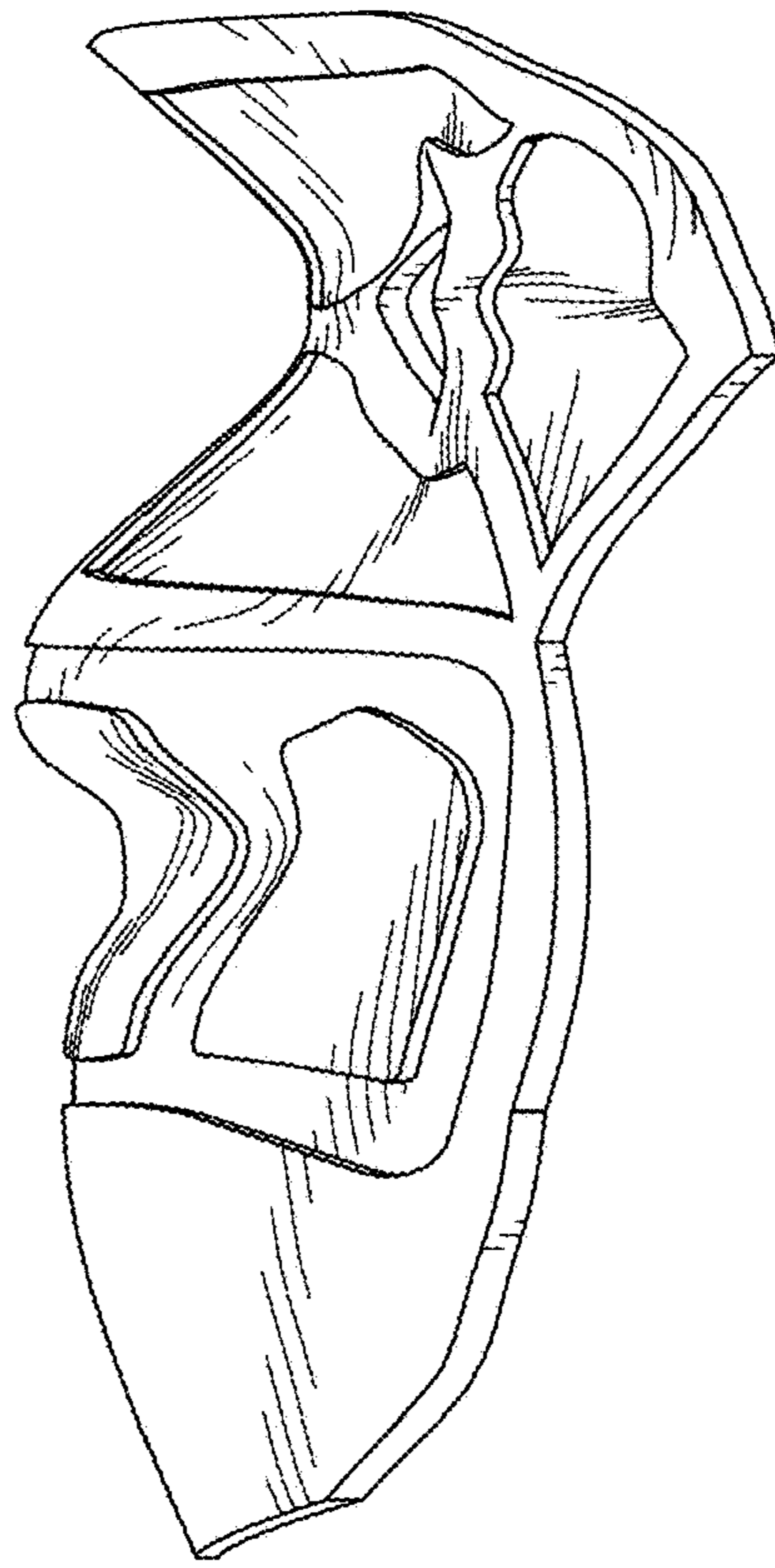

FIG.27

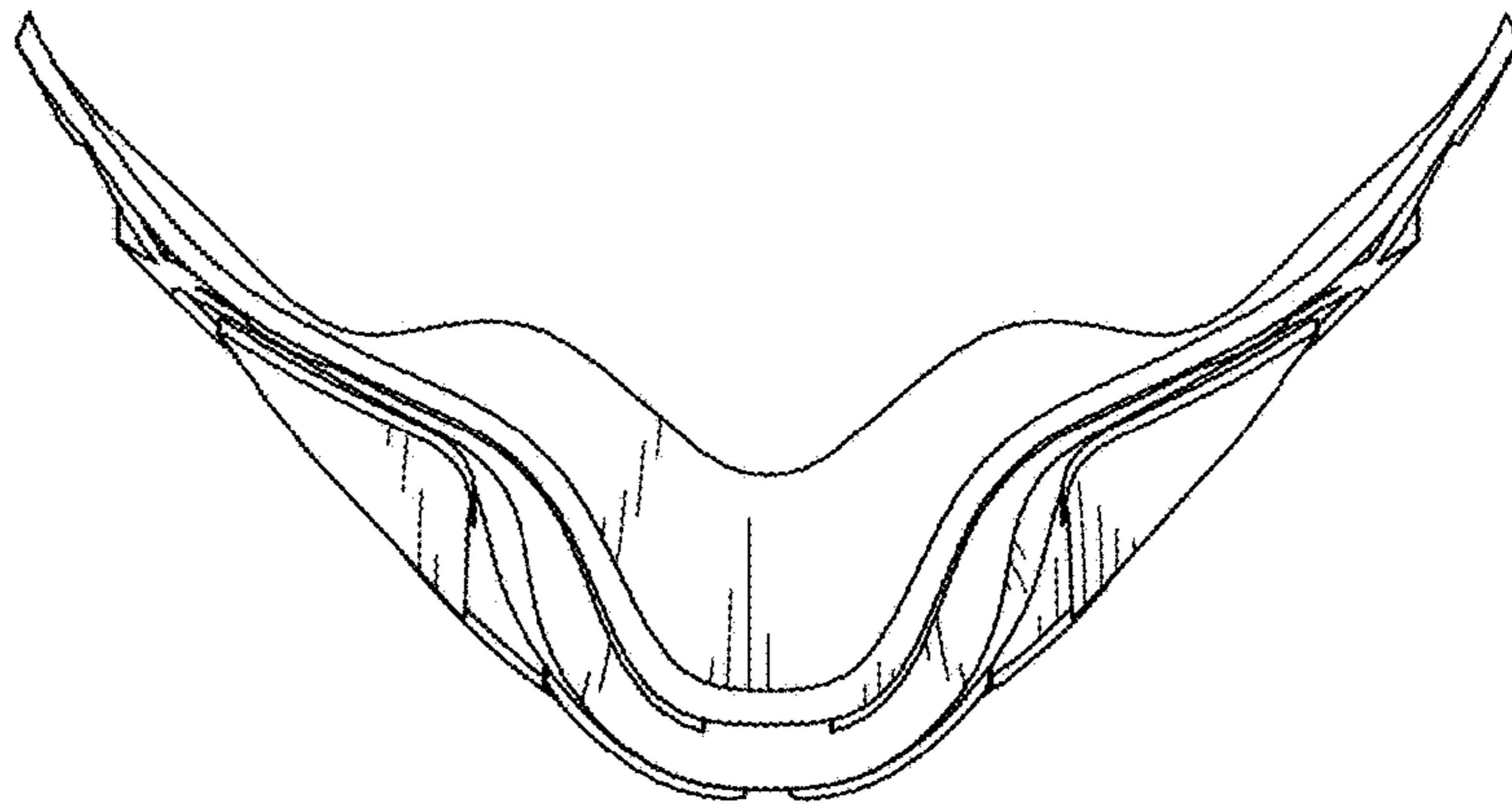

FIG. 28

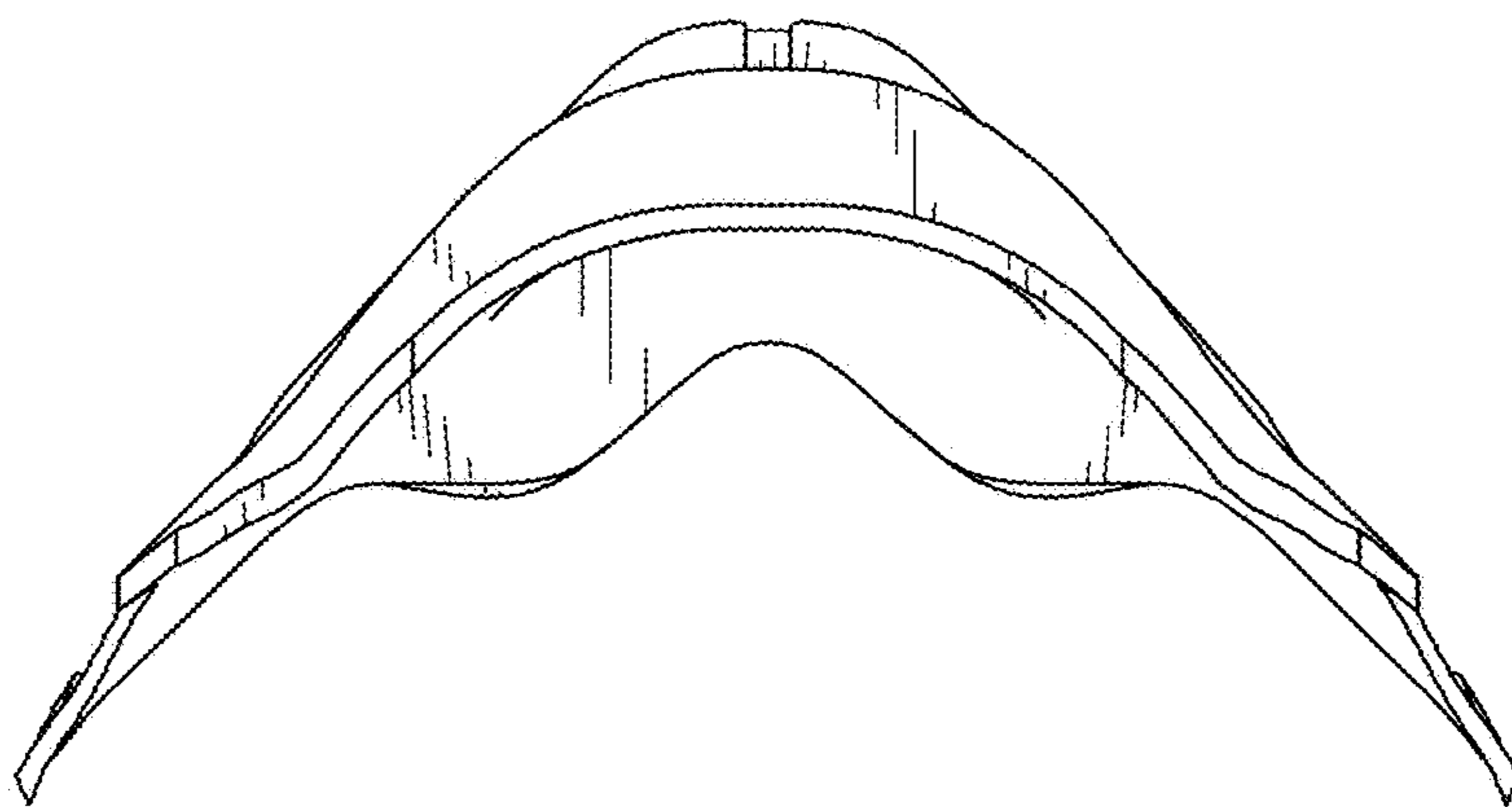

FIG. 29

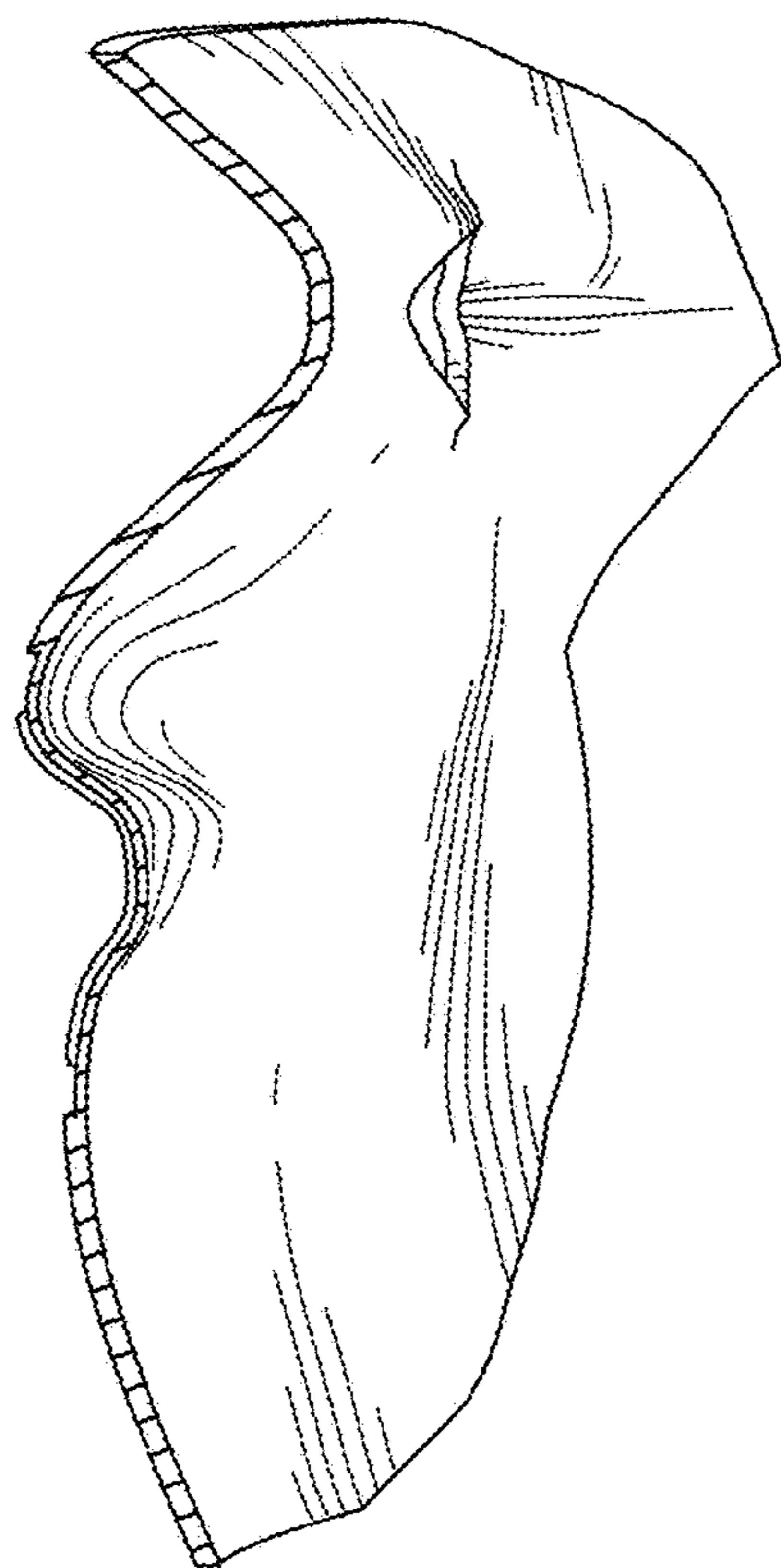

FIG.30

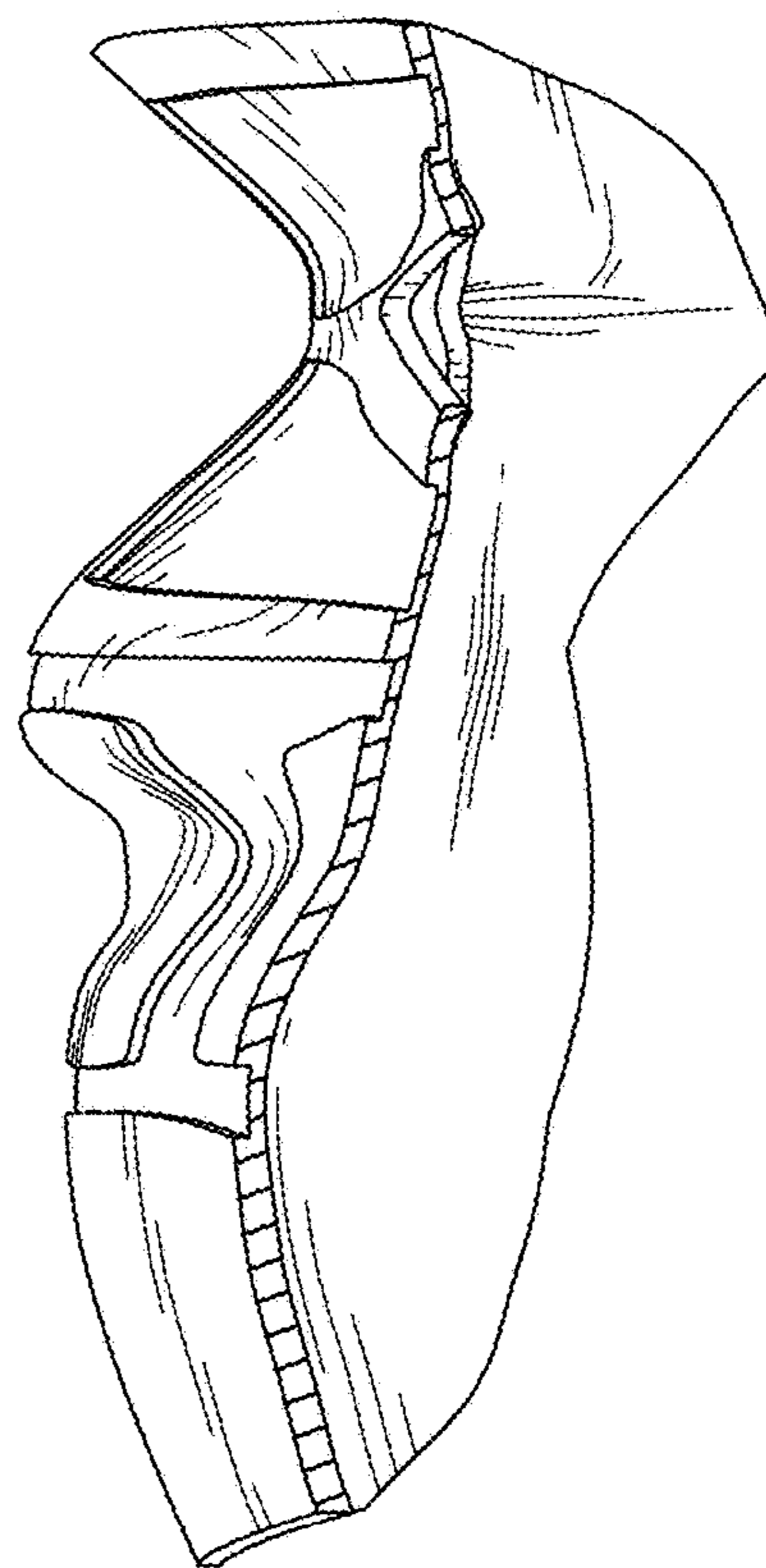

FIG.31



FIG.32

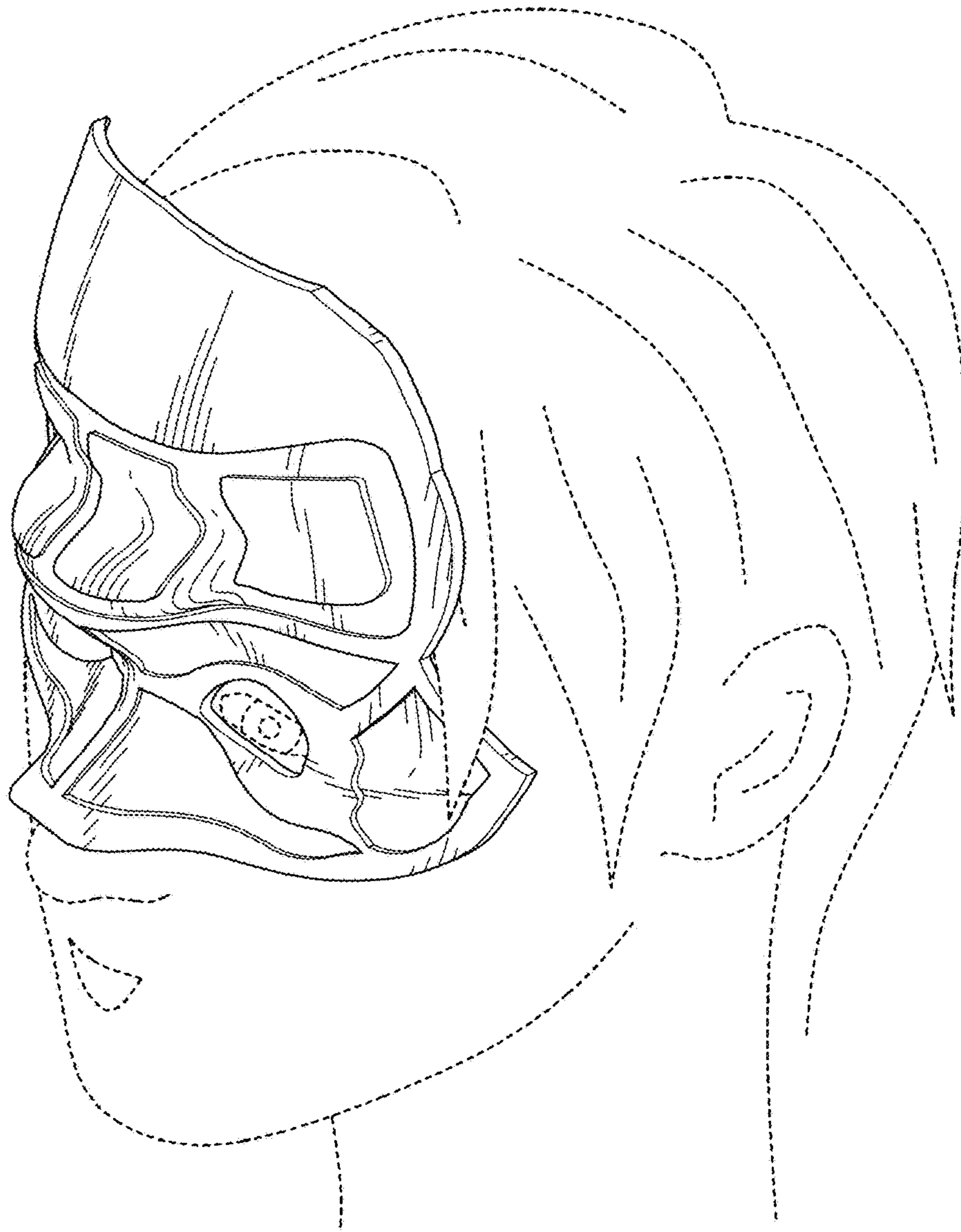

FIG.33