



US00D856996S

(12) **United States Design Patent** (10) **Patent No.:** **US D856,996 S**
Kim (45) **Date of Patent:** **** Aug. 20, 2019**

(54) **CASE FOR ELECTRONIC COMMUNICATIONS DEVICE**

(71) Applicant: **SPIGEN KOREA CO., LTD.**, Seoul (KR)

(72) Inventor: **Seungjoo Kim**, Seoul (KR)

(73) Assignee: **SPIGEN KOREA CO., LTD.**, Seoul (KR)

(**) Term: **15 Years**

(21) Appl. No.: **29/615,062**

(22) Filed: **Aug. 25, 2017**

(51) **LOC (12) Cl.** **14-03**

(52) **U.S. Cl.**
USPC **D14/250**

(58) **Field of Classification Search**
USPC D3/218, 232, 233, 239, 242, 245–251,
D3/269, 273, 301, 303; D13/103, 107,
(Continued)

(56) **References Cited**

U.S. PATENT DOCUMENTS

D619,361 S 7/2010 Andre et al.
D663,263 S * 7/2012 Gupta D13/103
(Continued)

OTHER PUBLICATIONS

Spigen, "Installation video of SGP Neo Hybrid Case", <https://www.youtube.com/watch?v=mVASro4MsEg>, Published on Oct. 30, 2009, Downloaded on Feb. 21, 2019.

(Continued)

Primary Examiner — Susan E Krakower
Assistant Examiner — L. A. Grabenstetter

(74) *Attorney, Agent, or Firm* — Heedong Chae; Lucem, PC

(57) **CLAIM**

The ornamental design for a case for electronic communications device, as shown and described.

DESCRIPTION

FIG. 1 is a front perspective view of a partially transparent case for electronic communications device, comprised of an outer frame and a transparent inner shell, showing my new design;

FIG. 2 is a rear perspective view thereof;

FIG. 3 is a front elevational view thereof;

FIG. 4 is a rear elevational view thereof;

FIG. 5 is a left side elevational view thereof;

FIG. 6 is a right side elevational view thereof;

FIG. 7 is a top plan view thereof;

FIG. 8 is a bottom plan view thereof;

FIG. 9 is a front perspective of the transparent inner shell of the case;

FIG. 10 is a rear perspective view of the transparent inner shell of the case;

FIG. 11 is a front perspective view of the outer frame of the case;

FIG. 12 is a rear perspective view of the outer frame of the case;

FIG. 13 is an exploded front perspective view thereof, showing the transparent inner shell and outer frame of the case; and,

FIG. 14 is an exploded rear perspective view thereof, showing the outer frame and transparent inner shell.

Although the case for electronic communications device in which the claimed design is embodied consists of an inner shell, and an outer frame, the claim is directed to the ornamental appearance of the claim in its entirety and does not extend to the ornamental appearance of each individual component.

The broken lines, and unshaded surfaces bounded by broken lines, depict parts of the article's appearance that form no part of the claimed design.

1 Claim, 14 Drawing Sheets

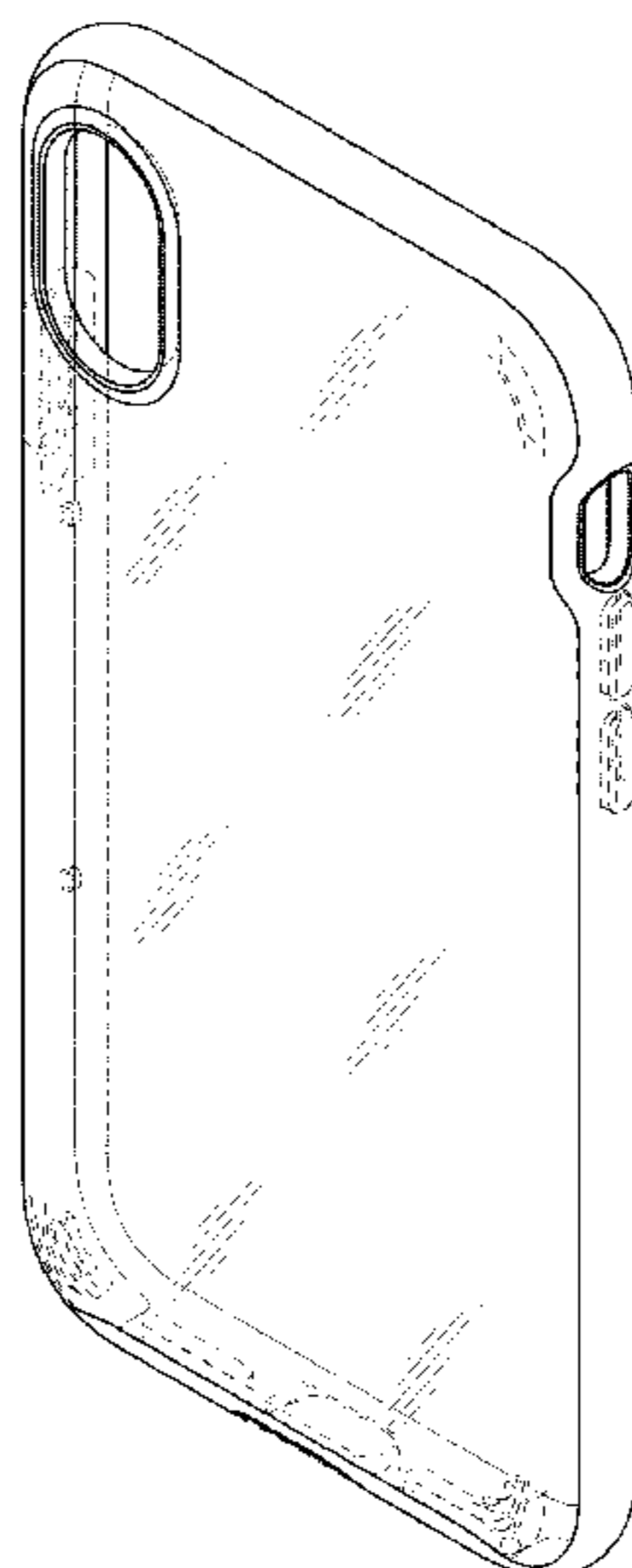

- (58) **Field of Classification Search**
 USPC D13/108, 119; D14/137, 138 R, 138 AA,
 D14/138 C, 138 G, 203.3–203.7, 217,
 D14/238.1, 247, 248, 250, 251–253, 440
 CPC H04B 1/3888; H04M 1/0283; H04M
 1/0202; A45C 1/06; A45C 2011/002;
 A45C 11/00; A45F 2005/028; A45F
 2200/0525
 See application file for complete search history.

(56) **References Cited**

U.S. PATENT DOCUMENTS

D669,071 S	10/2012	Akana et al.	
D670,281 S	11/2012	Corpuz et al.	
D671,930 S	12/2012	Akana et al.	
D676,837 S	2/2013	Rothbaum et al.	
D679,271 S	4/2013	Liu	
D706,254 S	6/2014	Chang	
D706,754 S *	6/2014	Goradesky	D14/250
D712,892 S	9/2014	Hong et al.	
D714,276 S	9/2014	Hu et al.	
D718,291 S	11/2014	Hong	
D721,360 S	1/2015	Laffon de Mazieres et al.	
D723,531 S *	3/2015	Katzke	D14/250
D746,275 S	12/2015	Mohammad	
D746,805 S *	1/2016	Kim	D14/250
D747,708 S *	1/2016	Roberts	D14/250
D756,345 S *	5/2016	Roberts	D14/250
D757,702 S	5/2016	Kanazawa	
D757,703 S	5/2016	Kanazawa	
D757,704 S *	5/2016	Roberts	D14/250
D760,710 S *	7/2016	Ozolins	D14/250
D761,774 S	7/2016	Liang	
D761,779 S *	7/2016	Tsai	D14/250
D763,841 S	8/2016	Kim	
D765,634 S	9/2016	McCray et al.	
D772,210 S	11/2016	Igarashi	
D772,854 S	11/2016	Igarashi	
D775,619 S	1/2017	Tien	
D776,104 S	1/2017	Tien	
D777,715 S	1/2017	Sawaya	
D780,167 S	2/2017	Tien	
D781,835 S	3/2017	Kim et al.	
D781,839 S	3/2017	Kim et al.	
D788,090 S	5/2017	Kim	
9,723,735 B1 *	8/2017	Kim	F16M 13/00
D800,105 S *	10/2017	Roberts	D14/250
D803,823 S *	11/2017	Feng	D14/250
2013/0257240 A1 *	10/2013	Hong	H04B 1/3888 312/223.1
2016/0101902 A1	4/2016	Kim	

OTHER PUBLICATIONS

Spigen, “Installation video of SGP Neo Hybrid2”, https://www.youtube.com/watch?v=y5_NdOVOfZo, Published on May 25, 2010, Downloaded on Feb. 21, 2019.

Spigen, “Installation video of SGP NEO HYBRID EX on iPhone 4”, <https://www.youtube.com/watch?v=Z-IRDIH1w0E>, Published on Sep. 3, 2010, Downloaded on Feb. 21, 2019.

Run Around Tech, “SGP Neo Hybrid Matte Series Case for the iPhone 4”, <https://www.youtube.com/watch?v=fOH74451I-8>, Published on Sep. 22, 2010, Downloaded on Aug. 15, 2018.

“SGP iPhone 4 Case Neo Hybrid Matte Series Gun Metal”, <https://www.amazon.co.uk/dp/B004F1IQ7E>, Date first available at Amazon.co.uk of Dec. 3, 2010, Downloaded on Aug. 15, 2018.

Spigen, “Installation video of SGP NEO HYBRID on iPhone 4”, <https://www.youtube.com/watch?v=GnVusVoDrOc>, Published on Dec. 15, 2010, Downloaded on Feb. 21, 2019.

Spigen, “Installation video of SGP Case NEO HYBRID EX on Galaxy S2”, <https://www.youtube.com/watch?v=ZPhSIAUxXWg>, Published on Aug. 24, 2011, Downloaded on Feb. 21, 2019.

Spigen, “Spigen SGP Neo Hybrid 2S iPhone 4s & Neo Hybrid Galaxy S2 LTE”, <https://www.youtube.com/watch?v=SLzDq11dyiY>, Published on Nov. 21, 2011, Downloaded on Feb. 20, 2019.

Spigen, “Spigen SGP NEO HYBRID case for iphone 4S”, <https://www.youtube.com/watch?v=nLvPhRyX3g>, Published on Nov. 22, 2011, Downloaded on Feb. 20, 2019.

Spigen, “Neo Hybrid Case for Galaxy S3”, <https://www.youtube.com/watch?v=IgpahRniVkU>, Published on Jun 27, 2012, Downloaded on Feb. 21, 2019.

Spigen, “Installation video of Spigen SGP Case NEO HYBRID EX on iPhone 5”, <https://www.youtube.com/watch?v=X2GAS9FT6U4>, Published on Oct. 11, 2012, Downloaded on Feb. 20, 2019.

“Spigen Neo Hybrid Galaxy S4 Case with Flexible Inner Protection and Reinforced Hard Bumper Frame for Galaxy S4 2013—Dante Red”, <https://www.amazon.com/dp/B00BYJXI1Y>, Earliest review date of May 9, 2013, Downloaded on Jan. 22, 2019.

Metagamers, “Spigen Neo Hybrid iPhone 5 & 5s Case Review”, <https://www.youtube.com/watch?v=vTYZfSmal>, Published on Jul. 21, 2013, Downloaded on Feb. 21, 2019.

“Spigen Neo Hybrid Galaxy S5 Case with Flexible Inner Protection and Reinforced Hard Bumper Frame for Samsung Galaxy S5 2014—Electric Blue”, <https://www.amazon.com/dp/B00I3UWJJY>, Earliest review date of Apr. 12, 2014, Downloaded on Jan. 22, 2019.

“iPhone 6s Case, Spigen [Neo Hybrid EX] Premium Bumper [Rose Gold] Clear TPU/PC Frame Slim Dual Layer Premium Case for iPhone 6 (2014)/6s (2015)—Rose Gold (SGP11725)”, <https://www.amazon.com/dp/B012PKV30S>, Earliest review date of Aug. 28, 2015.

Danny Winget, “Spigen SGP Neo Hybrid for Galaxy Note 3 Review”, <https://www.youtube.com/watch?v=W80JtBDSckk>, Published on Nov. 3, 2013.

“Spigen Neo Hybrid Carbon Galaxy S6 Edge Plus Case with Carbon Fiber Design and Reinforced Hard Bumper Frame for Galaxy S6 Edge Plus 2015—Dante Red”, <https://www.amazon.com/dp/B010MWHZSO>, Earliest review date of Aug. 18, 2015.

“Spigen Neo Hybrid Carbon iPhone 6s Case with Carbon Fiber Design and Reinforced Hard Bumper Frame for Apple iPhone 6s/iPhone 6 (2015)—Reventon Yellow”, <https://www.amazon.com/dp/B010MVJ508>, Earliest review date of Sep. 1, 2015.

“Spigen Neo Hybrid Carbon iPhone 6S Plus Case with Carbon Fiber Design and Reinforced Hard Bumper Frame for iPhone 6S Plus 2015—Gunmetal”, <https://www.amazon.com/dp/B010MVRGMQ>, Earliest review date of Sep. 11, 2015.

“Spigen Neo Hybrid CC Galaxy S6 Case with Flexible Inner Casing and Reinforced Hard Bumper Frame for Galaxy S6 2015—Satin Silver”, <https://www.amazon.com/dp/B00UMDOZLU>, Earliest review date of Mar. 25, 2015.

“Spigen Neo Hybrid CC Galaxy S6 Edge Case with Flexible Inner Casing and Reinforced Hard Bumper Frame for Galaxy S6 Edge 2015—Blue Topaz”, <https://www.amazon.com/dp/B00USAPGKQ>, Earliest review date of Apr. 4, 2015.

“Spigen Neo Hybrid Crystal Galaxy Note 5 Case with Flexible Inner Casing and Reinforced Hard Bumper Frame for Galaxy Note 5 2015—Champagne Gold”, <https://www.amazon.com/dp/B010MWIG1K>, Earliest review date of Aug. 22, 2015.

“Spigen Neo Hybrid EX iPhone 6 Case with Flexible Inner Bumper and Reinforced Hard Frame for iPhone 6S/iPhone 6—EX Satin Silver”, <https://www.amazon.com/dp/B00LL6RZ3C>, Earliest review date of Sep. 6, 2014.

“Spigen Neo Hybrid EX iPhone 6S Plus Case with Flexible Inner Bumper and Reinforced Hard Frame for iPhone 6S Plus/iPhone 6 Plus—Champagne Gold”, <https://www.amazon.com/dp/B010MVRRL6>, Earliest review date of Sep. 4, 2015.

“Spigen Neo Hybrid EX Nexus 6P Case with Flexible Inner Bumper and Reinforced Hard Frame for Nexus 6P 2015—Gunmetal”, <https://www.amazon.com/dp/B0184I8Z4W>, Earliest review date of Oct. 20, 2015.

“Spigen Neo Hybrid Galaxy S6 Case with Flexible Inner Protection and Reinforced Hard Bumper Frame for Galaxy S6 2015—Satin Silver”, <https://www.amazon.com/dp/B00QU4Q31A>, Earliest review date of Mar. 6, 2015.

“Spigen Neo Hybrid Galaxy S6 Edge Case with Flexible Inner Protection and Reinforced Hard Bumper Frame for Galaxy S6 Edge 2015—Gunmetal”, <https://www.amazon.com/dp/B00SV635BG>, Earliest review date of Mar. 19, 2015.

(56)

References Cited

OTHER PUBLICATIONS

“Spigen Neo Hybrid iPhone 6 Case with Flexible Inner Protection and Reinforced Hard Bumper Frame for iPhone 6S/iPhone 6—Gunmetal”, <https://www.amazon.com/dp/B00LL6ZPXY>, Earliest review date of Aug. 28, 2014.

“Spigen Neo Hybrid Nexus 6 Case with Flexible Inner Protection and Reinforced Hard Bumper Frame for Google Nexus 6 2014—Dante Red”, <https://www.amazon.com/dp/B00OH4HKGC>, Earliest review date of Nov. 16, 2014.

“Spigen Neo Hybrid Galaxy S7 Case with Flexible Inner Protection and Reinforced Hard Bumper Frame for Samsung Galaxy S7 2016—Gunmetal”, <https://www.amazon.com/dp/B0161I6J0E>, Earliest review date of Feb. 27, 2016.

“Spigen Neo Hybrid Crystal Galaxy S7 Case with Flexible Inner Casing and Reinforced Hard Bumper Frame for Samsung Galaxy S7 2016—Champagne Gold”, <https://www.amazon.com/dp/B01B29WCOY>, Earliest review date of Mar. 3, 2016.

“Spigen Neo Hybrid Crystal Galaxy S7 Edge Case with Flexible Inner Casing and Reinforced Hard Bumper Frame for Samsung Galaxy S7 Edge 2016—Satin Silver”, <https://www.amazon.com/dp/B01A7IDQV4>, Earliest review date of Feb. 22, 2016.

“Spigen Neo Hybrid Crystal iPhone SE Case with Flexible Inner Casing and Reinforced Hard Bumper Frame for iPhone SE 2016—Rose Gold”, <https://www.amazon.com/dp/B01BEJB7TI>, Earliest review date of Apr. 7, 2016.

“Spigen Neo Hybrid Crystal LG G5 Case with Flexible Inner Casing and Reinforced Hard Bumper Frame for LG G5 2016—Champagne Gold”, <https://www.amazon.com/dp/B01B1GQKIC>, Earliest review date of Apr. 17, 2016.

“Spigen Neo Hybrid Galaxy S7 Edge Case with Flexible Inner Protection and Reinforced Hard Bumper Frame for Samsung Galaxy S7 Edge 2016—Satin Silver”, <https://www.amazon.com/dp/B01B1I6JMM>, Earliest review date of Feb. 27, 2016.

“Spigen Neo Hybrid iPhone SE Case with Flexible Inner Protection and Reinforced Hard Bumper Frame for iPhone SE 2016—Gunmetal”, <https://www.amazon.com/dp/B01BEJBBSK>, Earliest review date of Apr. 6, 2016.

“Spigen Neo Hybrid OnePlus 3 Case/OnePlus 3T Case with Flexible Inner Protection and Reinforced Hard Bumper Frame for OnePlus 3 2016—Gunmetal”, <https://www.amazon.com/dp/B01H3PF76Q>, Earliest review date of Aug. 9, 2016.

“Spigen Neo Hybrid iPhone 6S Case with Flexible Inner Protection and Reinforced Hard Bumper Frame for iPhone 6S 2015—Gunmetal”, <https://www.amazon.com/dp/B010MVIZTE>, Earliest review date of Sep. 1, 2015.

* cited by examiner

FIG. 1

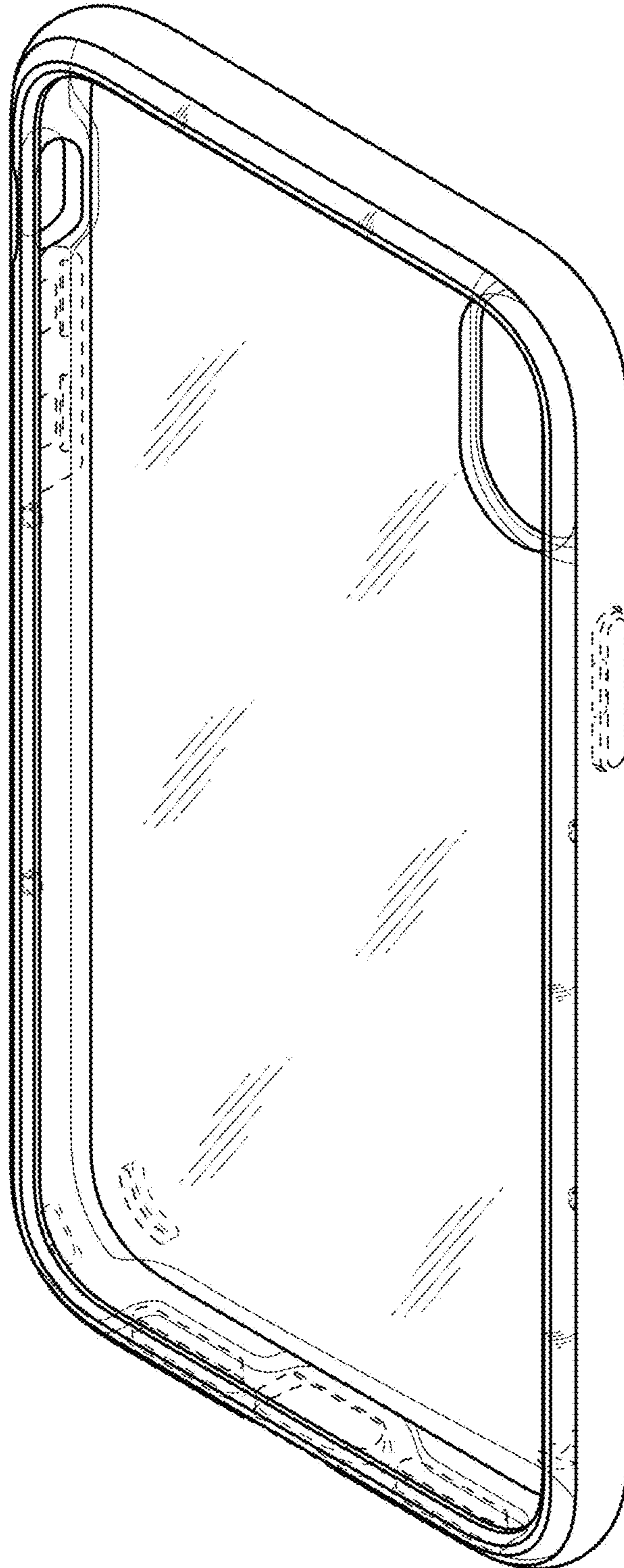

FIG. 2

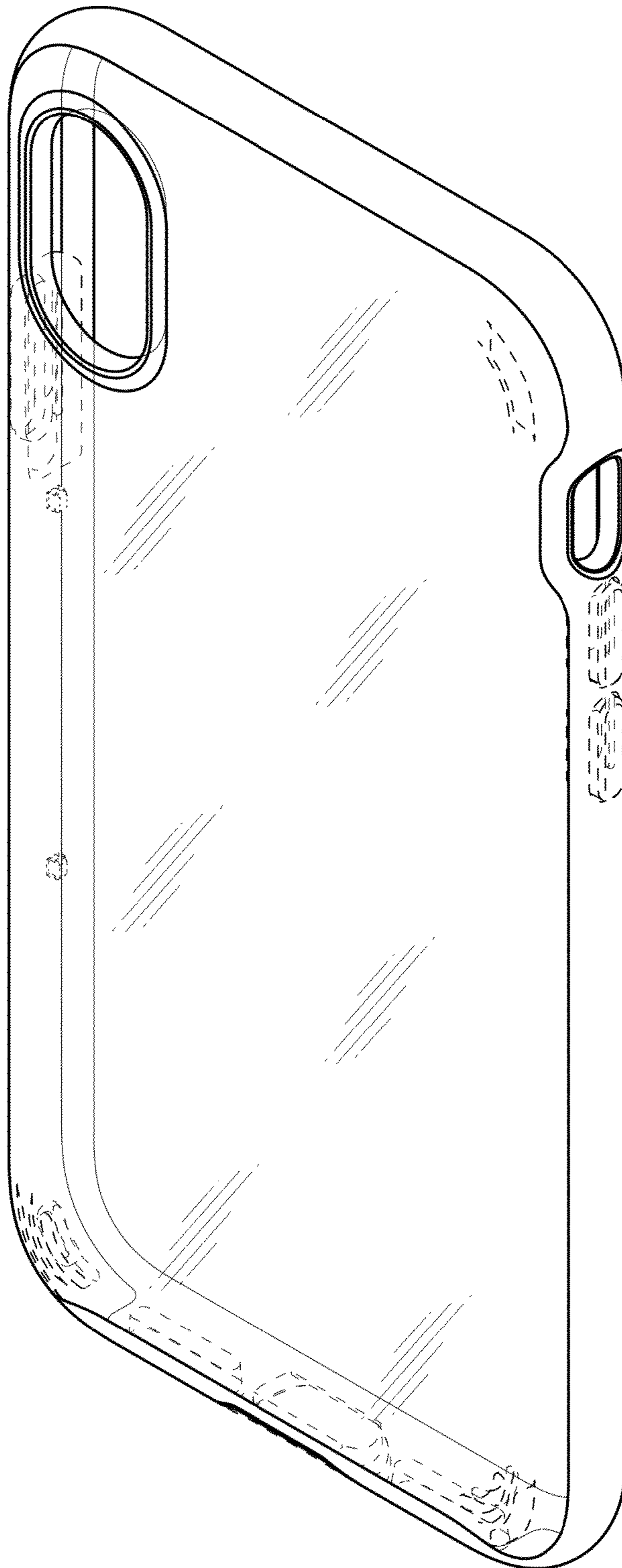

FIG. 3

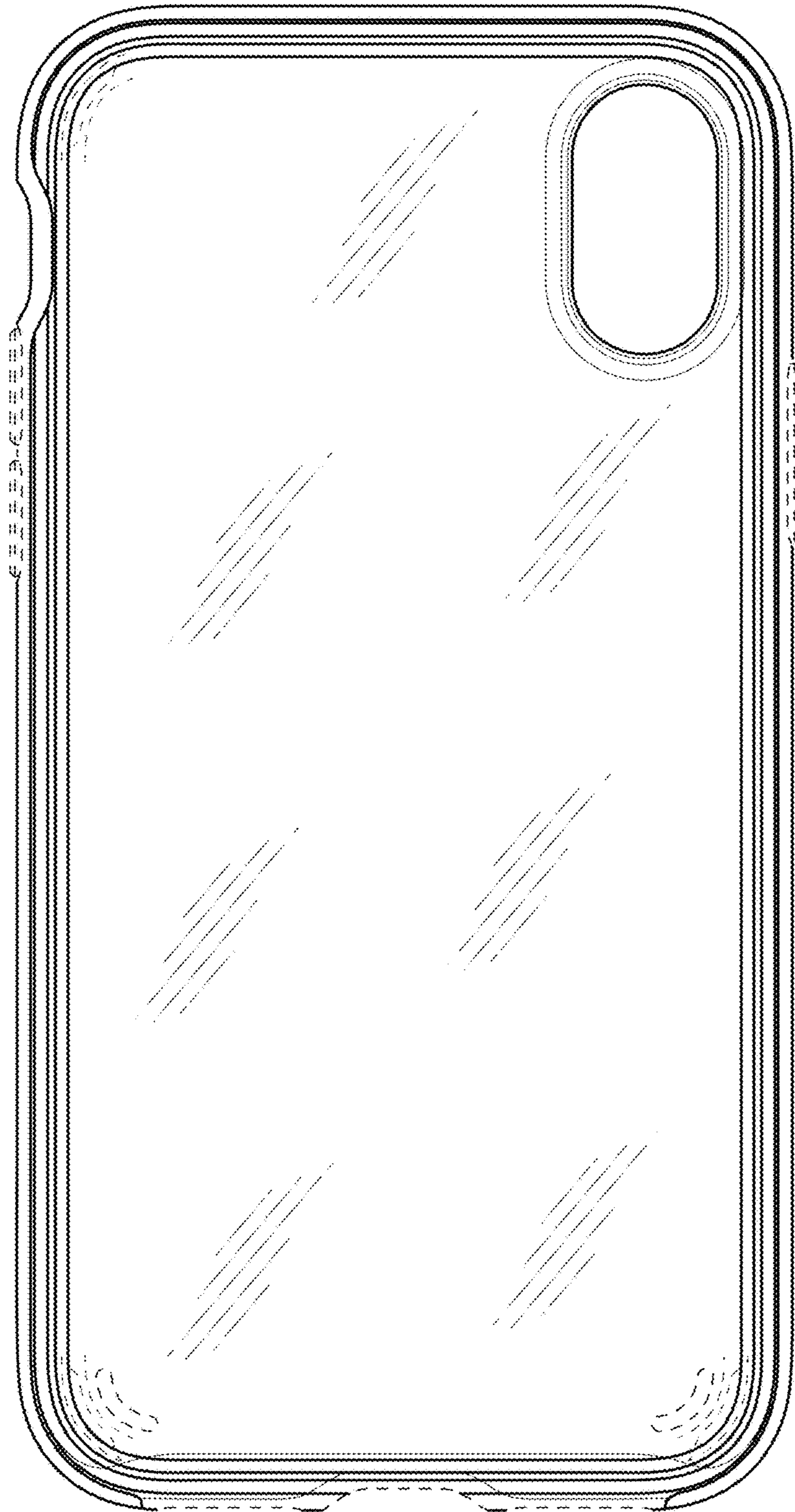

FIG. 4

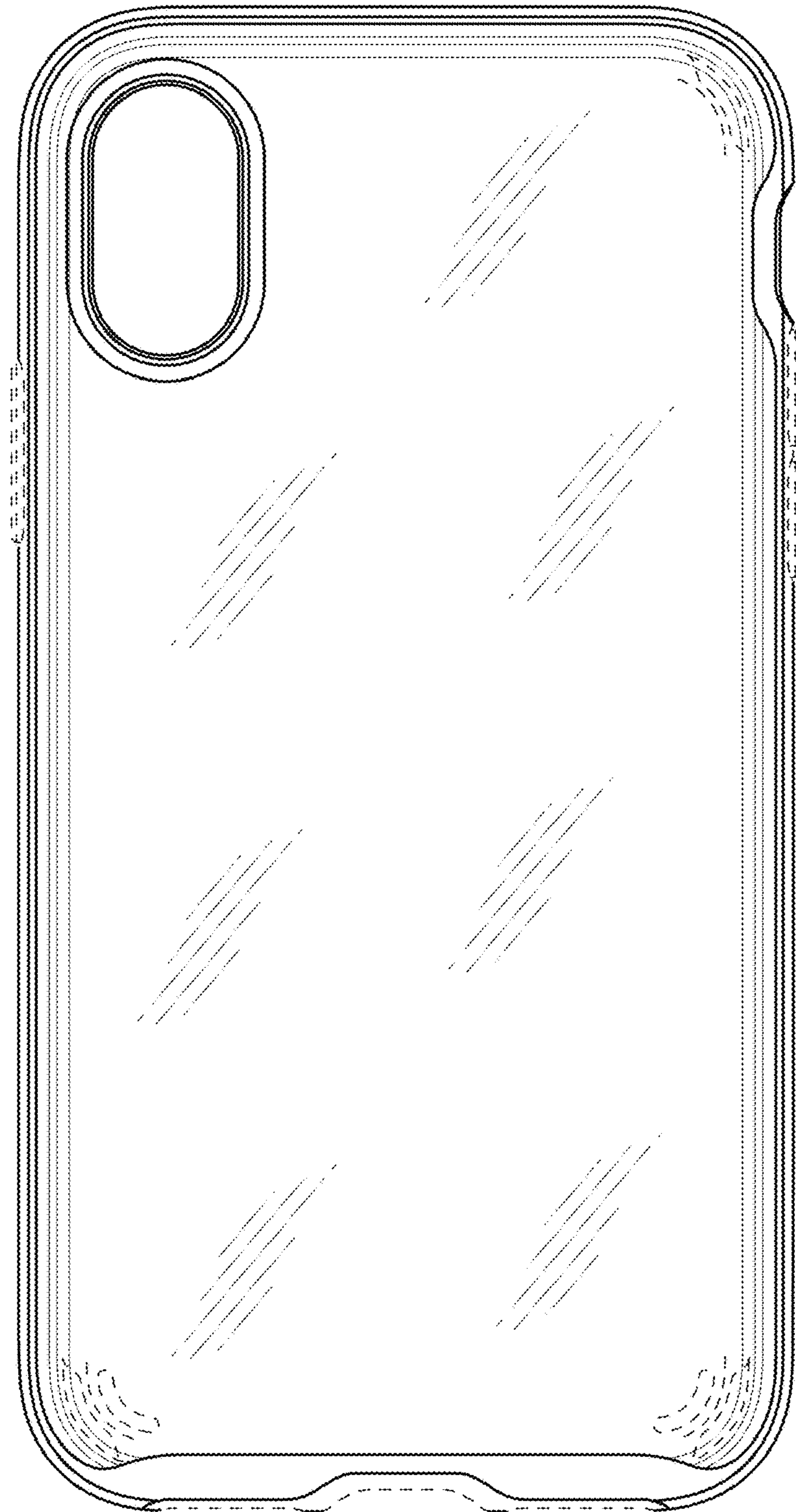

FIG. 5

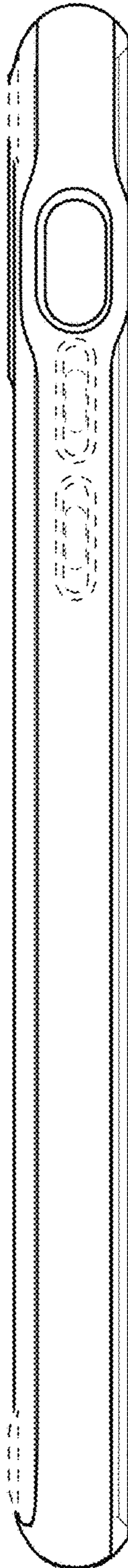

FIG. 6

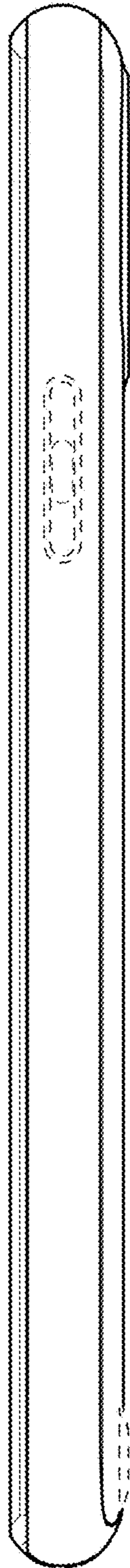

FIG. 7

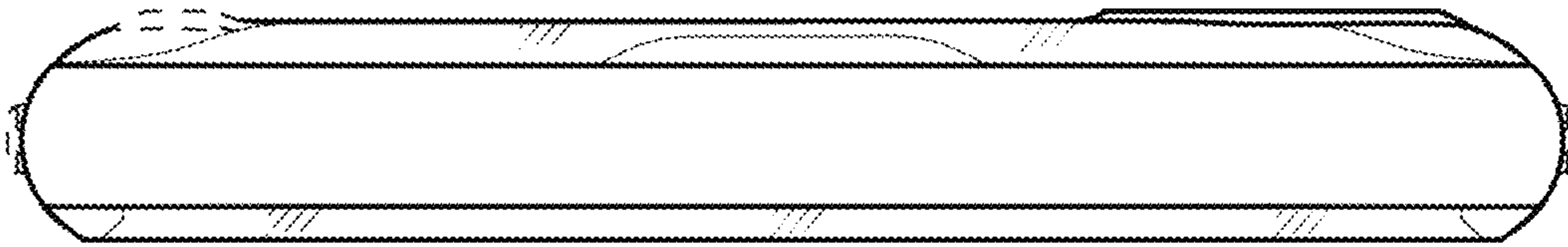

FIG. 8

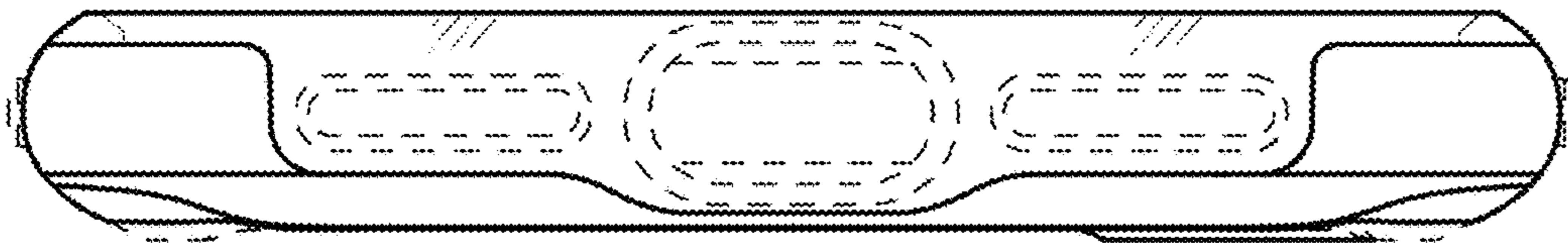

FIG. 9

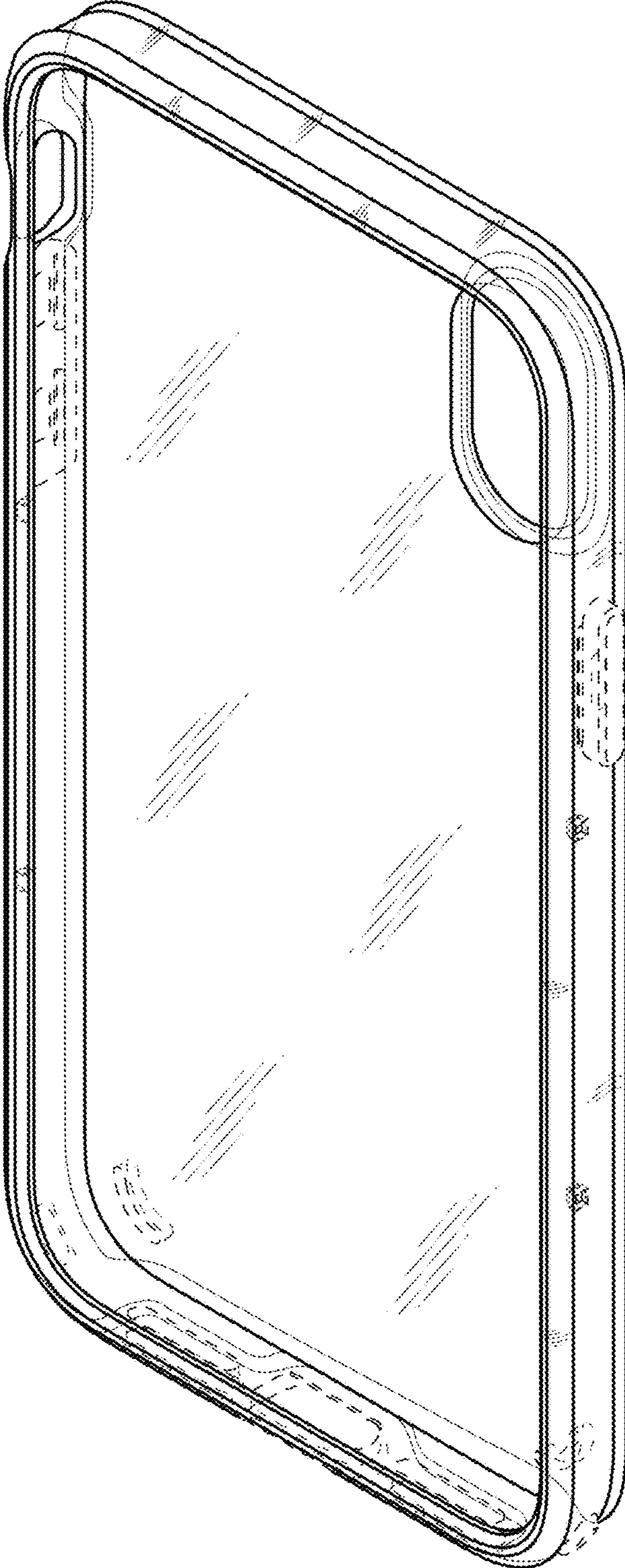

FIG. 10

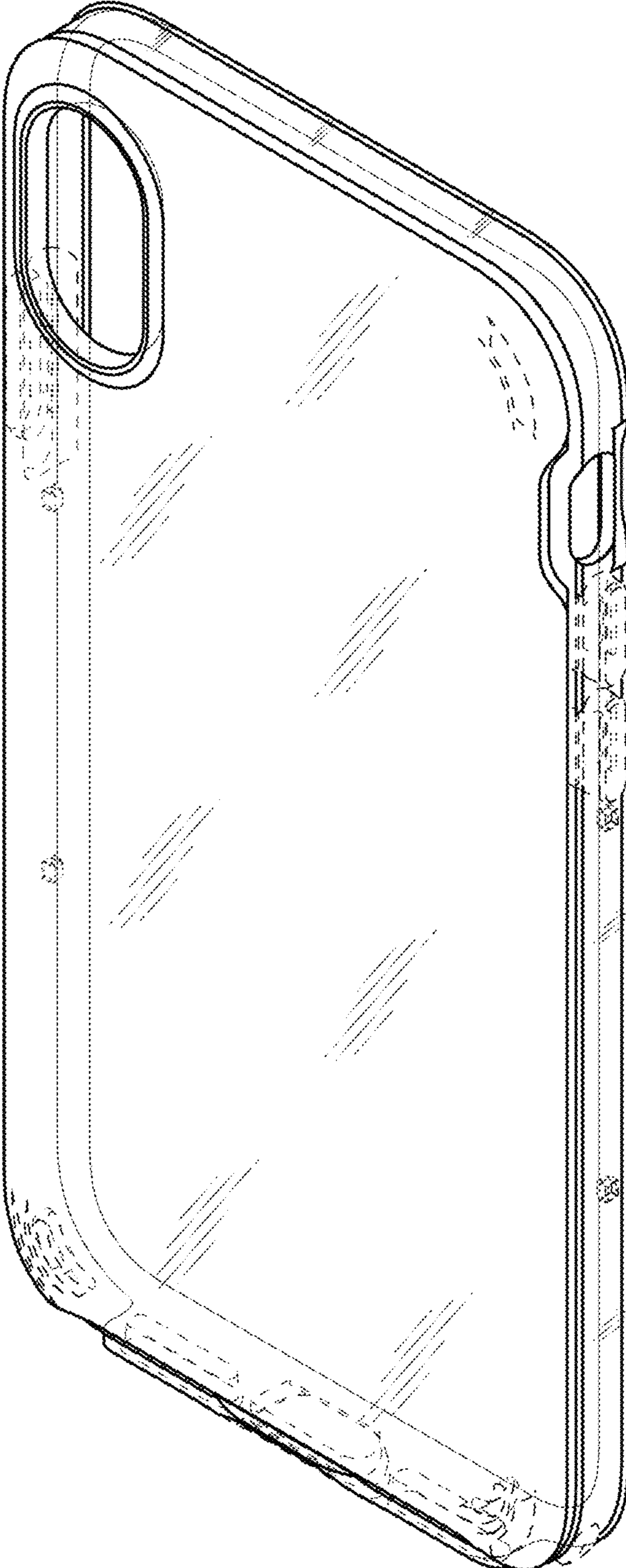

FIG. 11

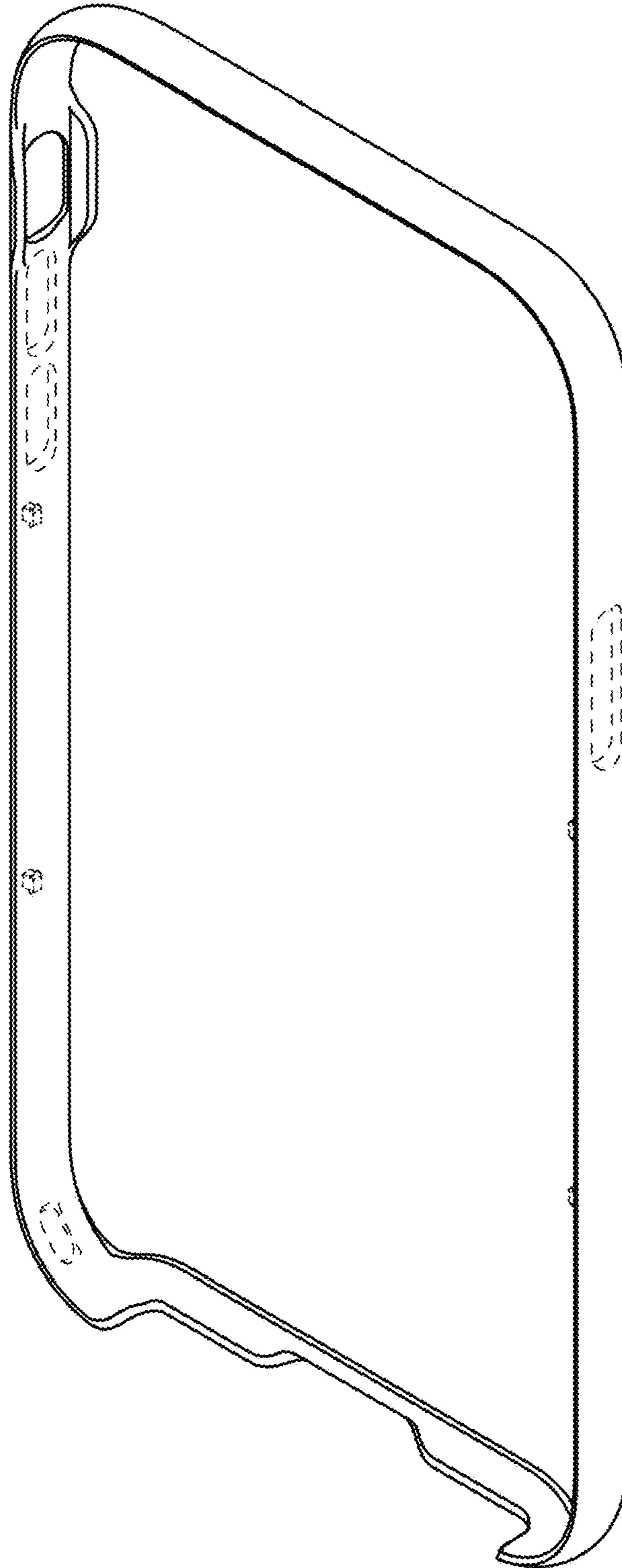

FIG. 12

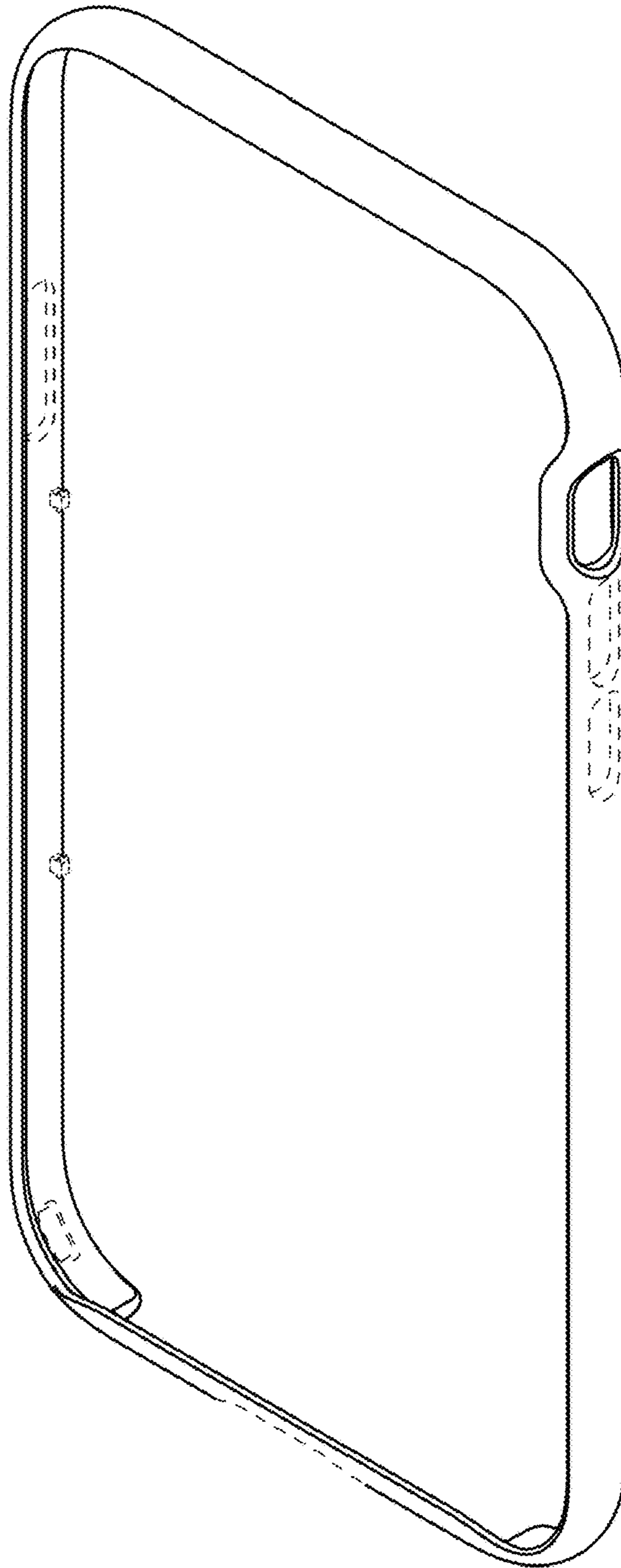

FIG. 13

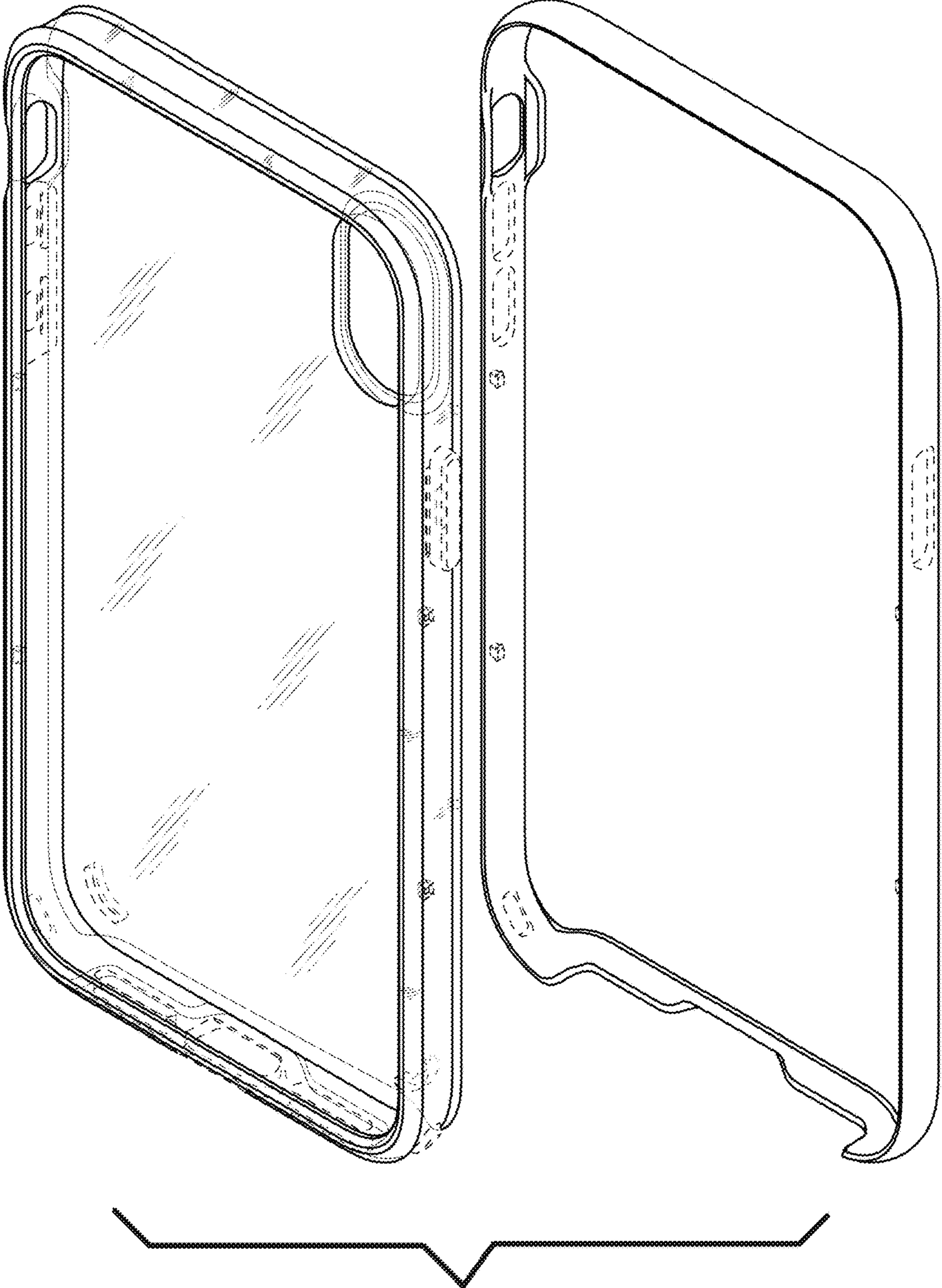

FIG. 14

