



US00D856955S

(12) **United States Design Patent** (10) **Patent No.:** **US D856,955 S**
Seo (45) **Date of Patent:** **** Aug. 20, 2019**

(54) **MOBILE PHONE**

(71) Applicant: **Samsung Electronics Co., Ltd.**,
Suwon-si (KR)

(72) Inventor: **Jaehun Seo**, Suwon-si (KR)

(73) Assignee: **SAMSUNG ELECTRONICS CO., LTD.**,
Suwon-si (KR)

(**) Term: **15 Years**

(21) Appl. No.: **29/591,545**

(22) Filed: **Jan. 20, 2017**

(30) **Foreign Application Priority Data**

Nov. 4, 2016 (KR) 30-2016-0053086

(51) **LOC (12) Cl.** **14-03**

(52) **U.S. Cl.**
USPC **D14/138 G**

(58) **Field of Classification Search**
USPC D14/138 AA, 138 G, 248, 250, 341
(Continued)

(56) **References Cited**

U.S. PATENT DOCUMENTS

D710,342 S * 8/2014 Fujimura D14/248
D731,481 S * 6/2015 Akana D14/341
(Continued)

FOREIGN PATENT DOCUMENTS

KR 30-0698312 6/2013
KR 30-0725377 1/2014
(Continued)

OTHER PUBLICATIONS

This May Be How Samsung Envisions the Ultimate Galaxy S
Flagship, Dominik Bosnjak, Jul. 8, 2018, [online], [site visited Sep.

10, 2018]. Retrieved from url:https://www.androidheadlines.com/2018/07/this-may-be-how-samsung-envisions-the-ultimate-galaxy-s-flagship.html (Year: 2018).*

(Continued)

Primary Examiner — Jeffrey D Asch

Assistant Examiner — Tracey J Bell

(74) *Attorney, Agent, or Firm* — McAndrews Held & Malloy, Ltd.

(57) **CLAIM**

The ornamental design for a mobile phone, as shown and described.

DESCRIPTION

FIG. 1 is a front perspective view of a mobile phone showing my new design according to a first embodiment;
FIG. 2 is a front elevation view thereof;
FIG. 3 is a rear elevation view thereof;
FIG. 4 is a left side elevation view thereof;
FIG. 5 is a right side elevation view thereof;
FIG. 6 is a top plan view thereof;
FIG. 7 is a bottom plan view thereof;
FIG. 8 is a rear perspective view thereof;
FIG. 9 is a front perspective view of a mobile phone showing my new design according to the first embodiment shown in FIGS. 1-8 albeit with alternate environment;
FIG. 10 is a front elevation view thereof;
FIG. 11 is a rear elevation view thereof;
FIG. 12 is a left side elevation view thereof;
FIG. 13 is a right side elevation view thereof;
FIG. 14 is a top plan view thereof;
FIG. 15 is a bottom plan view thereof;
FIG. 16 is a rear perspective view thereof;
FIG. 17 is a front perspective view of a mobile phone showing my new design according to a second embodiment;
FIG. 18 is a front elevation view thereof;
FIG. 19 is a rear elevation view thereof;
FIG. 20 is a left side elevation view thereof;
FIG. 21 is a right side elevation view thereof;
FIG. 22 is a top plan view thereof;
FIG. 23 is a bottom plan view thereof;
FIG. 24 is a rear perspective view thereof;

(Continued)

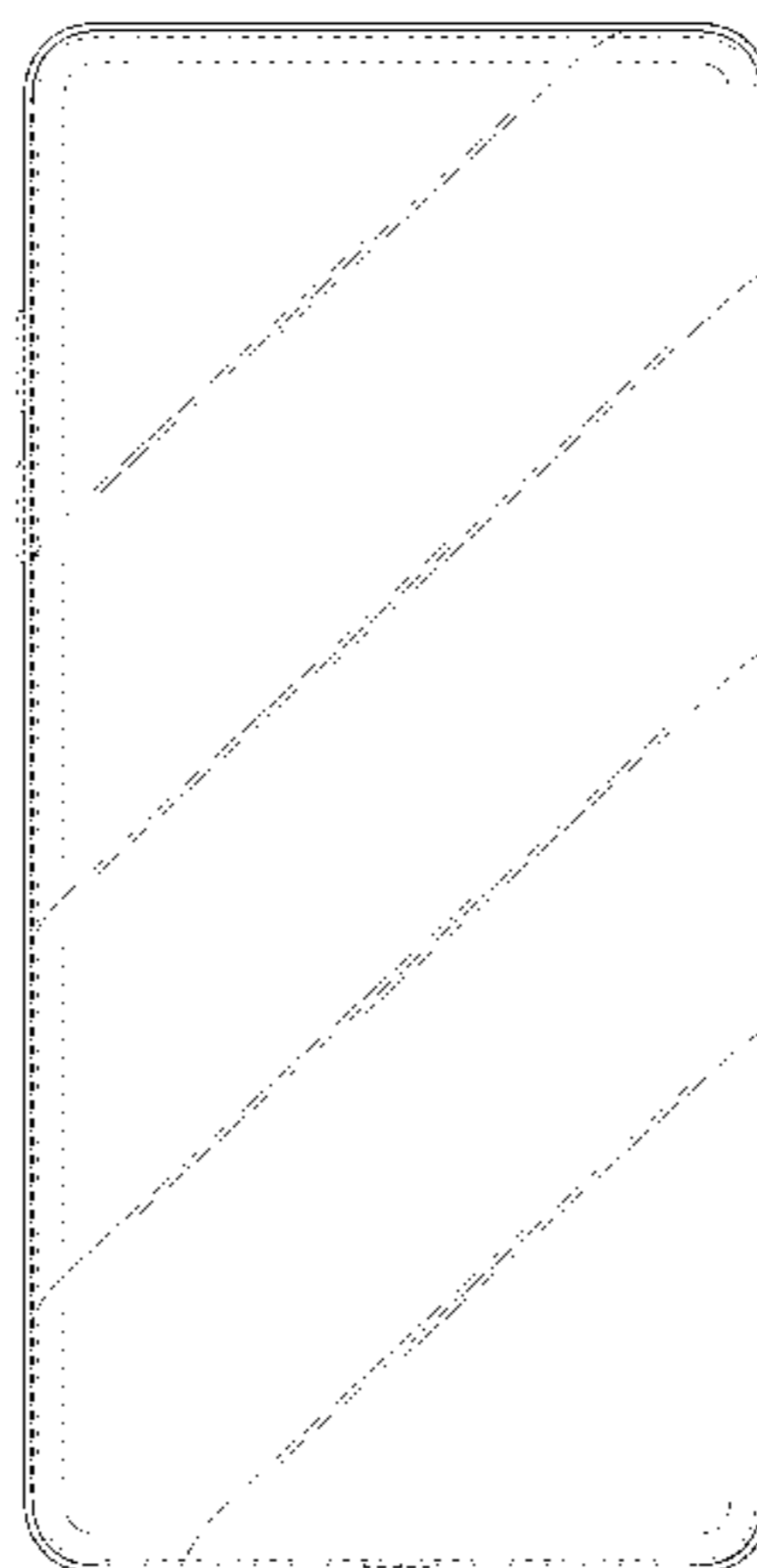

FIG. 25 is a front perspective view of a mobile phone showing my new design according to the second embodiment shown in FIGS. 17-24 albeit with alternate environment;

FIG. 26 is a front elevation view thereof;

FIG. 27 is a rear elevation view thereof;

FIG. 28 is a left side elevation view thereof;

FIG. 29 is a right side elevation view thereof;

FIG. 30 is a top plan view thereof;

FIG. 31 is a bottom plan view thereof; and,

FIG. 32 is a rear perspective view thereof.

The broken lines shown in the figures that are immediately adjacent to the shaded areas and define unshaded regions represent the bounds of the claim. All other broken lines, including the features within broken line boundaries and the display are directed to environment. The broken lines form no part of the claimed design.

1 Claim, 28 Drawing Sheets

(58) Field of Classification Search

CPC G06F 1/1626; G06F 1/1652; H04M 1/027; H04M 1/0202; H04M 1/0279; H04M 1/0235; H04M 1/0237; H04M 1/0239; H04M 1/0266; H04M 1/0268; H04M 1/0295

See application file for complete search history.

(56) References Cited

U.S. PATENT DOCUMENTS

D783,602	S	*	4/2017	Akana	D14/341
D788,735	S	*	6/2017	Daniel	D14/138 G
D791,732	S	*	7/2017	Xu	D14/138 G
D795,213	S	*	8/2017	Kim	D14/138 G
D795,827	S	*	8/2017	Seo	D14/138 G
D795,829	S	*	8/2017	Seo	D14/138 G
D796,469	S	*	9/2017	Jin	D14/138 G
D797,071	S	*	9/2017	Seo	D14/138 G
D800,683	S	*	10/2017	Park	D14/138 G
D800,716	S	*	10/2017	Akana	D14/341
D802,553	S	*	11/2017	Berneth	D14/138 G
D803,209	S	*	11/2017	Akana	D14/341
D814,456	S	*	4/2018	Zhang	D14/341
D815,612	S	*	4/2018	Shin	D14/138 G
D815,634	S	*	4/2018	Akana	D14/341
D816,055	S	*	4/2018	Song	D14/138 G
D817,324	S	*	5/2018	Akana	D14/341
D824,870	S	*	8/2018	Shin	D14/138 G
D824,871	S	*	8/2018	Shin	D14/138 G
D825,516	S	*	8/2018	Li	D14/138 G
D825,556	S	*	8/2018	Akana	D14/341

D826,202	S	*	8/2018	Park	D14/138 G
D826,888	S	*	8/2018	Shin	D14/138 G
10,069,952	B2	*	9/2018	De Wind	H04M 1/026
2018/0164850	A1	*	6/2018	Sim	G06F 1/1626
2018/0183912	A1	*	6/2018	Lim	G06F 1/1626
2018/0183913	A1	*	6/2018	Kwak	H04M 1/0268
2018/0244565	A1	*	8/2018	Paulson	C03C 17/225

FOREIGN PATENT DOCUMENTS

KR	30-0725379	3/2014
KR	30-0752311	7/2014
KR	30-0813778	9/2015
KR	30-0825060	11/2015
KR	30-0840029	2/2016
KR	30-0843736	3/2016

OTHER PUBLICATIONS

Google Pixel Ultra Rendered, Maybe Coming This Year, Maybe Not, Aug. 14, 2018, Kelvin, [online], [site visited Sep. 10, 2018]. Retrieved from url:<https://www.concept-phones.com/google/google-pixel-ultra-rendered-maybe-coming-this-year-maybe-not/> (Year: 2018).*

Xiaomi Mi Mix 3 Rendered as the iPhone X Killer, Apr. 4, 2018, Kelvin, [online], [site visited Sep. 10, 2018]. Retrieved from url:<https://www.concept-phones.com/xiaomi/xiaomi-mi-mix-3-rendered-iphone-killer/> (Year: 2018).*

Xiaomi Mi Mix 2, Sep. 2017, [online], [site visited Sep. 8, 2018]. Retrieved from url:https://www.gsmarena.com/xiaomi_mi_mix_2-pictures-8529.php (Year: 2017).*

Nguyen, Lanh, "Alcatel Idol 4 and Idol 4S hands on", published Feb. 20, 2016 at androidauthority.com, <http://www.androidauthority.com/alcatel-idol-4-and-idol-4s-hands-on-674583/> (Last accessed Jan. 11, 2017).

Unknown, "vivo Xplay5 Elite pictures", published at gsmarena.com, http://www.gsmarena.com/vivo_xplay5_elite-pictures-7970.php (Last accessed Jan. 11, 2017).

P., Daniel, "LG Class, the company's first metal-clad Android, gets unboxed and previewed", published Sep. 24 2015 at phonearena.com, http://www.phonearena.com/news/LG-Class-the-companys-first-metal-clad-Android-gets-unboxed-and-previewed_id74017 (Last accessed Jan. 11, 2017).

Hoffmann, Jan, "HTC Desire 626G and Desire 526G: Mittelklasse—Smartphones mit Dual-SIM vorgestellt", published Mar. 24, 2015 at giga.de, <http://www.giga.de/unternehmen/htc/news/htc-desire-62g-und-desire-526g-mittelklasse-smartphones-mit-dual-sim-vorgestellt/>.

Unknown, "Yota YotaPhone 2 Pictures", published at gsmarena.com, http://www.gsmarena.com/yota_yotaphone_2-pictures-6959.php (Last accessed Jan. 11, 2017).

Unknown, "Apple iPhone 6 Plus pictures", published at gsmarena.com, http://www.gsmarena.com/apple_iphone_6_plus-pictures-6665.php (Last accessed Jan. 11, 2017).

Unknown, Sony Xperia E3 Dual pictures, published at gsmarena.com, http://www.gsmarena.com/sony_xperia_e3_dual-pictures-6663.php (Last accessed Jan. 11, 2017).

* cited by examiner

FIG. 1

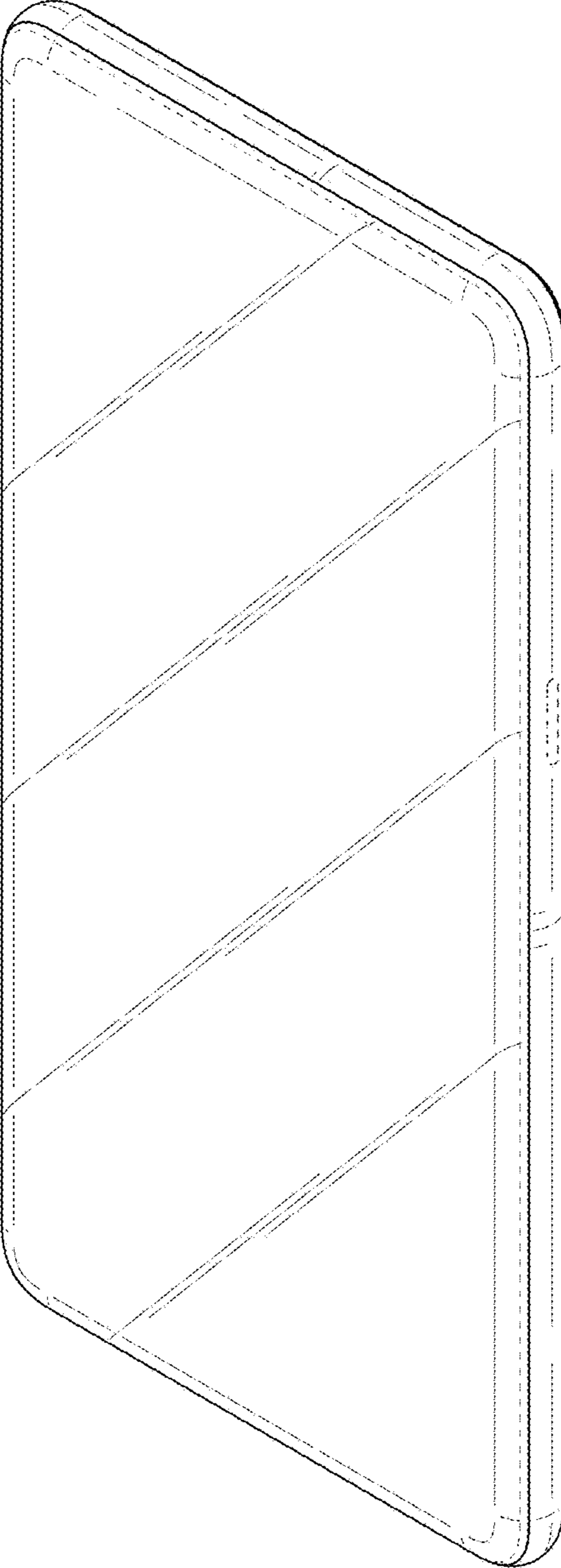

FIG. 2

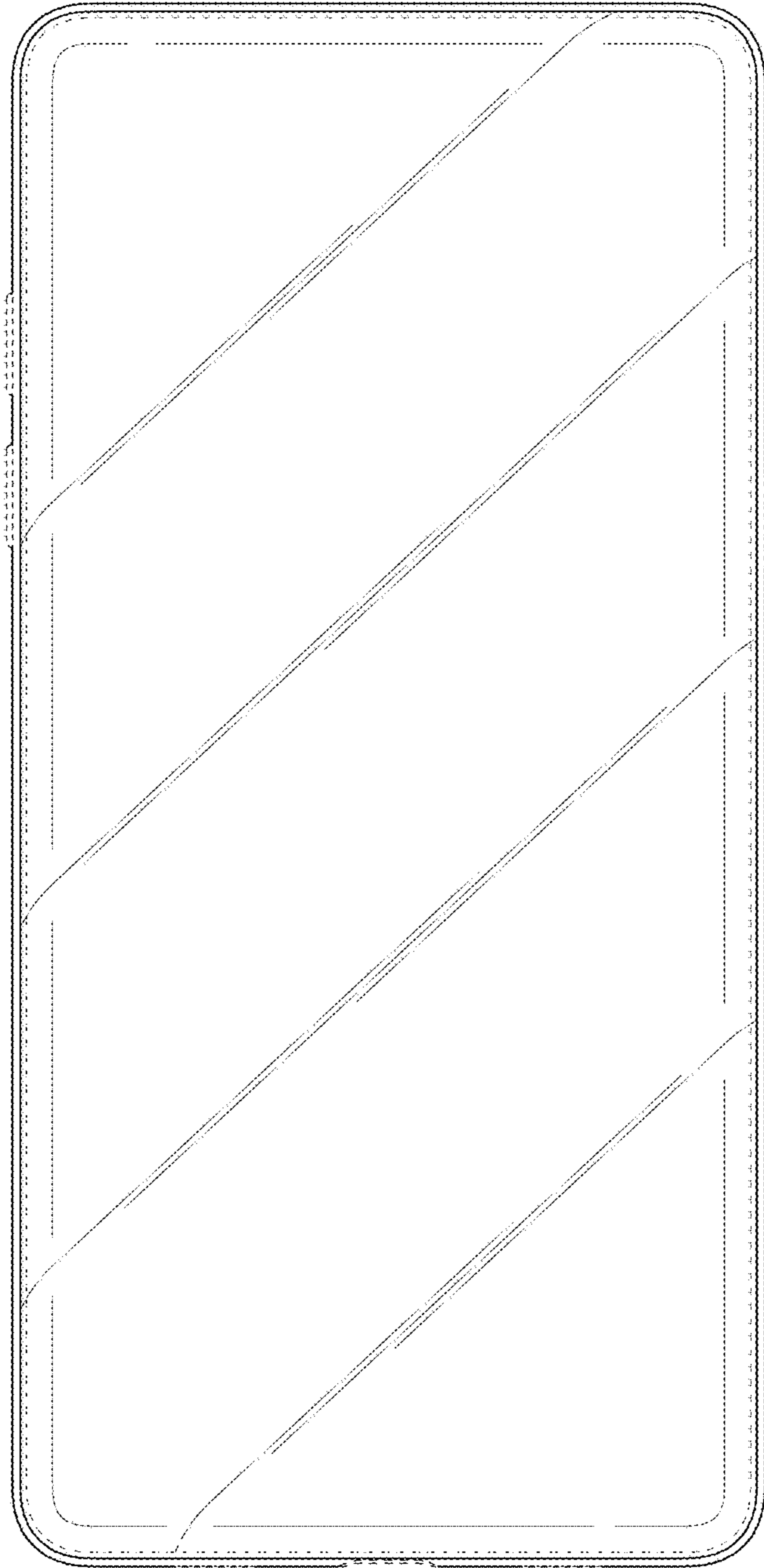

FIG. 3

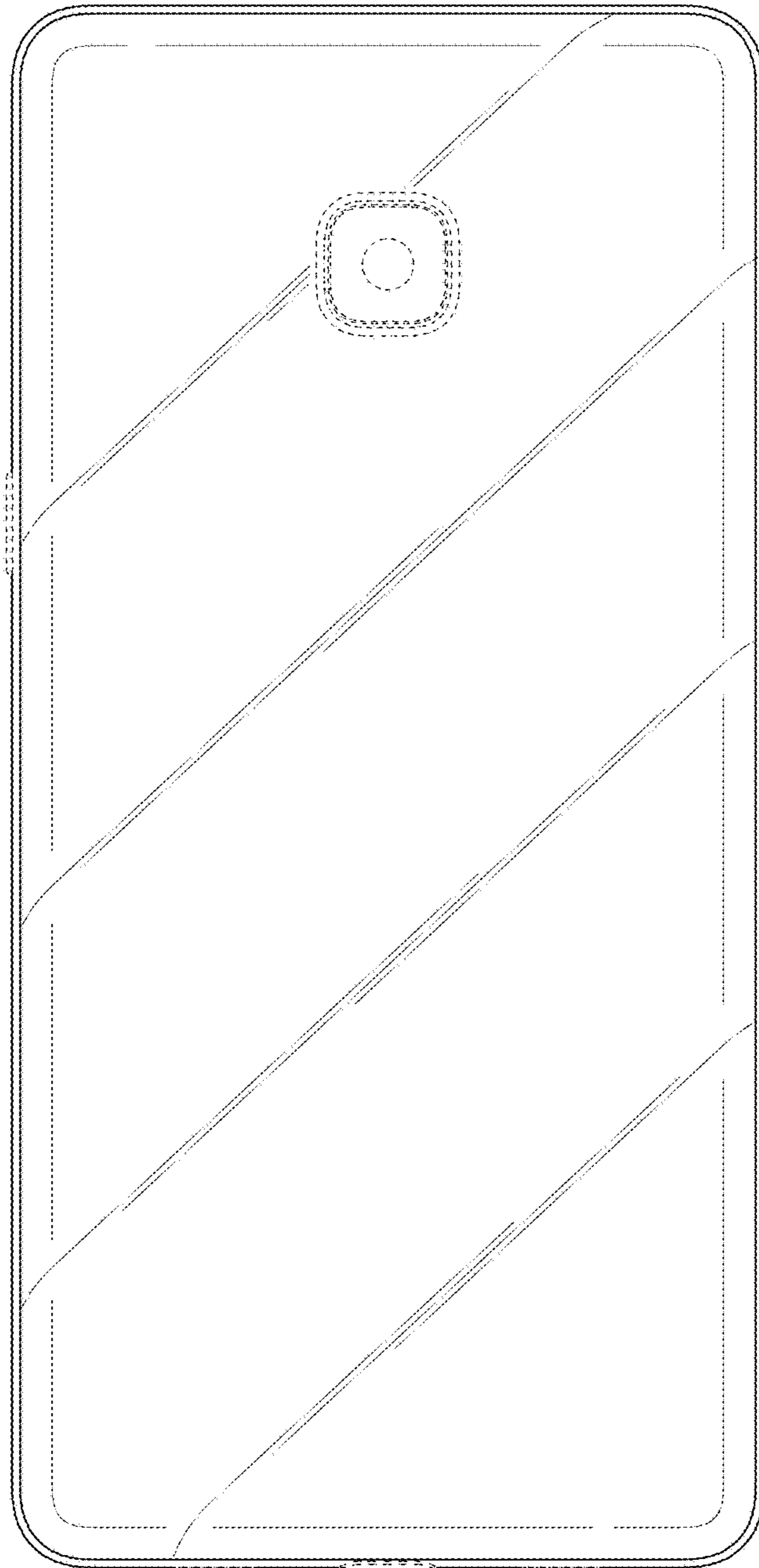

FIG. 4

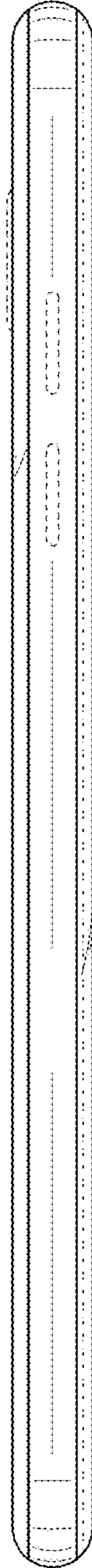

FIG. 5

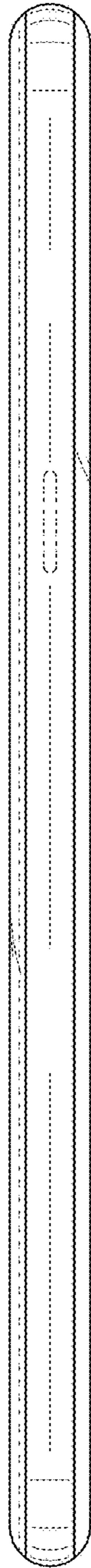

FIG. 6



FIG. 7

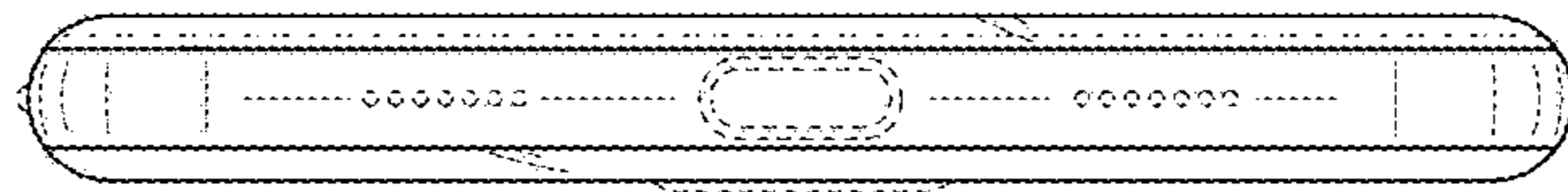

FIG. 8

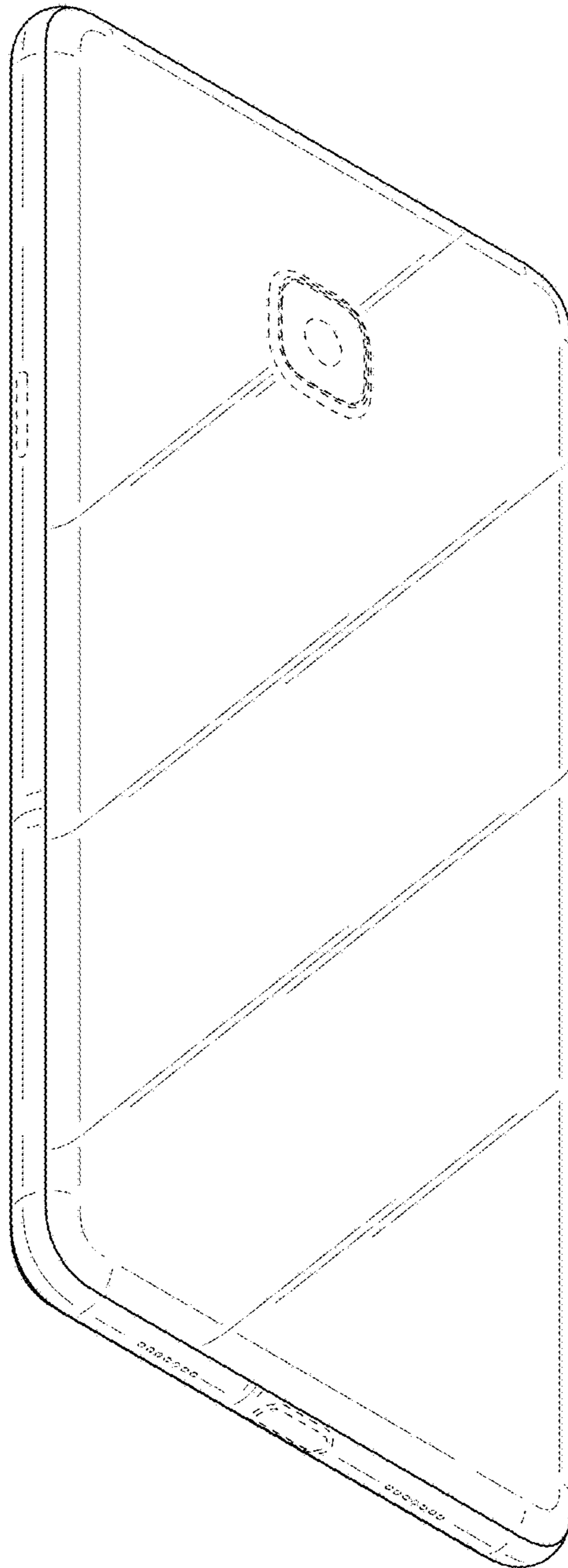

FIG. 9

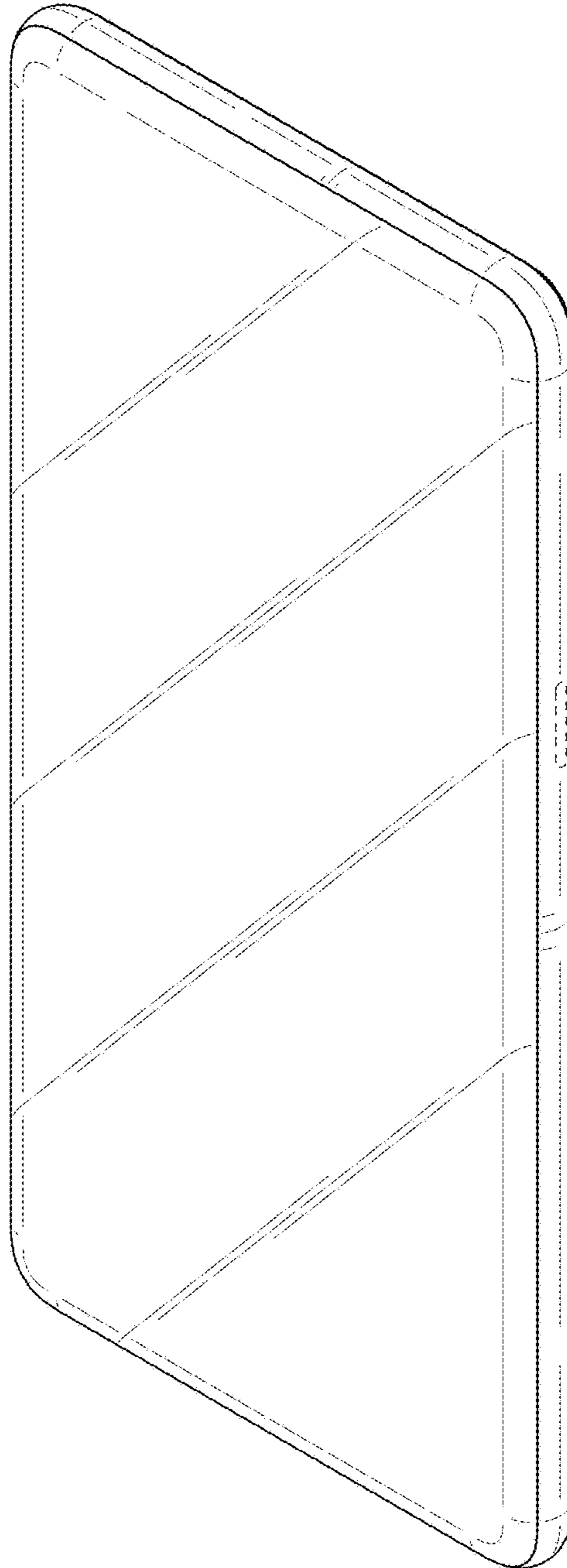

FIG. 10

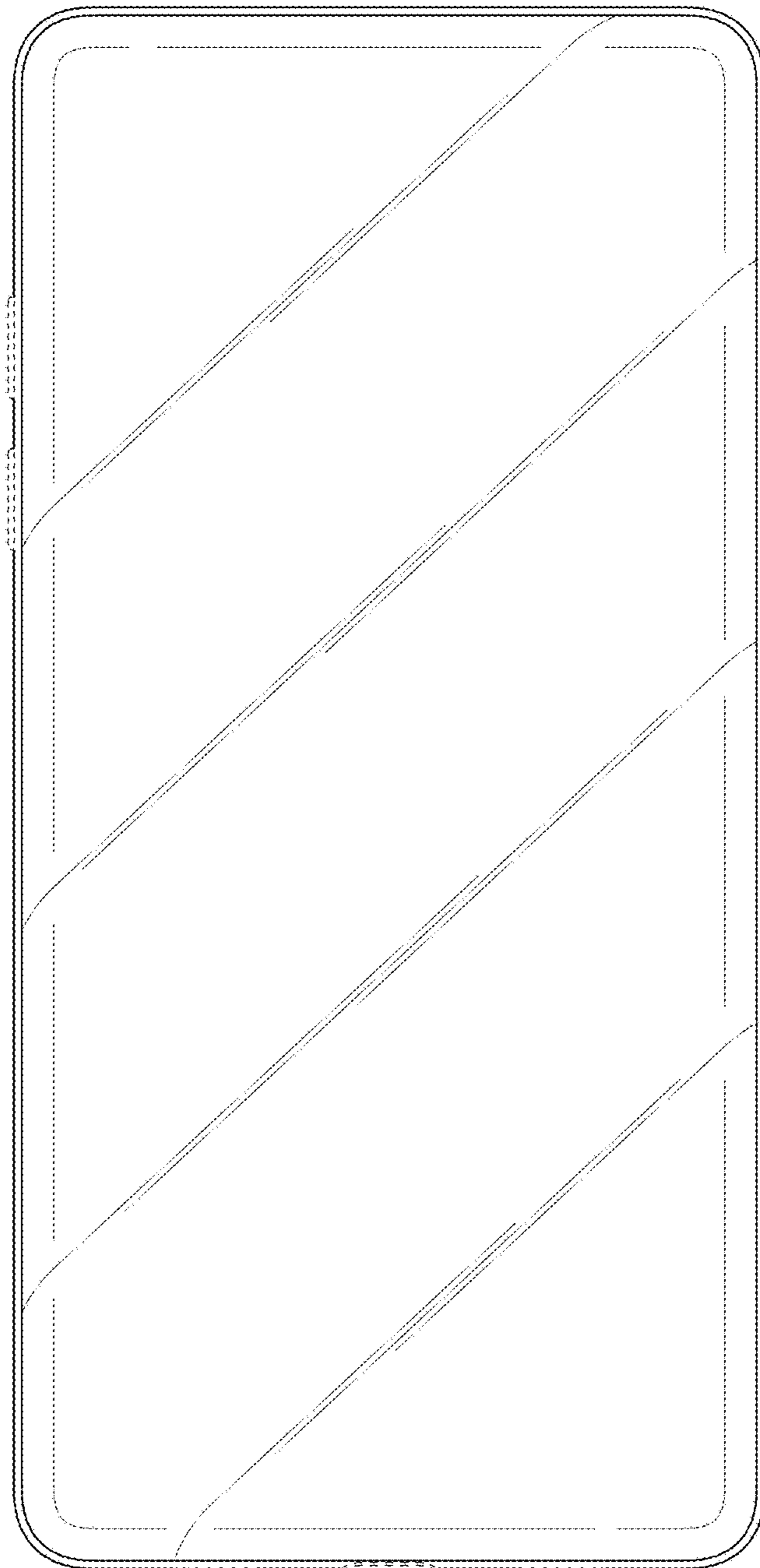

FIG. 11

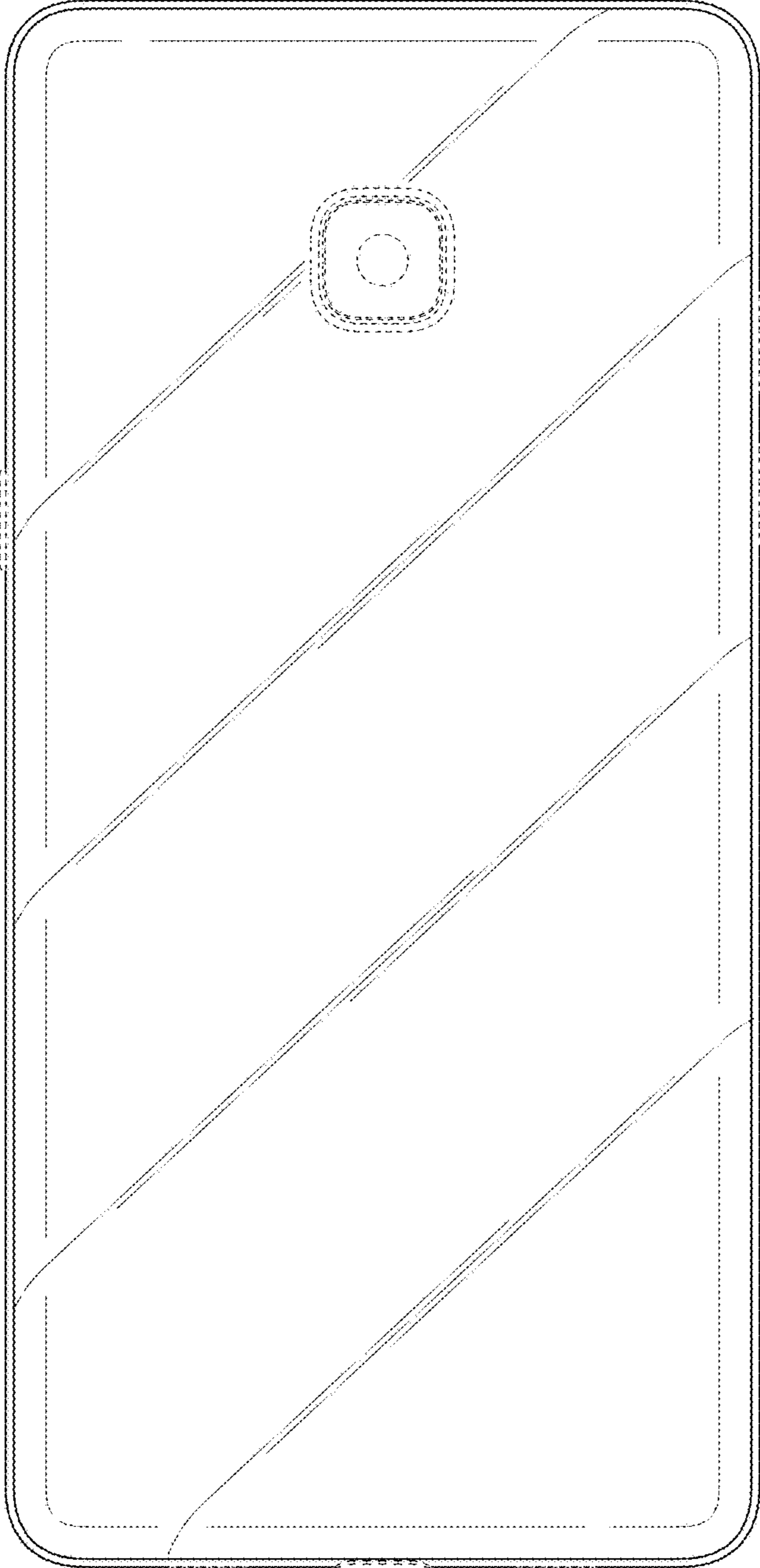

FIG. 12

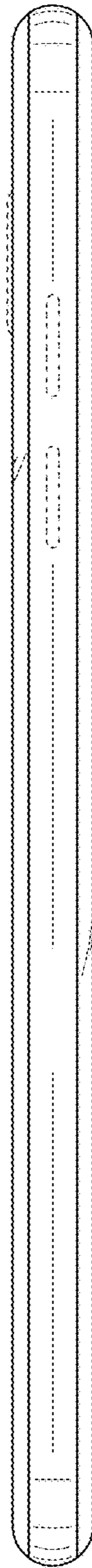

FIG. 13

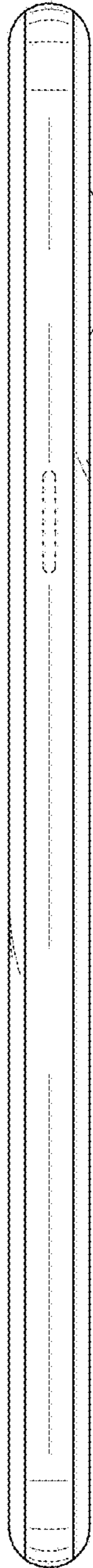

FIG. 14

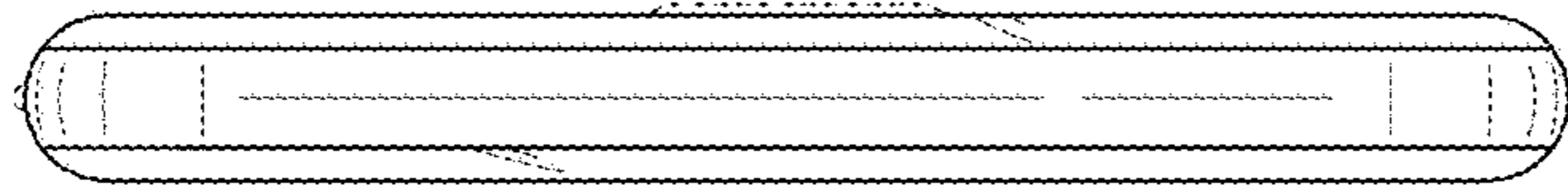

FIG. 15

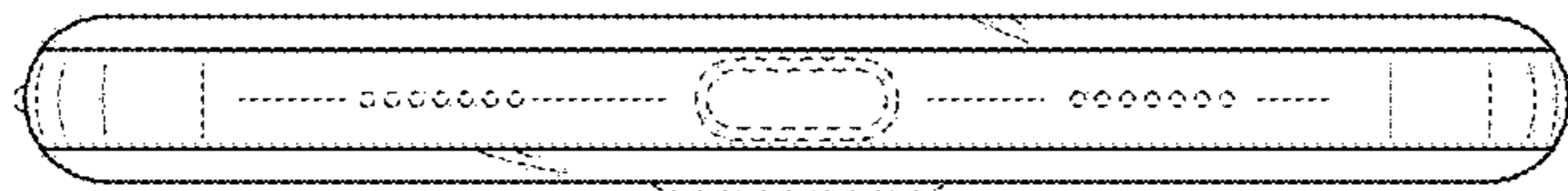

FIG. 16

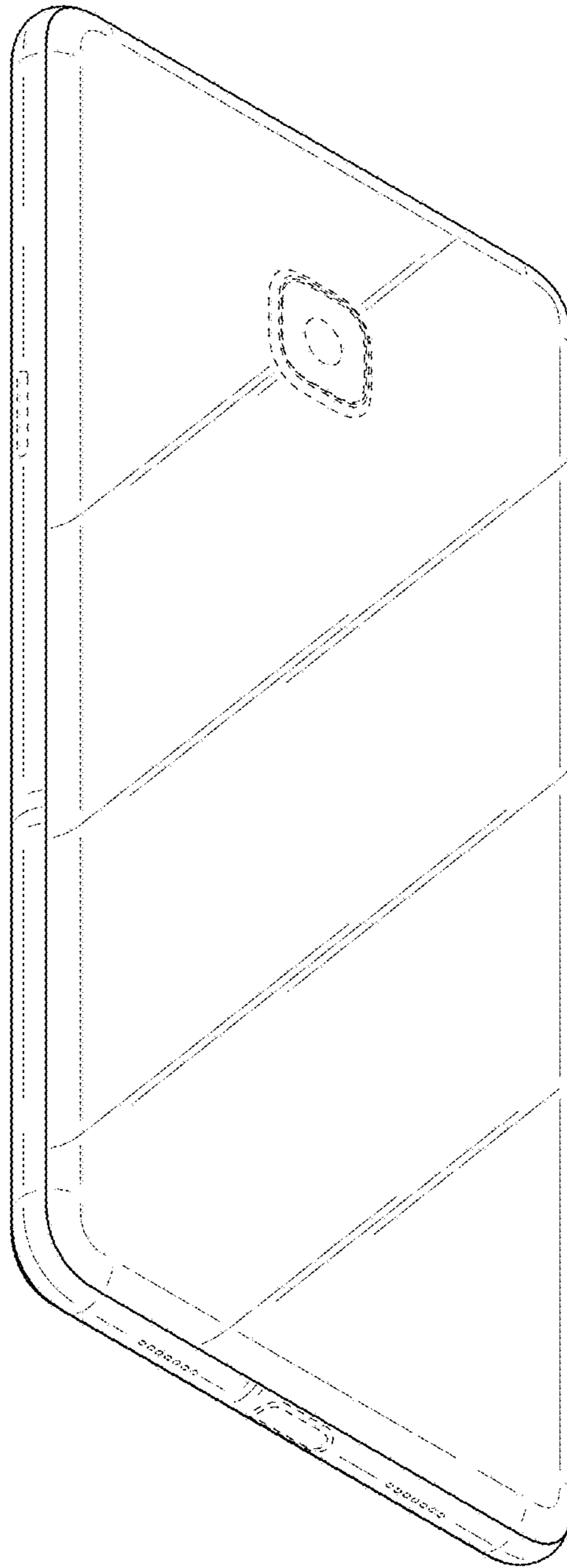

FIG. 17

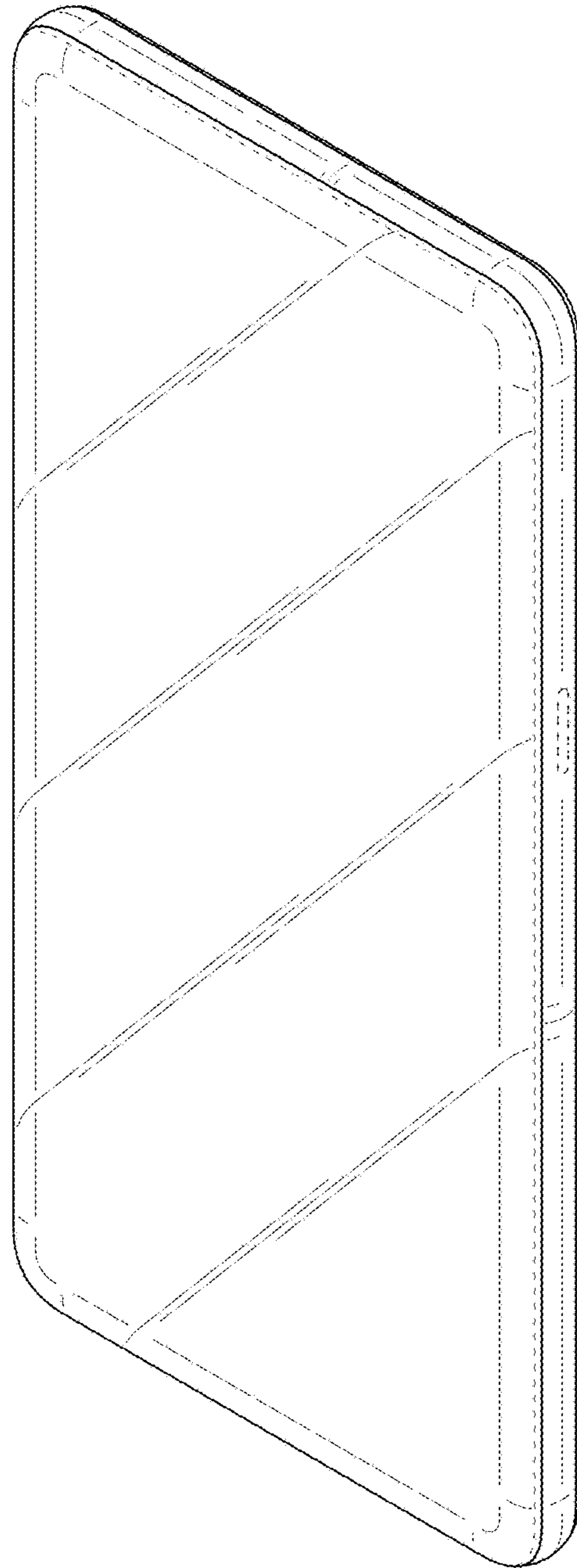

FIG. 18

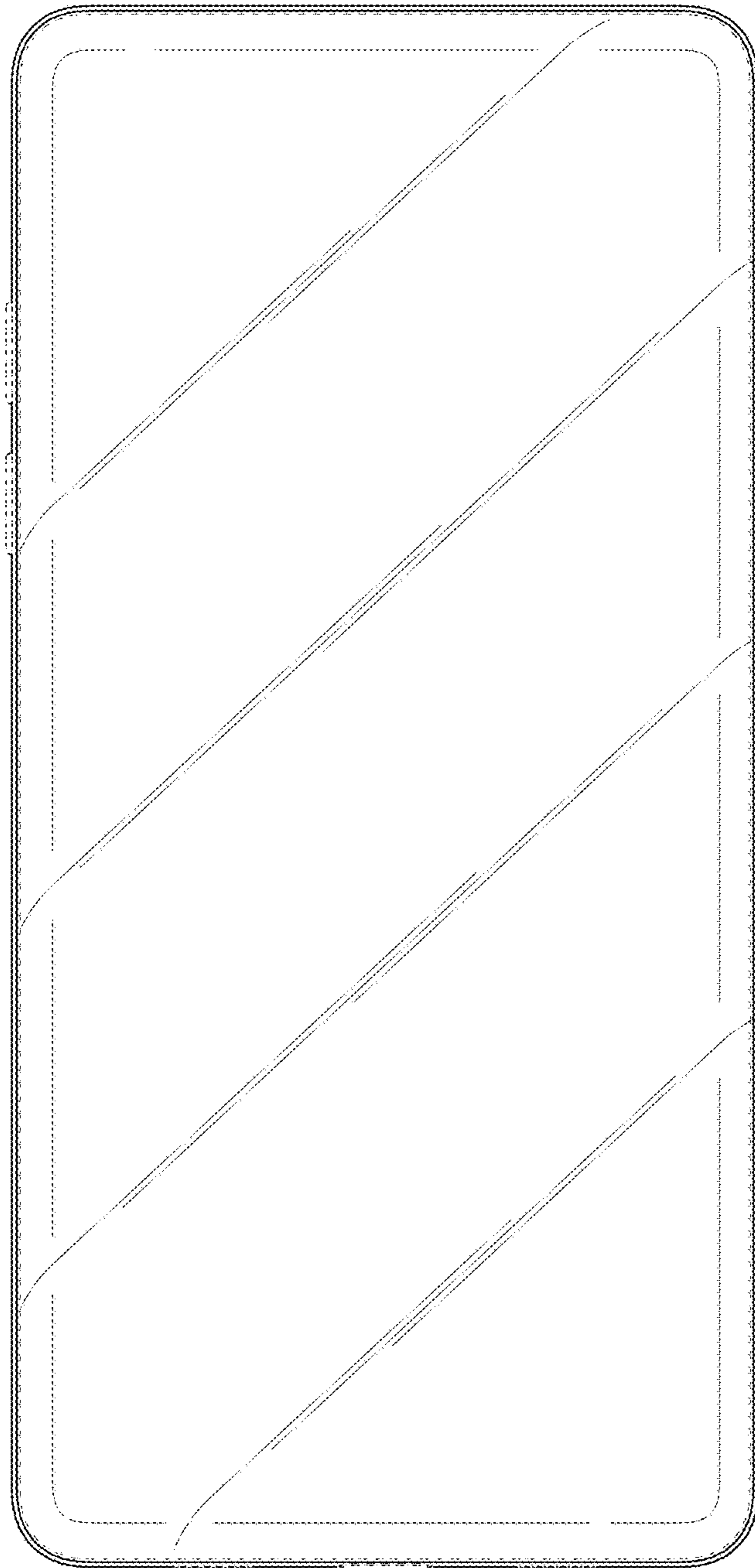

FIG. 19

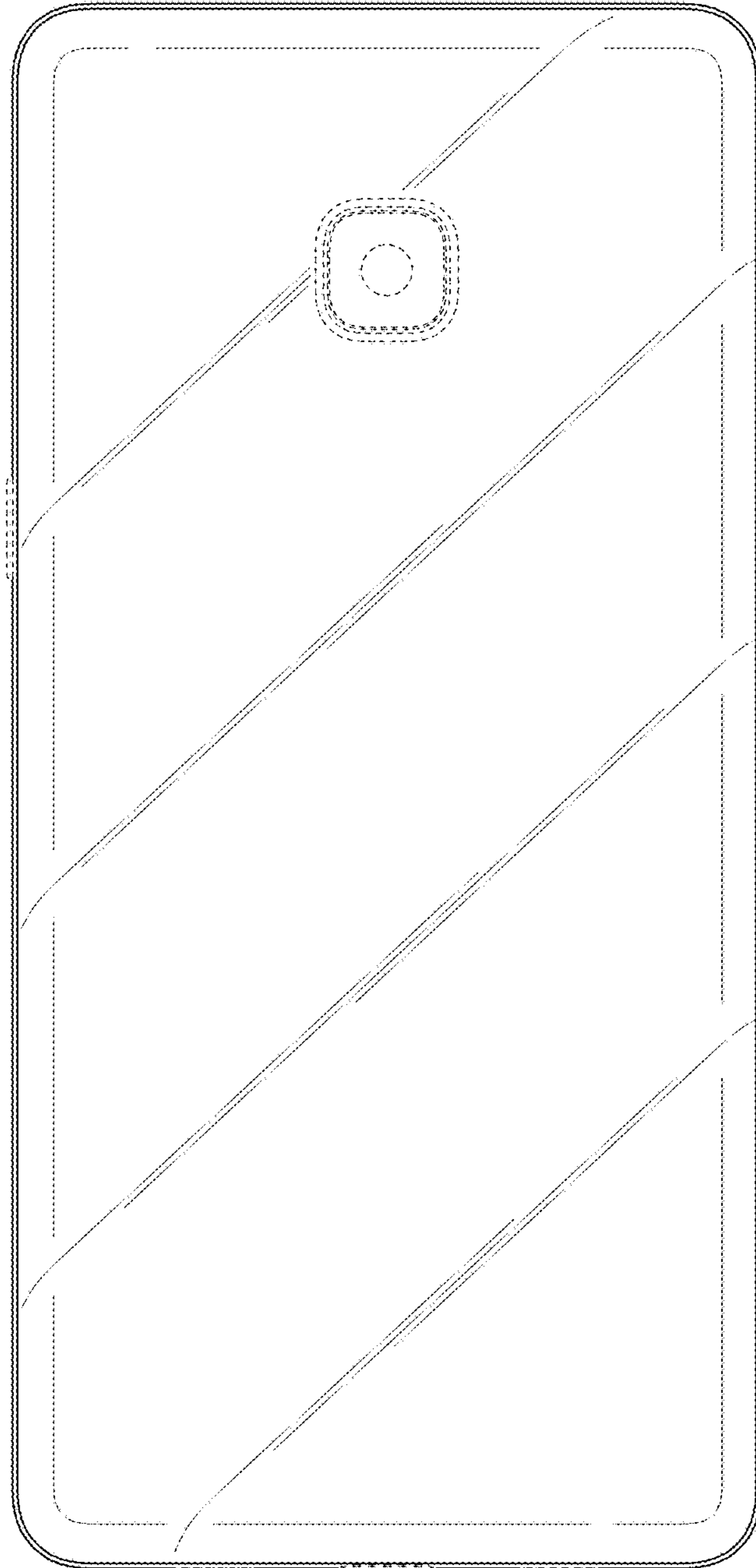

FIG. 20

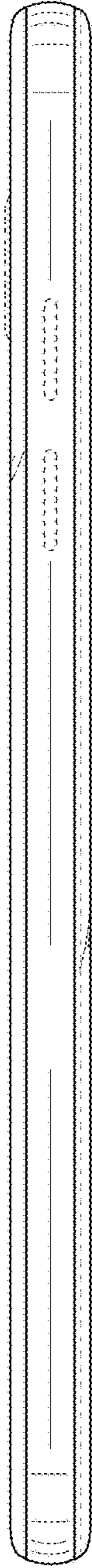

FIG. 21

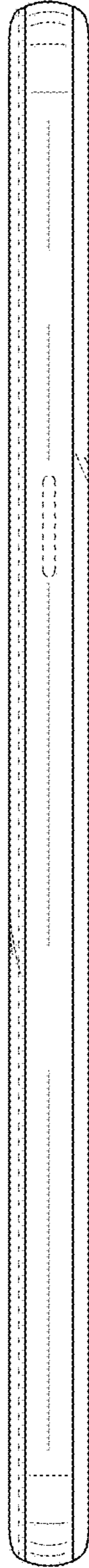

FIG. 22



FIG. 23

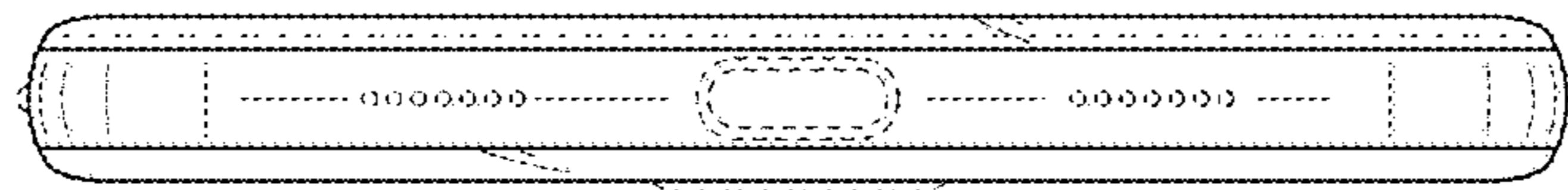

FIG. 24

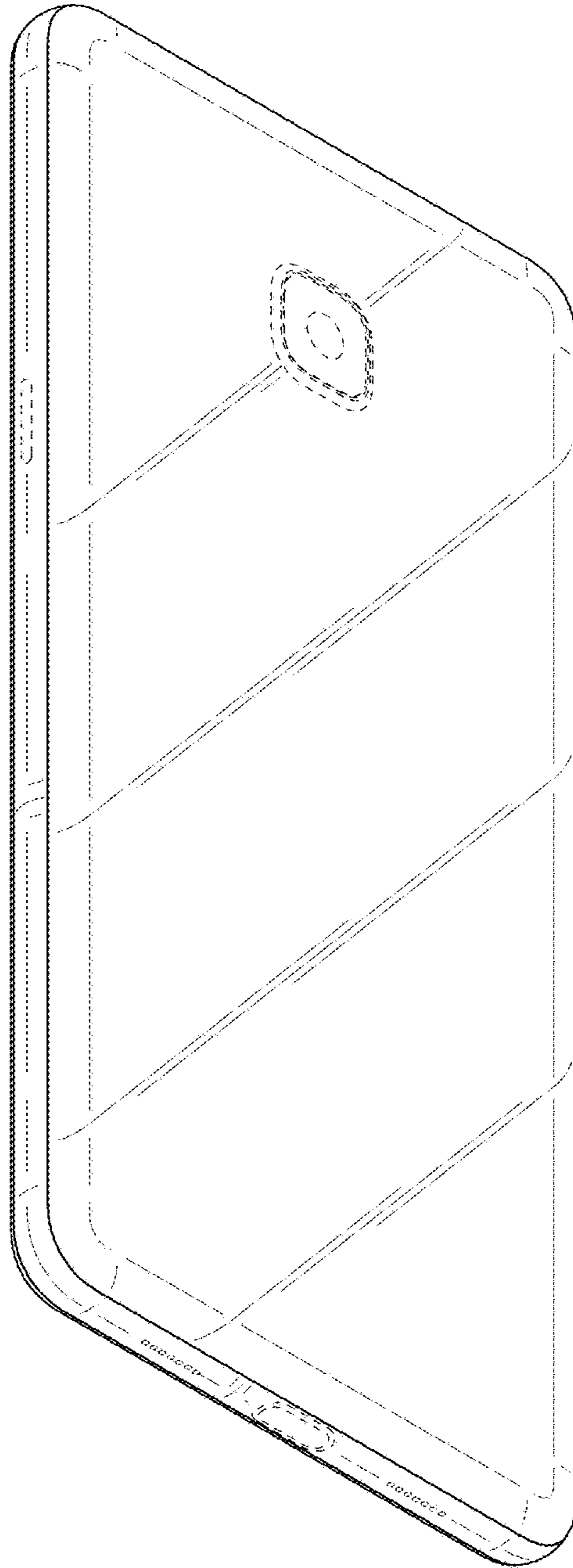

FIG. 25

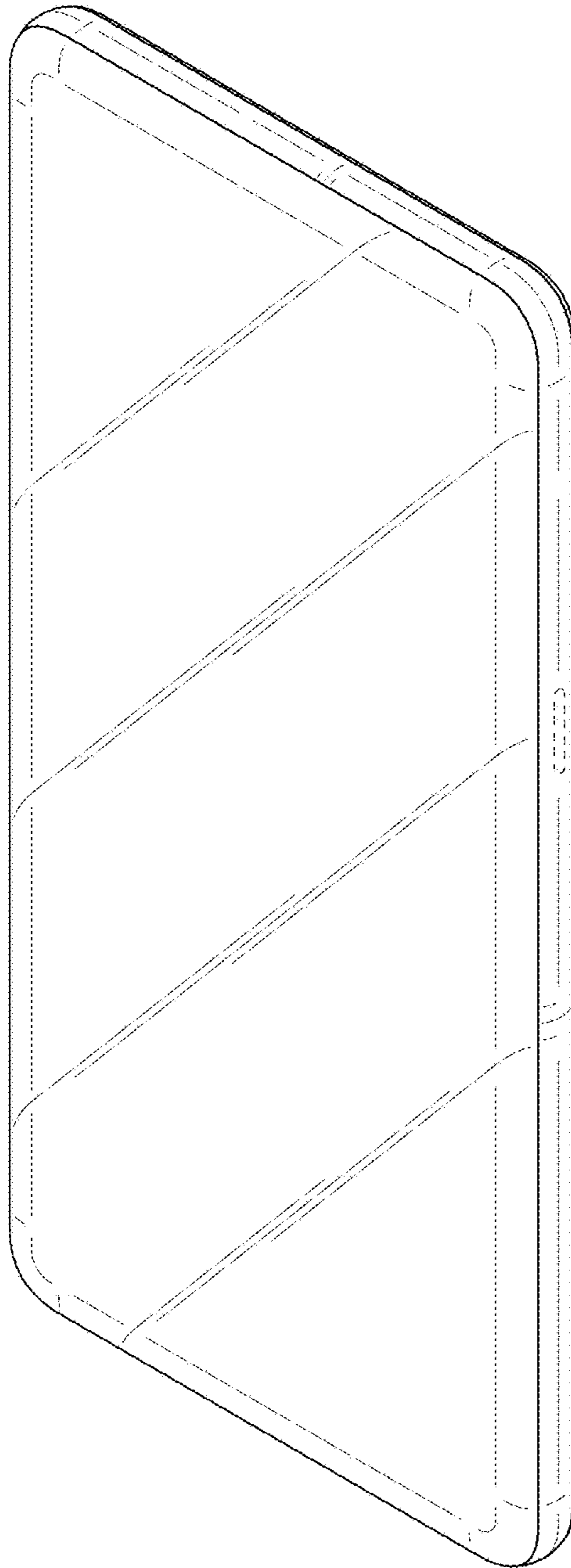

FIG. 26

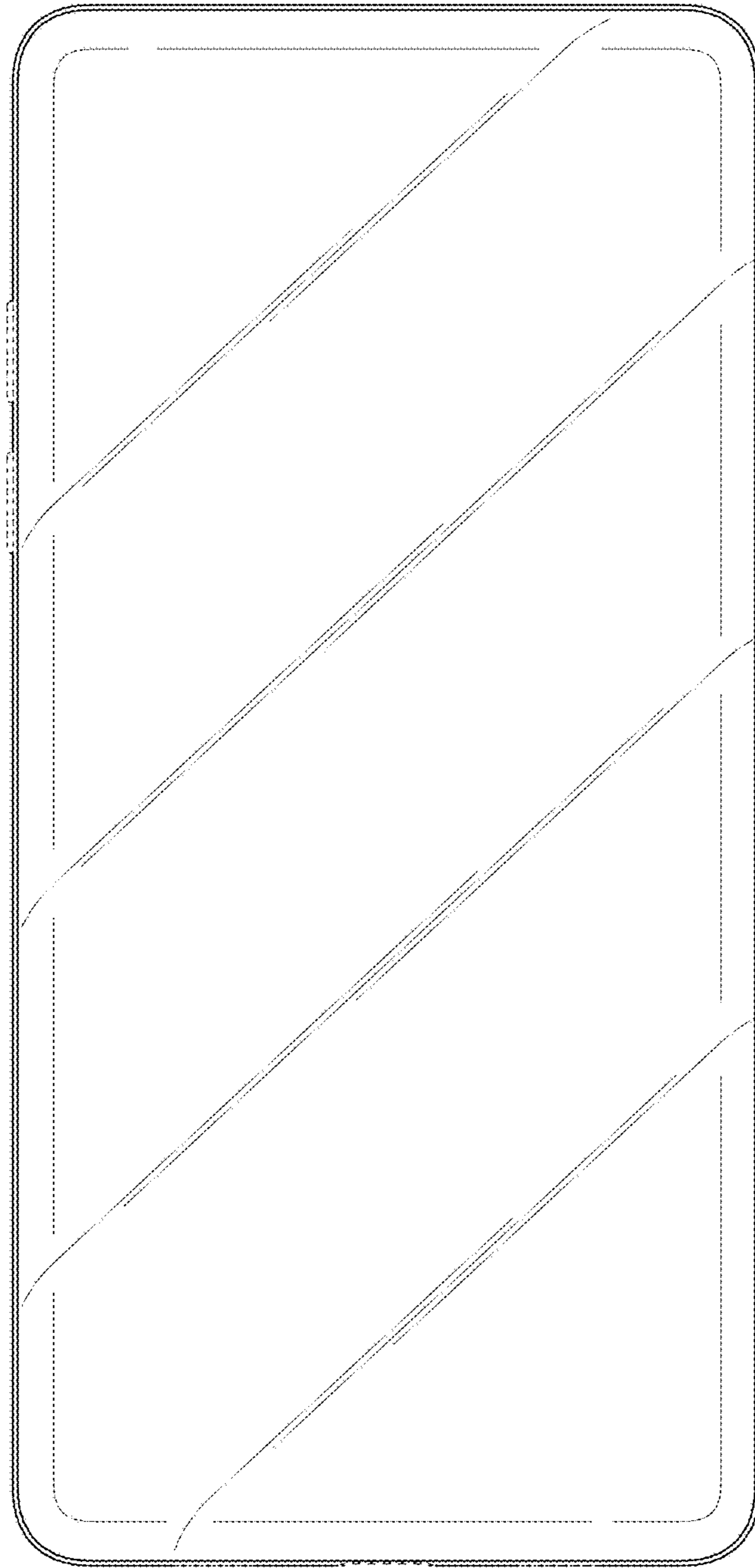

FIG. 27

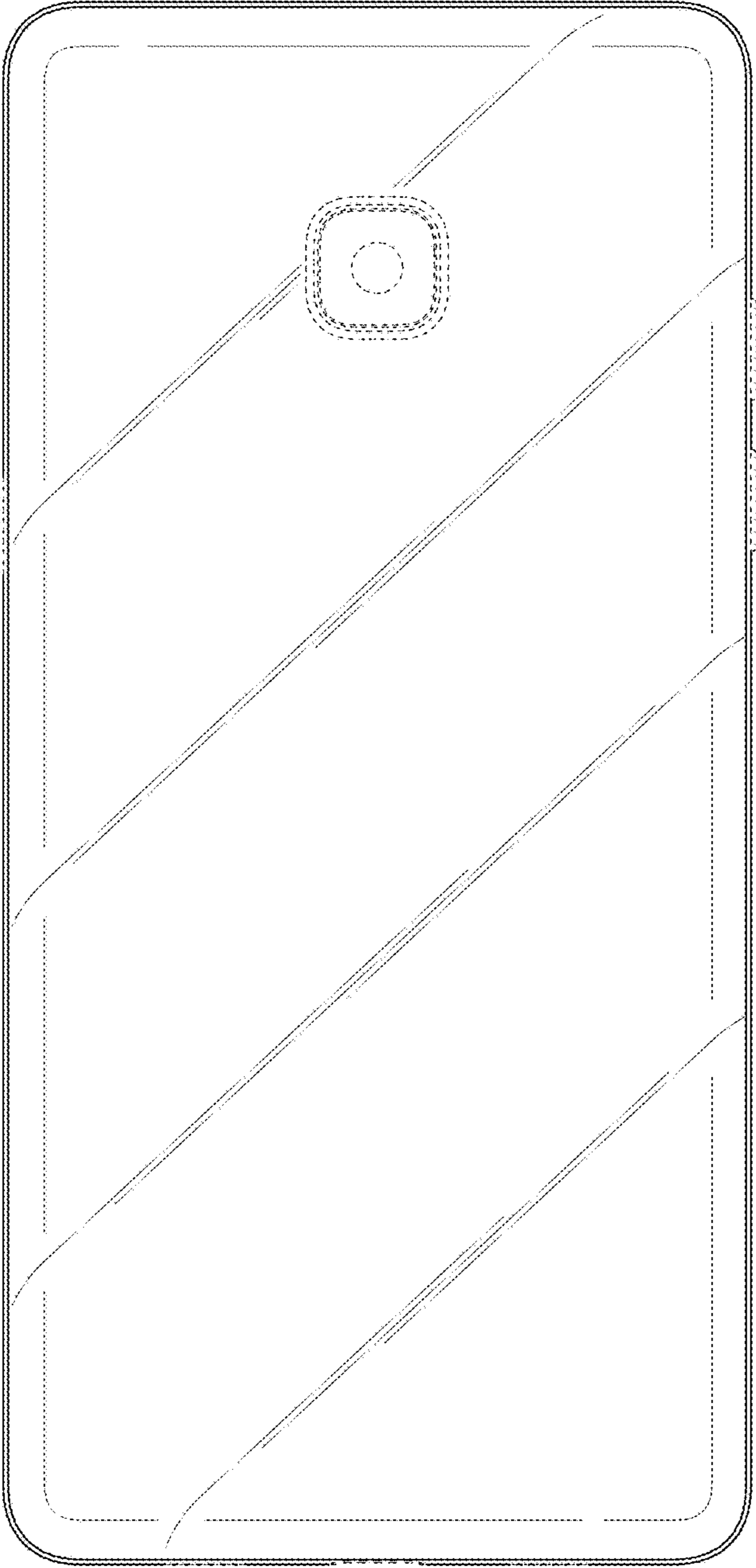

FIG. 28

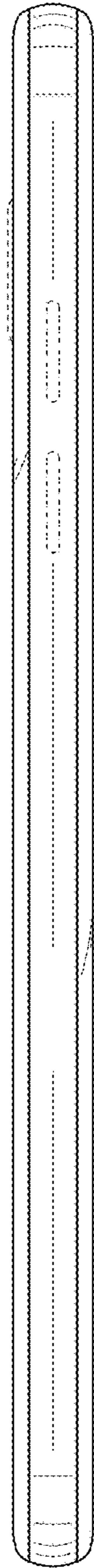

FIG. 29

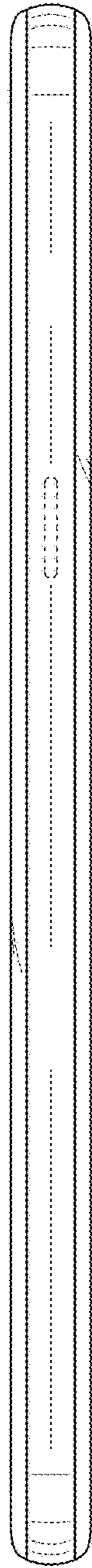

FIG. 30

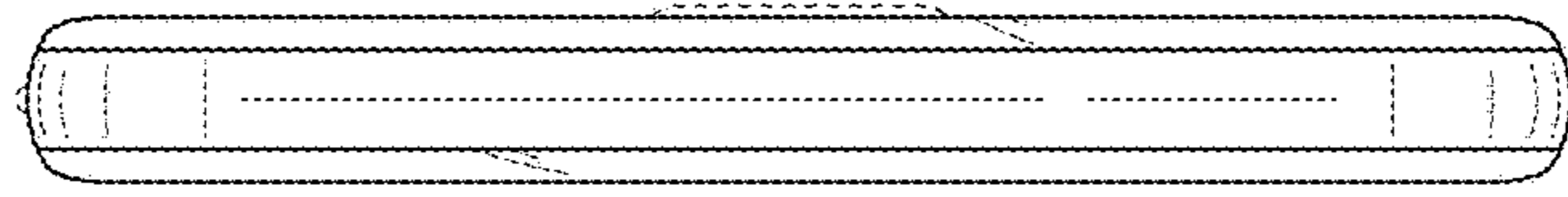

FIG. 31

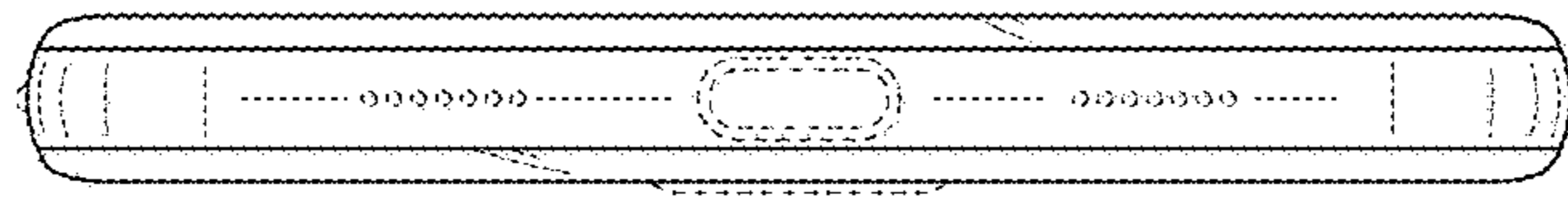

FIG. 32

