



US00D856882S

(12) **United States Design Patent** (10) **Patent No.:** **US D856,882 S**  
**Ninov et al.** (45) **Date of Patent:** **\*\* Aug. 20, 2019**

(54) **TAILGATE**

(71) Applicants: **Deyan Ninov**, Royal Oak, MI (US);  
**Everard J Scott**, Sterling Heights, MI  
(US); **Michael Gillam**, Oxford, MI  
(US); **Gregory A. Howell**, Farmington,  
MI (US)

(72) Inventors: **Deyan Ninov**, Royal Oak, MI (US);  
**Everard J Scott**, Sterling Heights, MI  
(US); **Michael Gillam**, Oxford, MI  
(US); **Gregory A. Howell**, Farmington,  
MI (US)

(73) Assignee: **FCA US LLC**, Auburn Hills, MI (US)

(\*\*) Term: **15 Years**

(21) Appl. No.: **29/673,660**

(22) Filed: **Dec. 17, 2018**

**Related U.S. Application Data**

(63) Continuation-in-part of application No. 29/626,553,  
filed on Nov. 17, 2017, now Pat. No. Des. 837,099,  
and a continuation-in-part of application No.  
29/626,566, filed on Nov. 17, 2017, now Pat. No. Des.  
836,036, and a continuation-in-part of application No.  
29/626,563, filed on Nov. 17, 2017, now Pat. No. Des.  
836,035, and a continuation-in-part of application No.  
29/626,557, filed on Nov. 17, 2017, now Pat. No. Des.  
836,034.

(51) **LOC (12) Cl.** ..... **12-16**

(52) **U.S. Cl.**  
USPC ..... **D12/196**

(58) **Field of Classification Search**  
USPC ..... D12/90-93, 98, 164, 196  
CPC ..... B60K 11/085; B62D 35/00  
See application file for complete search history.

(56) **References Cited**

**U.S. PATENT DOCUMENTS**

D397,978 S *	9/1998	Helgeson .....	D12/196
D420,317 S *	2/2000	Ney .....	D12/196
D494,521 S *	8/2004	Metros .....	D12/196
D494,910 S *	8/2004	Metros .....	D12/196
D527,697 S *	9/2006	Metros .....	D12/196
D541,719 S *	5/2007	McChesney .....	D12/196
D556,110 S *	11/2007	Schiavone .....	D12/196
D613,225 S *	4/2010	Wu .....	D12/196
D614,556 S *	4/2010	Wu .....	D12/196
D710,283 S *	8/2014	O'Donnell .....	D12/196
D758,271 S *	6/2016	McMahan .....	D12/196
D840,306 S *	2/2019	Kozub .....	D12/196

\* cited by examiner

*Primary Examiner* — Garth Rademaker

*Assistant Examiner* — Melvin L Davis

(74) *Attorney, Agent, or Firm* — Ralph E Smith

(57) **CLAIM**

The ornamental design for a tailgate, as shown and described.

**DESCRIPTION**

FIG. 1 is a rear perspective view of a tailgate showing our new design;  
FIG. 2 is a rear view thereof;  
FIG. 3 is a front view thereof;  
FIG. 4 is a top view thereof;  
FIG. 5 is a bottom view thereof; and,  
FIG. 6 is a side view thereof.

The broken lines depicts portions of the tailgate that form no part of the claimed design.

**1 Claim, 5 Drawing Sheets**

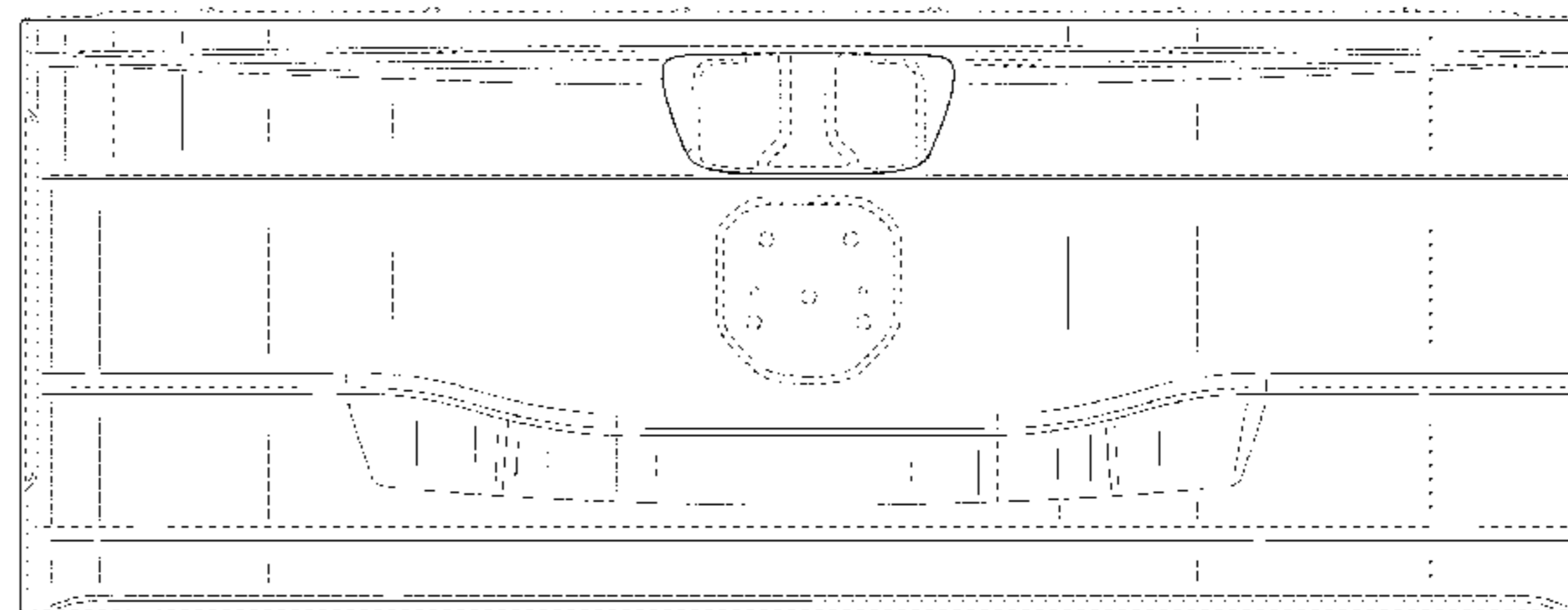
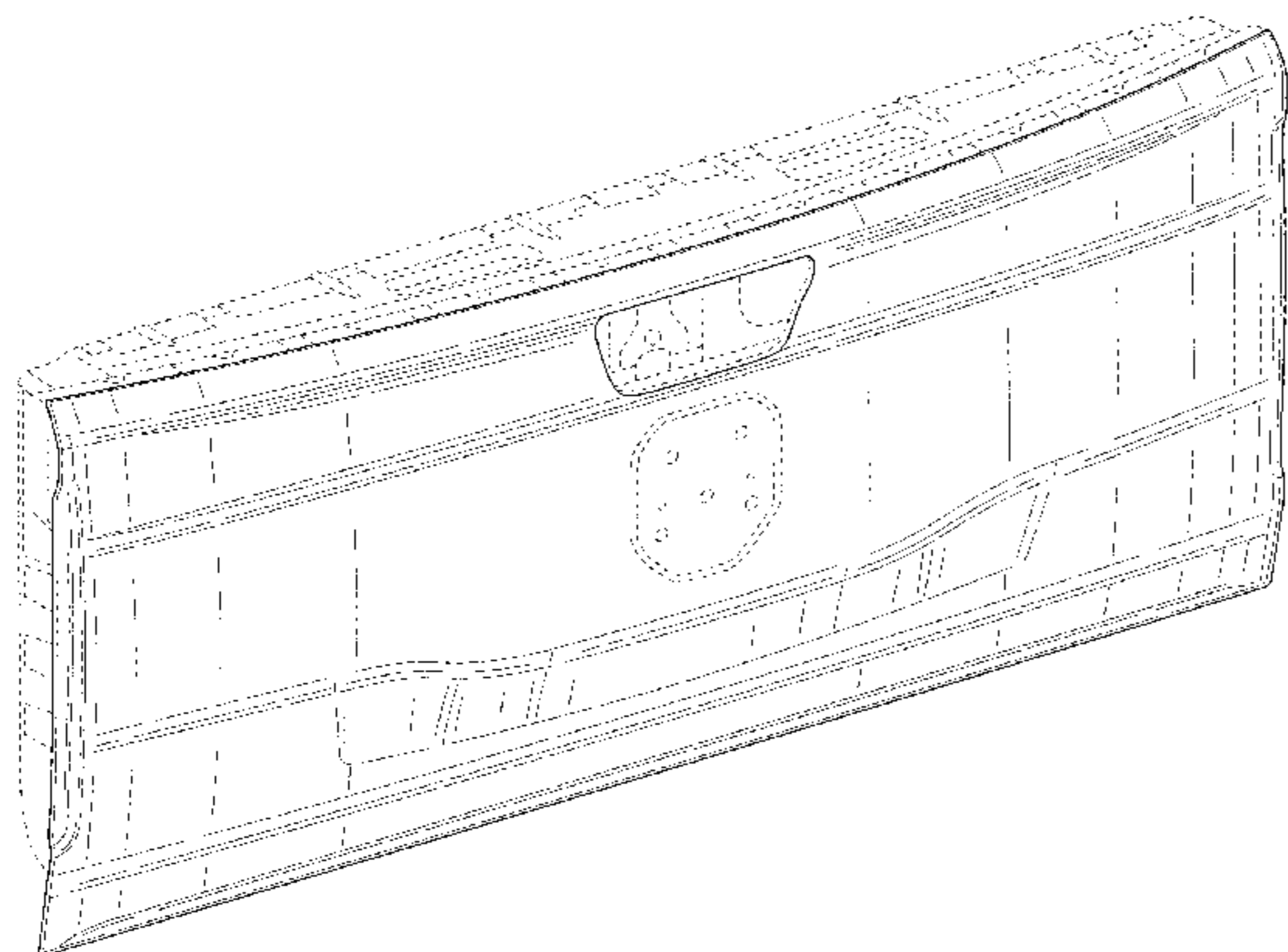

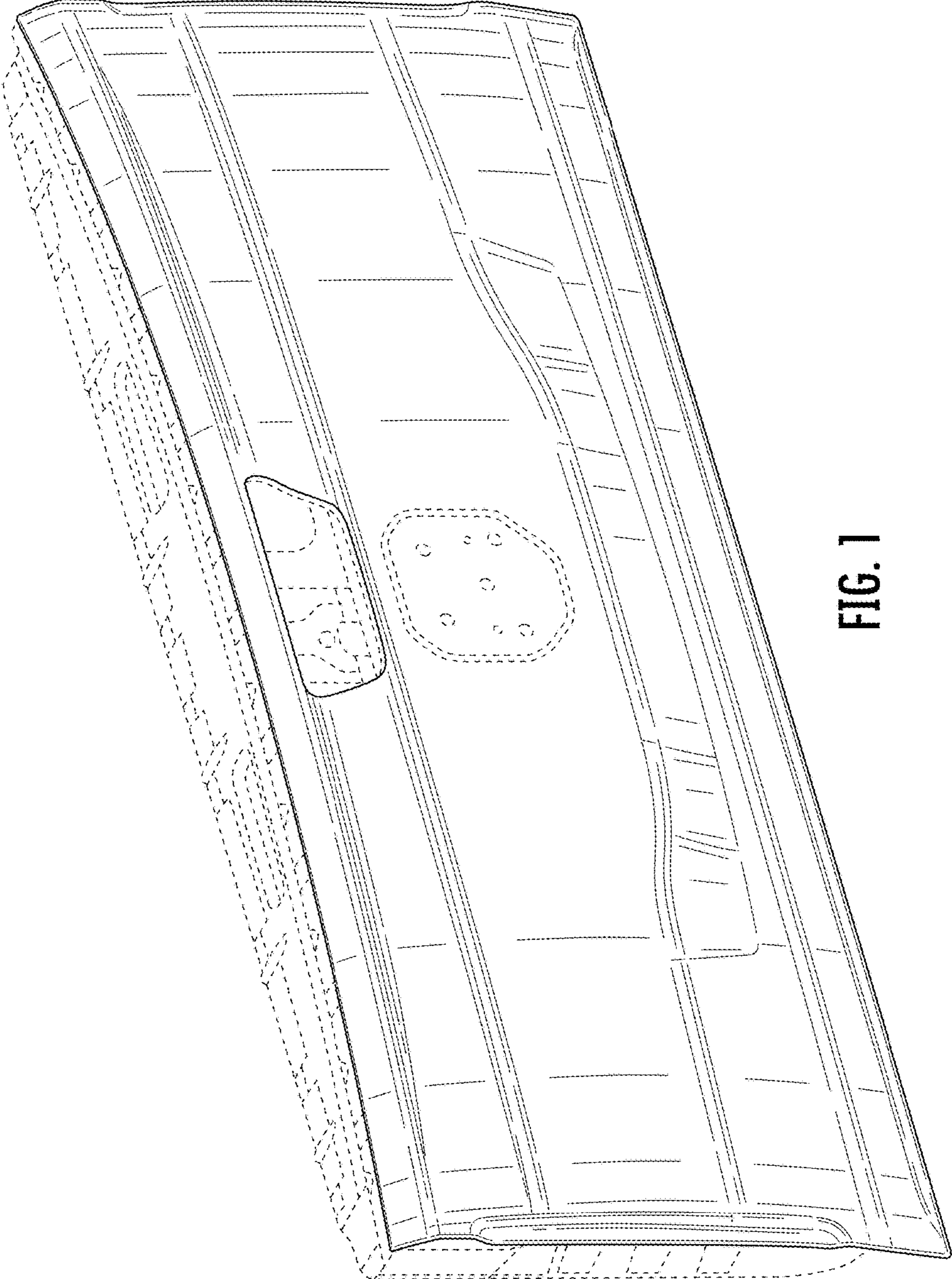

FIG. 1

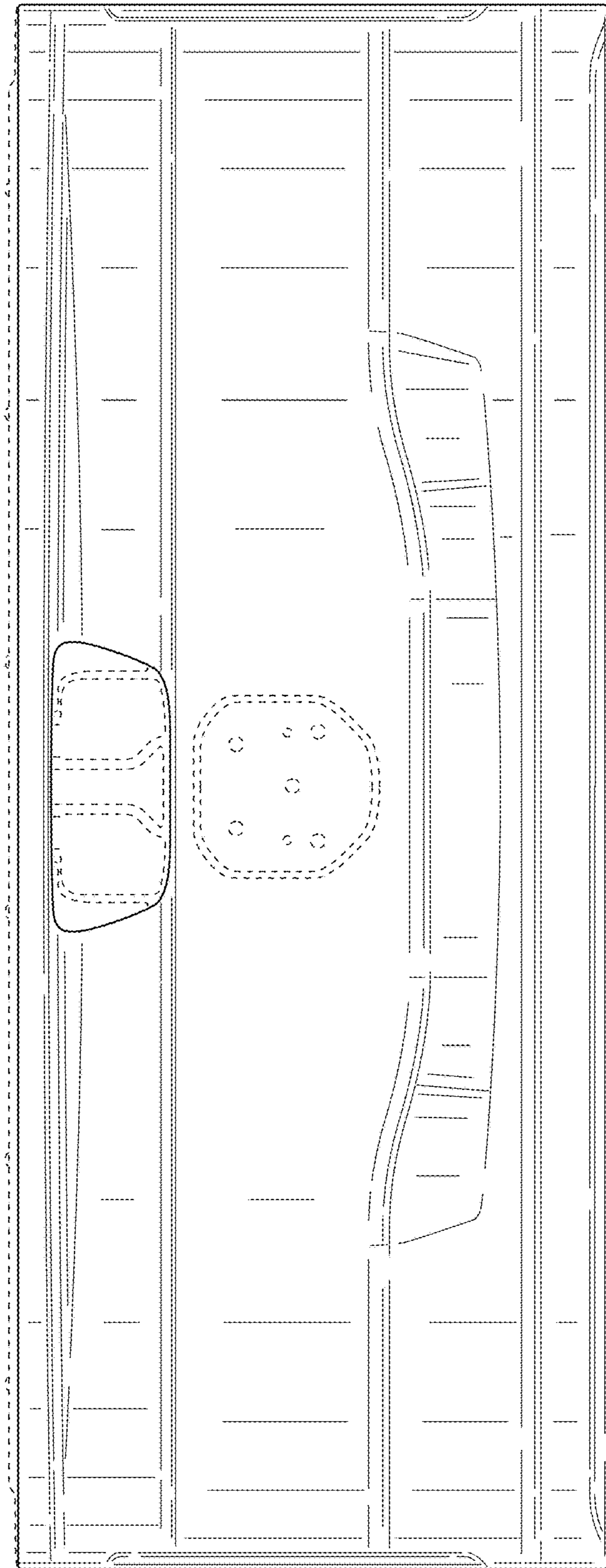

FIG. 2



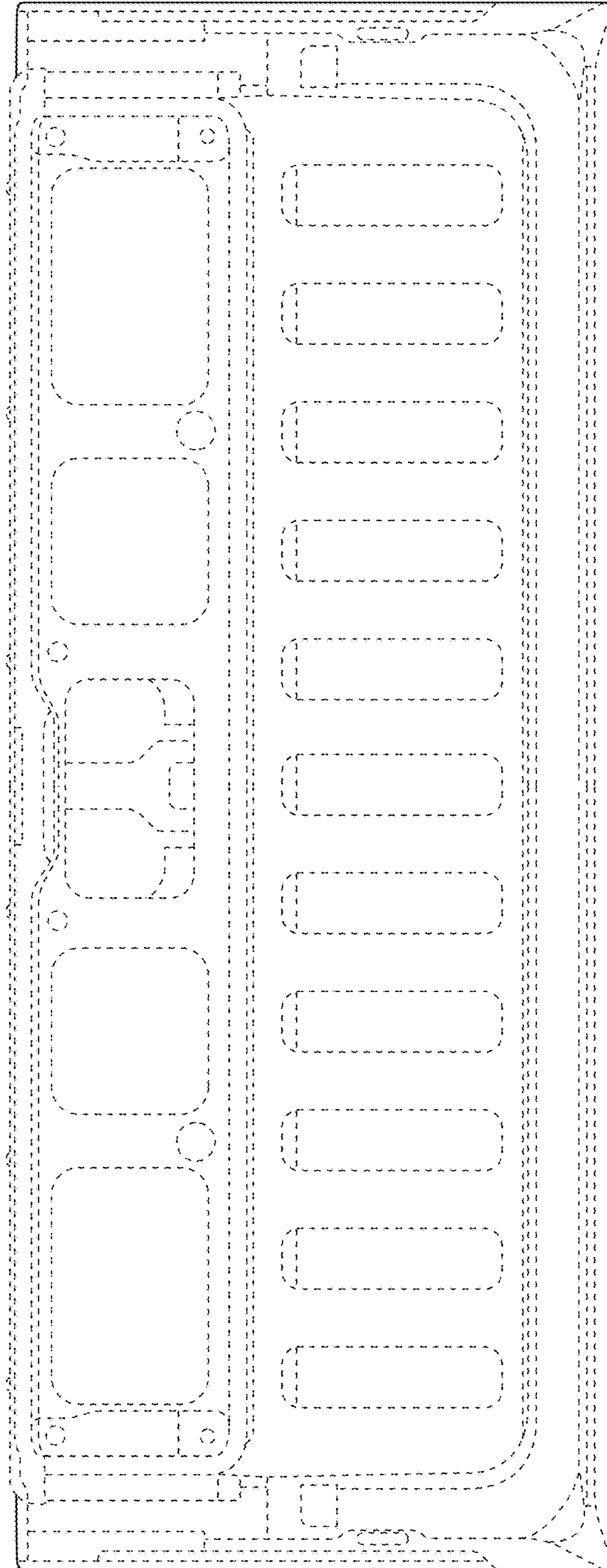

FIG. 3

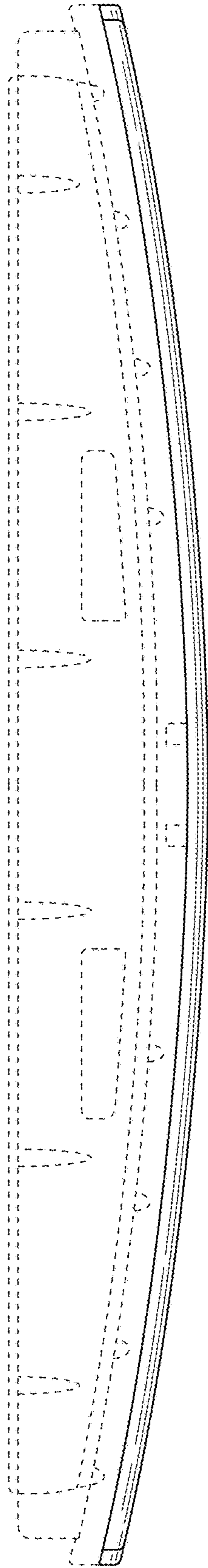

FIG. 4

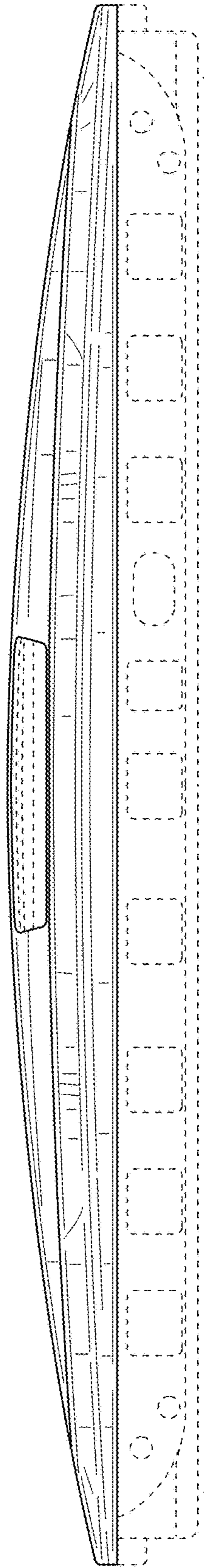

FIG. 5

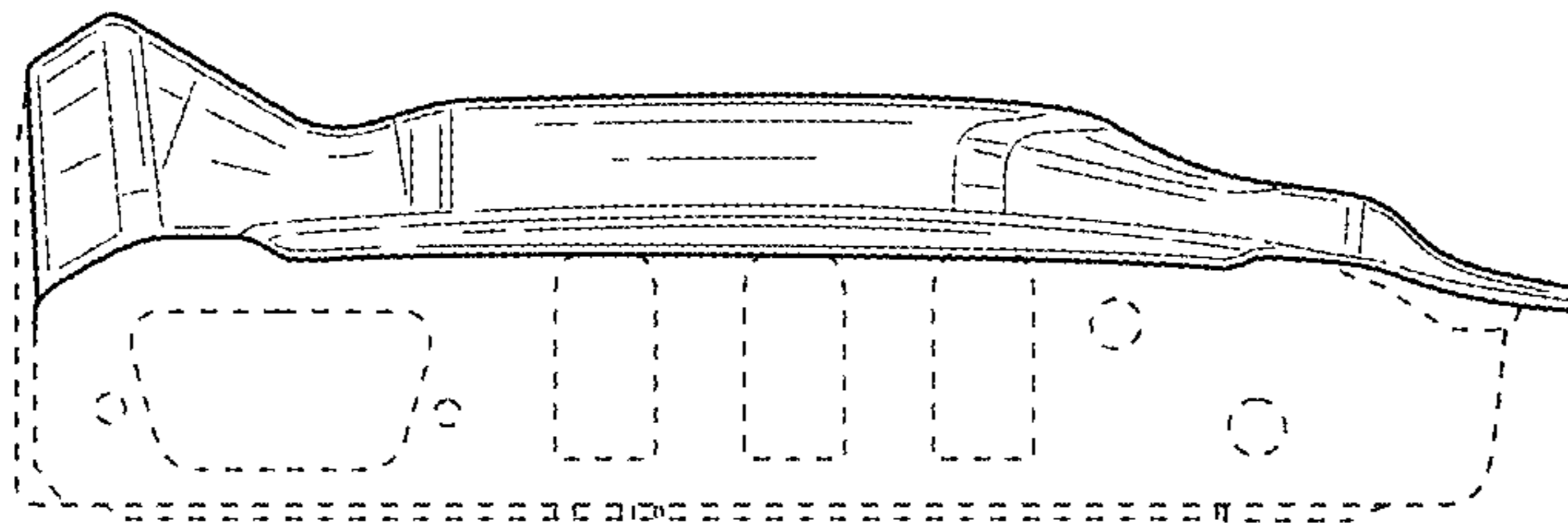

FIG. 6