

US00D856817S

(12) **United States Design Patent**  
**Sheerin et al.**

(10) **Patent No.:** **US D856,817 S**

(45) **Date of Patent:** **\*\* Aug. 20, 2019**

(54) **POUCH AND CLEANING COMPOSITION**

(71) Applicant: **S. C. Johnson & Son, Inc.**, Racine, WI (US)

(72) Inventors: **Shabistan Sheerin**, Mequon, WI (US);  
**Douglas A. Soller**, Racine, WI (US);  
**John Bruno**, Mineola, NY (US); **Diana Maureen Luistro**, Elmhurst, NY (US);  
**Leonard Joseph DiChiara**, Chatham, NJ (US); **Jason Craig Campbell**, Chicago, IL (US); **Gregory A. Falduto**, Grayslake, IL (US)

(73) Assignee: **S. C. Johnson & Son, Inc.**, Racine, WI (US)

(\*\*) Term: **15 Years**

(21) Appl. No.: **29/648,762**

(22) Filed: **May 23, 2018**

(51) **LOC (12) Cl.** ..... **09-05**

(52) **U.S. Cl.**  
USPC ..... **D9/707**

(58) **Field of Classification Search**  
USPC ..... D9/702-714, 414-416, 428, 421,  
D9/424-426, 430-432, 759; D28/4-8,  
D28/8.1-8.2  
CPC ..... C11D 17/0065-17/0091; C11D  
17/00-17/0039; C11D 17/04-17/047  
See application file for complete search history.

(56) **References Cited**

**U.S. PATENT DOCUMENTS**

D821,029 S \* 6/2018 Crivolio ..... D28/8.1  
D825,847 S \* 8/2018 Wissmann ..... D28/8.1

D829,984 S \* 10/2018 Gerhards ..... D28/8.1  
D833,068 S \* 11/2018 Sunder ..... D28/8.1  
D838,038 S \* 1/2019 Tarnowsky ..... D28/8.1  
D841,237 S \* 2/2019 Eggemeyer ..... D28/8.1

\* cited by examiner

*Primary Examiner* — Abraham Bahta

(57) **CLAIM**

The ornamental design for a pouch and cleaning composition, as shown and described.

**DESCRIPTION**

FIG. 1 is a top, front, right perspective view of a pouch and cleaning composition showing our new design;  
FIG. 2 is a top view thereof;  
FIG. 3 is a bottom view thereof;  
FIG. 4 is a rear view thereof;  
FIG. 5 is a front view thereof;  
FIG. 6 is a right side view thereof;  
FIG. 7 is a left side view thereof;  
FIG. 8 is a top, front, right perspective view of a first alternative claimed configuration of a pouch and cleaning composition showing our new design;  
FIG. 9 is a top view thereof;  
FIG. 10 is a bottom view thereof;  
FIG. 11 is a rear view thereof;  
FIG. 12 is a front view thereof;  
FIG. 13 is a right side view thereof; and,  
FIG. 14 is a left side view thereof.

The broken lines immediately adjacent to the shaded area define the bounds of the claimed design and form no part thereof. The broken lines depicting the remainder of the pouch and cleaning composition show features that form no part of the claimed design. The contrast in shading represents a contrast in appearance only and does not represent any particular color, material, texture or finish.

**1 Claim, 8 Drawing Sheets**

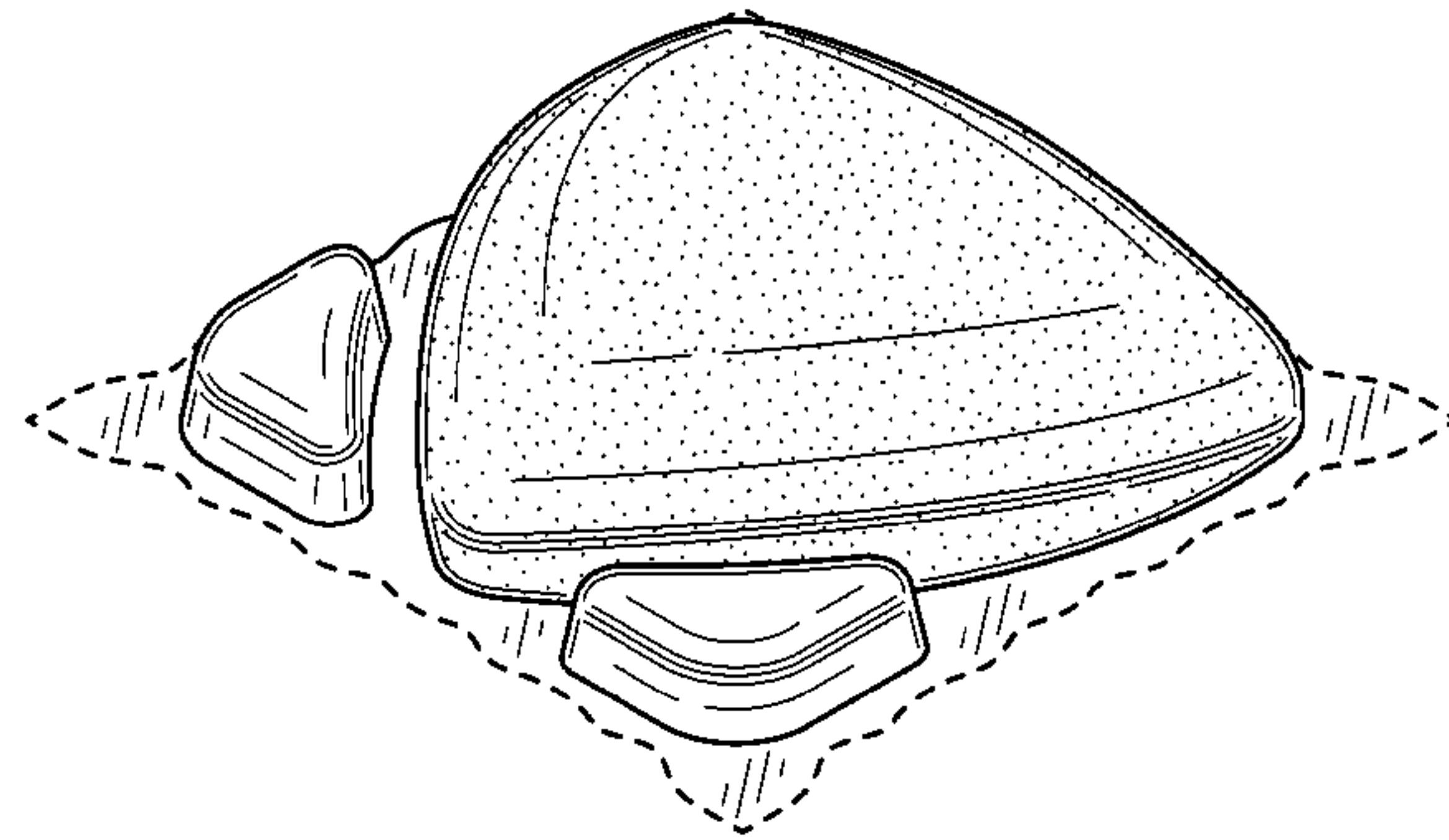
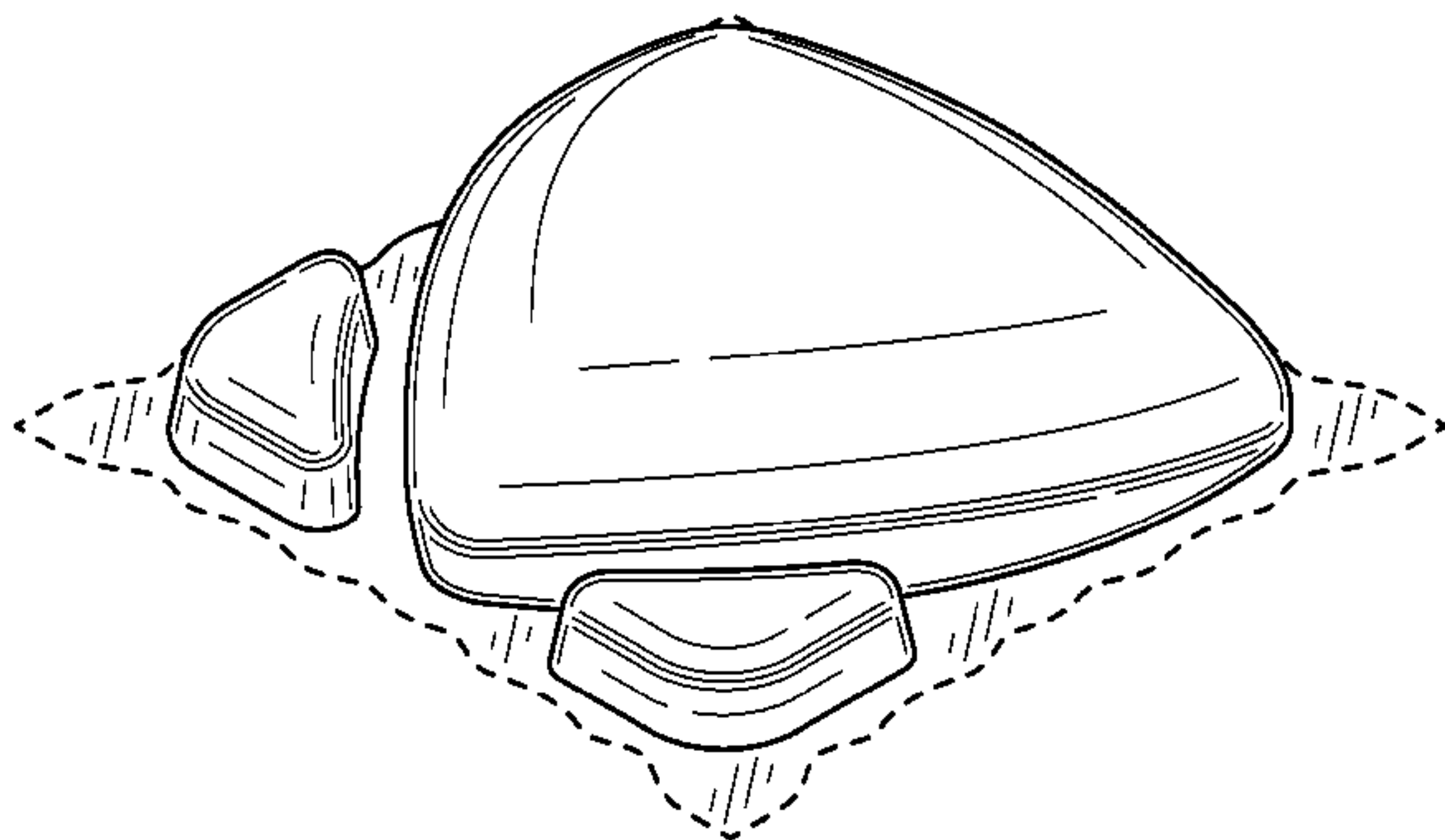

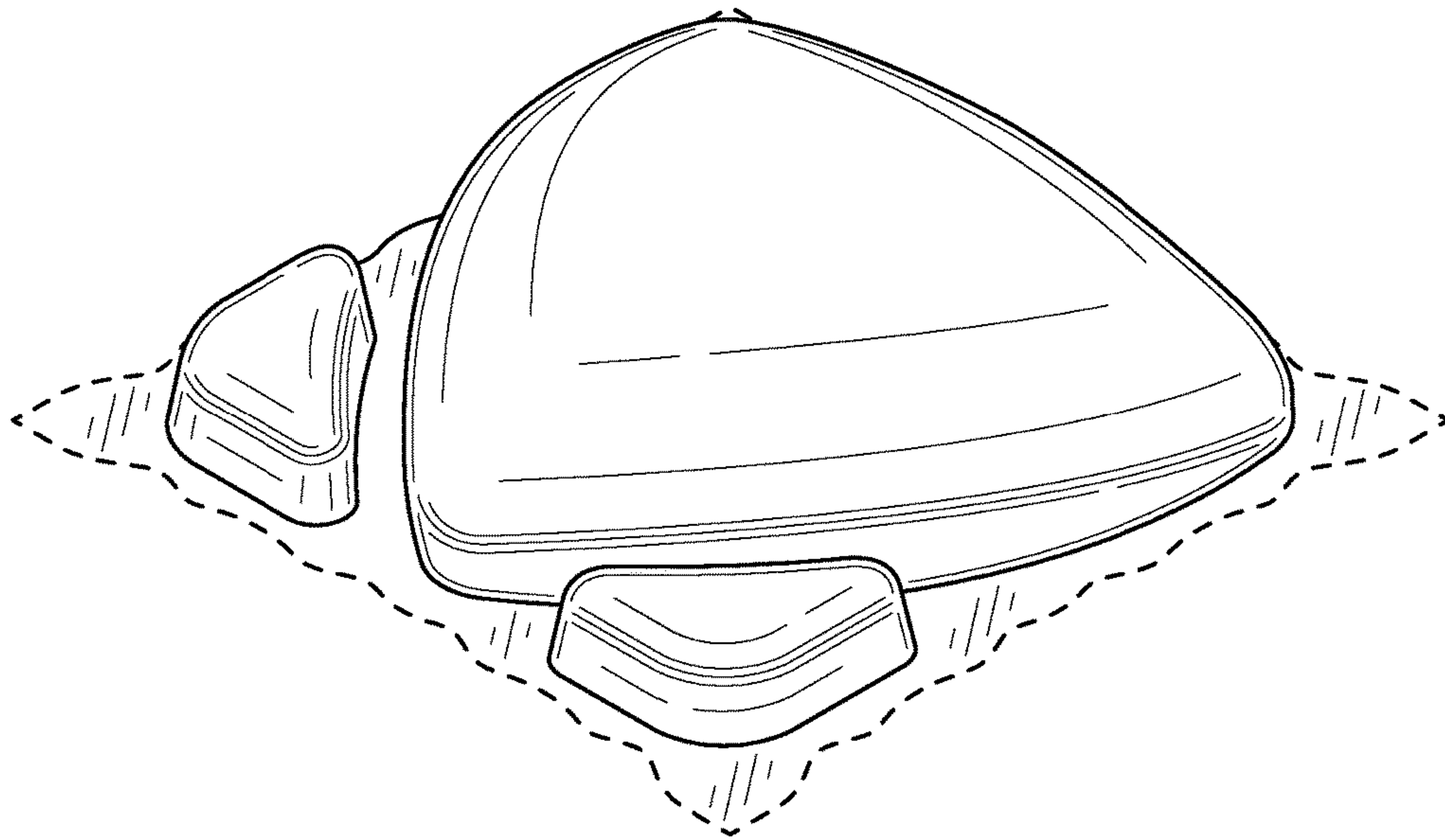

FIG. 1

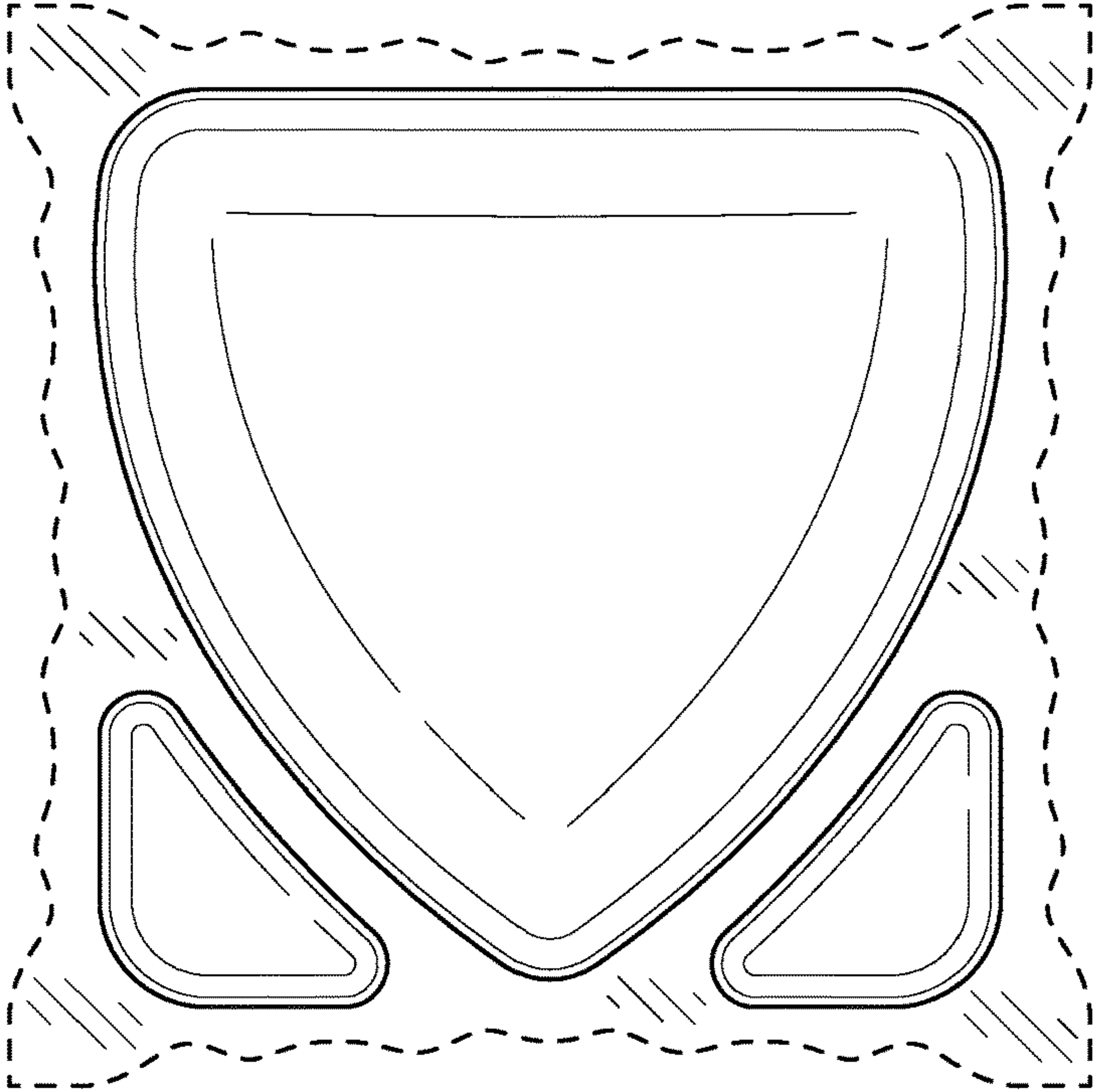

FIG. 2

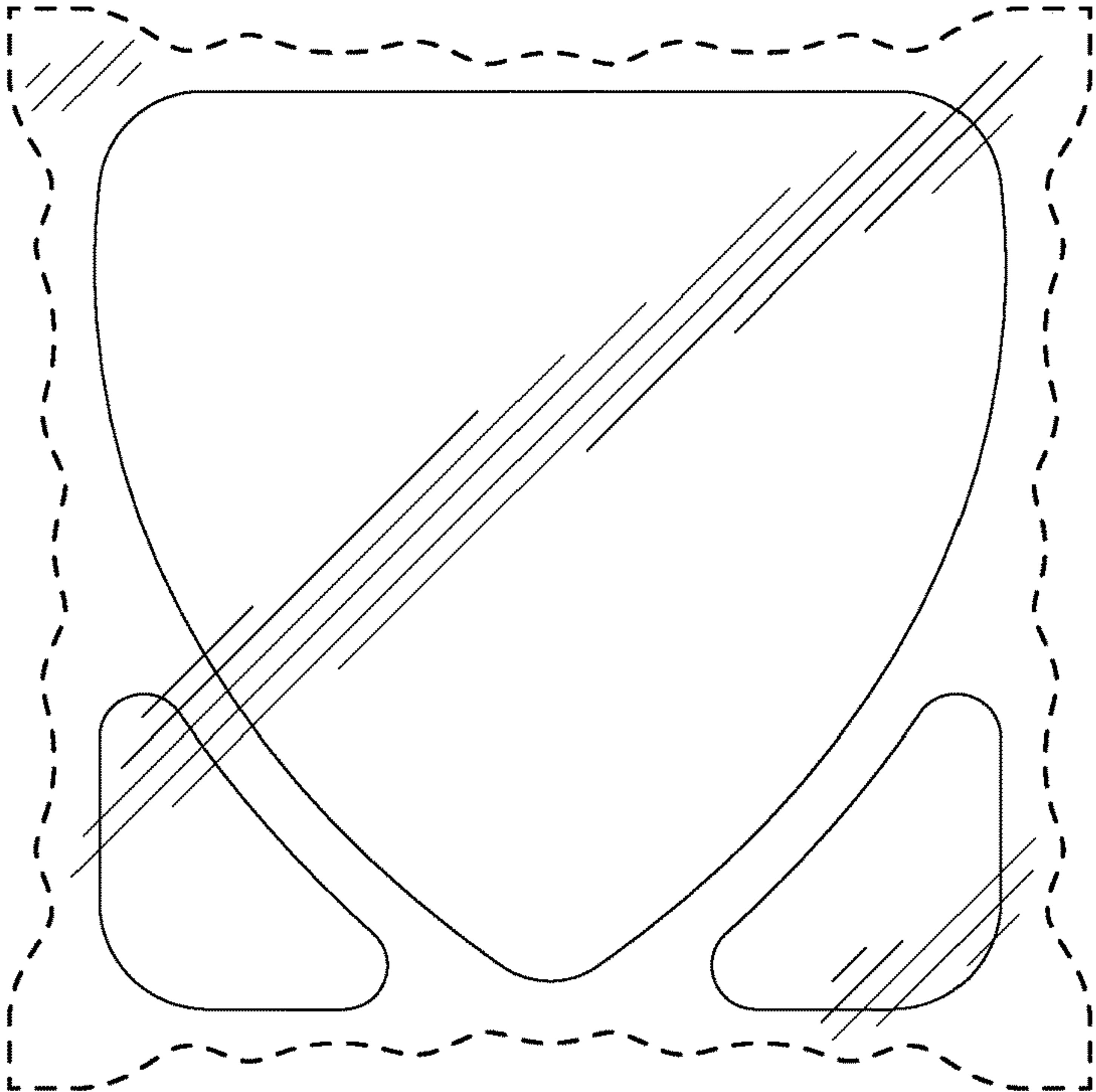

FIG. 3

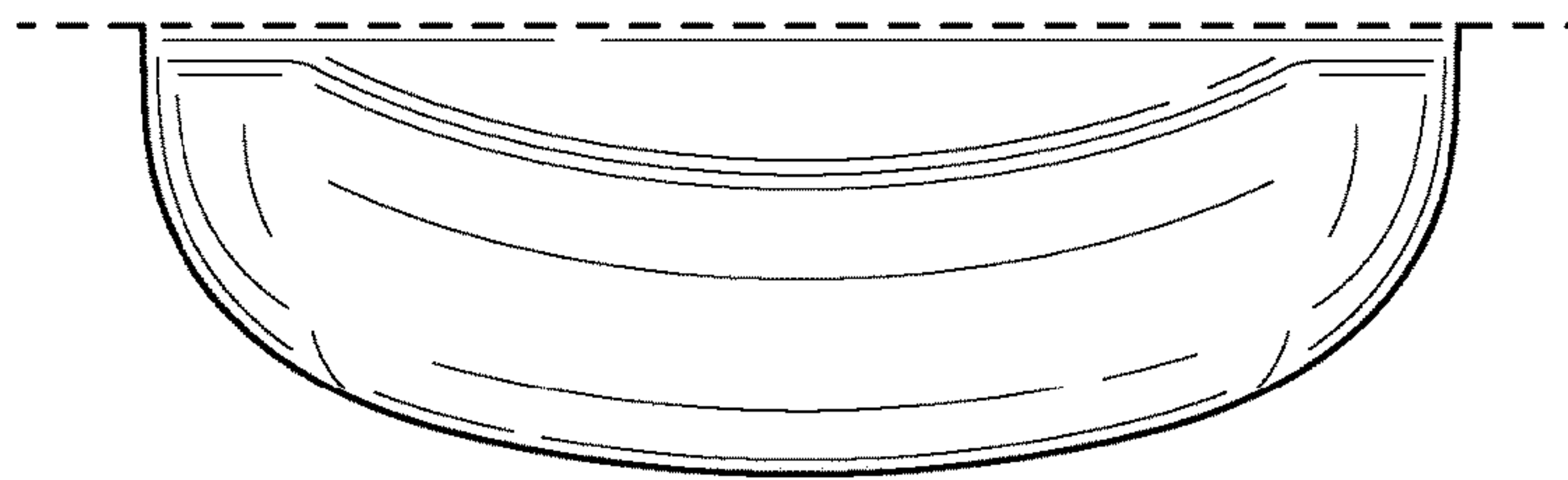

FIG. 4

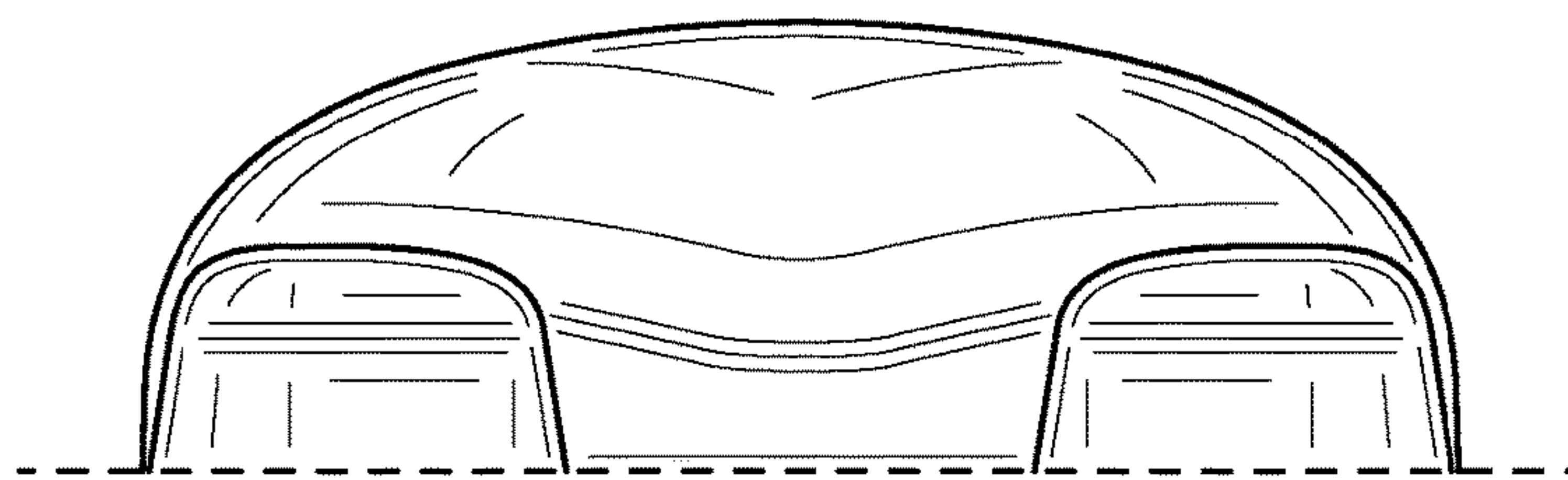

FIG. 5

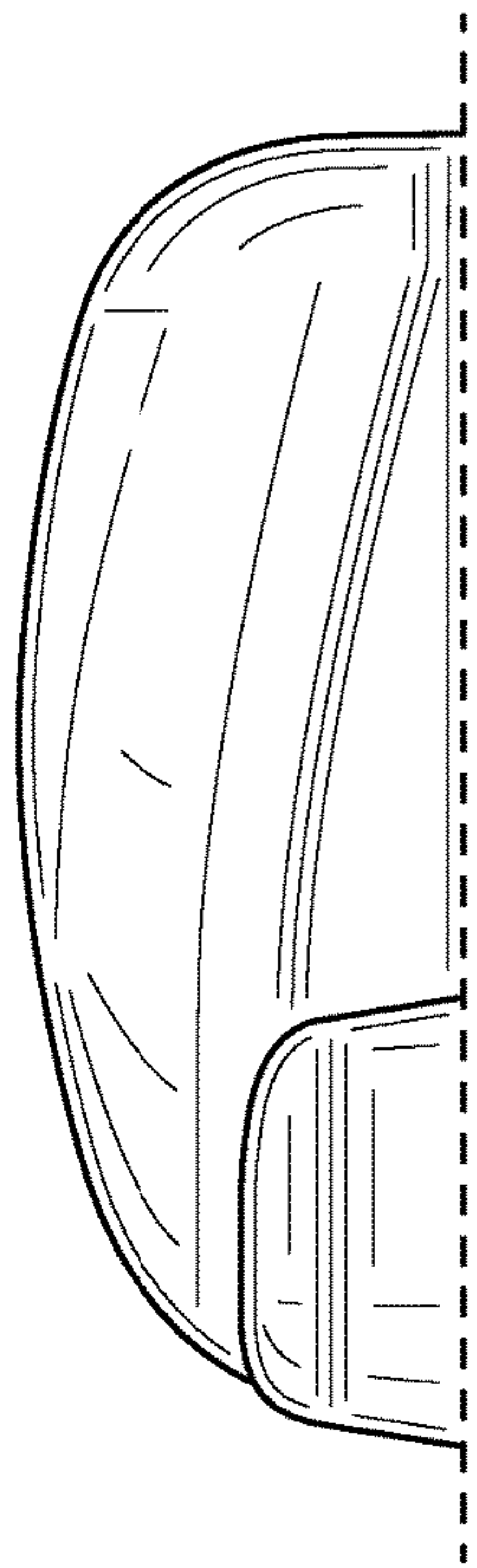

FIG. 6

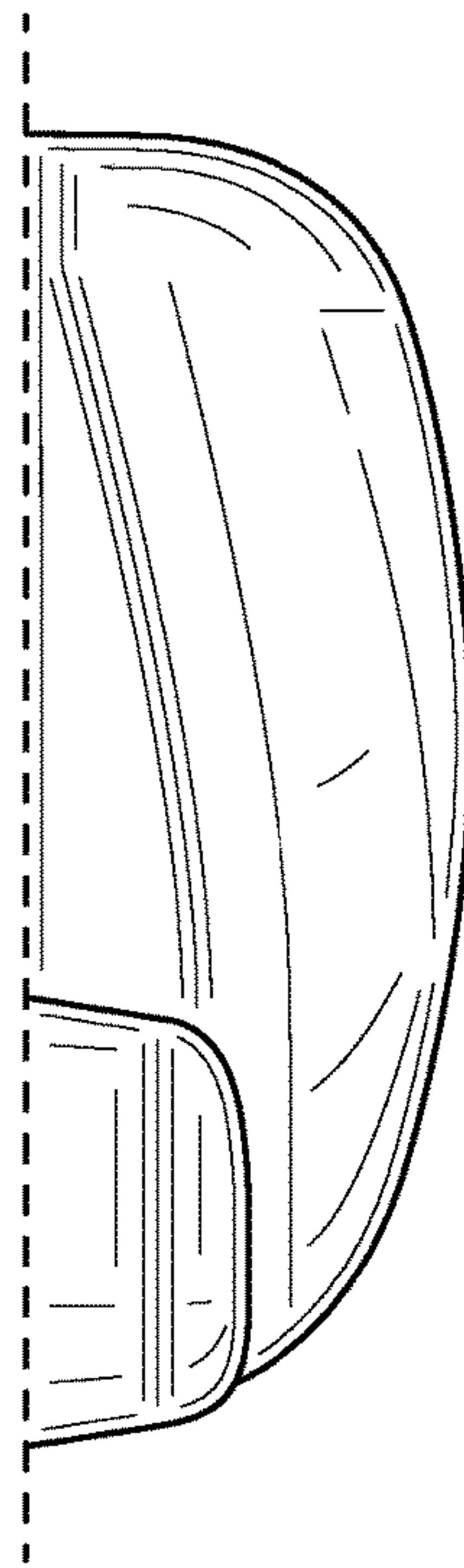

FIG. 7



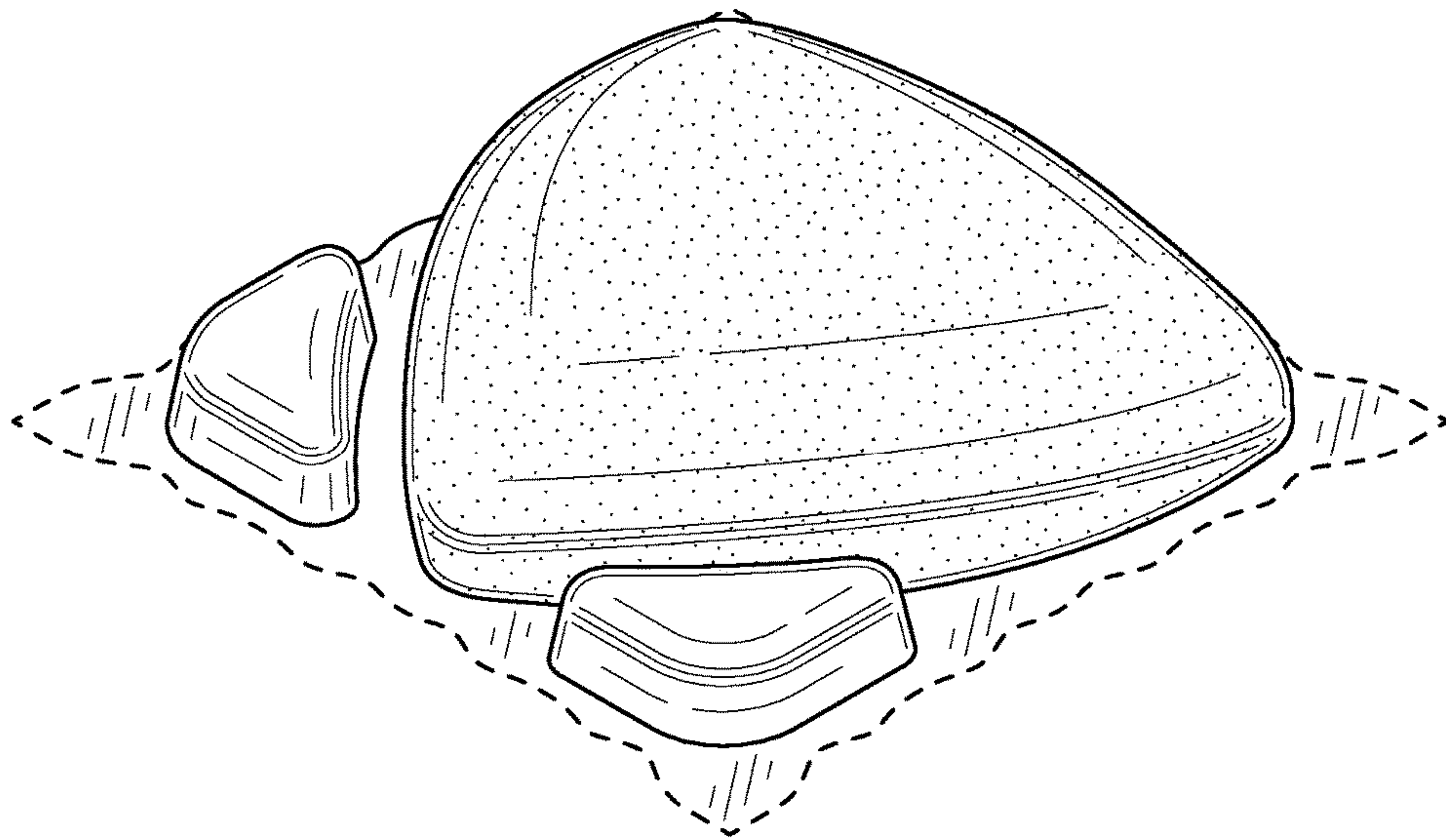

FIG. 8

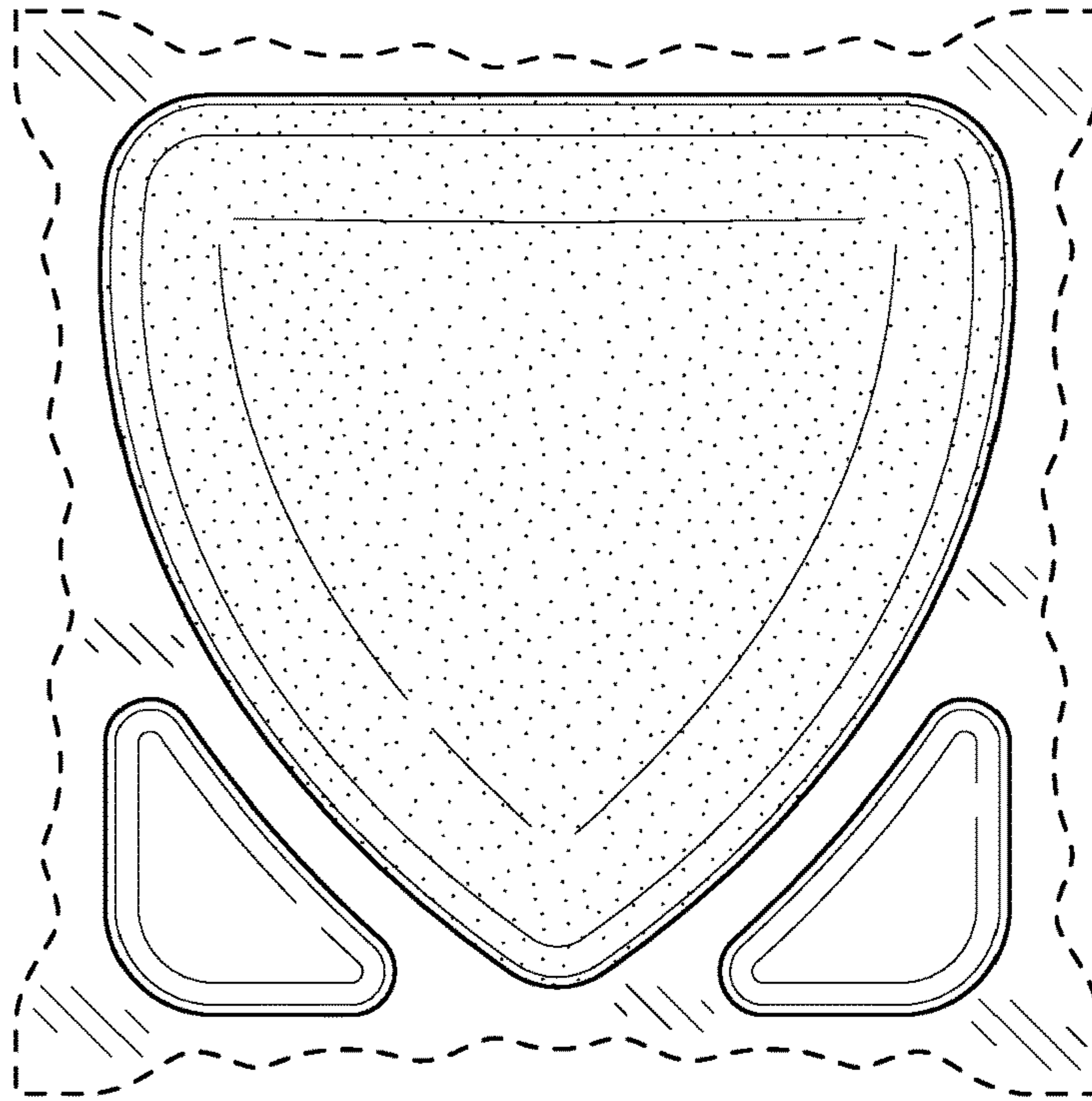

FIG. 9

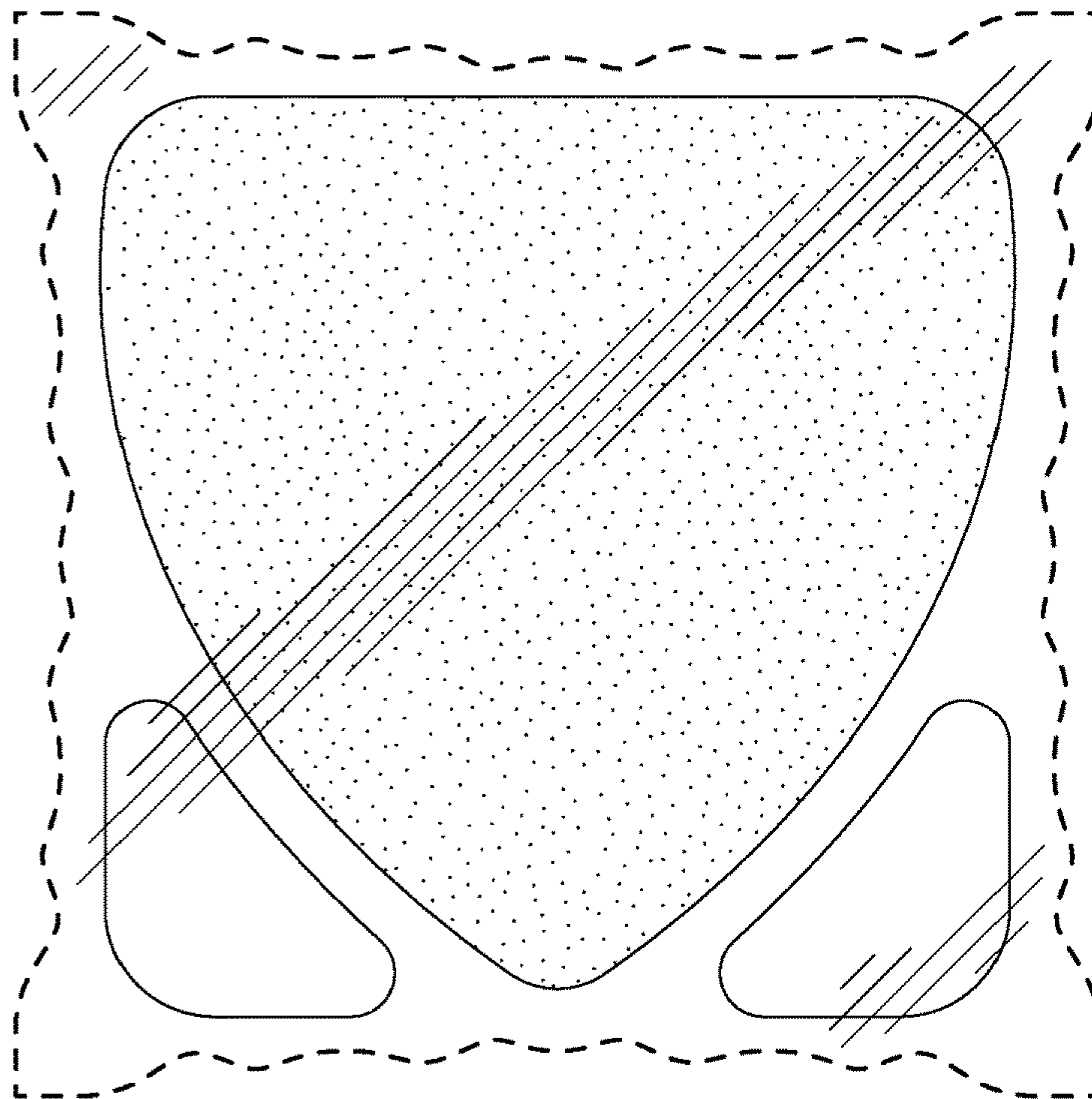

FIG. 10

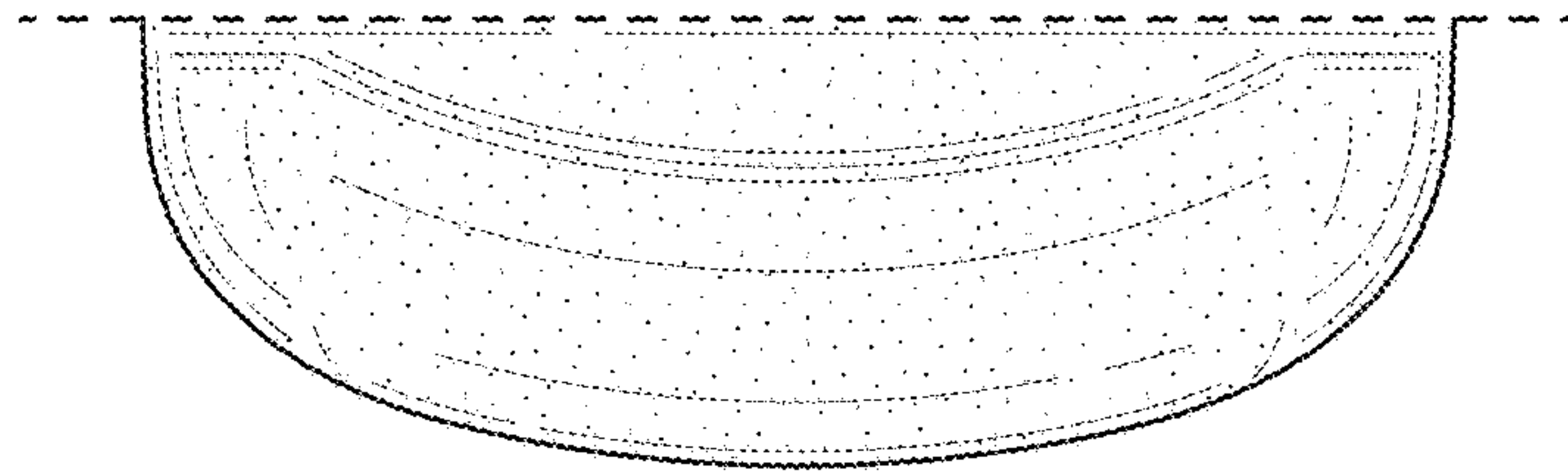

FIG. 11

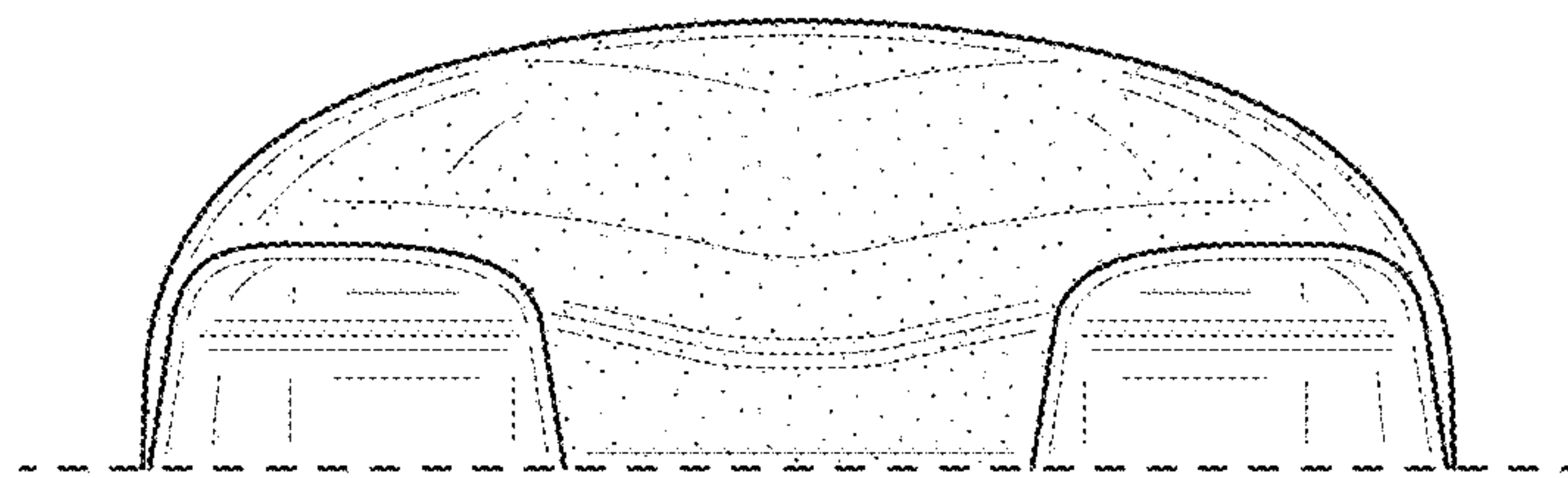

FIG. 12



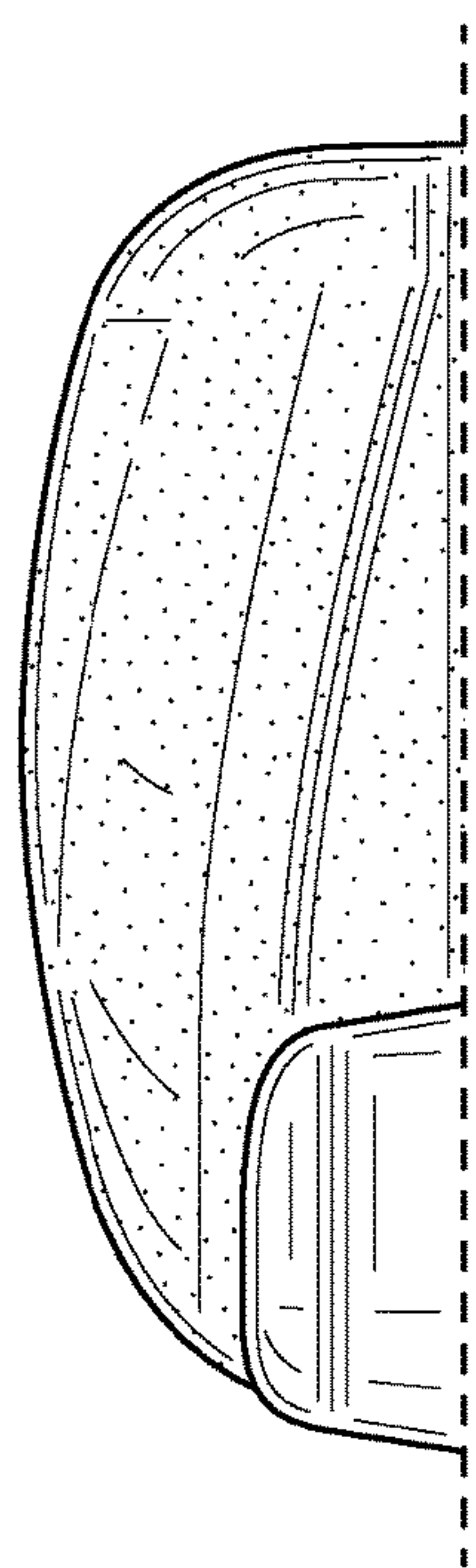

FIG. 13

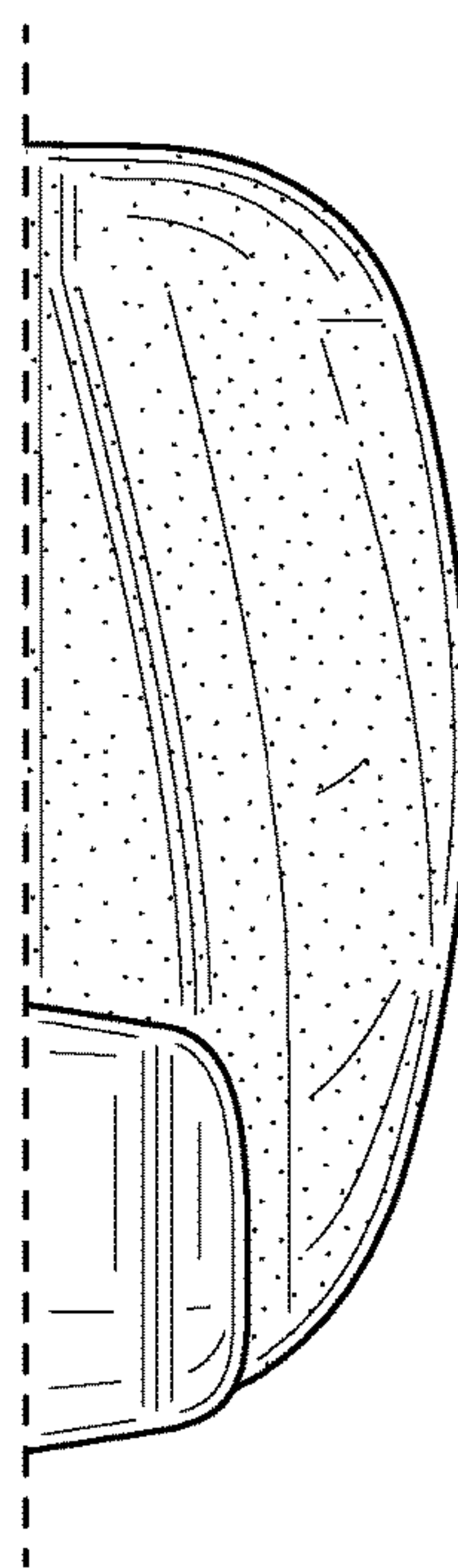

FIG. 14