

US00D856760S

(12) **United States Design Patent** (10) **Patent No.:** **US D856,760 S**  
**Strickland** (45) **Date of Patent:** **\*\* Aug. 20, 2019**

(54) **FISH SCALER ATTACHMENT**  
(71) Applicant: **Benjamin Williams Strickland,**  
Smoaks, SC (US)  
(72) Inventor: **Benjamin Williams Strickland,**  
Smoaks, SC (US)  
(\*\*) Term: **15 Years**  
(21) Appl. No.: **29/616,454**  
(22) Filed: **Sep. 6, 2017**  
(51) **LOC (12) Cl.** ..... **07-04**  
(52) **U.S. Cl.**  
USPC ..... **D7/693**  
(58) **Field of Classification Search**  
USPC ..... D7/680–696, 368, 669; D8/14, 16, 33,  
D8/40, 41, 98  
CPC ..... A22C 25/025; A22C 25/006; A22C 25/17;  
A22C 25/02  
See application file for complete search history.

3,761,976 A \* 10/1973 D'Amico ..... A22C 25/025  
206/216  
D252,787 S \* 9/1979 Jefferson ..... D7/696  
5,230,652 A \* 7/1993 Alam ..... A22C 25/02  
452/105  
D491,426 S \* 6/2004 Kirton ..... D7/693  
7,179,162 B1 \* 2/2007 Twiner ..... A22C 25/025  
452/105  
2011/0189931 A1 \* 8/2011 Nuriel ..... A22C 25/02  
452/103

\* cited by examiner

*Primary Examiner* — Terry A Wallace

(74) *Attorney, Agent, or Firm* — Gregory Finch; Finch  
Paolino, LLC

(57) **CLAIM**

The ornamental design for a fish scaler attachment, as shown  
and described.

**DESCRIPTION**

FIG. 1 is an isometric view of the claimed fish scaler  
attachment, embodying the present design;  
FIG. 2 is a left side view thereof;  
FIG. 3 is a right side view thereof;  
FIG. 4 is a top down plan view thereof;  
FIG. 5 is a bottom up plan view thereof;  
FIG. 6 is a rear view thereof; and,  
FIG. 7 is a front view thereof.

**1 Claim, 6 Drawing Sheets**

(56) **References Cited**  
U.S. PATENT DOCUMENTS  
1,519,689 A \* 12/1924 Maxson ..... A22C 25/025  
15/236.08  
2,516,414 A \* 7/1950 Pilliod ..... A22C 25/025  
119/631

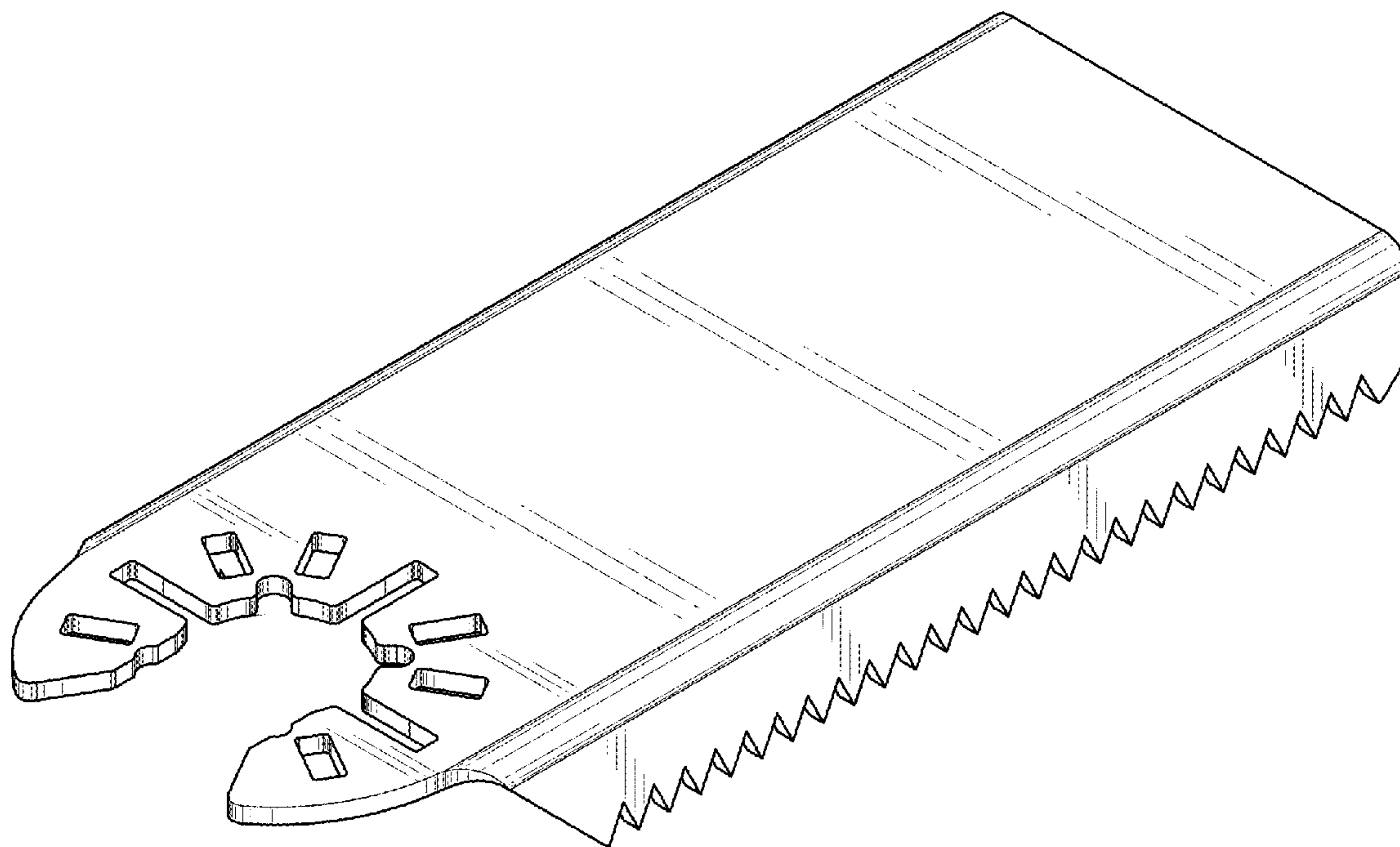

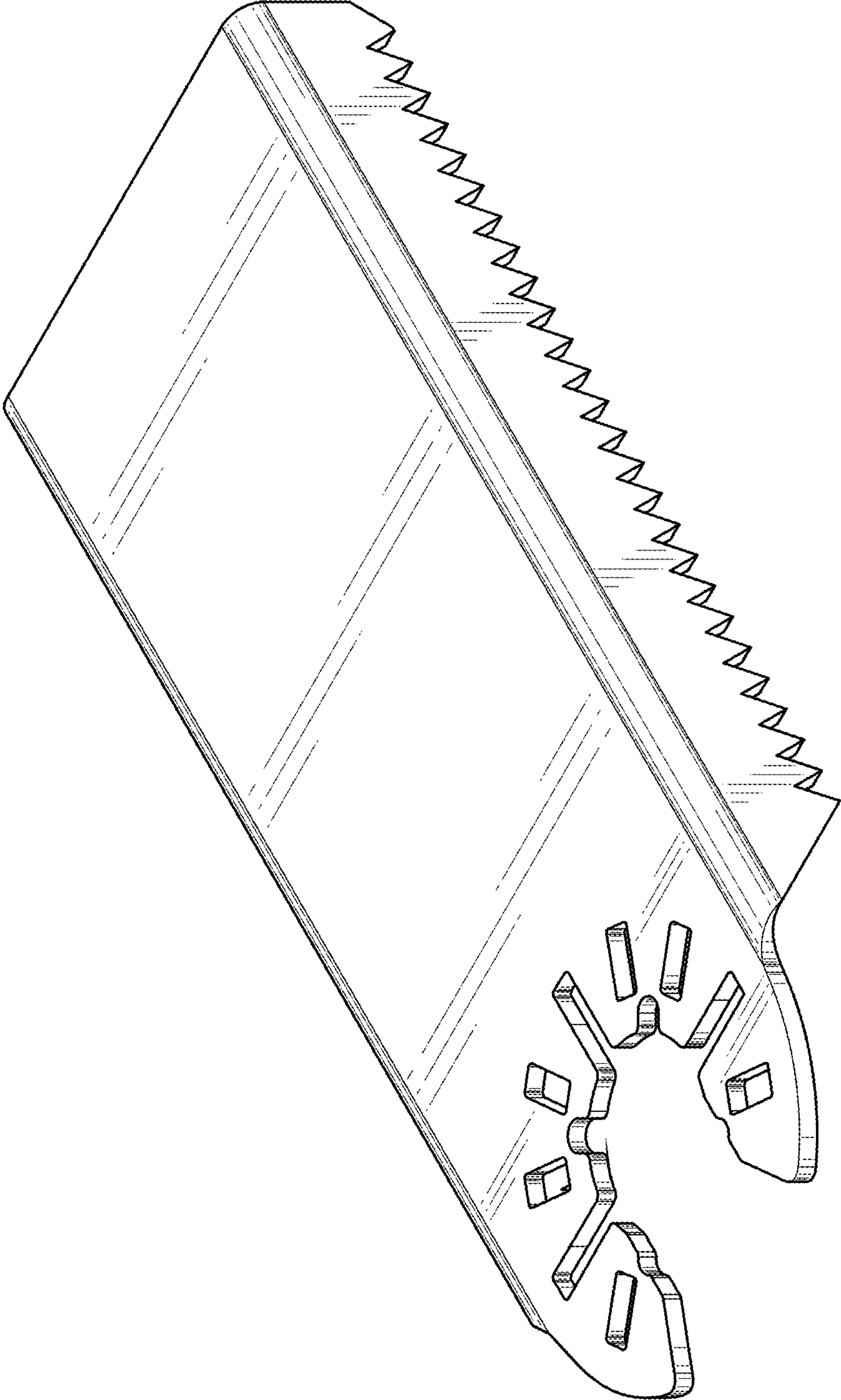

Fig. 1

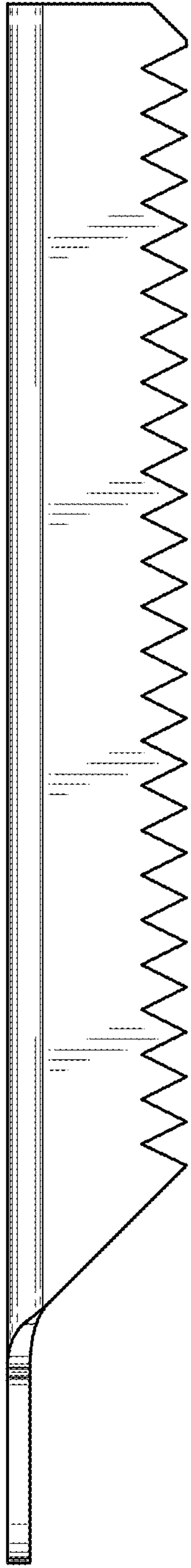

Fig. 2

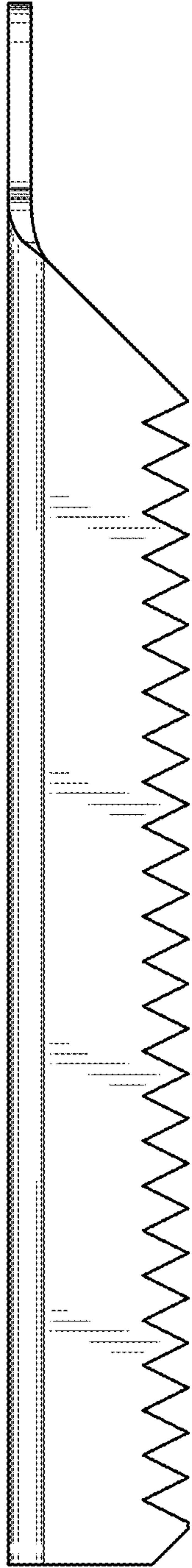

Fig. 3

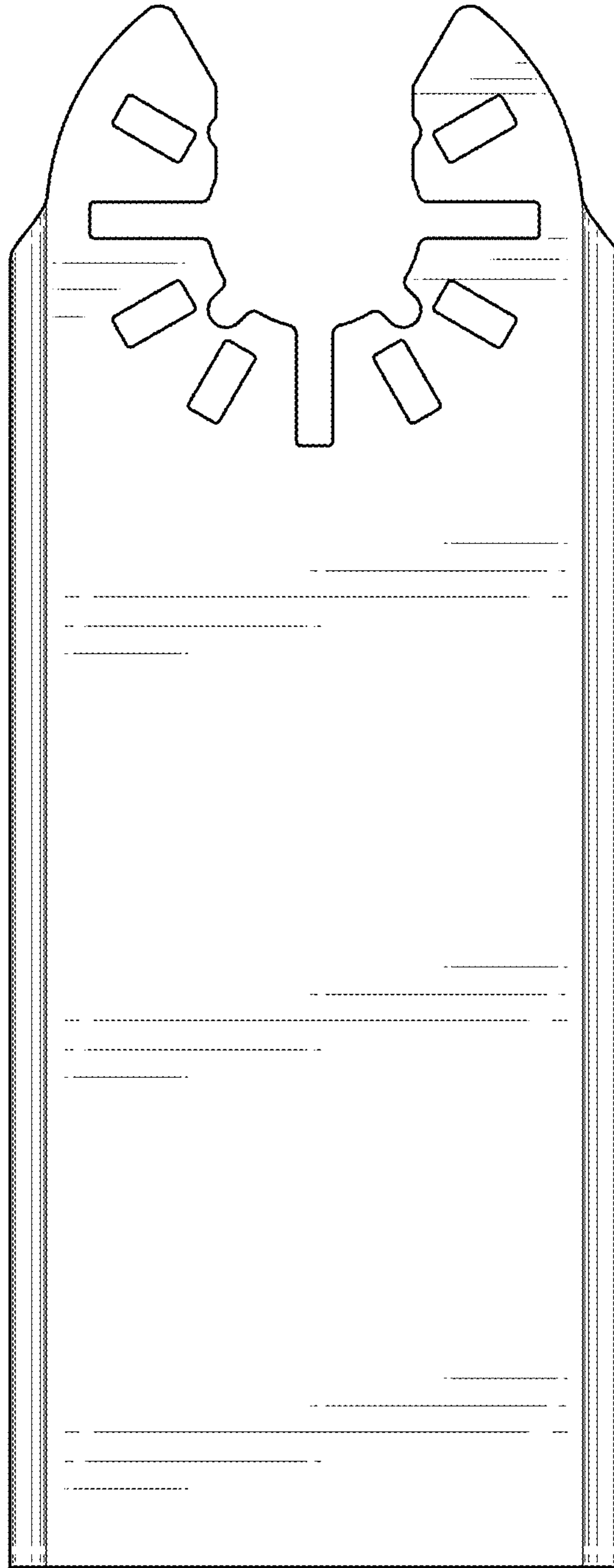

Fig. 4



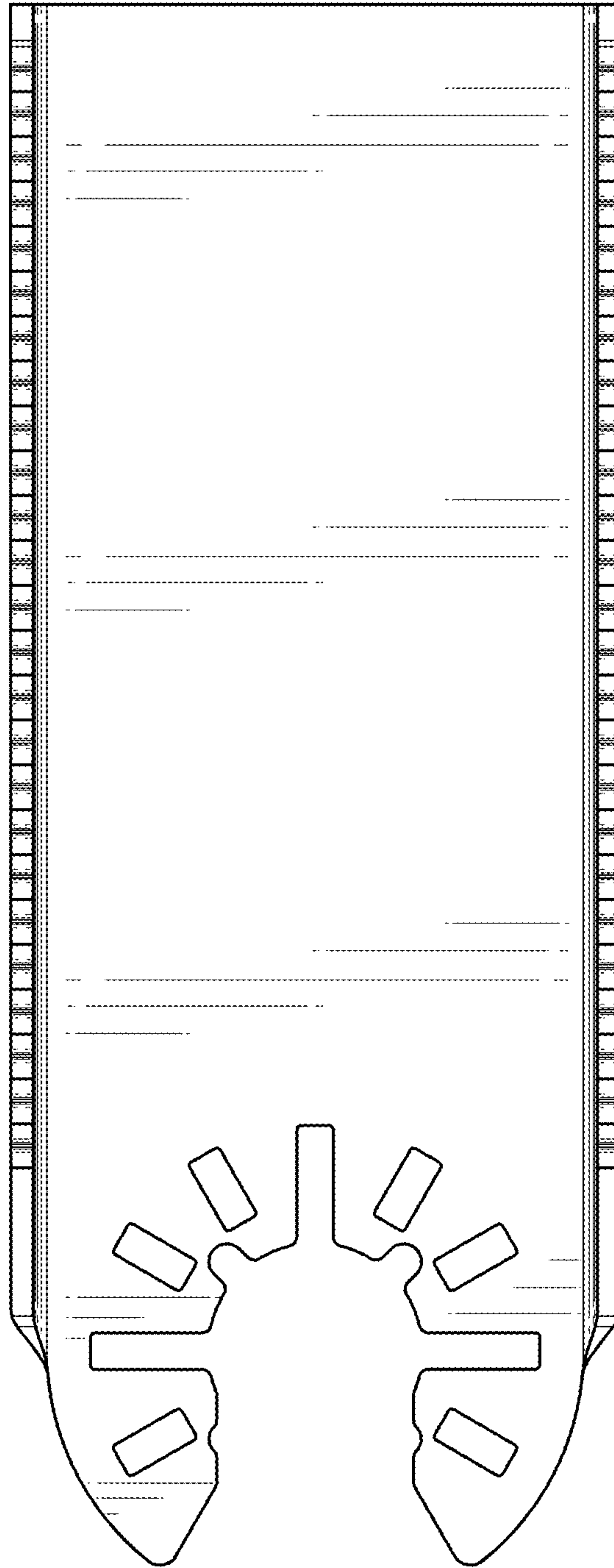

Fig. 5

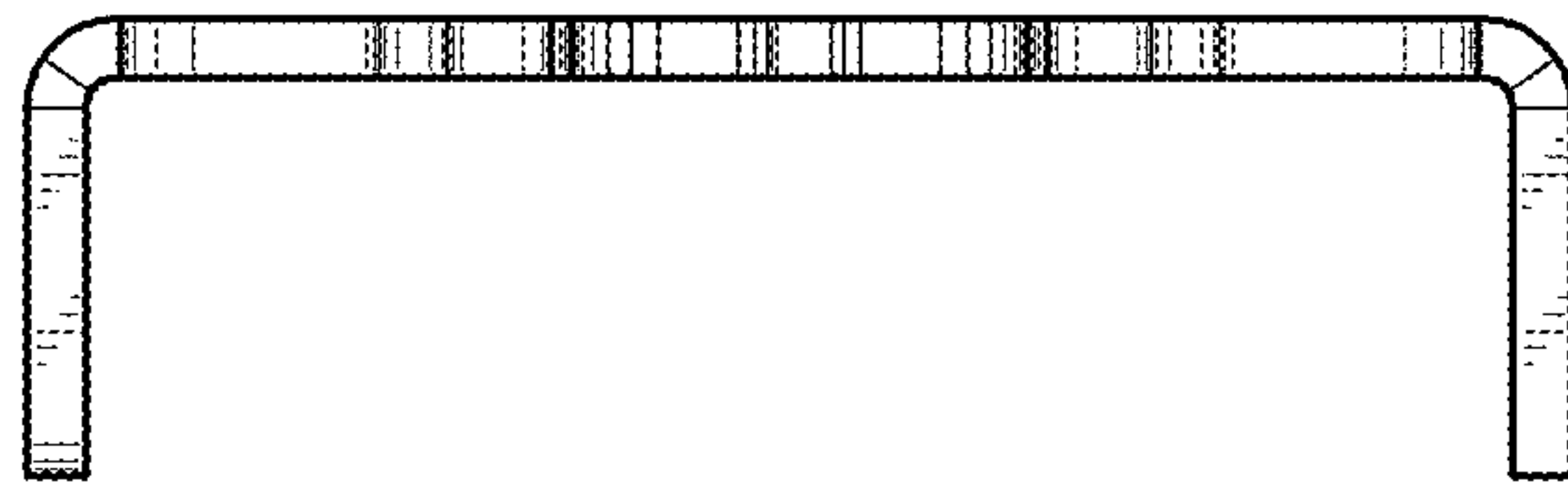

Fig. 6

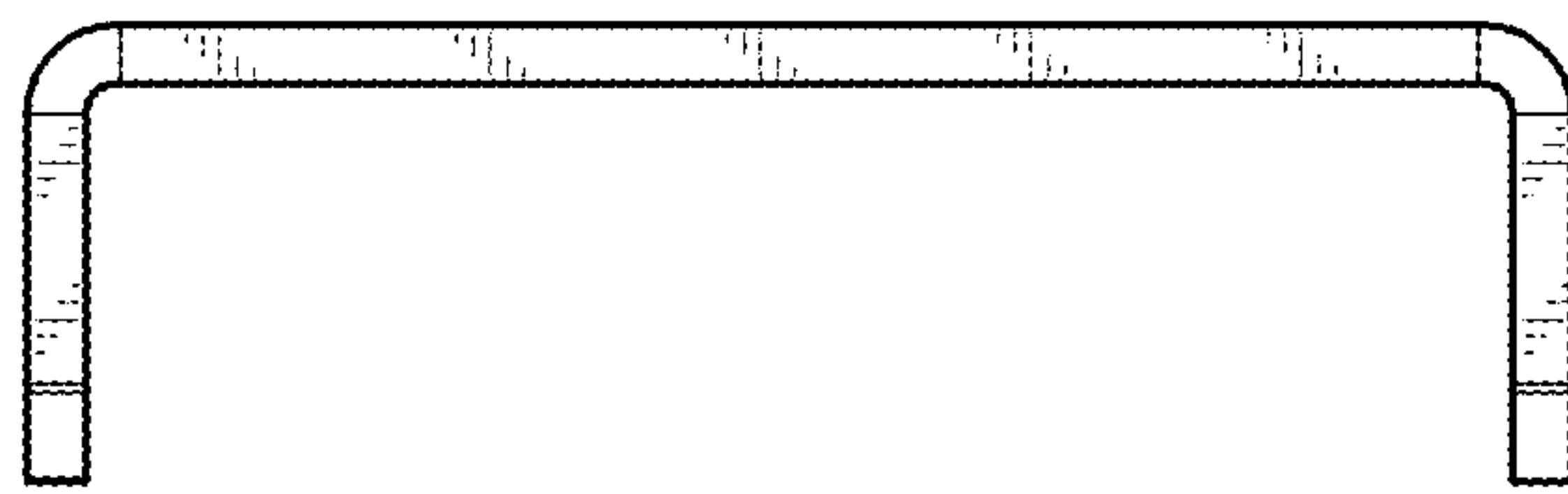

Fig. 7