



US00D856759S

(12) **United States Design Patent** (10) **Patent No.:** **US D856,759 S**
Ahn (45) **Date of Patent:** **** Aug. 20, 2019**

- (54) **HANDLE FOR TUMBLERS**
- (71) Applicant: **SPIGEN KOREA CO., LTD.**, Seoul (KR)
- (72) Inventor: **Deok Hyun Ahn**, Seoul (KR)
- (73) Assignee: **SPIGEN KOREA CO., LTD.**, Seoul (KR)
- (**) Term: **15 Years**
- (21) Appl. No.: **29/630,800**
- (22) Filed: **Dec. 22, 2017**
- (51) **LOC (12) Cl.** **07-06**
- (52) **U.S. Cl.**
USPC **D7/622**
- (58) **Field of Classification Search**
USPC D7/619.1-625, 701-708, 533, 536;
D9/499, 455, 434, 436, 443
CPC ... A45F 5/10; A47G 23/0216; A47G 23/0266;
A47G 23/02; A47G 23/0241; A47G 23/0258; A47J 45/077; A47J 45/10; B65D 2313/02; B65D 23/106; B65D 23/10; B65D 23/104; B65D 23/0233; B65D 23/0241; B65D 23/0216; B65D 25/2829; B65D 25/2817; A45C 11/20
See application file for complete search history.

- 5,655,805 A * 8/1997 Shaddy A47G 23/0216
220/738
- D398,815 S * 9/1998 Hatsumoto D7/533
- 5,816,631 A * 10/1998 Kochan B65D 23/106
294/33
- D437,187 S * 2/2001 Cheng D7/622
- 2015/0041480 A1* 2/2015 Ramsey A47G 23/0266
220/758

OTHER PUBLICATIONS

“Tervis Handle, 16 oz, Black”, <https://www.amazon.com/Tervis-Handle-16-oz-Black/dp/B0067MY6X2>, Earliest review date of Aug. 22, 2010, Downloaded on Mar. 13, 2019.
 “Thermik Handle for YETI Rambler 30 oz Tumblers, Ozark Trail and More”, <https://www.amazon.com/Thermik-Handle-Rambler-Tumblers-Ozark/dp/B01A7VKQD2>, Earliest review date of Feb. 11, 2016, Downloaded on Mar. 13, 2019.

(Continued)

Primary Examiner — Terry A Wallace

(74) *Attorney, Agent, or Firm* — Heedong Chae; Lucem, PC

(57) **CLAIM**

The ornamental design for a handle for tumblers, as shown and described.

DESCRIPTION

FIG. 1 is a front perspective view of a handle for tumblers showing my new design;
 FIG. 2 is a rear perspective view thereof;
 FIG. 3 is a front elevational view thereof;
 FIG. 4 is a rear elevational view thereof;
 FIG. 5 is a left side elevational view thereof;
 FIG. 6 is a right side elevational view thereof;
 FIG. 7 is a top plan view thereof; and,
 FIG. 8 is a bottom plan view thereof.

1 Claim, 8 Drawing Sheets

(56) **References Cited**

U.S. PATENT DOCUMENTS

- 2,378,867 A * 6/1945 Reichart A47J 45/077
220/758
- 3,107,029 A * 10/1963 Rylander A47G 23/0266
215/396
- D370,384 S * 6/1996 Shamis D7/393

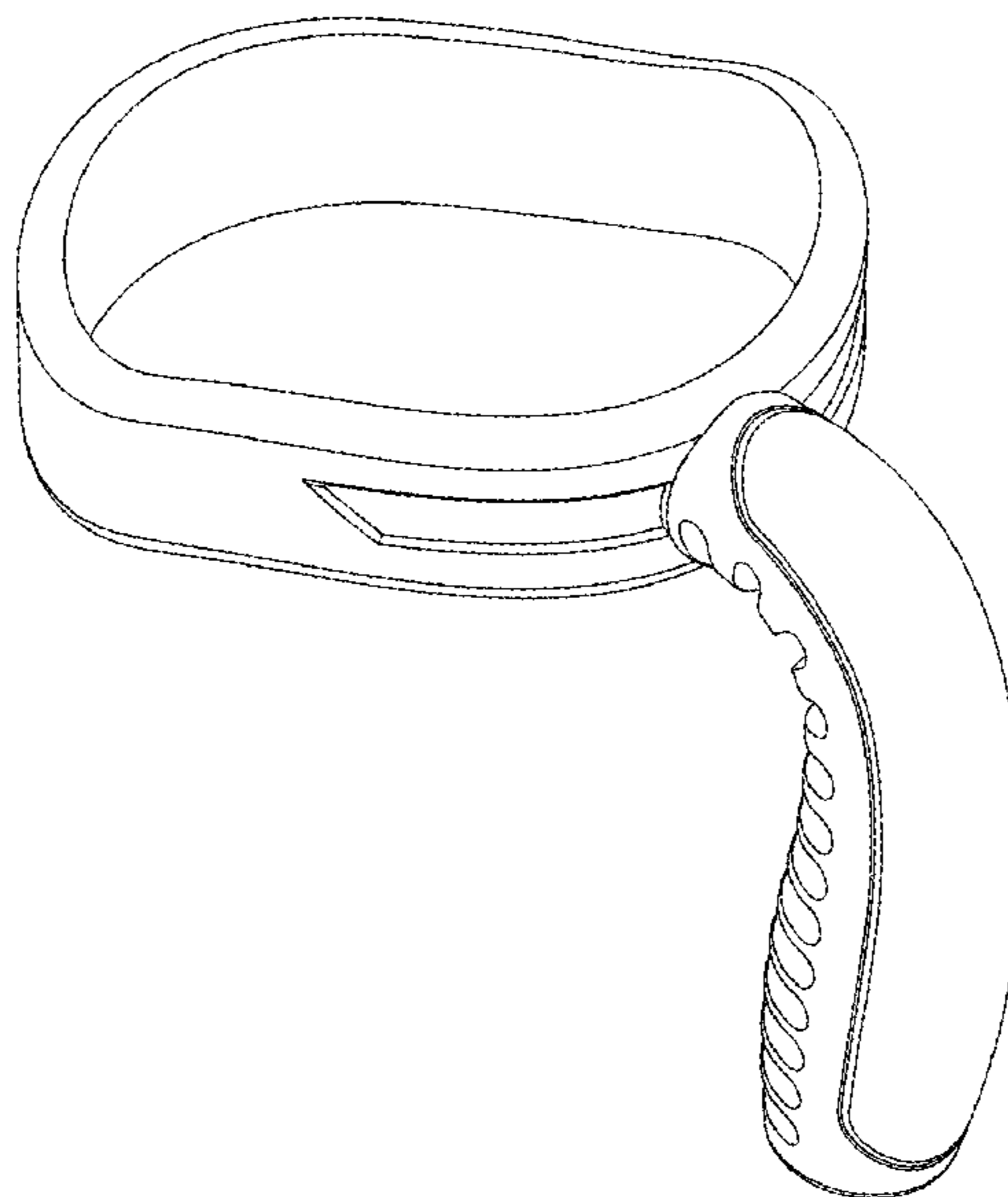

(56)

References Cited

OTHER PUBLICATIONS

“Klaw Grip Handle for YETI 20 oz Rambler, RTIC and Other Stainless Steel 20oz Tumblers (2 Pack)”, <https://www.amazon.com/Grip-Handle-Rambler-Stainless-Tumblers/dp/B01DJLPUOC>, Earliest review date of May 4, 2016, Downloaded on Mar. 13, 2019.

“Greens Steel Beast Handle for 20oz Tumblers Rambler Cup—Black”, <https://www.amazon.com/Greens-Steel-Handle-Tumblers-Rambler/dp/B01LYBJROW>, Earliest review date of Jul. 12, 2016, Downloaded on Mar. 13, 2019.

“GLACIO Handle for Rambler 20 oz Tumblers, Black”, <https://www.amazon.com/GLACIO-Handle-Rambler-Tumblers-Black/dp/B01HX1SC44>, Earliest review date of Jul. 16, 2016, Downloaded on Mar. 13, 2019.

“Handle for YETI Rambler Tumbler, Ozark Trail, RTIC and Many More—Available in 30oz and 20oz | YETI Cup Handle (30oz, Blue)”, <https://www.amazon.com/Handle-Rambler-Tumbler-Ozark-Trail/dp/B01K4XXRIO>, Earliest review date of Jul. 26, 2016, Downloaded on Mar. 13, 2019.

“Tumbler Handle for 20 oz YETI Rambler Cooler Cup, Rtic Mug, Sic, Ozark Trail Grip and more (20 Oz, Black)”, <https://www.amazon.com/Tumbler-Handle-Rambler-Cooler-Ozark/dp/B01I90QJZM>, Earliest review date of Jul. 31, 2016, Downloaded on Mar. 13, 2019.

“Purple Handle for YETI Cup 30 oz—Ozark Trail—Simple Modern—Atlin & Other 30 oz Tumblers. Chillout Life Comfortable Handle for 30 oz Tumbler BPA-Free (Purple Handle Only)”, <https://www.amazon.com/Purple-Handle-YETI-Cup-Comfortable/dp/B01KEJNWBA>, Earliest review date of Aug. 5, 2016, Downloaded on Mar. 13, 2019.

“Thermik Handle for Yeti Rambler 20 oz Tumblers, Ozark Trail and More (Black)”, <https://www.amazon.com/Thermik-Handle-Rambler-Tumblers-Ozark/dp/B01CT867NY>, Earliest review date of Aug. 13, 2016, Downloaded on Mar. 13, 2019.

“The Original YUMI Handle Perfectly Fits All Major Brand 30 Ounce Yeti Type Tumblers. Exclusive Scandinavian Design. (Tumbler Not Included)”, <https://www.amazon.com/Original-Perfectly->

Tumblers-Exclusive-Scandinavian/dp/B01BMB5NSE, Earliest review date of Aug. 19, 2016, Downloaded on Mar. 13, 2019.

“YETI Rambler Tumbler”, <https://www.amazon.com/YETI-Rambler-Tumbler/dp/B01JQ7ED4Q>, Earliest review date of Aug. 29, 2016, Downloaded on Mar. 13, 2019.

“MdSiY Yeti Tumbler Handle 30 oz—Fits Ozark, Yeti Rambler, RTIC and other 30 oz tumblers—FDA-approved and BPA-free material (Blue)”, <https://www.amazon.com/MdSiY-Yeti-Tumbler-Handle-FDA-approved/dp/B01NA8QYKZ>, Earliest review date of Sep. 18, 2016, Downloaded on Mar. 13, 2019.

“EVERIE Tumbler Handle 30 Oz for Yeti, Ozark Trail Tumblers (30 Oz, Black)”, <https://www.amazon.com/EVERIE-Tumbler-Handle-Ozark-Tumblers/dp/B01M7ONSBV>, Earliest review date of Nov. 10, 2016, Downloaded on Mar. 13, 2019.

“EVERIE Tumbler Handle for Yeti, Ozark Trail 30 Oz Tumblers (30 Oz, Black)”, <https://www.amazon.com/EVERIE-Tumbler-Handle-Ozark-Tumblers/dp/B01M67CKCK>, Earliest review date of Nov. 24, 2016, Downloaded on Mar. 13, 2019.

“Liquid Savvy 30oz Stainless Steel Tumbler Bundle—Includes Tumbler, 2 Lids, Straw, and Handle—Double Walled Vacuum Insulated Tumbler for Hot and Cold Beverages—Stainless Steel”, <https://www.amazon.com/Liquid-Savvy-Stainless-Tumbler-Bundle/dp/B01LN2LOR6>, Earliest review date of Dec. 5, 2016, Downloaded on Mar. 13, 2019.

“Simple Modern 30oz Cruiser Tumbler Handle—Use as a Travel Mug Coffee Cup—Tumbler not Included—Lilac Purple”, <https://www.amazon.com/Simple-Modern-Cruiser-Tumbler-Handle/dp/B072JKTW73>, Earliest review date of Sep. 3, 2017, Downloaded on Mar. 13, 2019.

“40oz Grab Life Outdoors Handle for 40 Oz Tumblers—Fits 40 Ounce Ozark Trail, 40 Oz RTIC, 40 Oz Fireki, 40 Oz Simple Modern, 40 Oz Pure & More—Handle Only (Black)”, <https://www.amazon.com/Grab-Life-Outdoors-Handle-Tumblers/dp/B073YFPKL7>, Earliest review date of Sep. 30, 2017, Downloaded on Mar. 13, 2019.

“40oz F-32 Handle—8 COLORS—Fits 40 Oz RTIC tumbler, 40Oz Simple Modern Cup, 40oz Pure, 40oz Fireki and more—Does Not Fit Ozark Trail—BPA Free (40OZ, Zen Gray)”, <https://www.amazon.com/40oz-F-32-Handle-COLORS-tumbler/dp/B074D7CG16>, Earliest review date of Oct. 17, 2017, Downloaded on Mar. 13, 2019.

* cited by examiner

FIG. 1

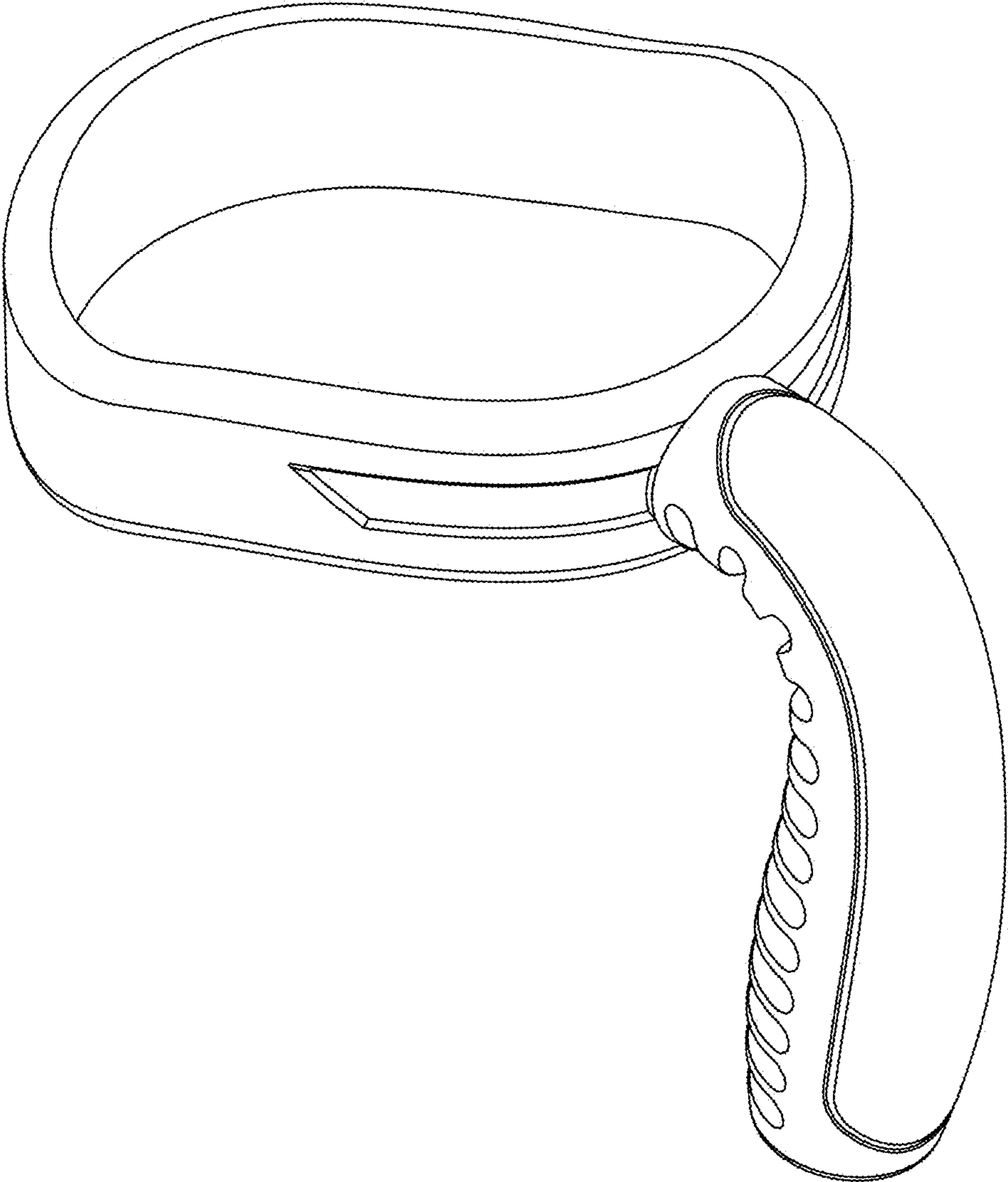

FIG. 2

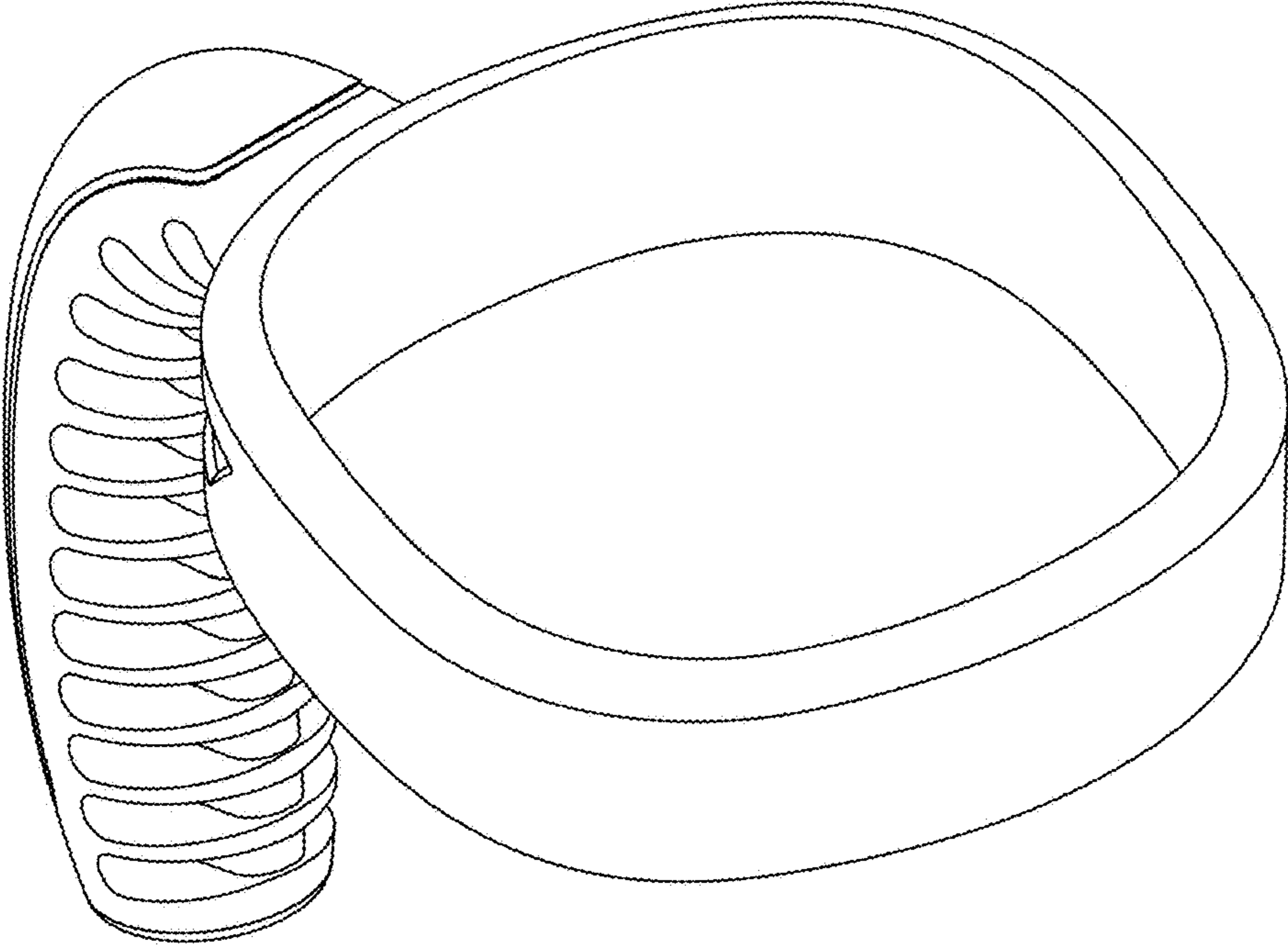

FIG. 3

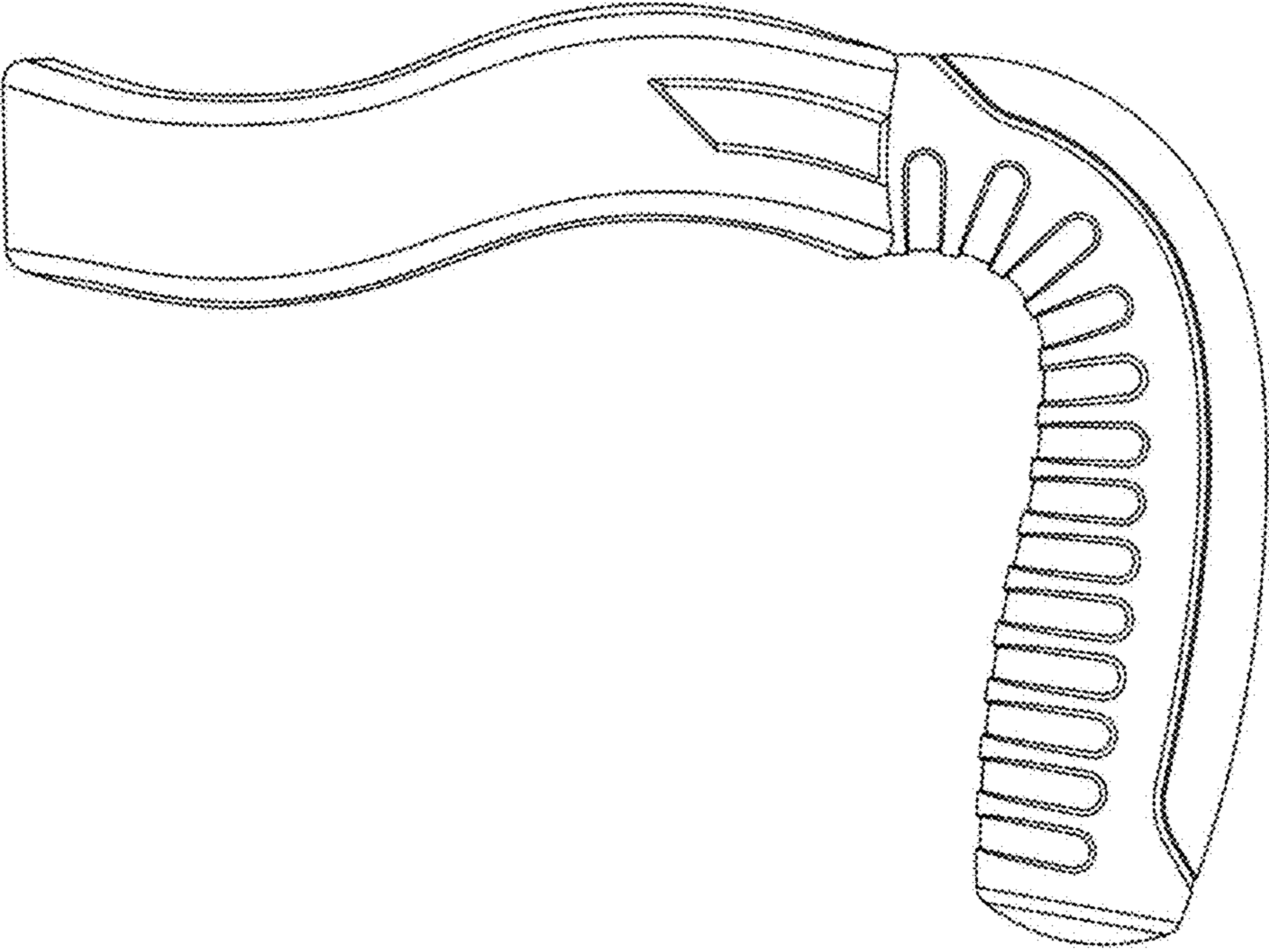

FIG. 4

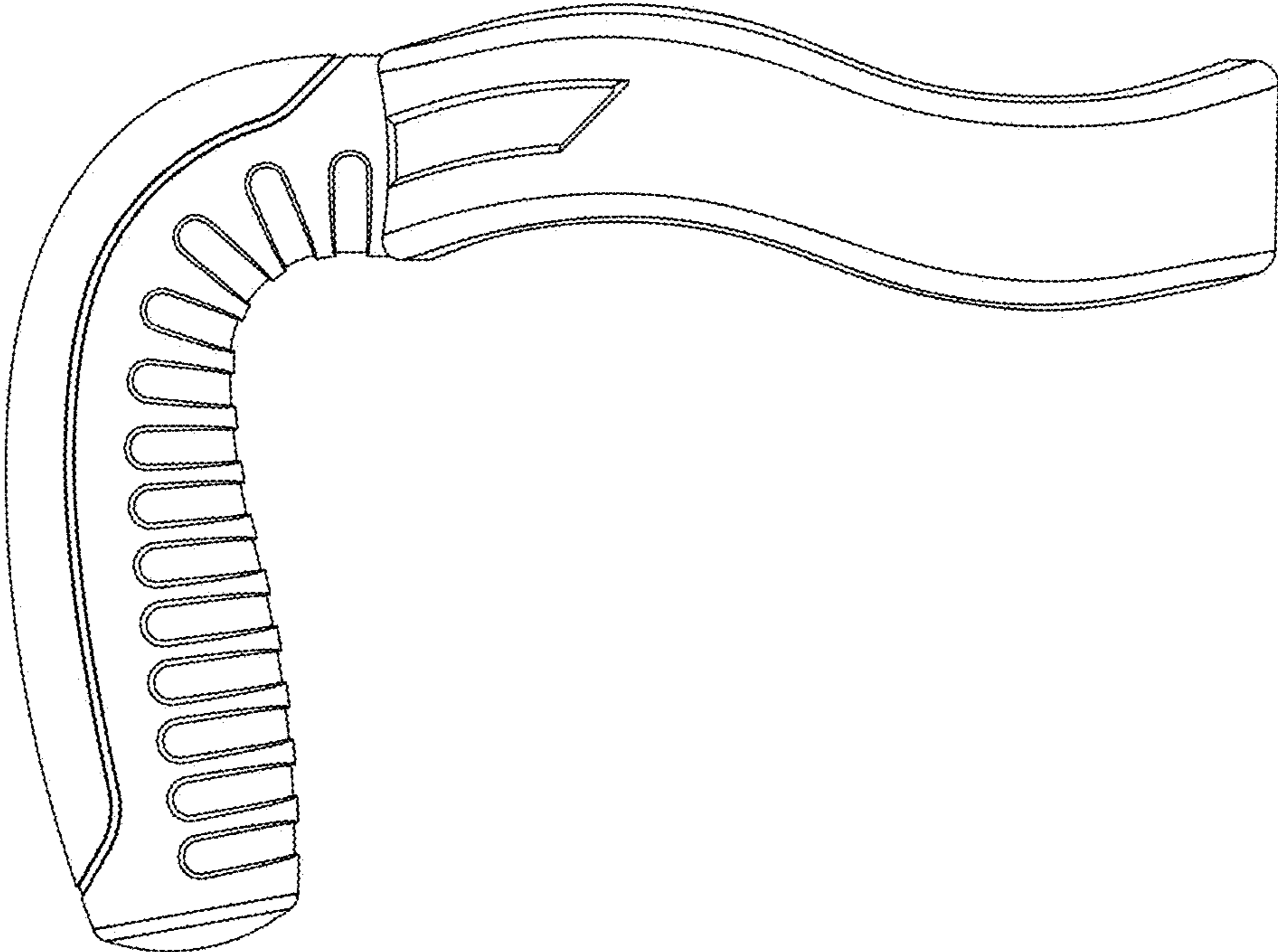

FIG. 5

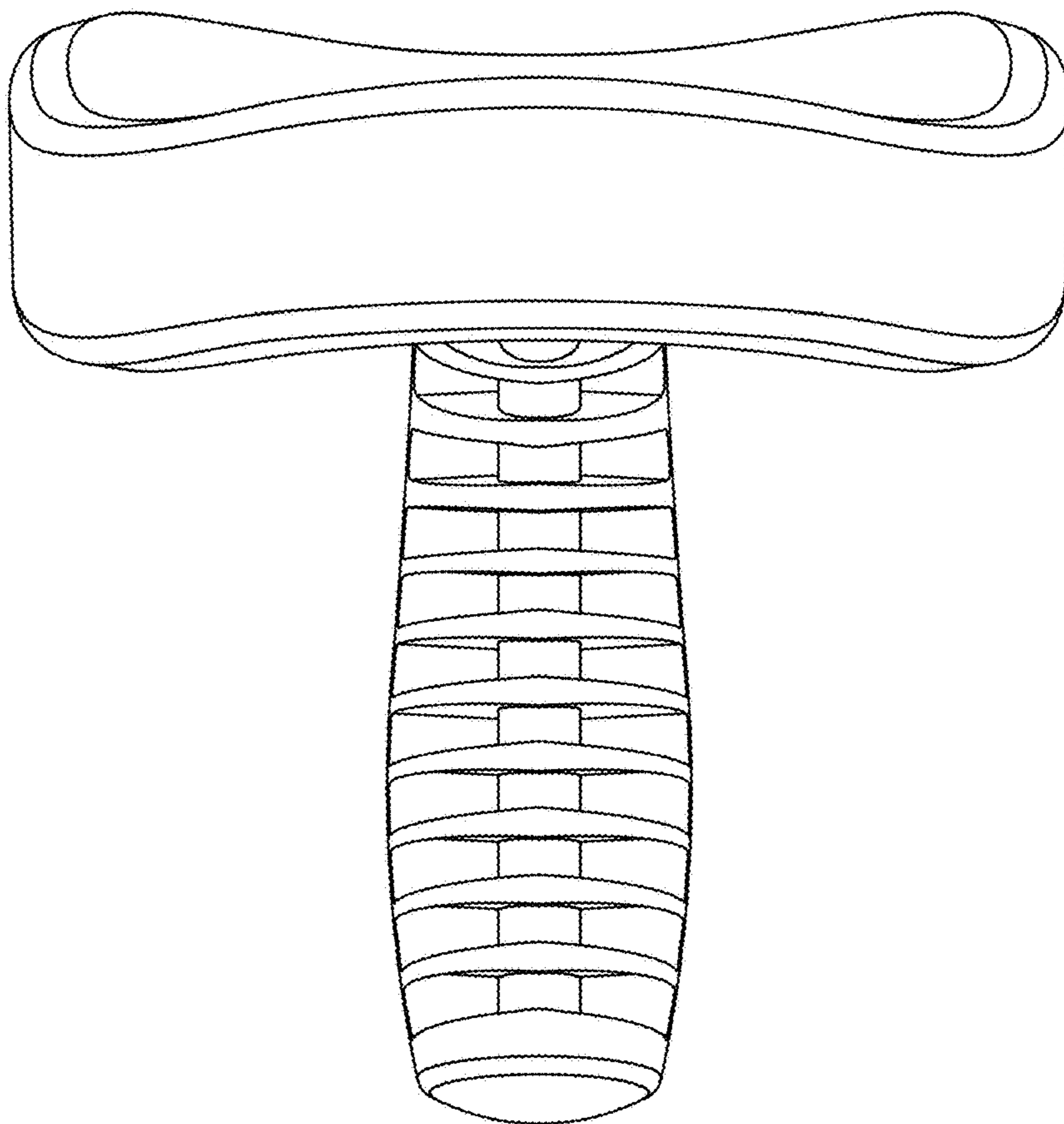

FIG. 6

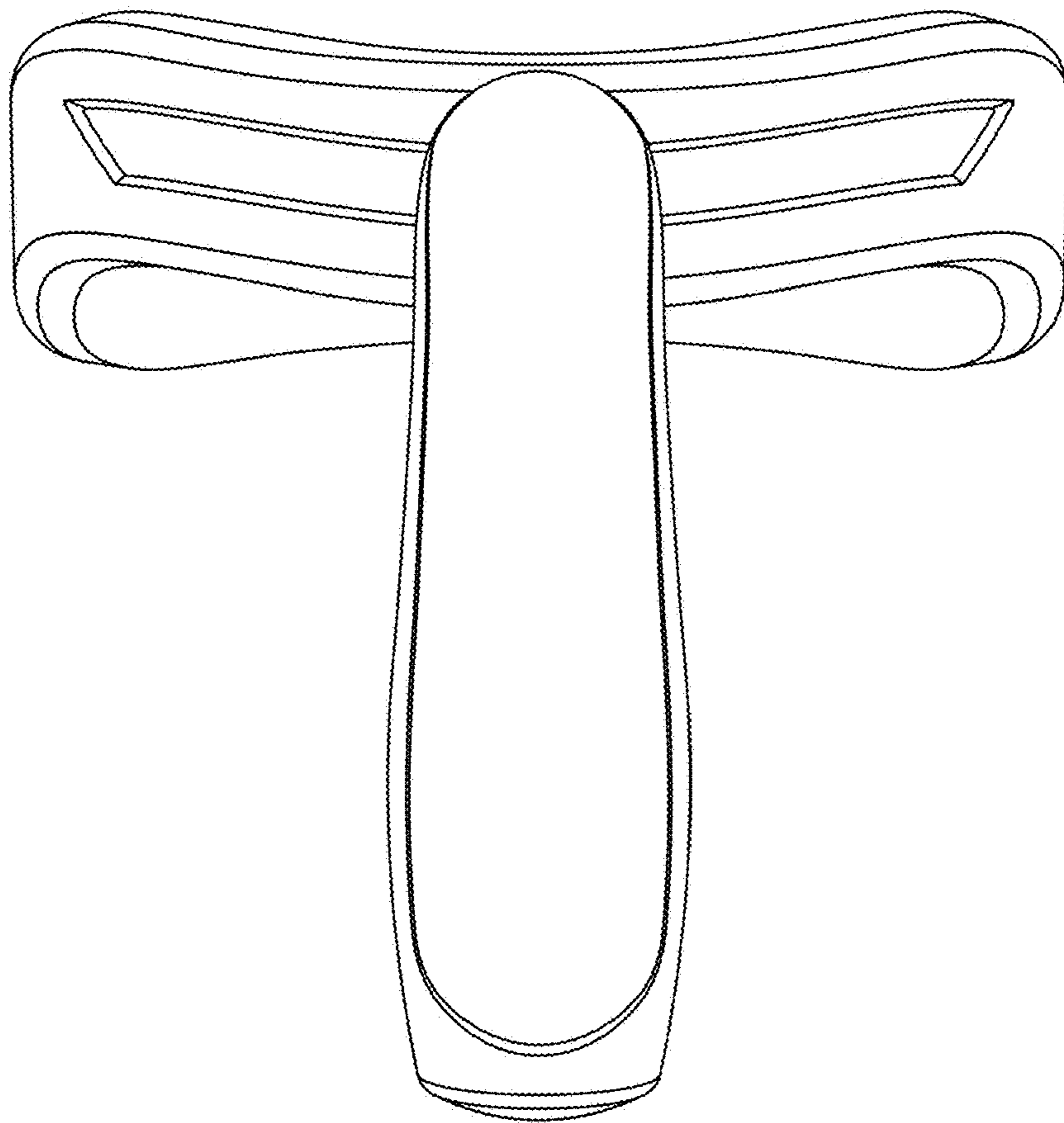

FIG. 7

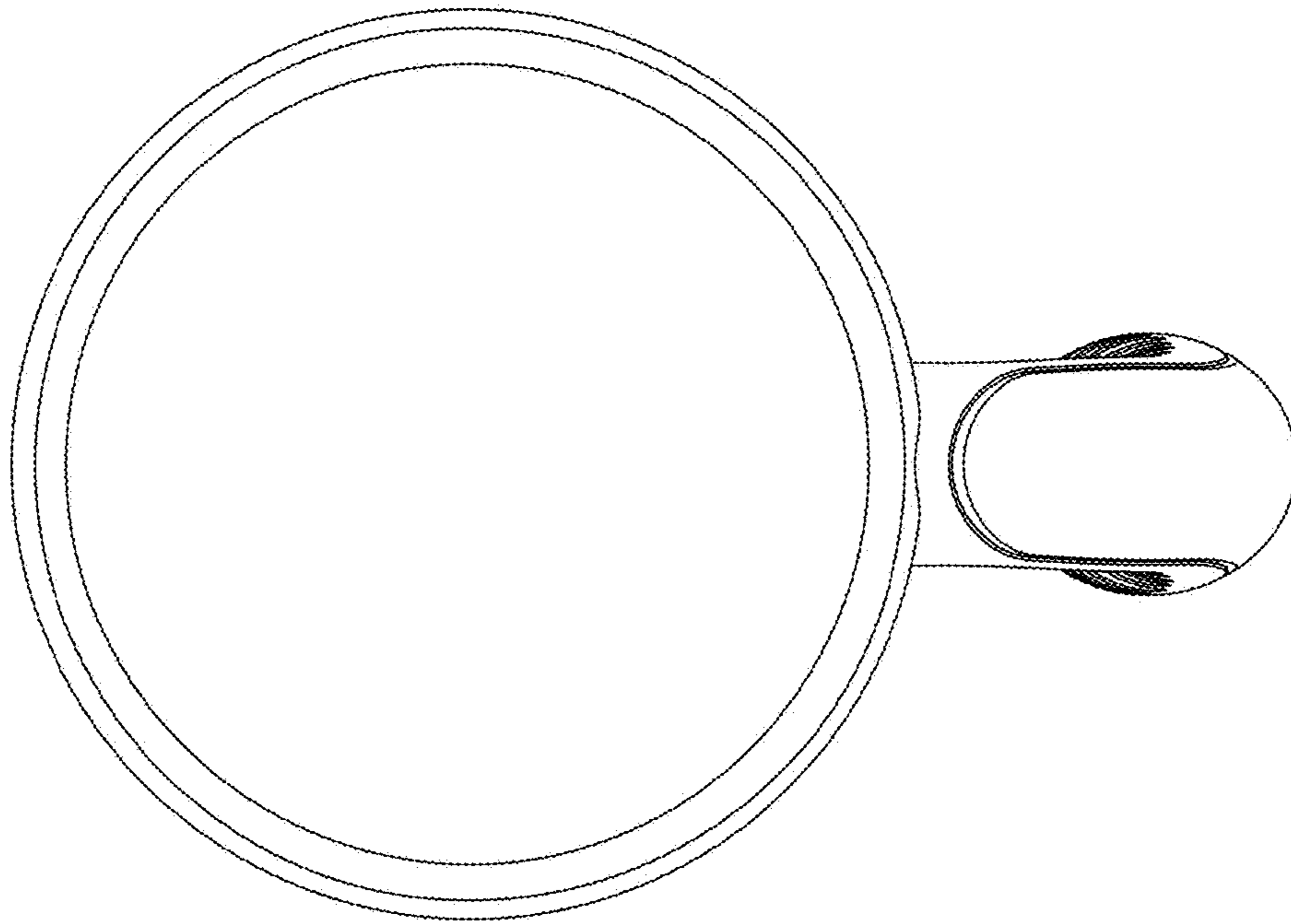

FIG. 8

