



US00D856679S

(12) **United States Design Patent** (10) **Patent No.:** **US D856,679 S**
Stone (45) **Date of Patent:** **** Aug. 20, 2019**

(54) **HANDBAG ORNAMENT**

(71) Applicant: **Sophia Stone**, Palm Beach Gardens, FL (US)

(72) Inventor: **Sophia Stone**, Palm Beach Gardens, FL (US)

(**) Term: **15 Years**

(21) Appl. No.: **29/635,326**

(22) Filed: **Jan. 30, 2018**

(51) **LOC (12) Cl.** **03-01**

(52) **U.S. Cl.**
USPC **D3/318**

(58) **Field of Classification Search**
USPC D3/318; D11/7, 17, 22
(Continued)

(56) **References Cited**

U.S. PATENT DOCUMENTS

D175,612 S * 9/1955 Katz D11/18
D223,273 S * 4/1972 Ochs D10/30
(Continued)

Primary Examiner — Holly H Baynham

(74) *Attorney, Agent, or Firm* — Ingram IP Law, P.A.

(57) **CLAIM**

I claim the ornamental design for an handbag ornament, as shown and described.

DESCRIPTION

FIG. 1 is a perspective view of an handbag ornament showing my new design;
FIG. 2 is a front view thereof;
FIG. 3 is a rear view thereof;
FIG. 4 is a right side view thereof;
FIG. 5 is a left side view thereof;
FIG. 6 is a top view thereof;
FIG. 7 is a bottom view thereof;

FIG. 8 is a front view thereof with a fastening plate coupled thereto;

FIG. 9 is a top view thereof with a fastening plate coupled thereto;

FIG. 10 is a right side view thereof with a fastening plate coupled thereto; and

FIG. 11 is a perspective view of the handbag ornament illustrating my new design in the environment of a handbag.

FIG. 12 is a perspective view of a second embodiment of the handbag ornament showing my new design;

FIG. 13 is a front view of the second embodiment thereof;

FIG. 14 is a rear view of the second embodiment thereof;

FIG. 15 is a right side view of the second embodiment thereof;

FIG. 16 is a left side view of the second embodiment thereof;

FIG. 17 is a top view of the second embodiment thereof;

FIG. 18 is a bottom view of the second embodiment thereof;

FIG. 19 is a front view of the second embodiment thereof with a fastening plate coupled thereto;

FIG. 20 is a top view of the second embodiment thereof with a fastening plate coupled thereto;

FIG. 21 is a right side view of the second embodiment thereof with a fastening plate coupled thereto; and

FIG. 22 is a perspective view of the second embodiment of the handbag ornament illustrating my new design in the environment of a handbag.

FIG. 23 is a perspective view of a third embodiment of the handbag ornament showing my new design;

FIG. 24 is a front view of the third embodiment thereof;

FIG. 25 is a rear view of the third embodiment thereof;

FIG. 26 is a right side view of the third embodiment thereof;

FIG. 27 is a left side view of the third embodiment thereof;

FIG. 28 is a top view of the third embodiment thereof;

FIG. 29 is a bottom view of the third embodiment thereof;

FIG. 30 is a front view of the third embodiment thereof with a fastening plate coupled thereto;

FIG. 31 is a top view of the third embodiment thereof with a fastening plate coupled thereto;

FIG. 32 is a right side view of the third embodiment thereof with a fastening plate coupled thereto; and,

FIG. 33 is a perspective view of the third embodiment of the handbag ornament illustrating my new design in the environment of a handbag.

(Continued)

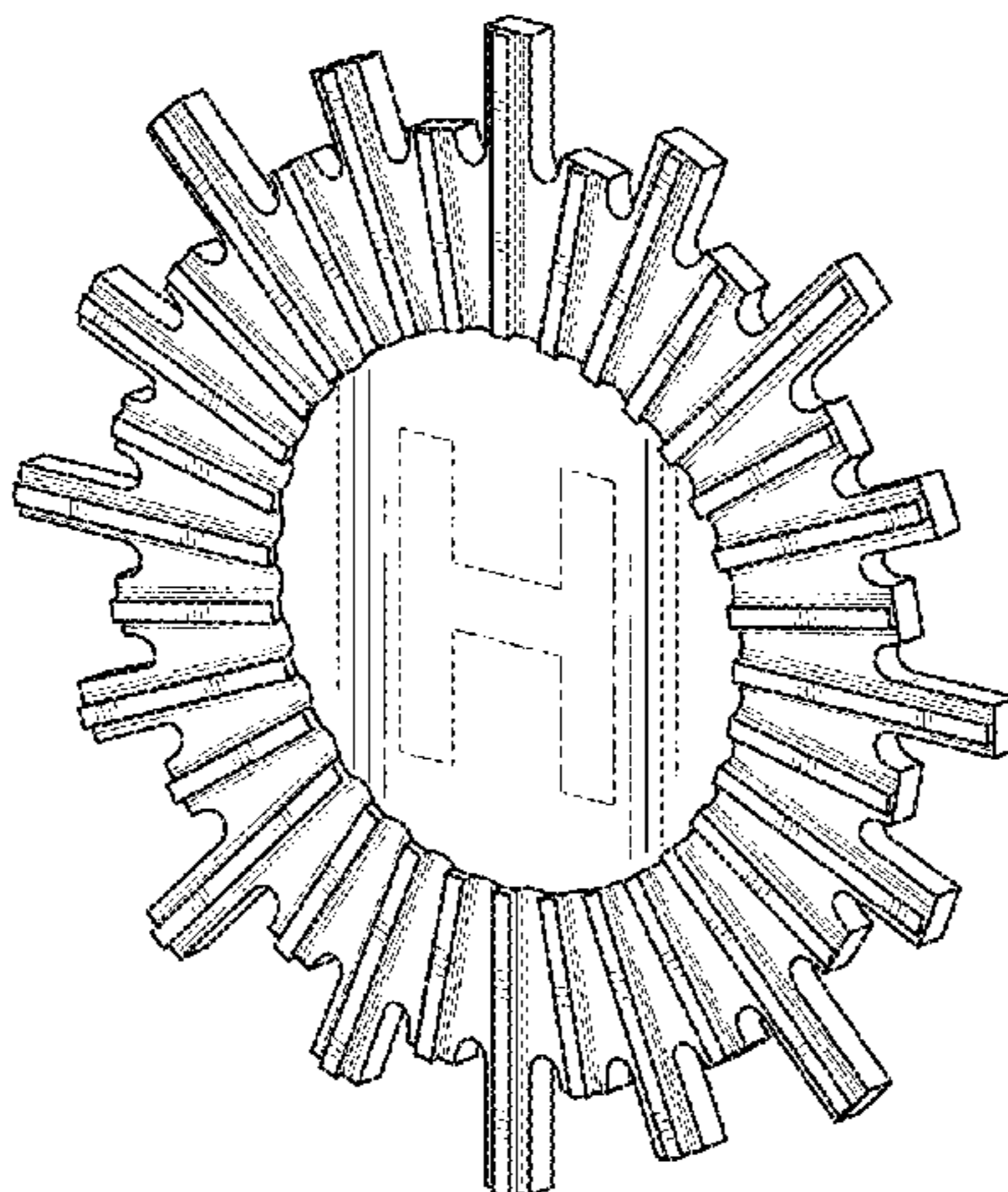

Broken lines are used to illustrate environment and unclaimed portions of the handbag ornament.

Broken lines, and any boundary created thereby, form no part of the claimed design.

1 Claim, 24 Drawing Sheets

(58) **Field of Classification Search**

CPC A45C 11/18; A45C 11/182; A45C 1/02;
A45C 1/04

See application file for complete search history.

(56) **References Cited**

U.S. PATENT DOCUMENTS

D223,274 S *	4/1972	Ochs	D10/30
D793,723 S *	8/2017	Lopez Montoya	D3/232
D798,046 S *	9/2017	Michele	D3/232
D828,021 S *	9/2018	Larian	D3/232

* cited by examiner

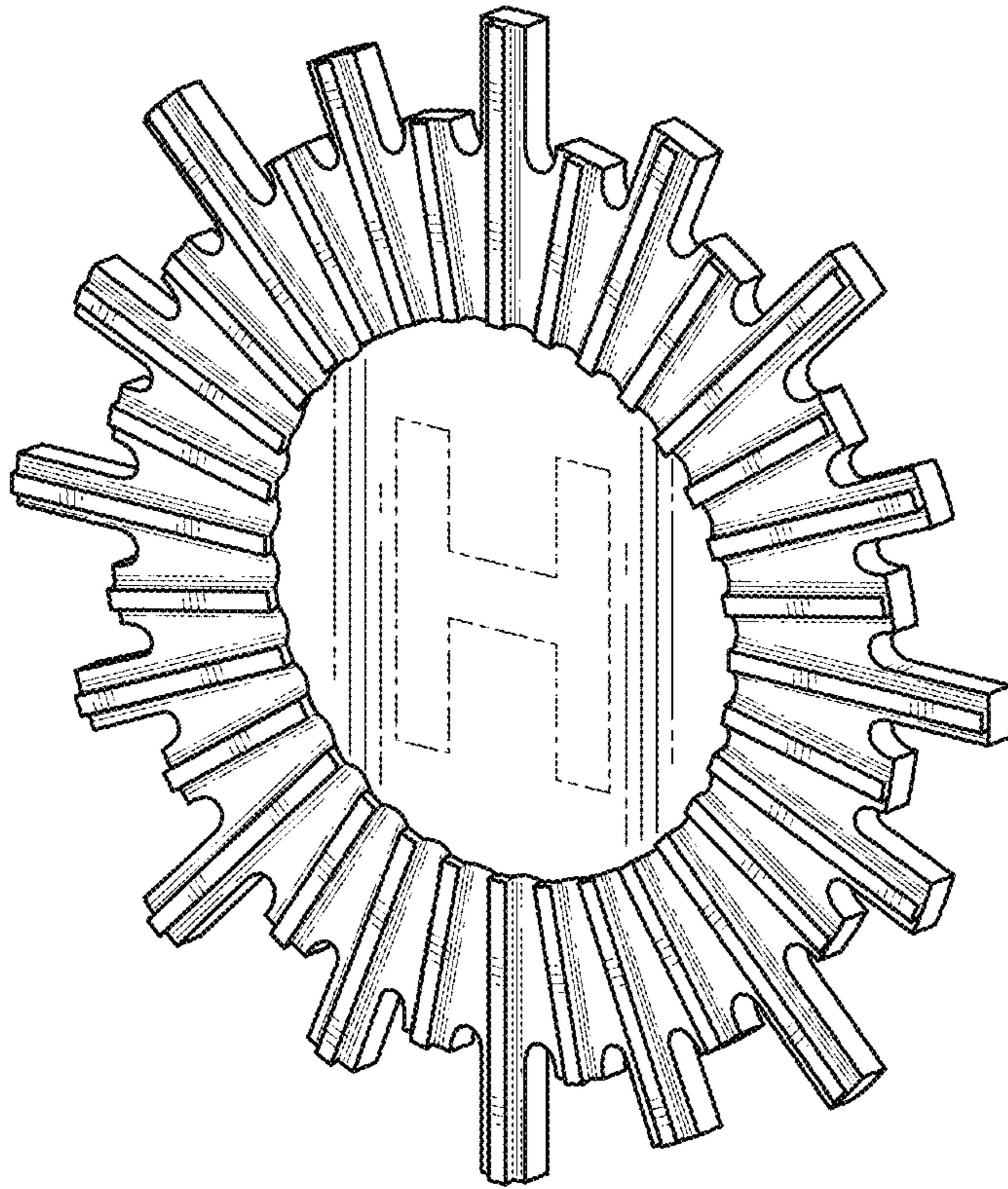

FIG. 1

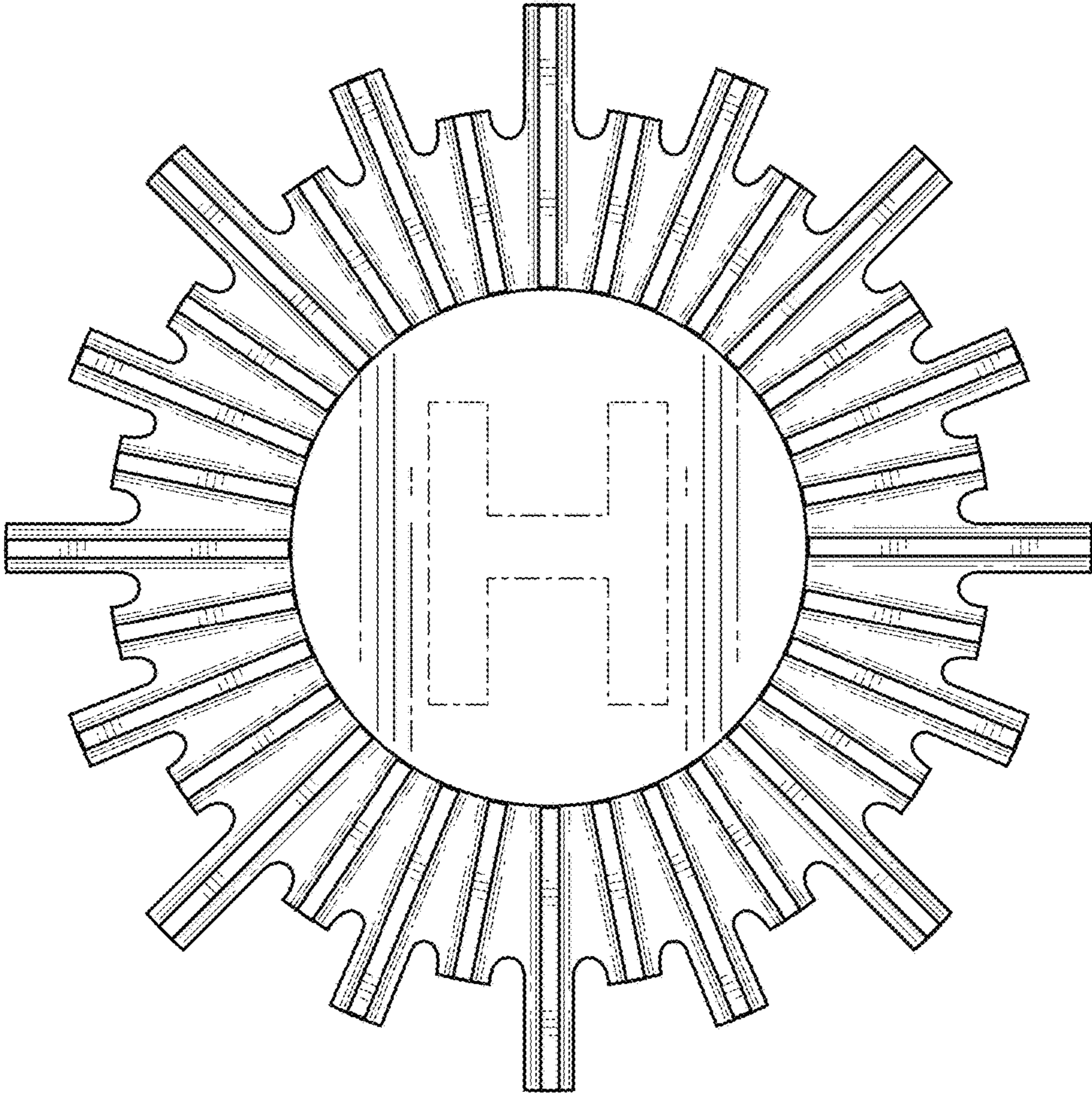

FIG. 2

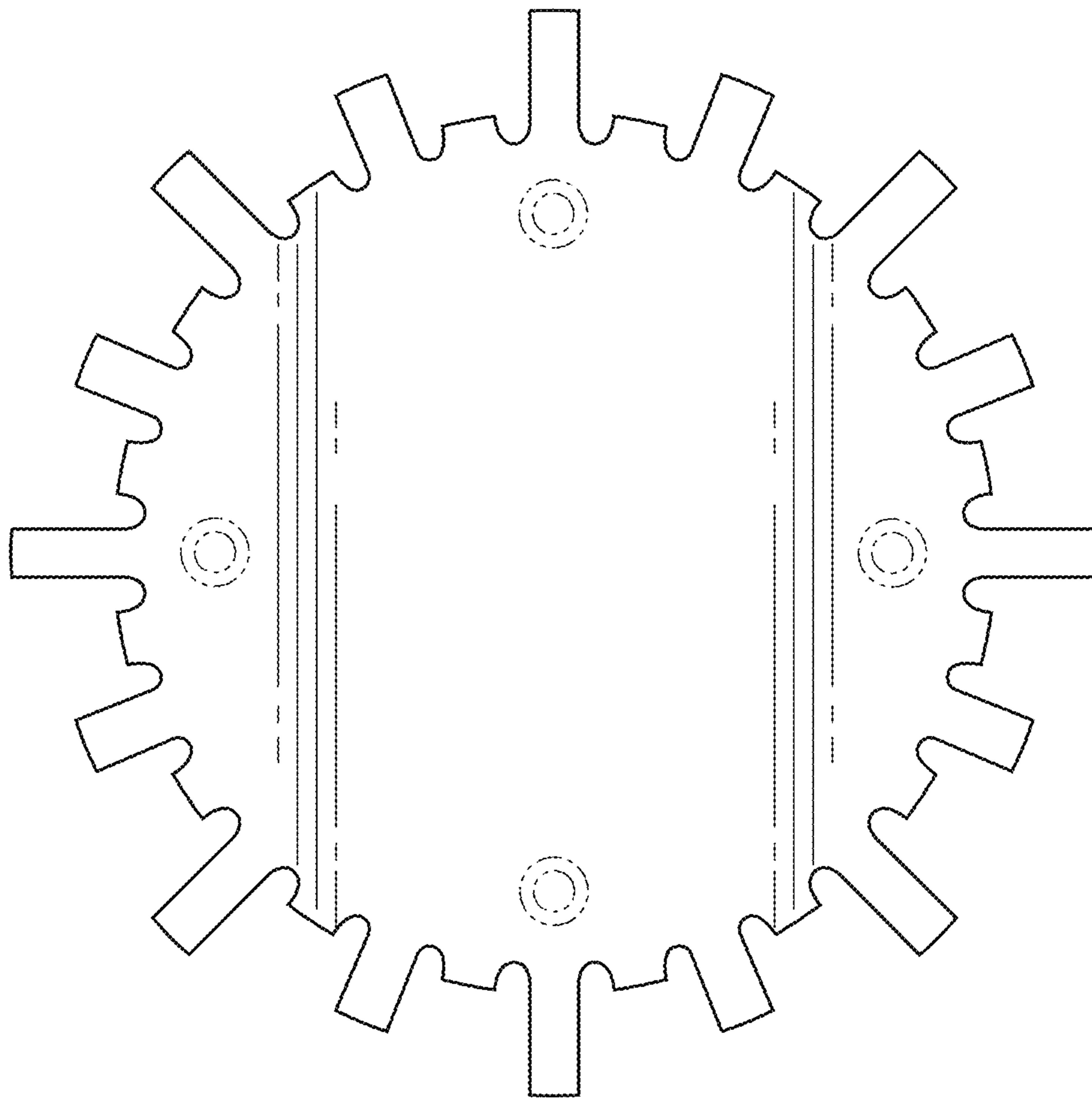

FIG. 3

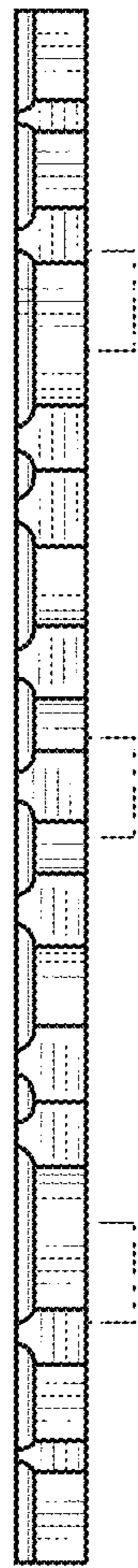

FIG. 4



FIG. 5

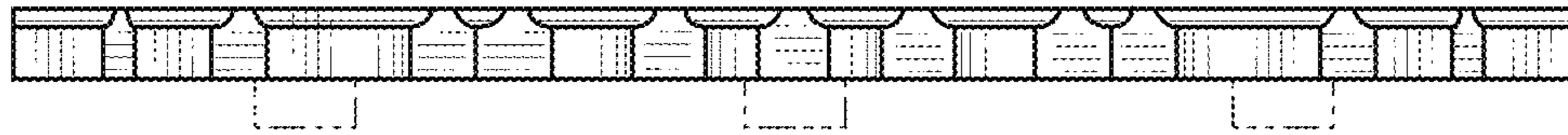

FIG. 6

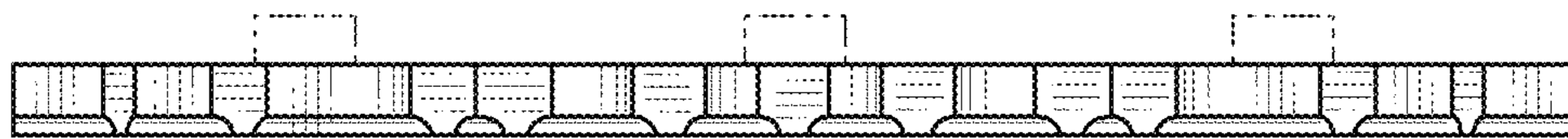

FIG. 7

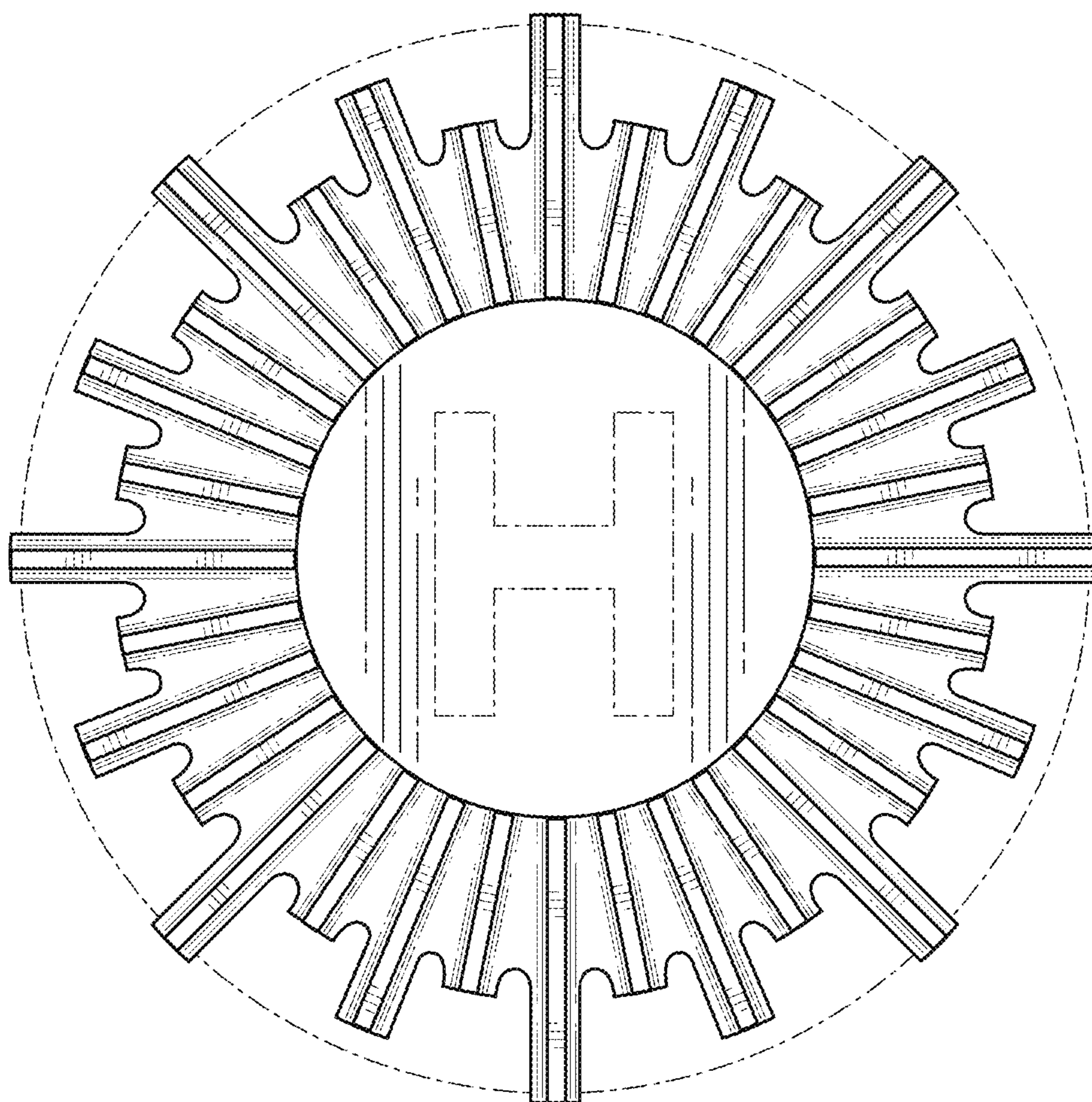

FIG. 8

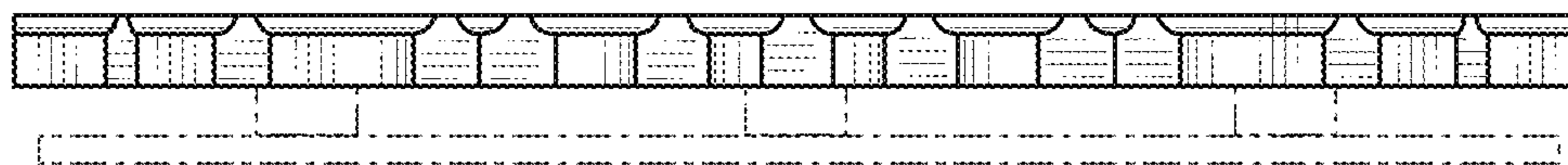

FIG. 9

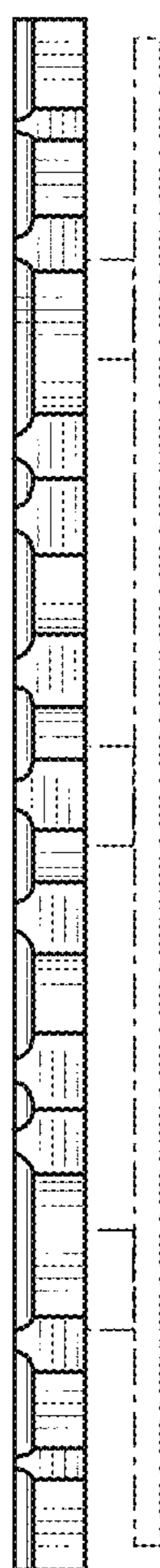

FIG. 10

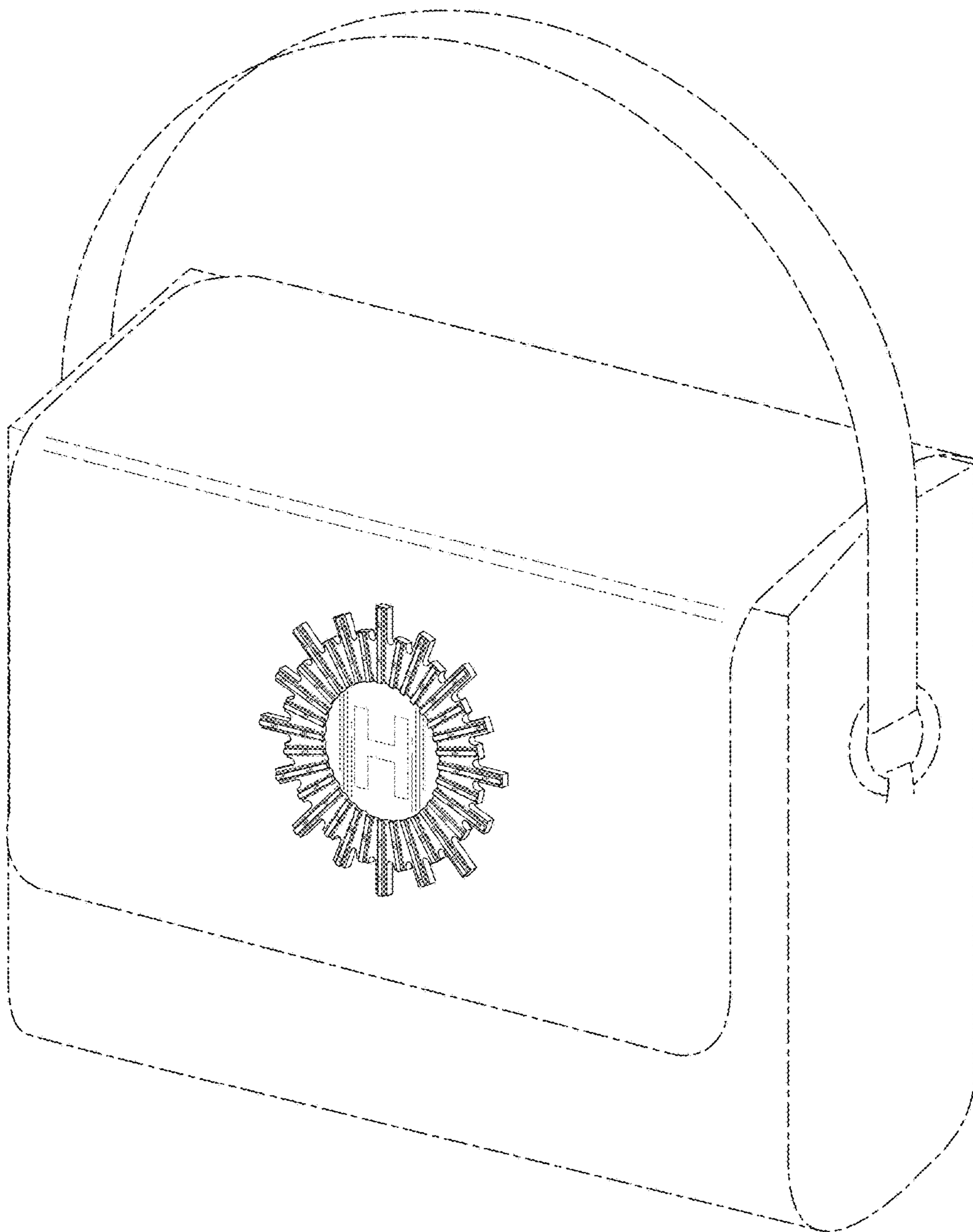

FIG. 11

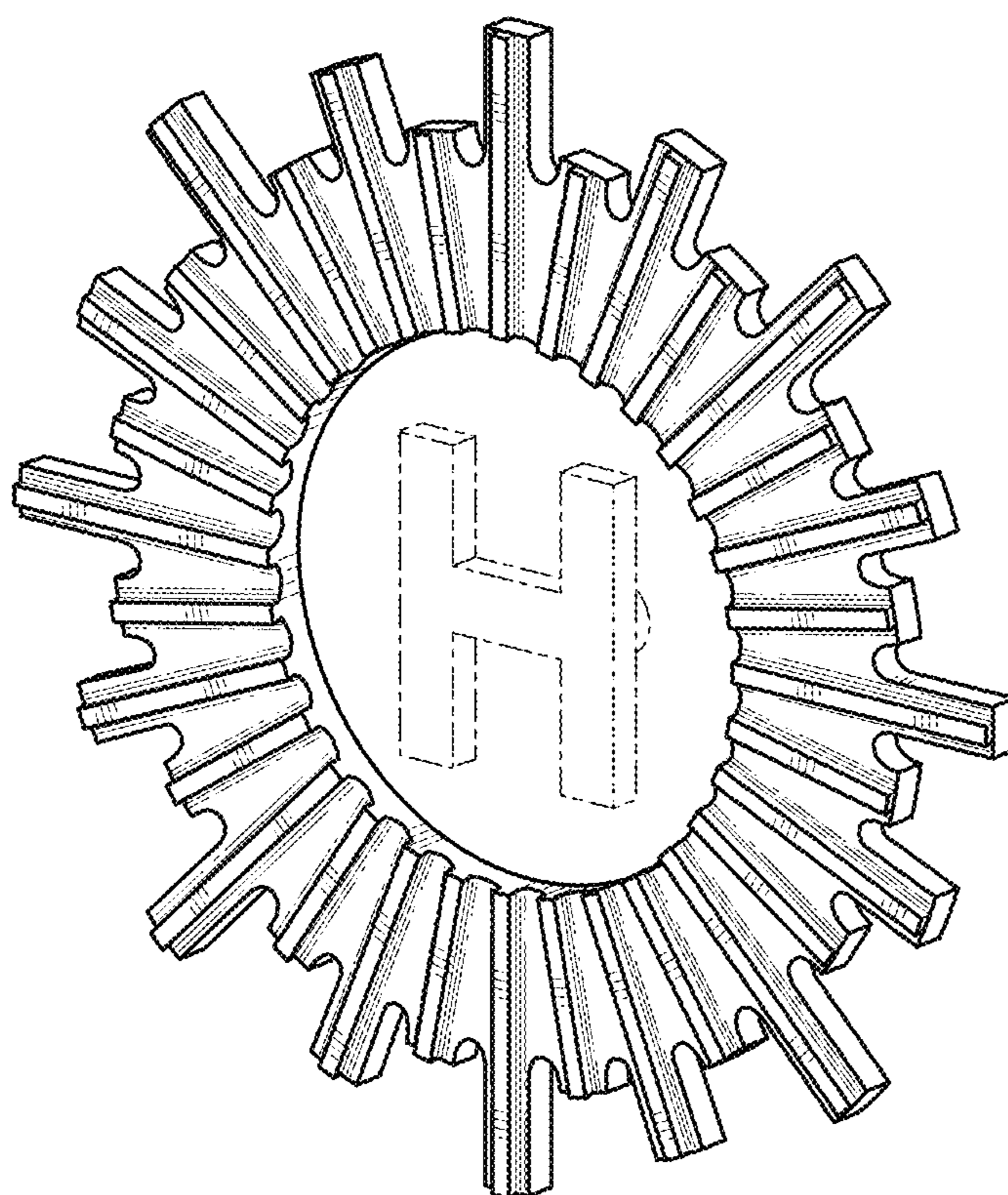

FIG. 12

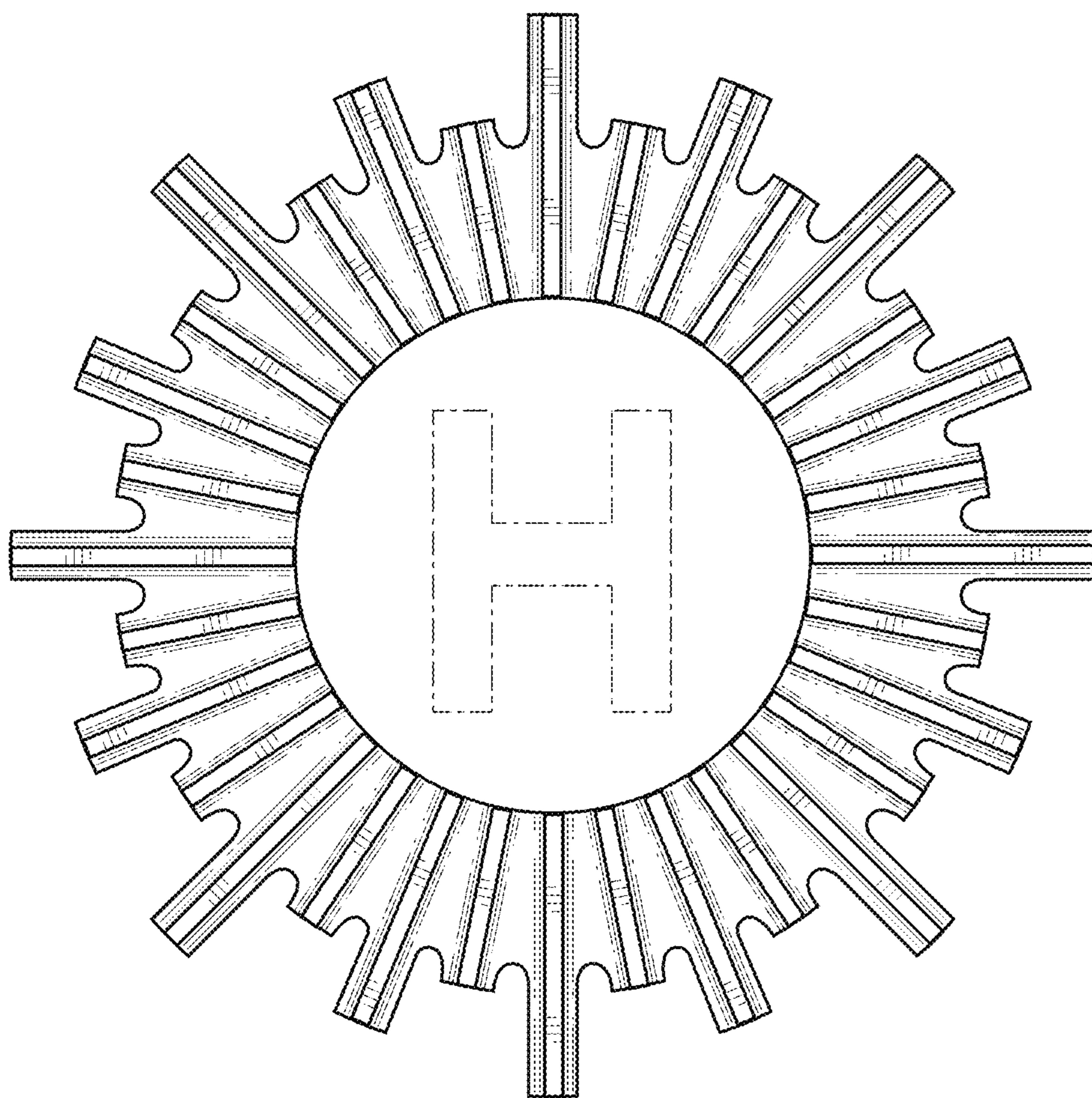

FIG. 13

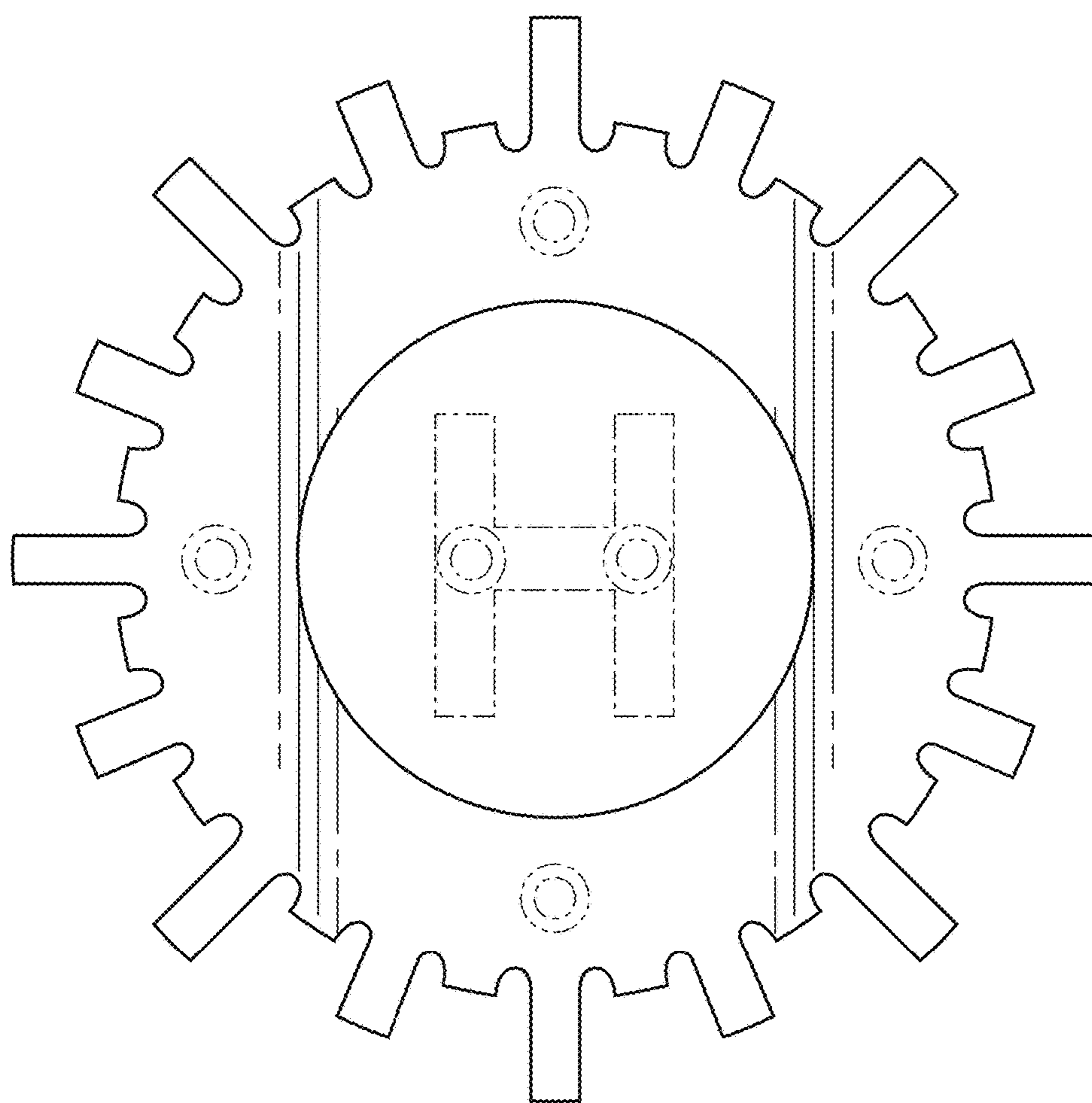

FIG. 14



FIG. 15

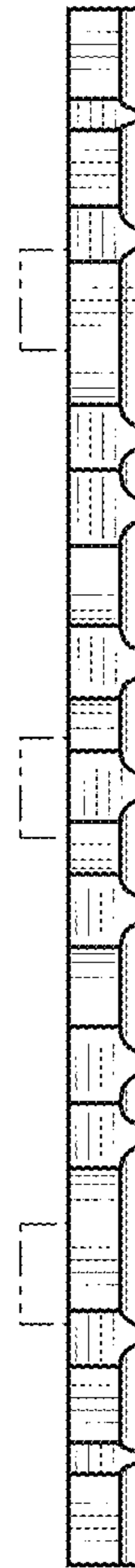

FIG. 16



FIG. 17



FIG. 18

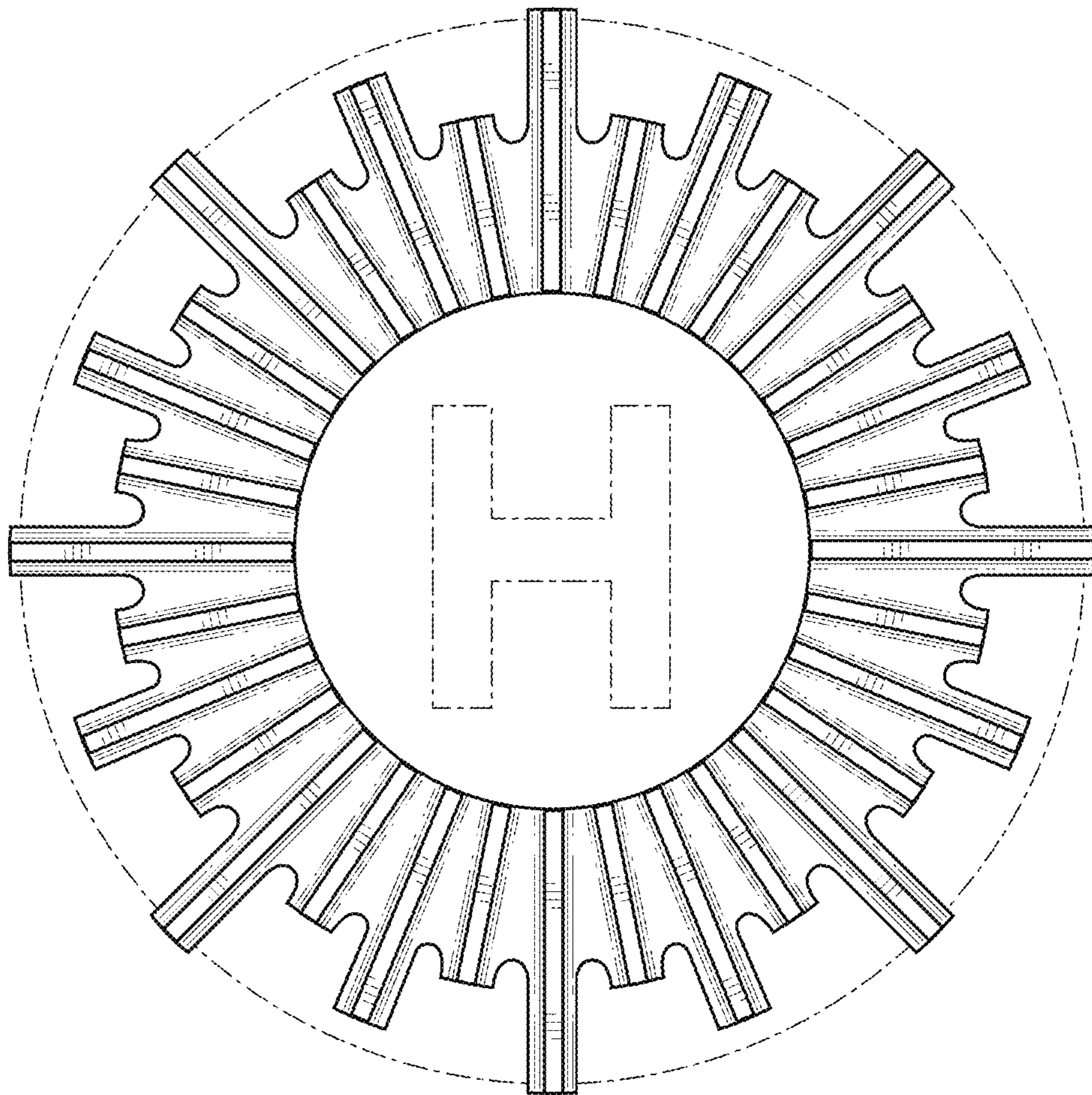

FIG. 19



FIG. 20

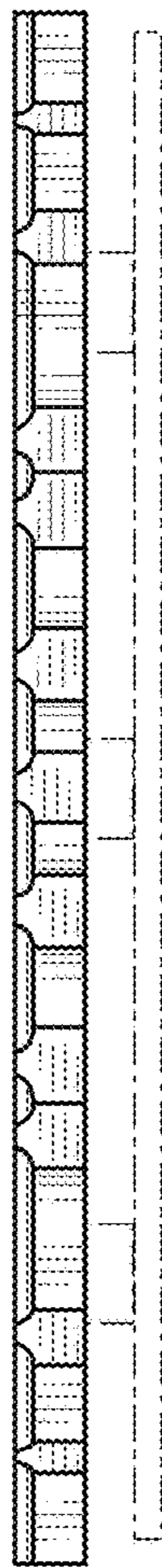

FIG. 21

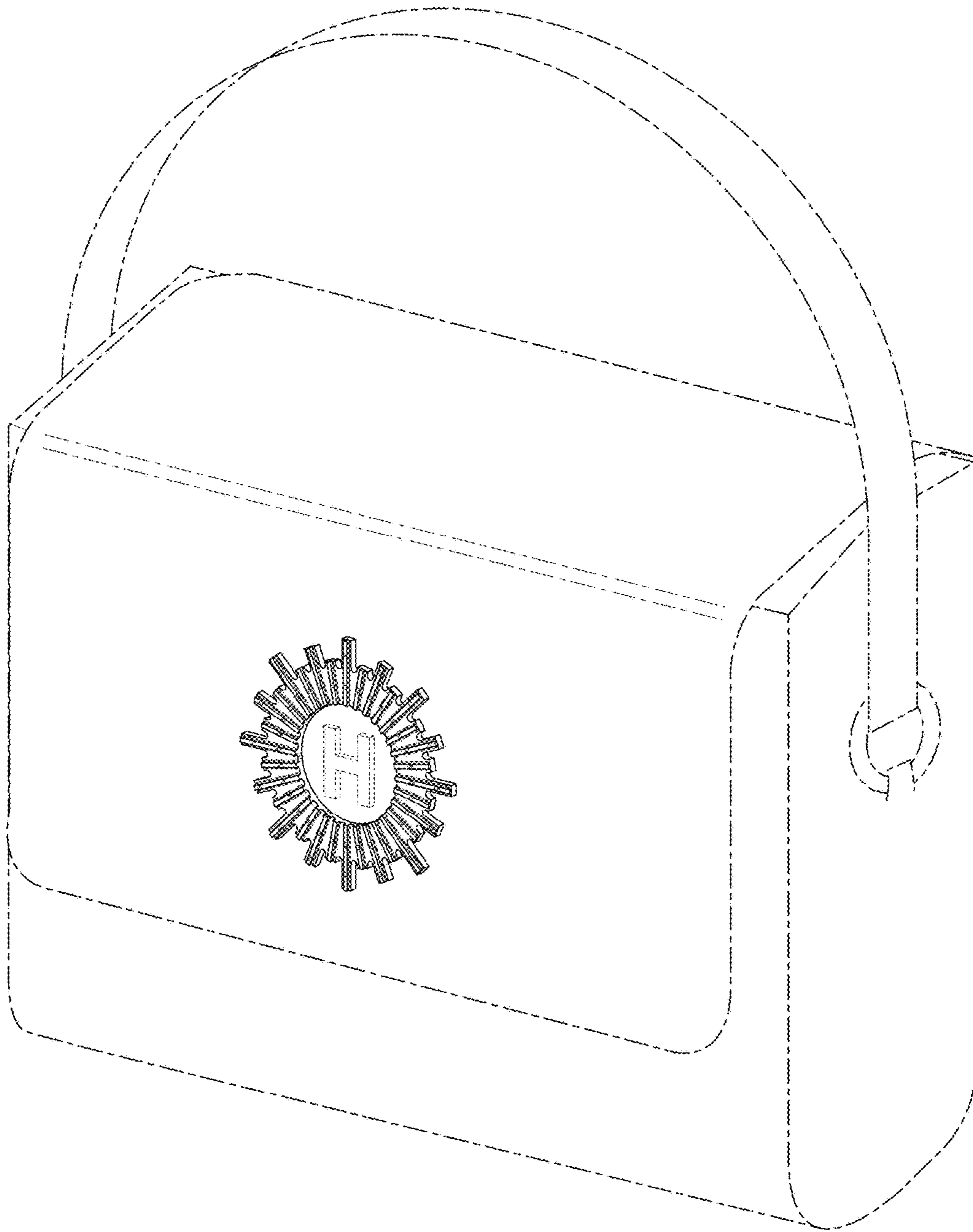

FIG. 22

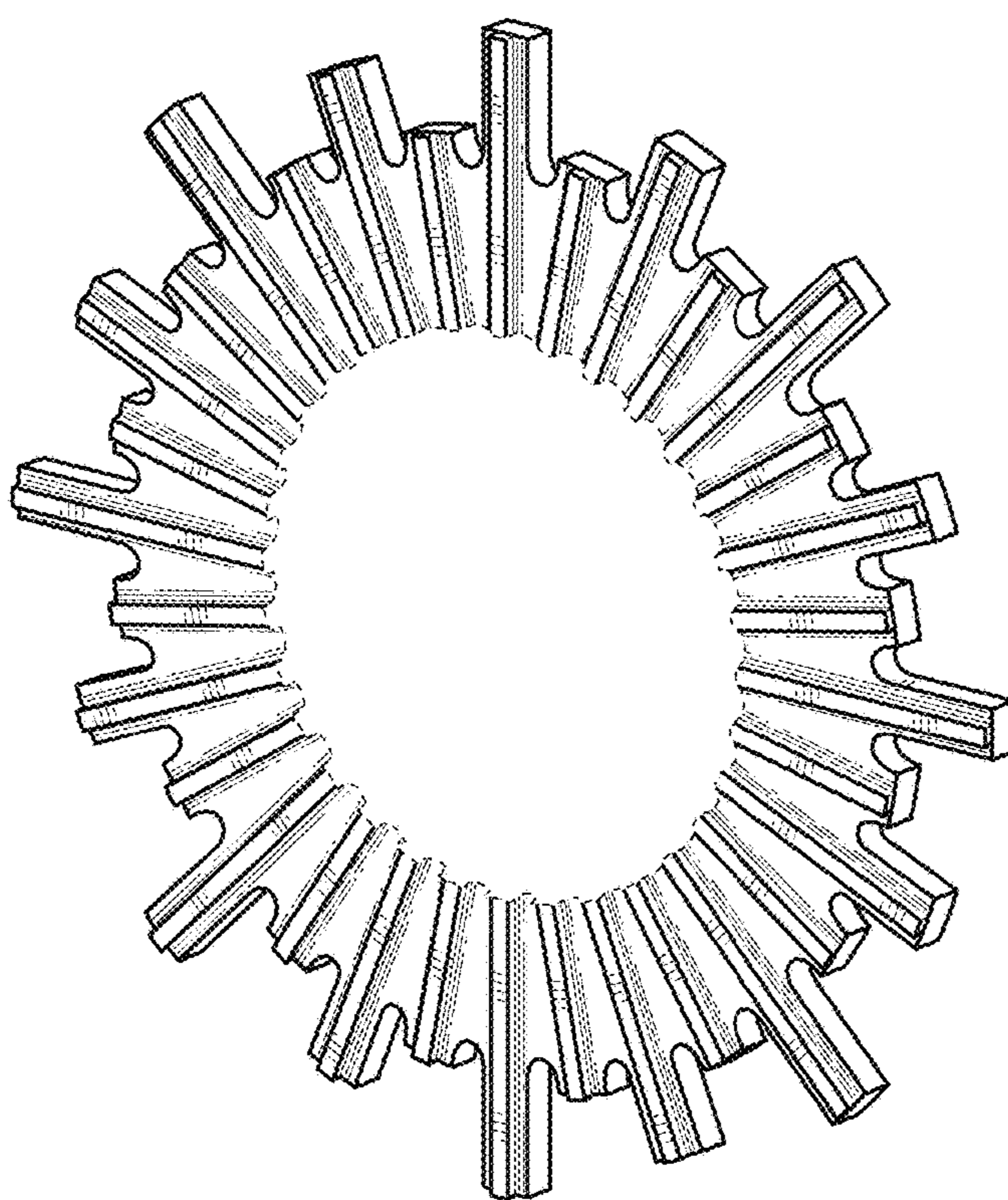

FIG. 23

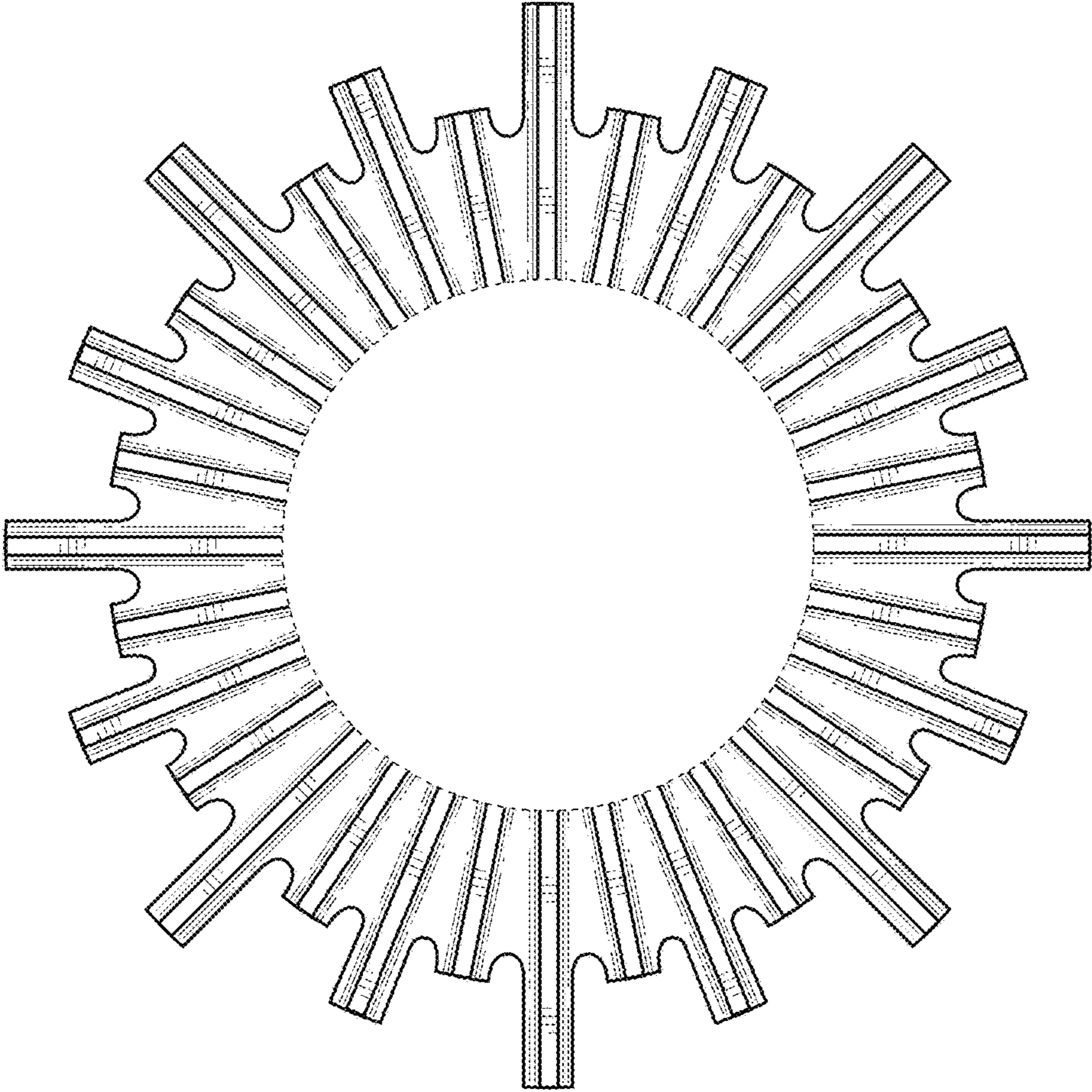

FIG. 24

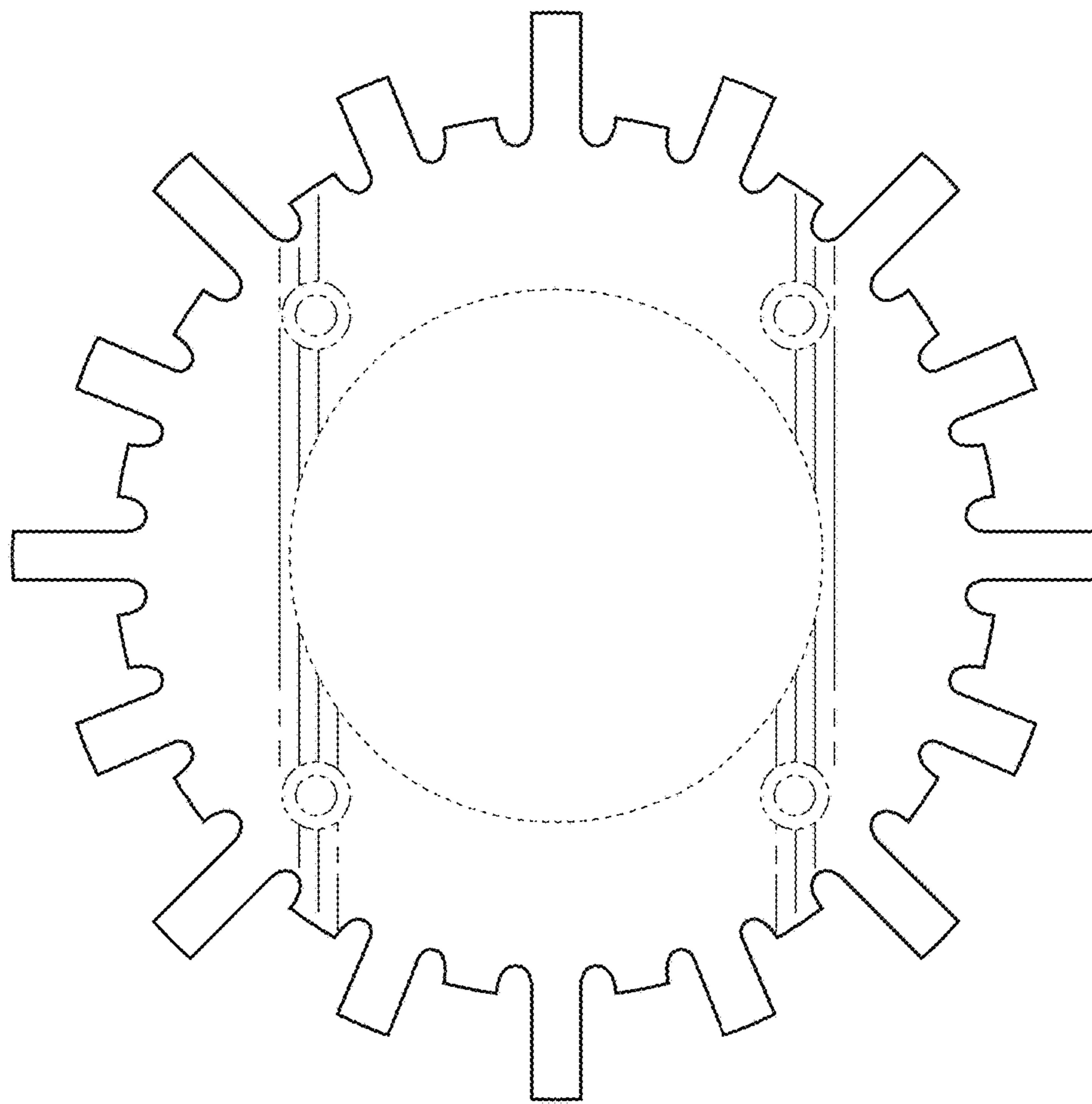

FIG. 25

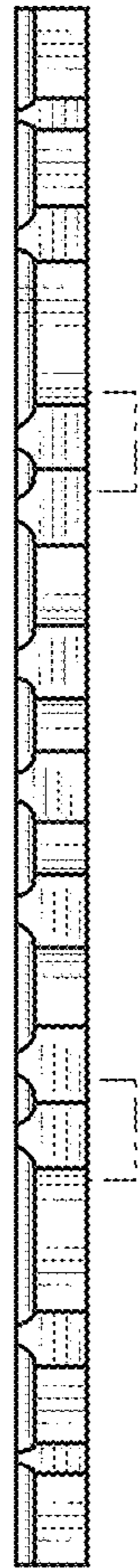

FIG. 26



FIG. 27



FIG. 28

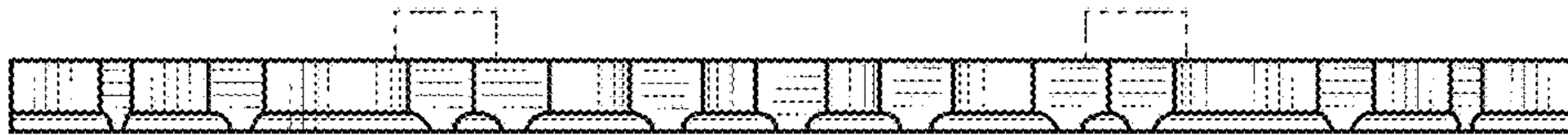

FIG. 29

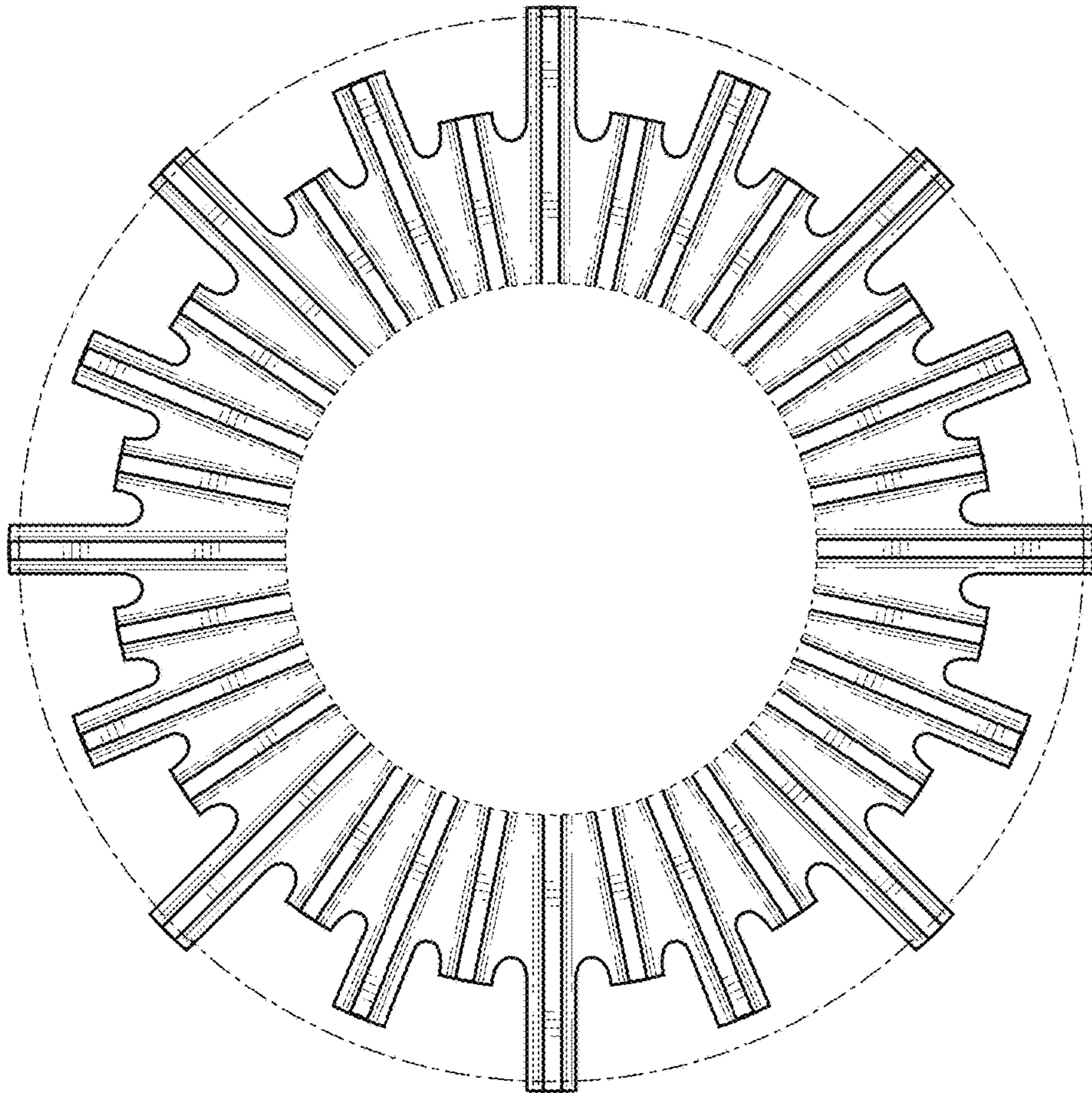

FIG. 30



FIG. 31

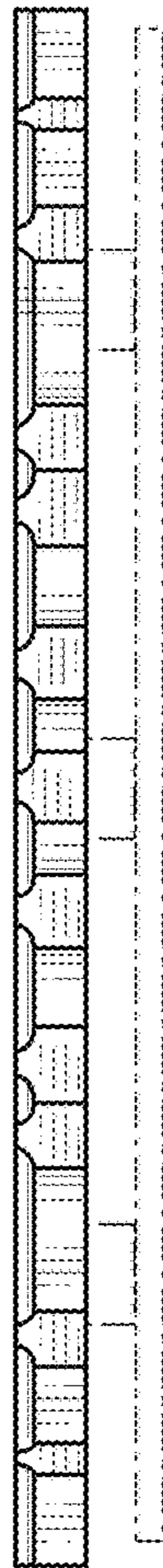

FIG. 32

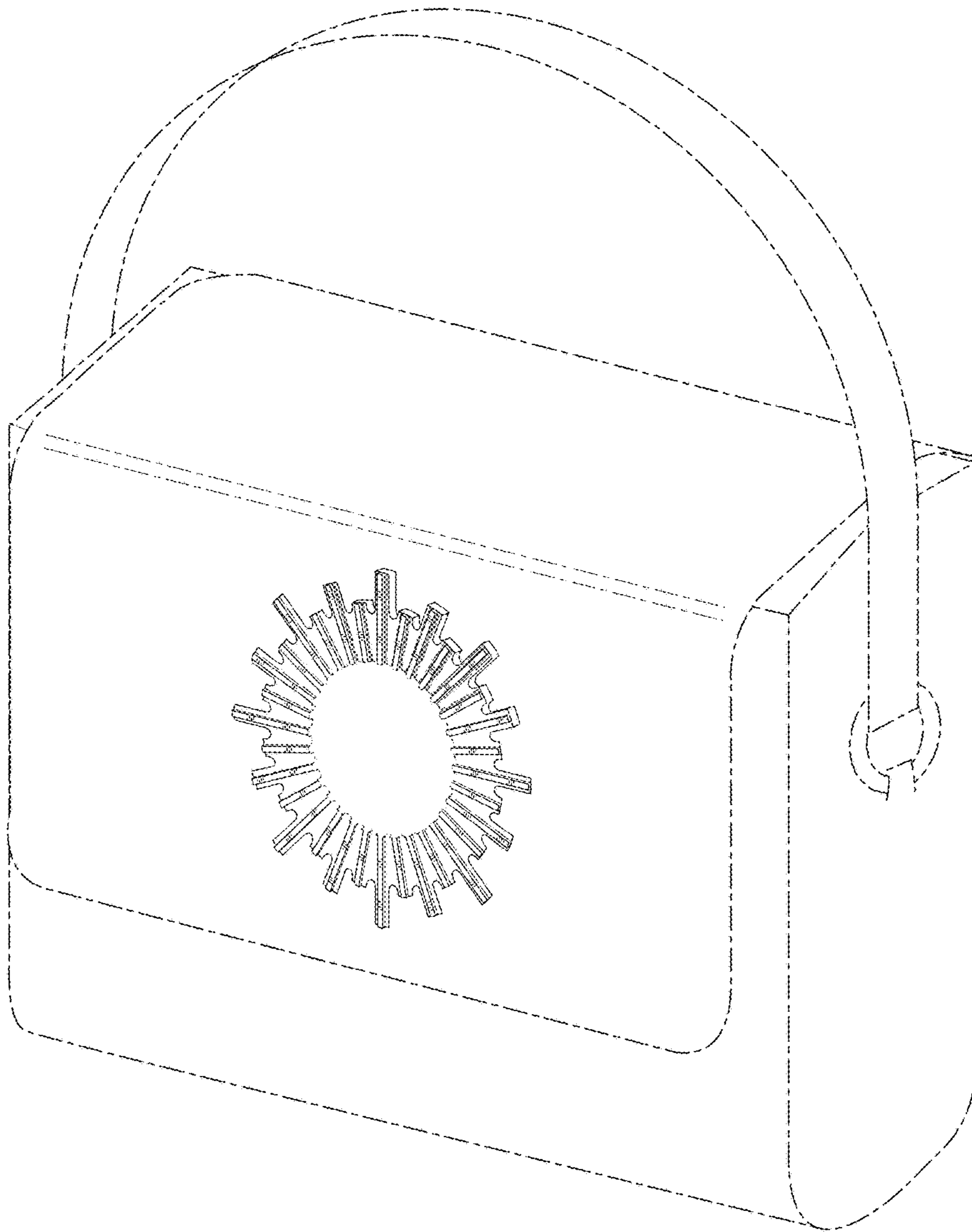

FIG. 33