

US00D856636S

(12) **United States Design Patent** (10) **Patent No.:** **US D856,636 S**  
**Johnson** (45) **Date of Patent:** **\*\* Aug. 20, 2019**

(54) **TOP WITH POCKET FOR HAND GUN,  
KNIFE OR SPARE MAGAZINE**

(71) Applicant: **Pamela Johnson**, Maplewood, MO  
(US)

(72) Inventor: **Pamela Johnson**, Maplewood, MO  
(US)

(\*\*) Term: **15 Years**

(21) Appl. No.: **29/603,461**

(22) Filed: **May 10, 2017**

(51) **LOC (12) Cl.** ..... **02-02**

(52) **U.S. Cl.**  
USPC ..... **D2/875**

(58) **Field of Classification Search**  
USPC ..... D2/828, 875, 750, 717  
CPC ..... A41D 27/20  
See application file for complete search history.

(56) **References Cited**

**U.S. PATENT DOCUMENTS**

- 2,323,390 A \* 7/1943 Friedman ..... A41D 27/20  
2/253
- 2,604,627 A \* 7/1952 Abbott ..... A41D 27/20  
2/115
- 2,732,560 A \* 1/1956 Frederiksen ..... A41D 27/207  
2/254
- 3,220,017 A \* 11/1965 Morton ..... A41D 1/06  
2/237
- 3,530,508 A \* 9/1970 Pavlou ..... A41D 1/04  
2/102

(Continued)

*Primary Examiner* — Kevin K Rudzinski  
(74) *Attorney, Agent, or Firm* — C4 The Concealed Carry  
Clothing Company LLC; Pamela Johnson

(57) **CLAIM**

The ornamental design for a top with pocket for hand gun, knife or spare magazine, as shown and described.

**DESCRIPTION**

FIG. 1 is a front view of a first embodiment of a top with pocket for hand gun, knife or spare magazine  
 FIG. 2 is a rear view thereof;  
 FIG. 3 is a right side view thereof;  
 FIG. 4 is a left side view thereof;  
 FIG. 5 is a three- quarter front view of a second embodiment of a top with pocket for hand gun, knife or spare magazine  
 FIG. 6 is a rear view thereof;  
 FIG. 7 is a right side view thereof;  
 FIG. 8 is a left side view thereof.  
 FIG. 9 is a front view of a third embodiment of a top with pocket for hand gun, knife or spare magazine;  
 FIG. 10 is a rear view thereof;  
 FIG. 11 is a right side view thereof;  
 FIG. 12 is a left side view thereof.  
 FIG. 13 is a front view of a fourth embodiment of a top with pocket for hand gun, knife or spare magazine;  
 FIG. 14 is a rear view thereof;  
 FIG. 15 is a right side view thereof;  
 FIG. 16 is a left side view thereof.  
 FIG. 17 is a right flat side view thereof;  
 FIG. 18 is a flat left side view thereof;  
 FIG. 19 is a top view thereof;  
 FIG. 20 is a bottom view thereof.  
 FIG. 21 is an embodiment of the pocket, with the hand gun outside the pocket; and,  
 FIG. 22 is an embodiment of the pocket with the hand gun inserted.

In all the FIGURES, the small dashed lines shown directly on the surface of the claimed article, throughout the views, are understood to represent stitching that forms part of the claim. The broken lines showing the hand gun, garment and straps in the figures form no part of the claimed design.

**1 Claim, 3 Drawing Sheets**

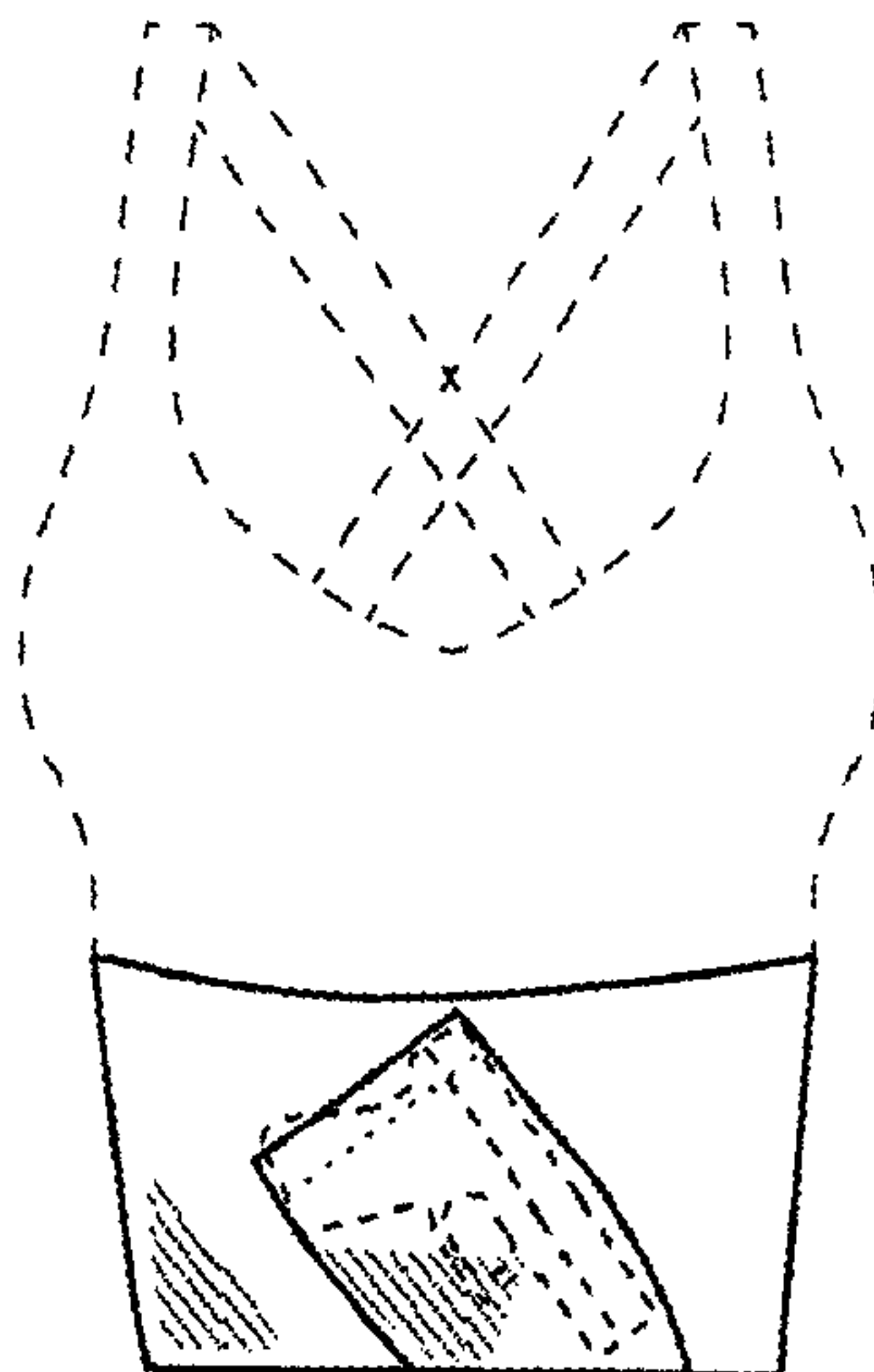

(56)

**References Cited**

U.S. PATENT DOCUMENTS

3,561,394 A \* 2/1971 Pickens ..... A41D 13/01  
 116/200  
 D294,651 S \* 3/1988 Ferre ..... D2/742  
 5,884,338 A \* 3/1999 Golde ..... A41D 27/20  
 2/247  
 5,940,883 A \* 8/1999 Daoust ..... A41D 13/0012  
 2/102  
 D416,125 S \* 11/1999 Falk ..... D2/828  
 6,264,079 B1 \* 7/2001 Skaggs ..... F41C 33/0236  
 224/193  
 D639,027 S \* 6/2011 Seguin ..... D2/857  
 8,458,819 B1 \* 6/2013 Hoole ..... A41B 9/001  
 2/247  
 D690,086 S \* 9/2013 Estes ..... D2/840  
 9,009,870 B1 \* 4/2015 Connick, Jr. .... A41D 27/20  
 2/252  
 D736,492 S \* 8/2015 Kidman ..... D2/717  
 D742,624 S \* 11/2015 Meyers ..... D2/857  
 D746,553 S \* 1/2016 Emrich ..... D2/857  
 D749,297 S \* 2/2016 Kidman ..... D2/750  
 D805,735 S \* 12/2017 Duncan ..... D2/857  
 D806,991 S \* 1/2018 Razdan ..... D2/857  
 2008/0263742 A1 \* 10/2008 Vaughn ..... A41D 1/08  
 2/69  
 2009/0025117 A1 \* 1/2009 French ..... A41D 27/20  
 2/69  
 2009/0265835 A1 \* 10/2009 French ..... A41D 27/20  
 2/227  
 2016/0183614 A1 \* 6/2016 Kuipers ..... A41D 27/201  
 2/253

\* cited by examiner

Fig. 1

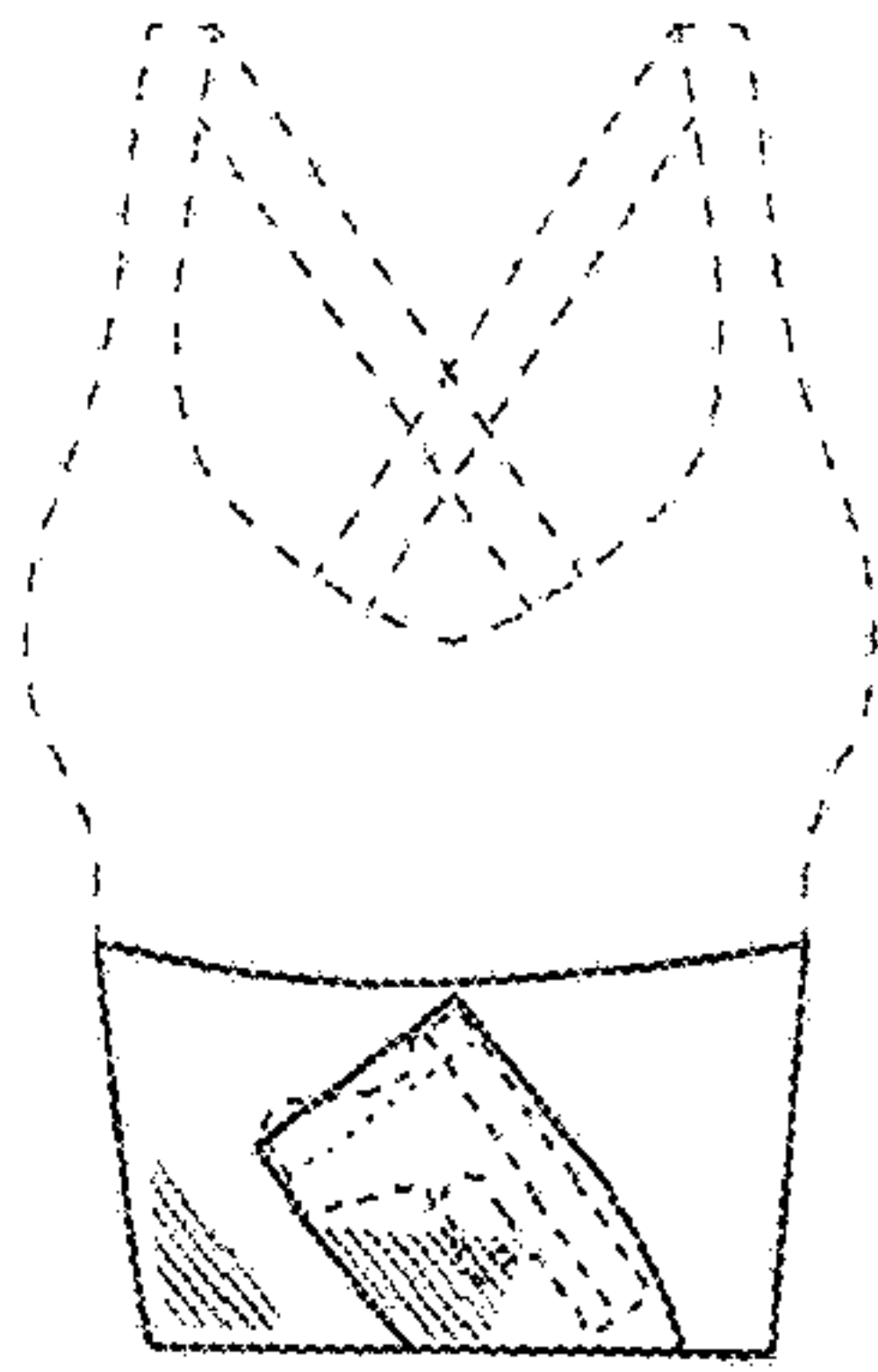

Fig. 2

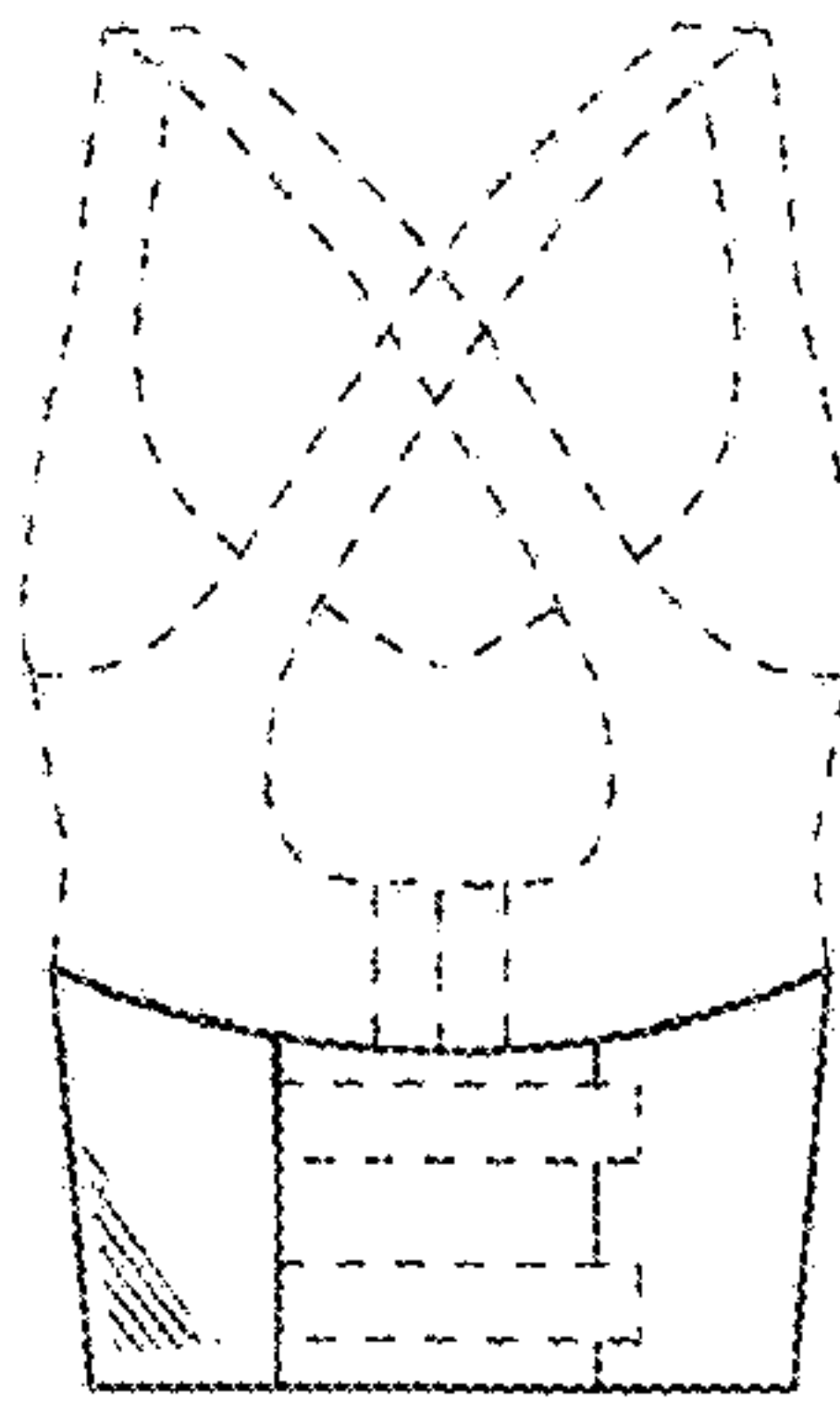

Fig. 3

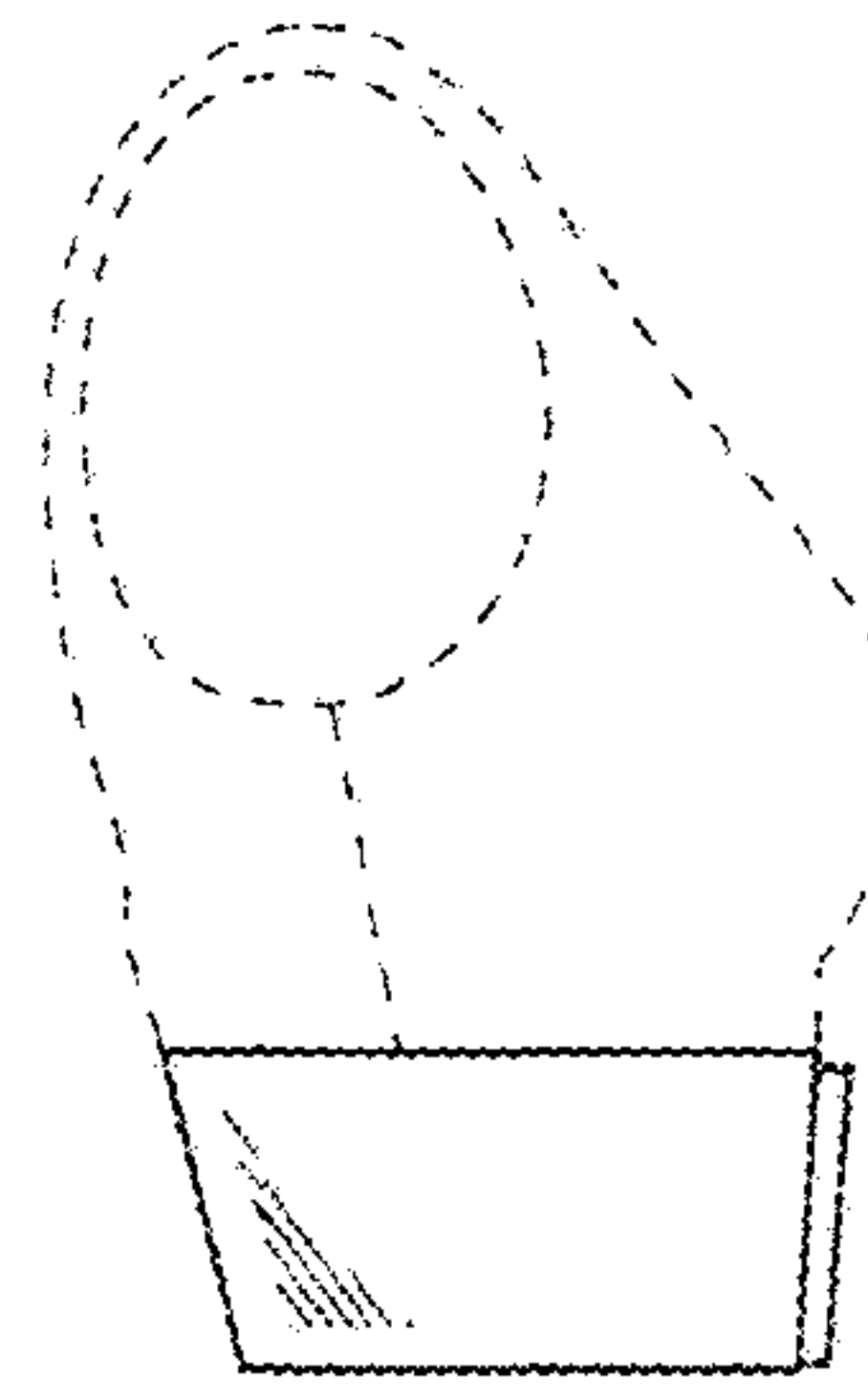

Fig. 4

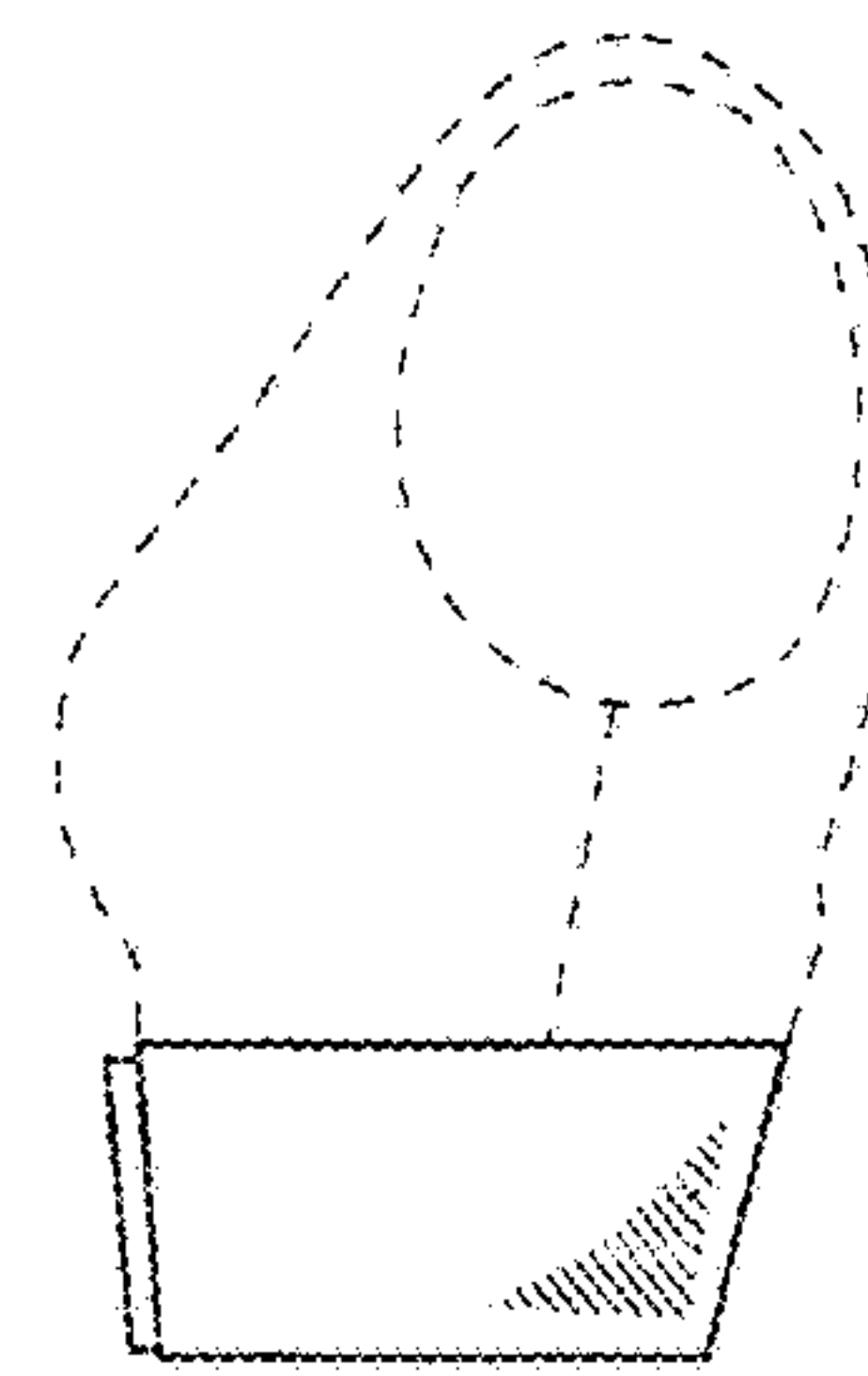

Fig. 5

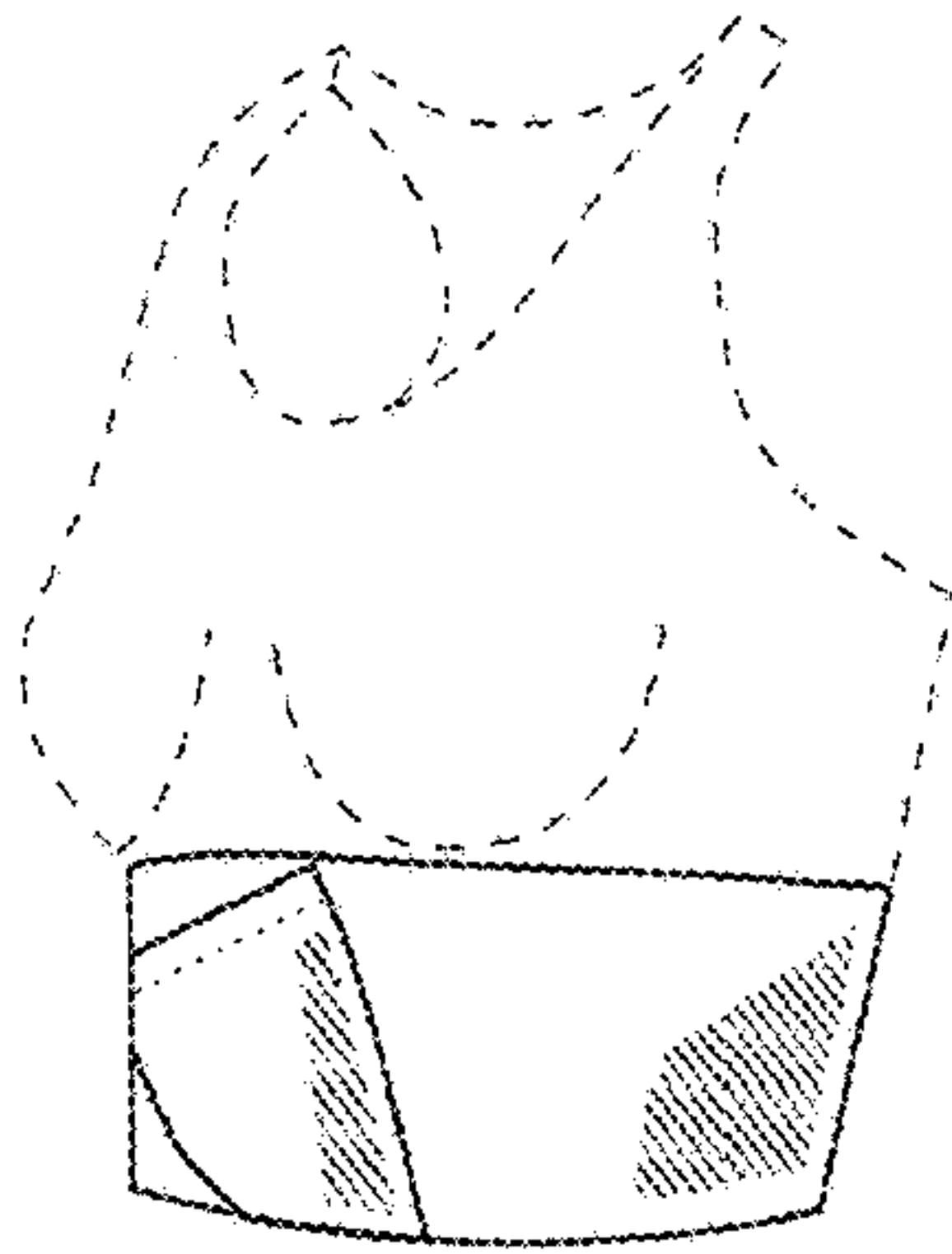

Fig. 6

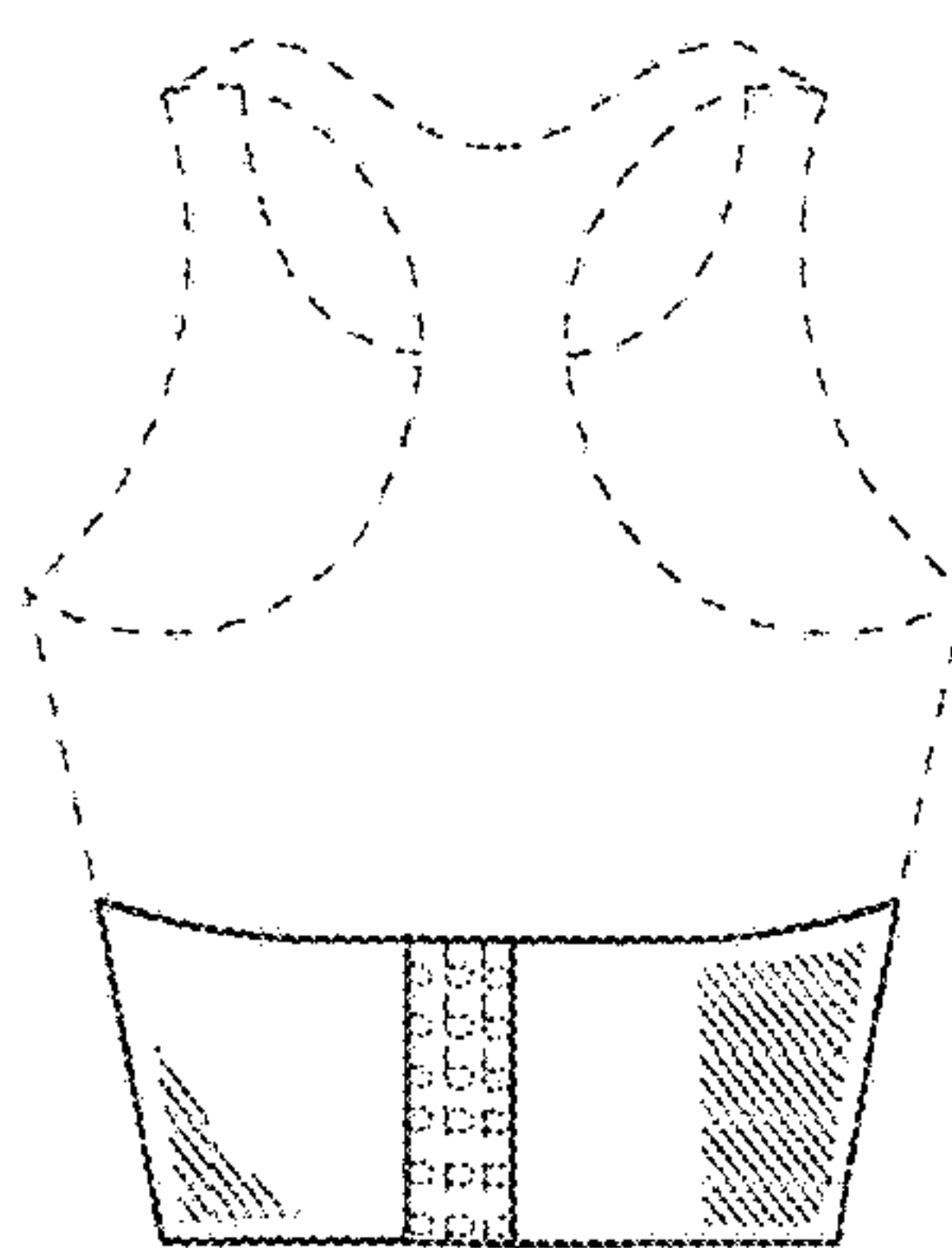

Fig. 7

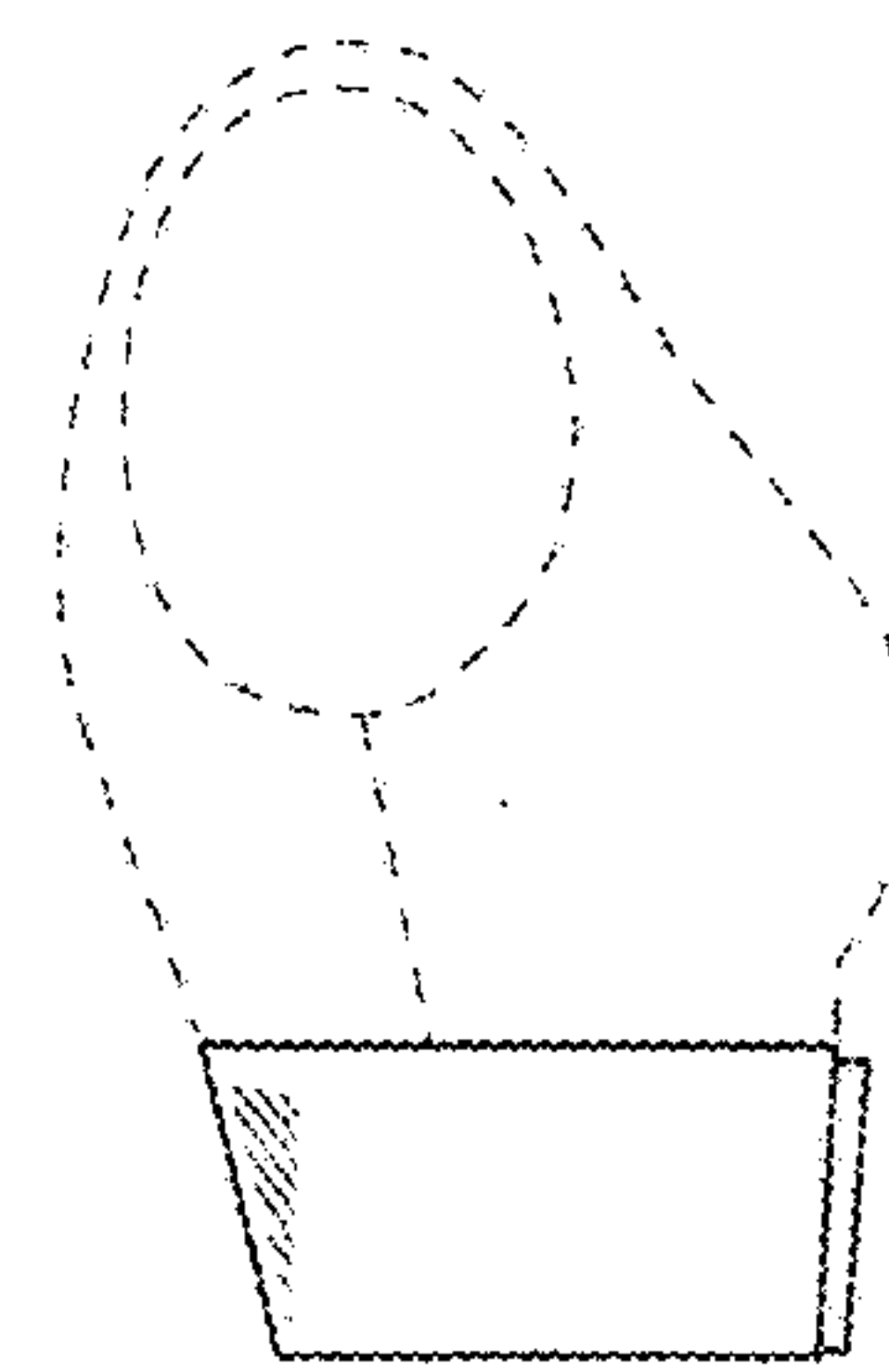

Fig. 8

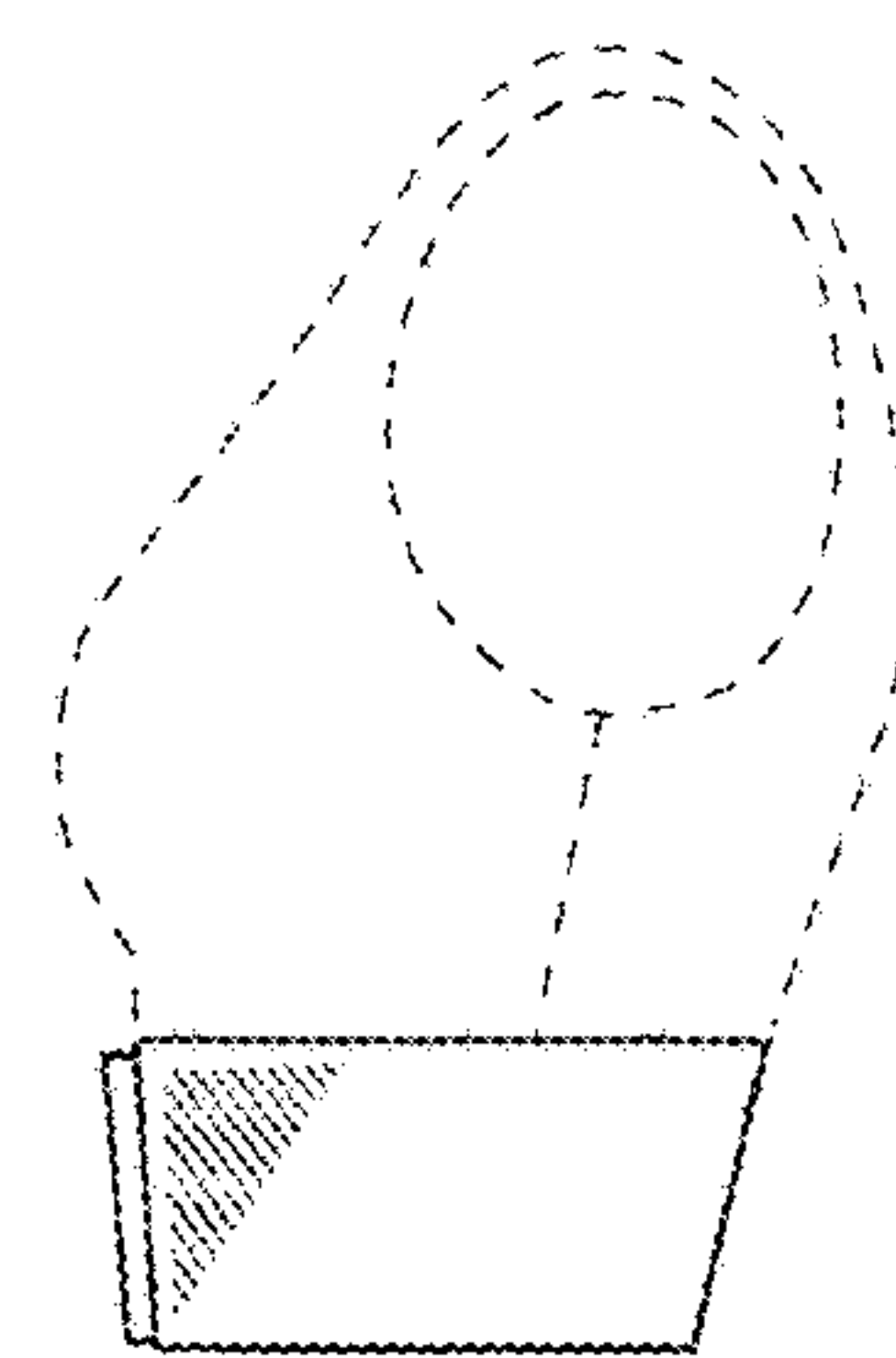

Fig. 9

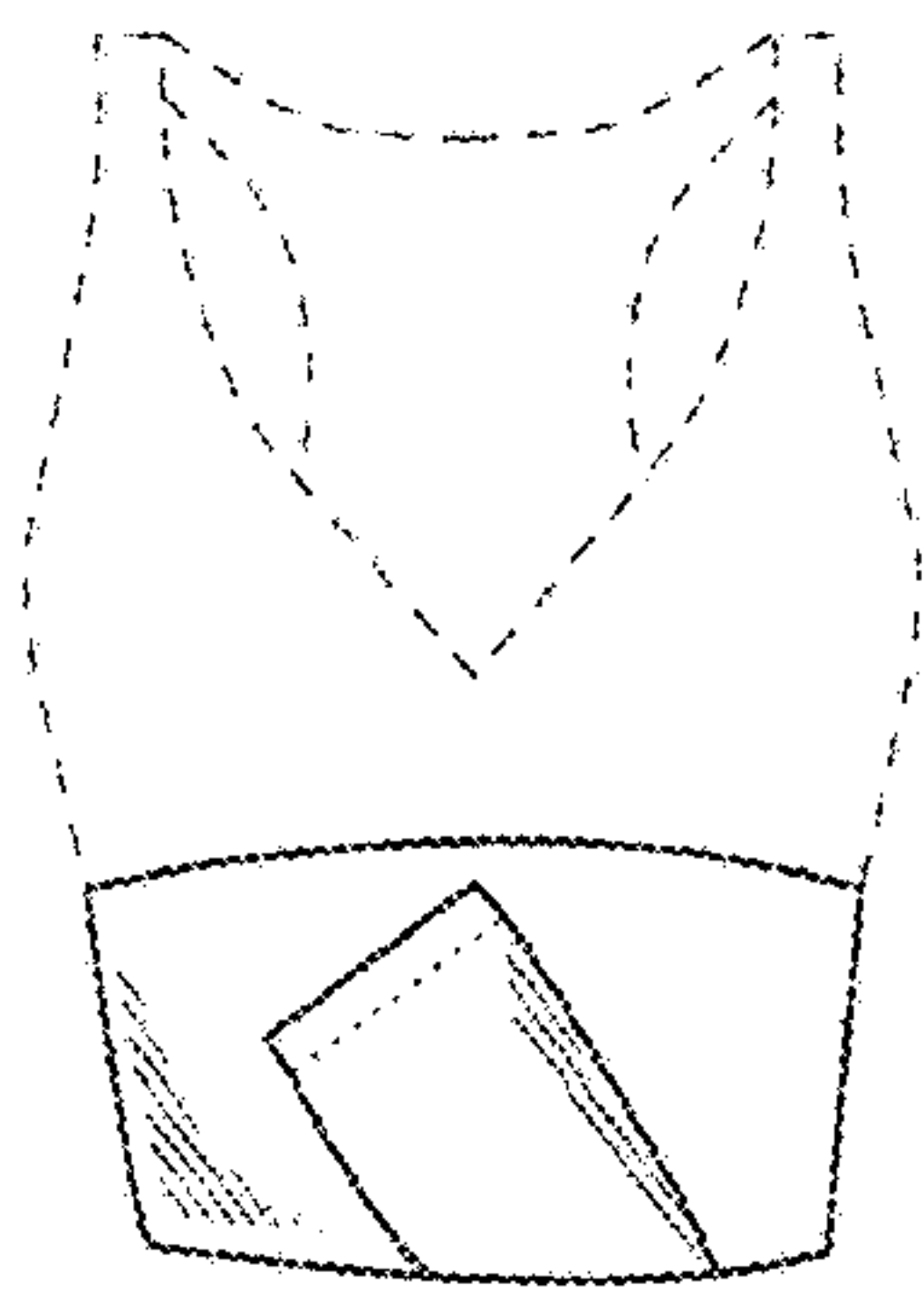

Fig. 10

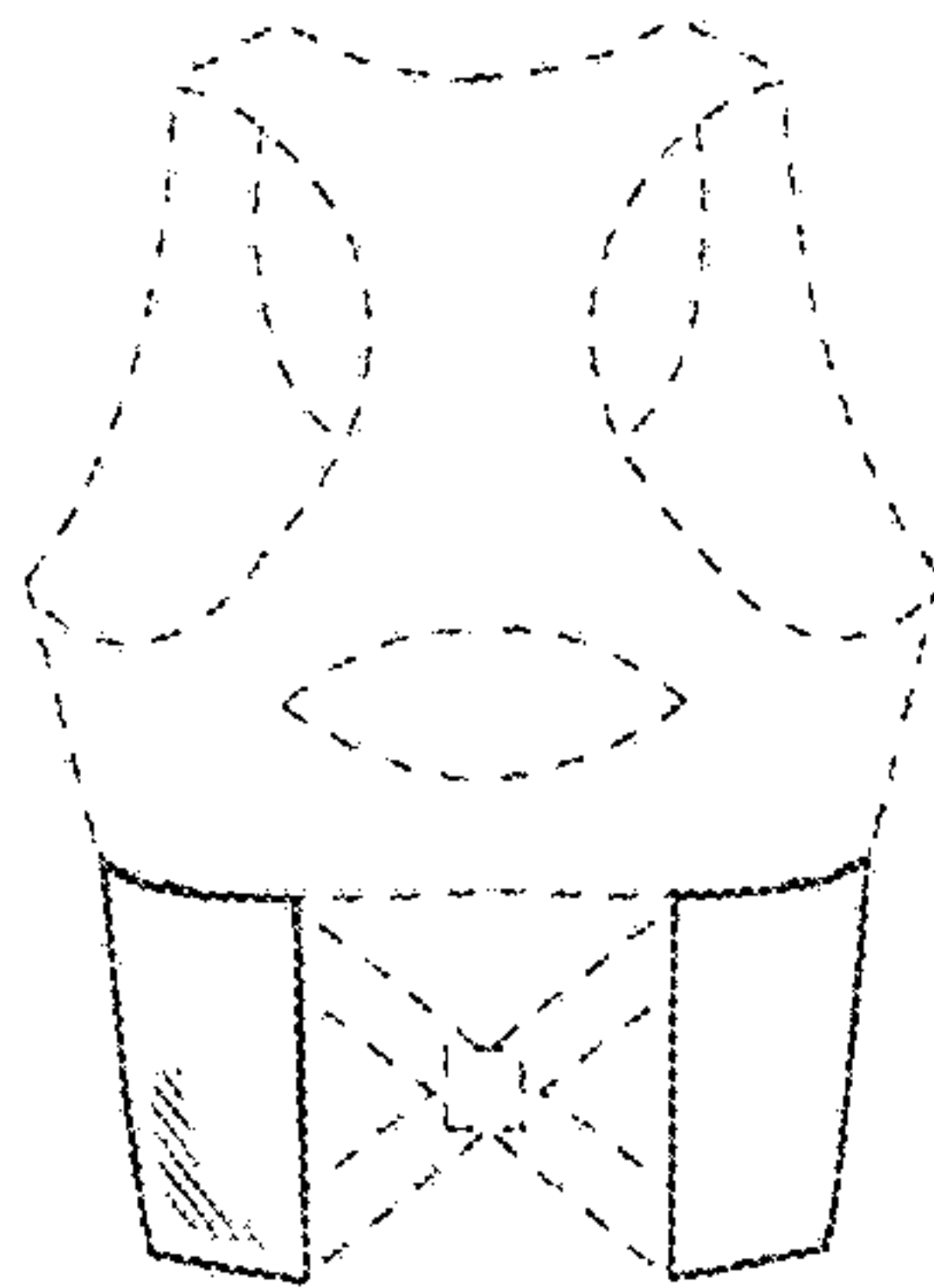

Fig. 11

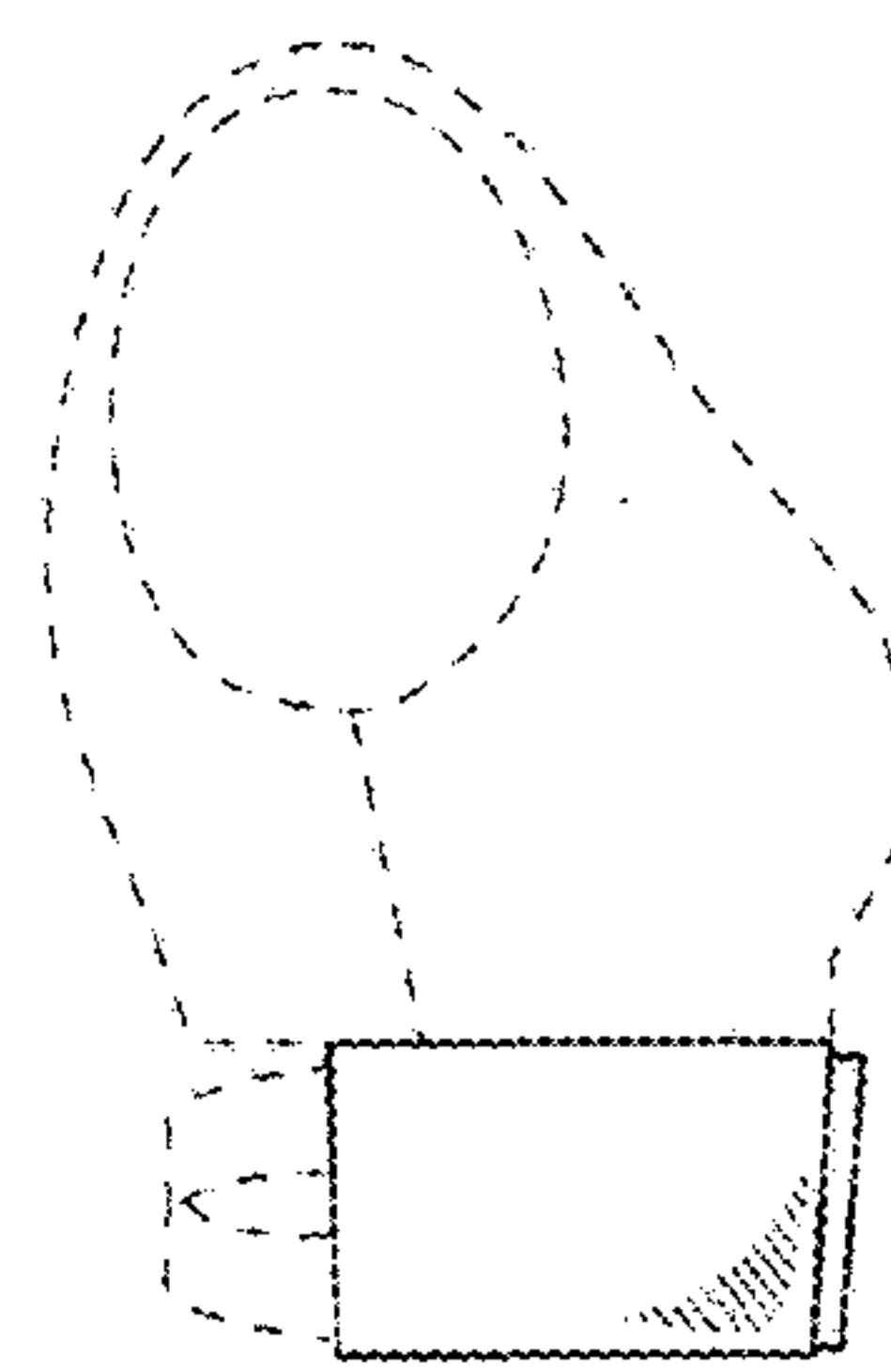

Fig. 12

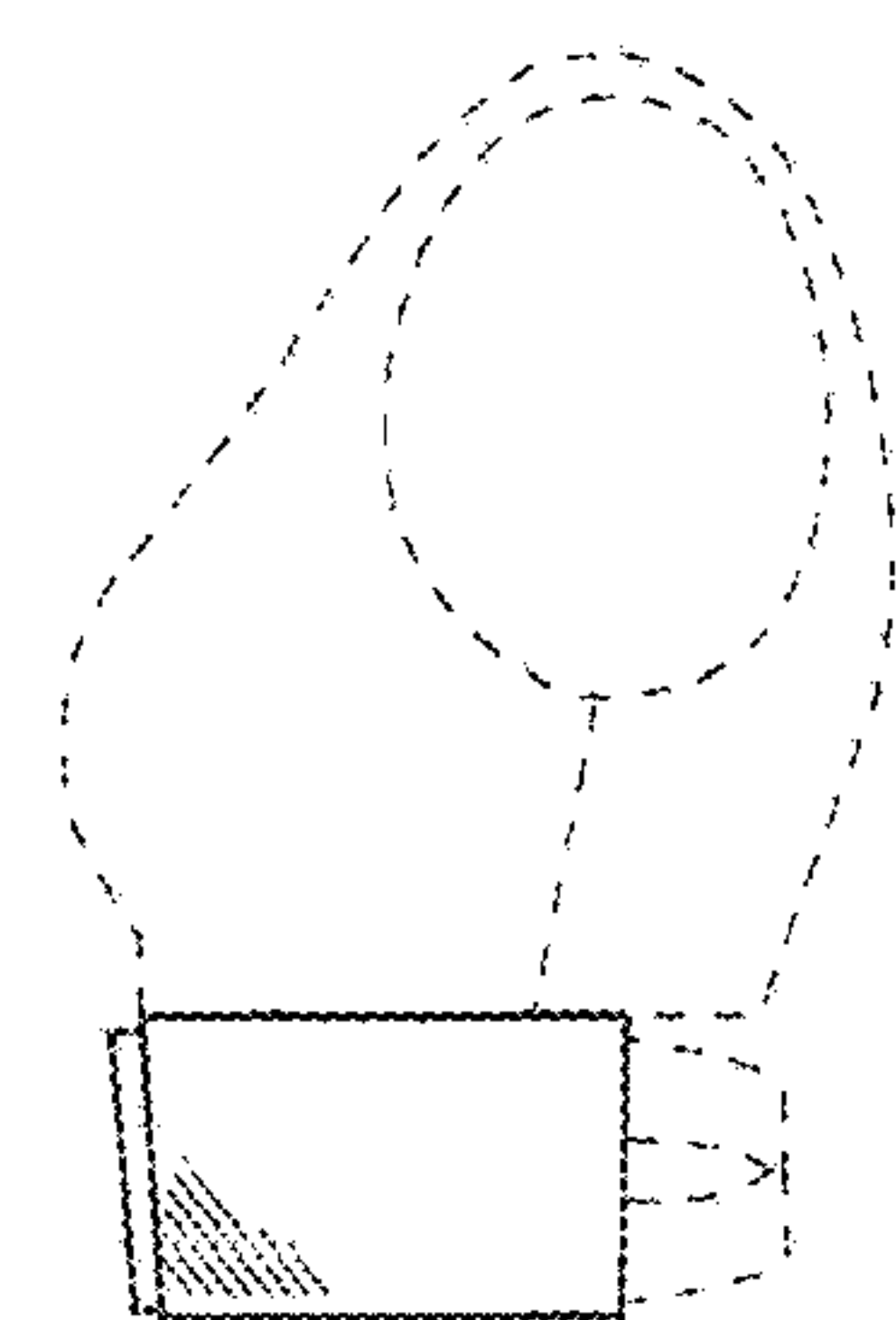

Fig. 13

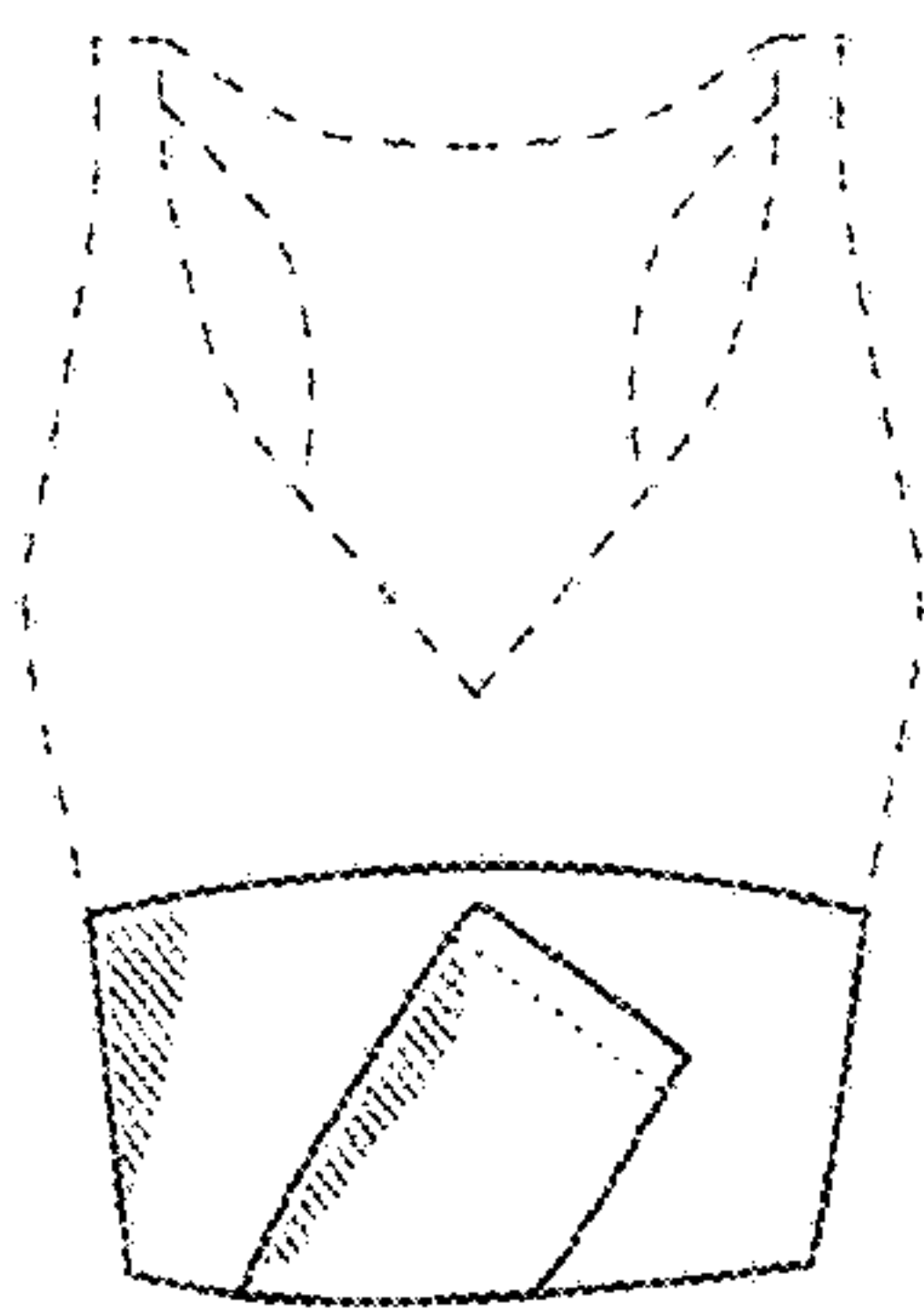

Fig. 14

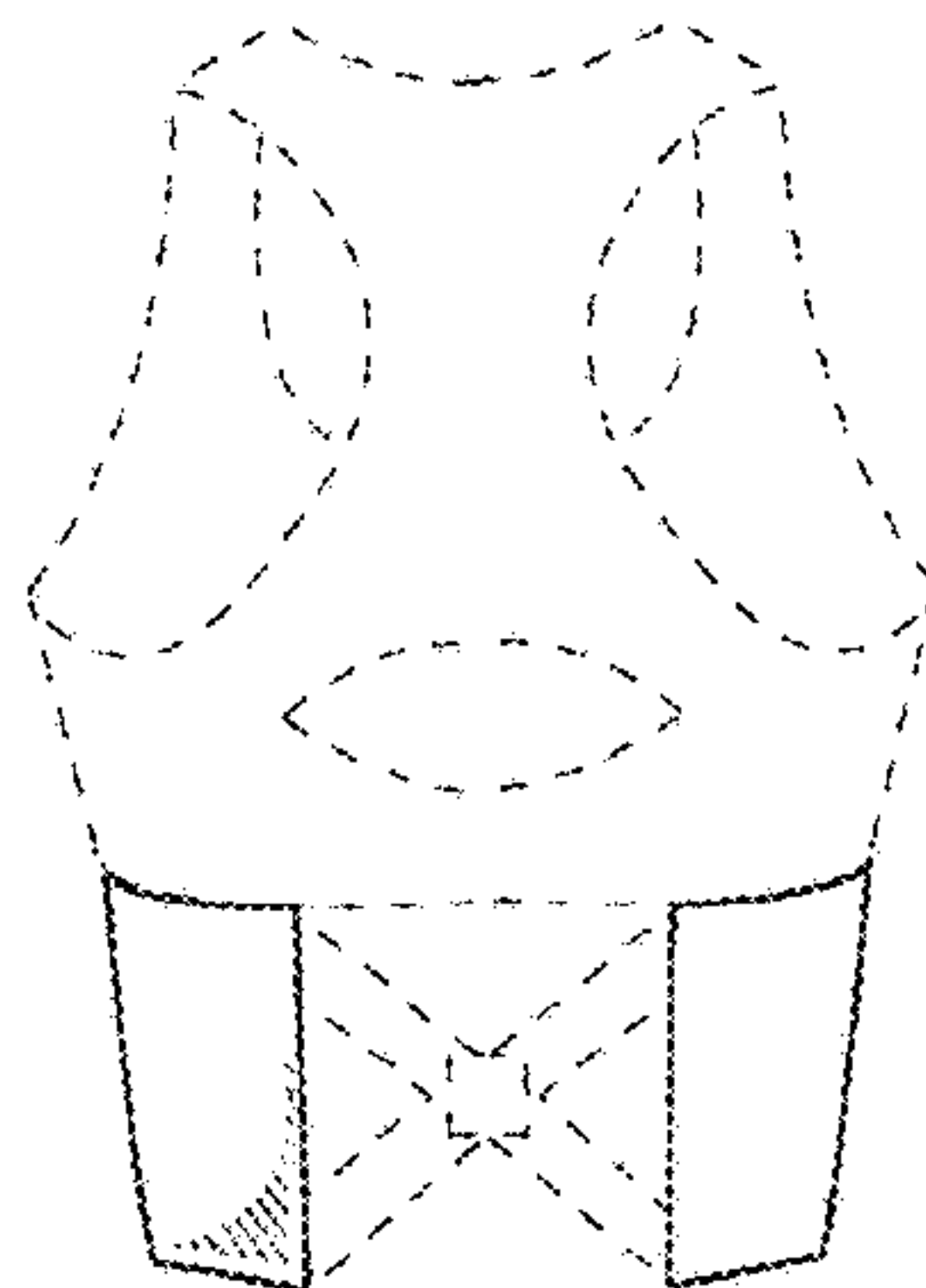

Fig. 15

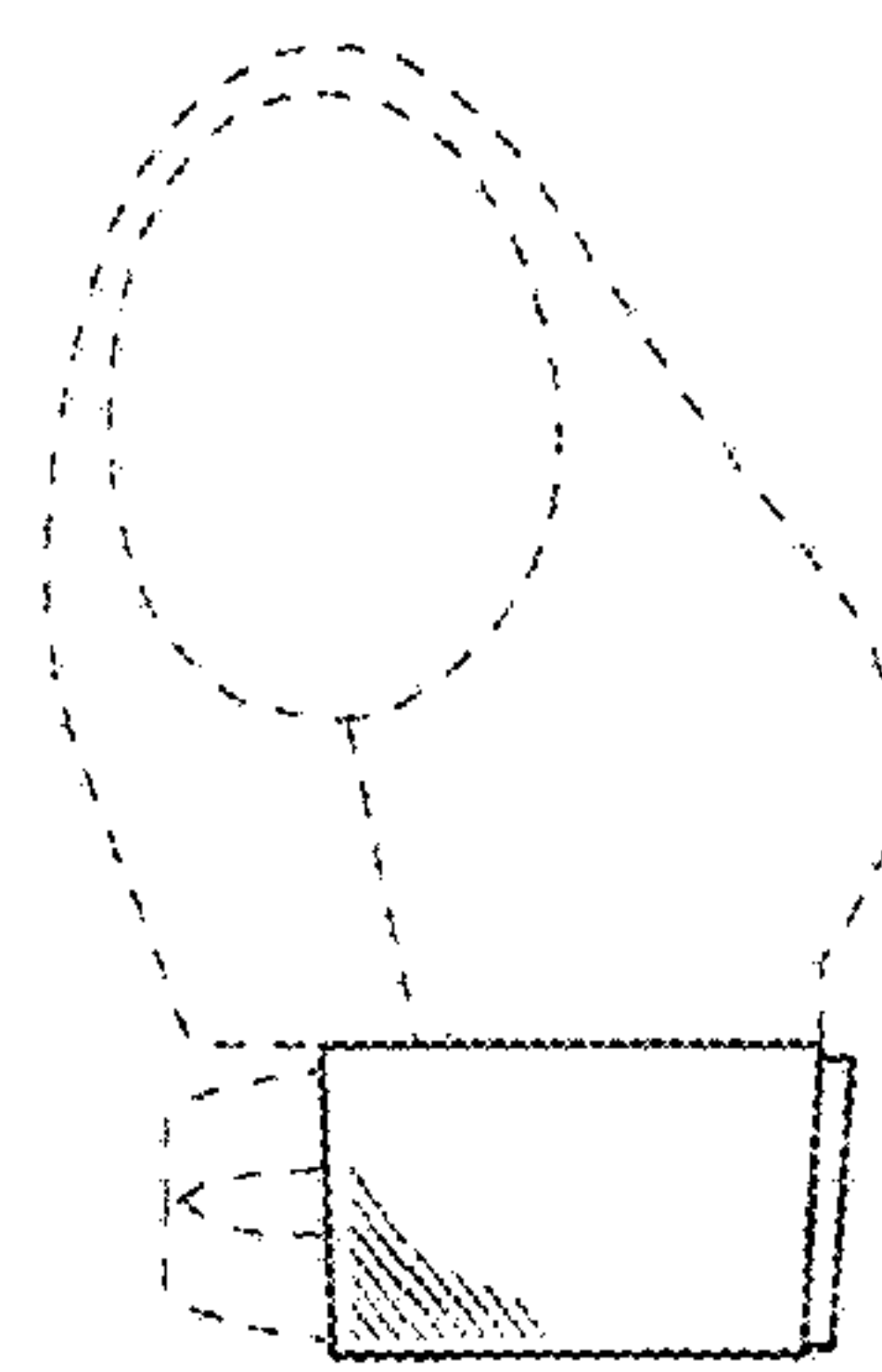

Fig. 16

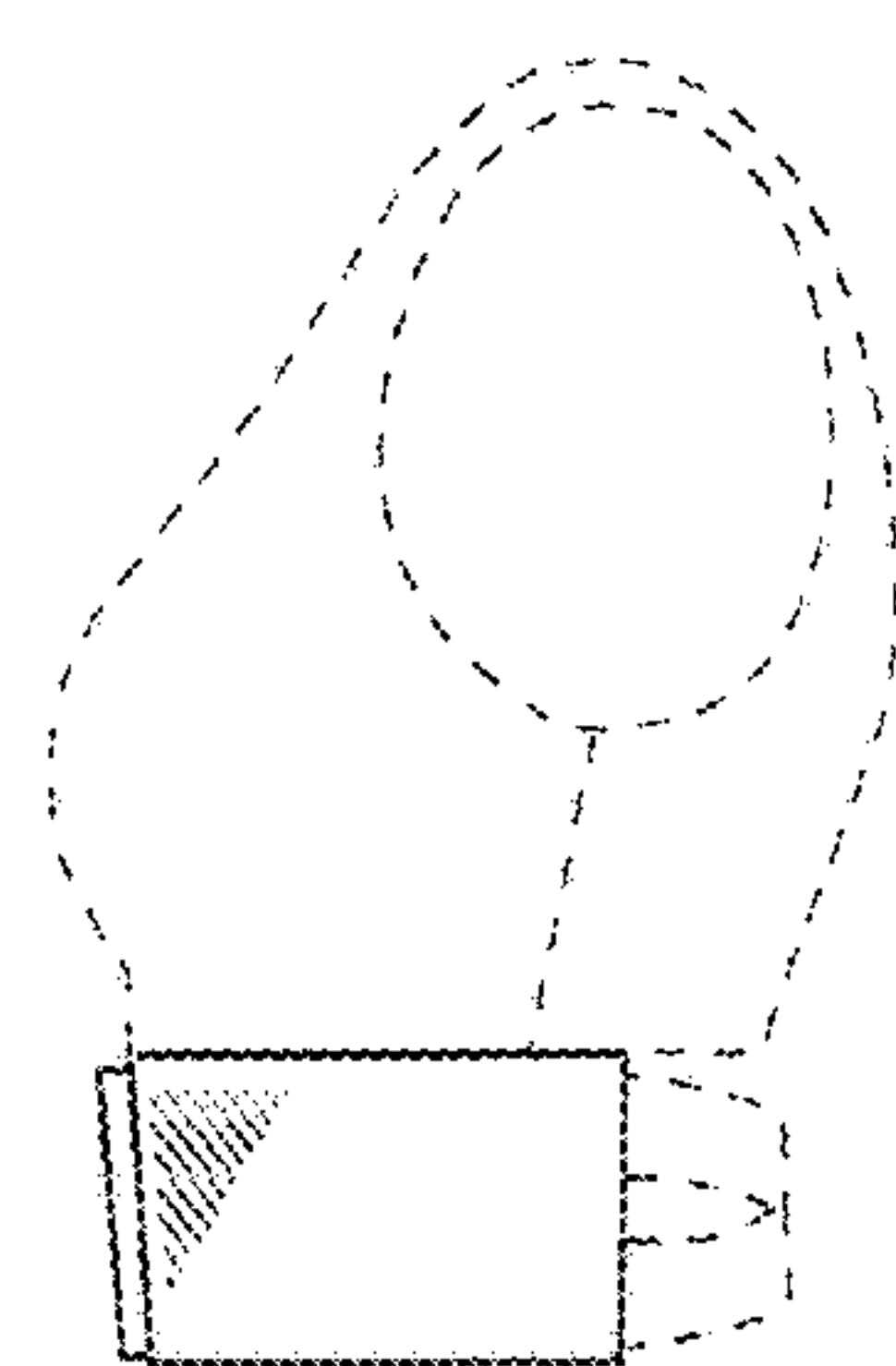

Fig. 17

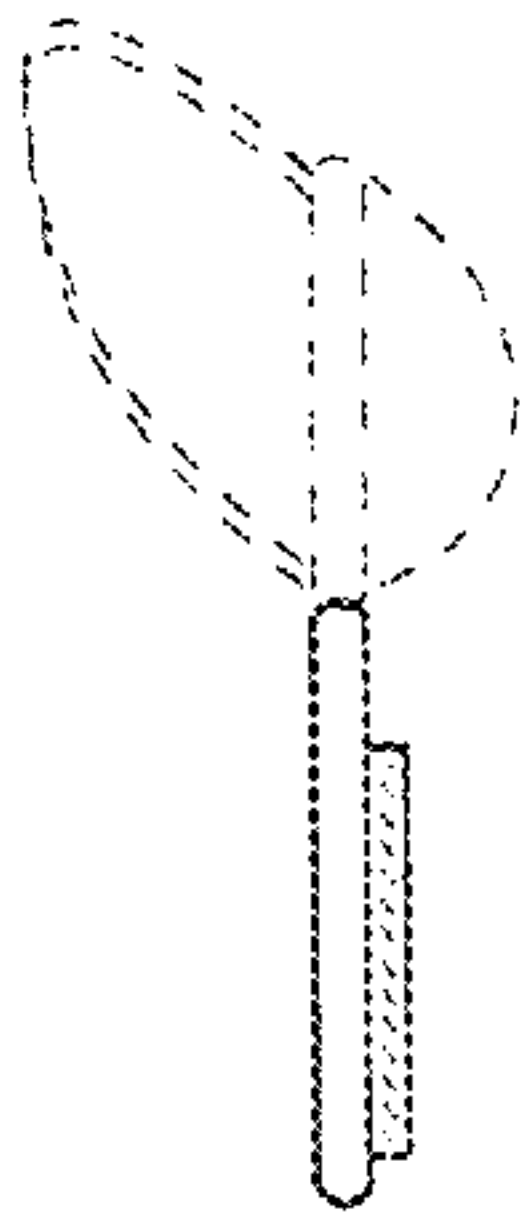

Fig. 18

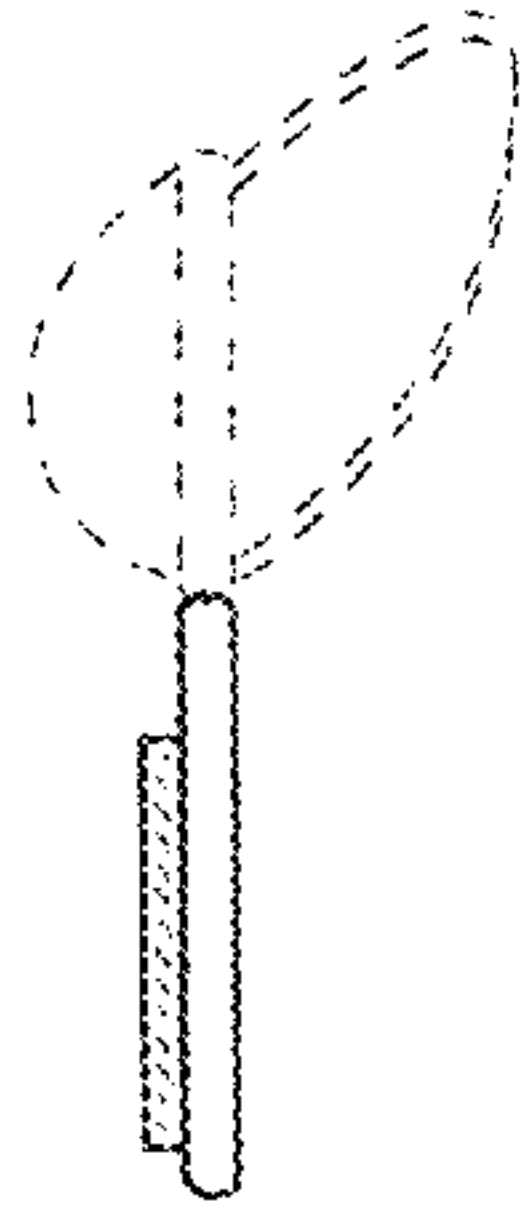

Fig. 19

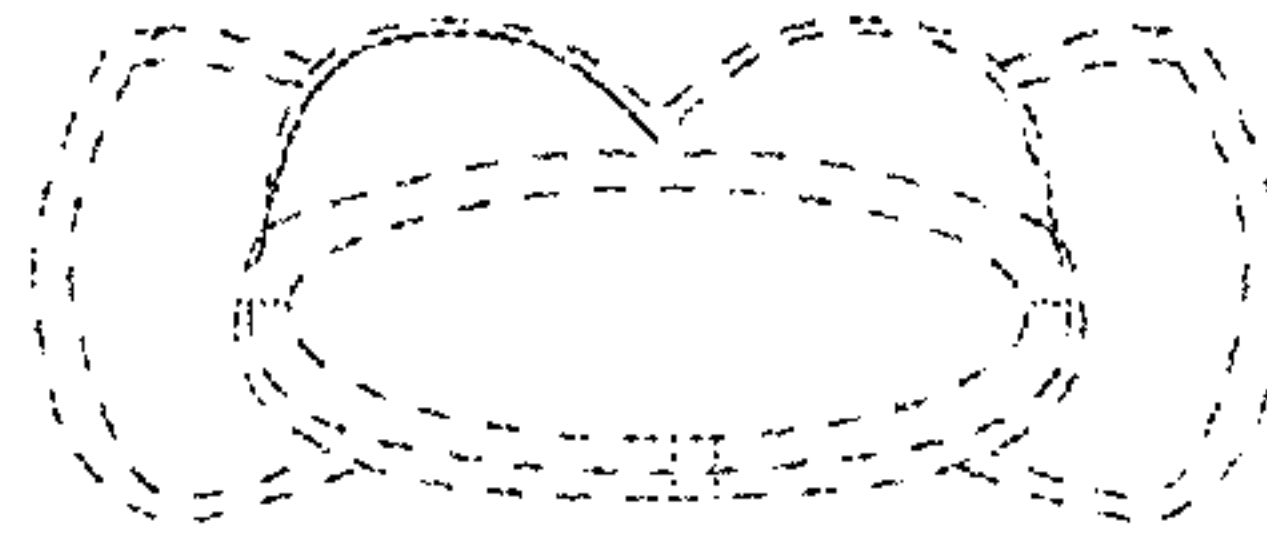

Fig. 20

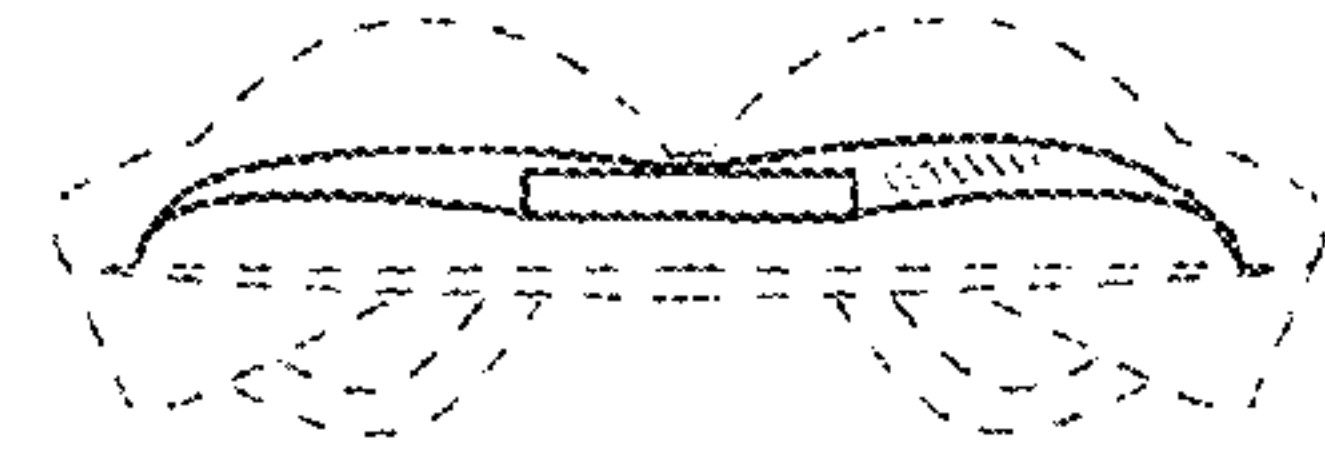

Fig. 21

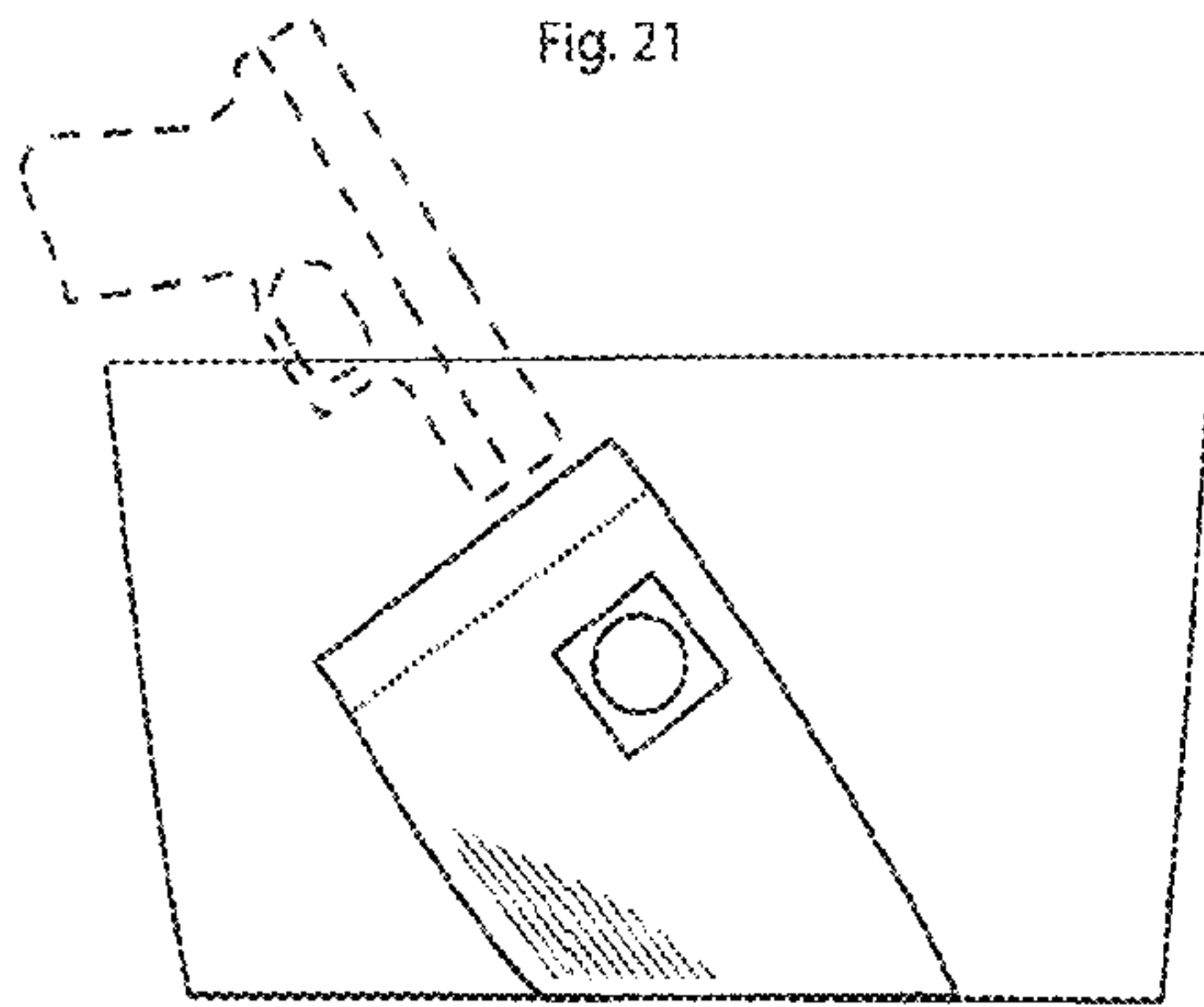

Fig. 22

