



US00D856492S

(12) **United States Design Patent**
Spangler

(10) **Patent No.:** **US D856,492 S**

(45) **Date of Patent:** **** Aug. 13, 2019**

(54) **FAUCET SPOUT**

(71) Applicant: **DELTA FAUCET COMPANY,**
Indianapolis, IN (US)

(72) Inventor: **Anthony G. Spangler,** Indianapolis, IN
(US)

(73) Assignee: **DELTA FAUCET COMPANY,**
Indianapolis, IN (US)

(**) Term: **15 Years**

(21) Appl. No.: **29/631,839**

(22) Filed: **Jan. 3, 2018**

(51) **LOC (12) Cl.** **23-01**

(52) **U.S. Cl.**
USPC **D23/257**

(58) **Field of Classification Search**
USPC D23/238-243, 249, 255, 257
See application file for complete search history.

(56) **References Cited**

U.S. PATENT DOCUMENTS

D461,230 S * 8/2002 Ko D23/255
D486,563 S * 2/2004 Hsieh D23/238

D488,539 S * 4/2004 McKeone D23/255
D713,937 S * 9/2014 Fritz D23/242
D810,888 S * 2/2018 Schoenherr D23/255
D818,564 S * 5/2018 Garland D23/255

* cited by examiner

Primary Examiner — Robert A Delehanty

(74) *Attorney, Agent, or Firm* — Edgar A. Zarins; Nirav
D. Parikh

(57) **CLAIM**

The ornamental design for a faucet spout, as shown and
described.

DESCRIPTION

FIG. 1 is a rear perspective view of a faucet spout showing
my new design;

FIG. 2 is a rear view thereof;

FIG. 3 is a front elevational view thereof;

FIG. 4 is a top plan view thereof;

FIG. 5 is a left side view thereof, the opposite side being a
mirror image of the side shown; and,

FIG. 6 is a bottom view thereof.

The broken-line disclosure in the view represents a portion
of the faucet spout in which the claimed design is embodied,
but which forms no part of the claimed design.

1 Claim, 2 Drawing Sheets

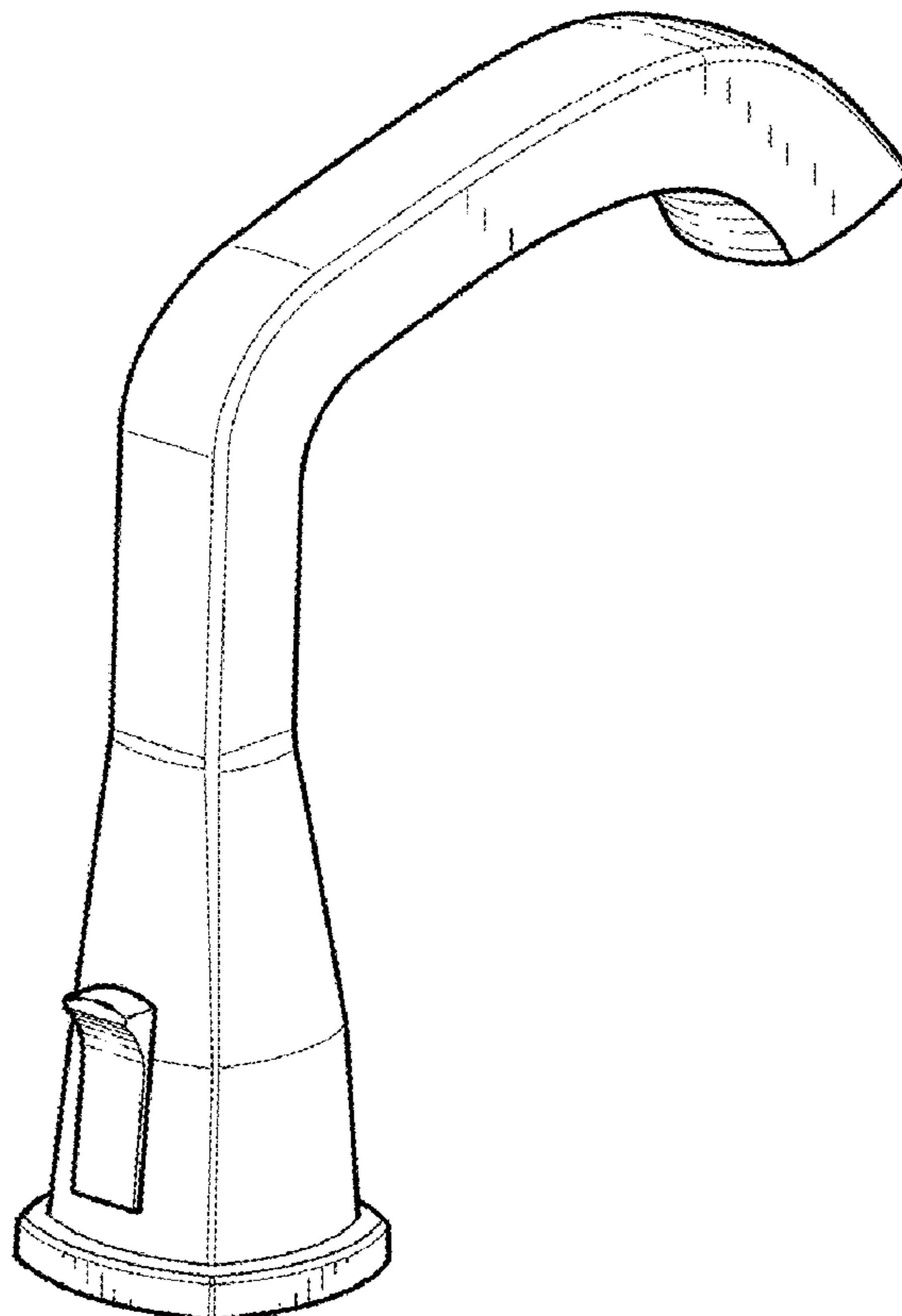

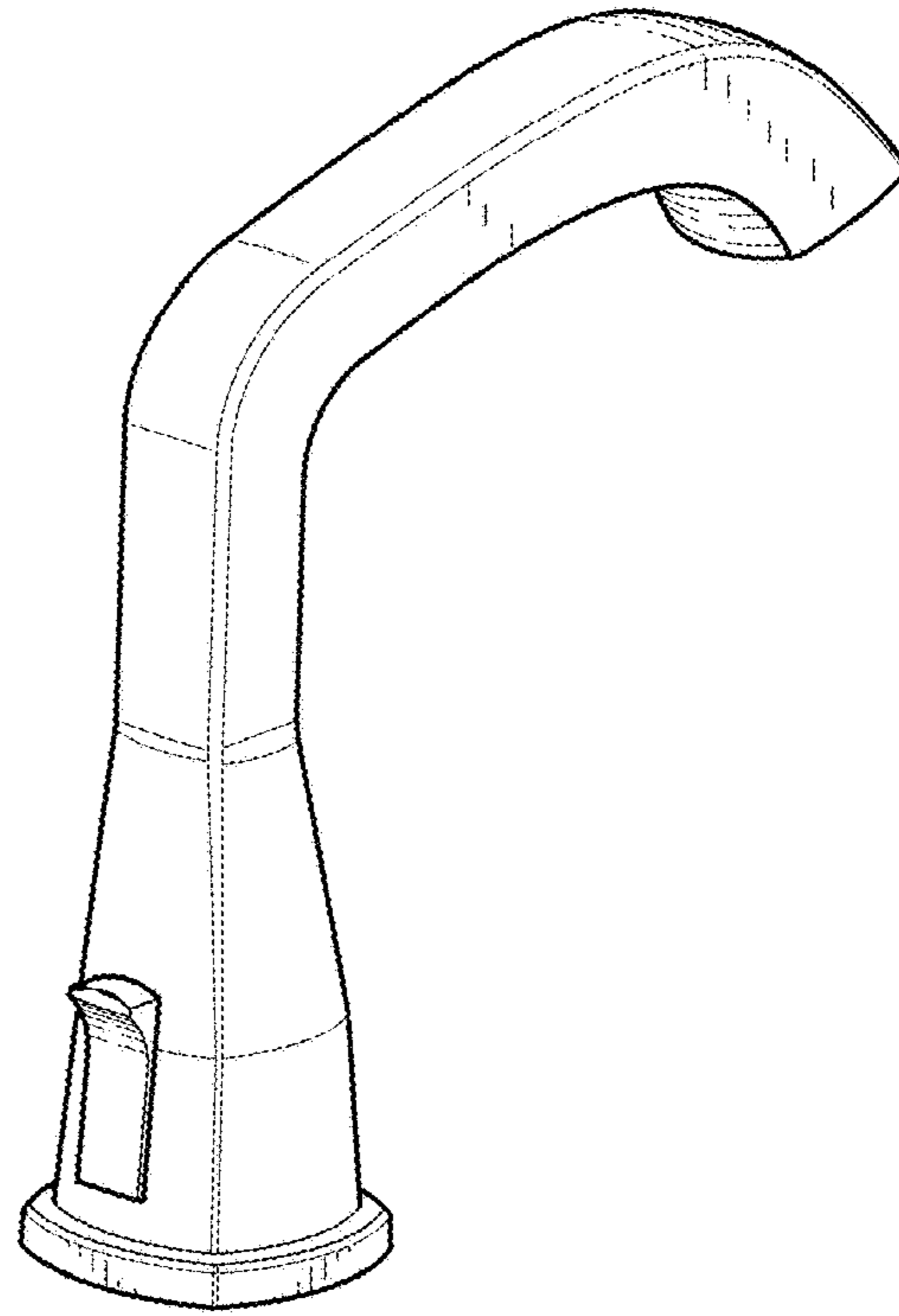

Fig-1

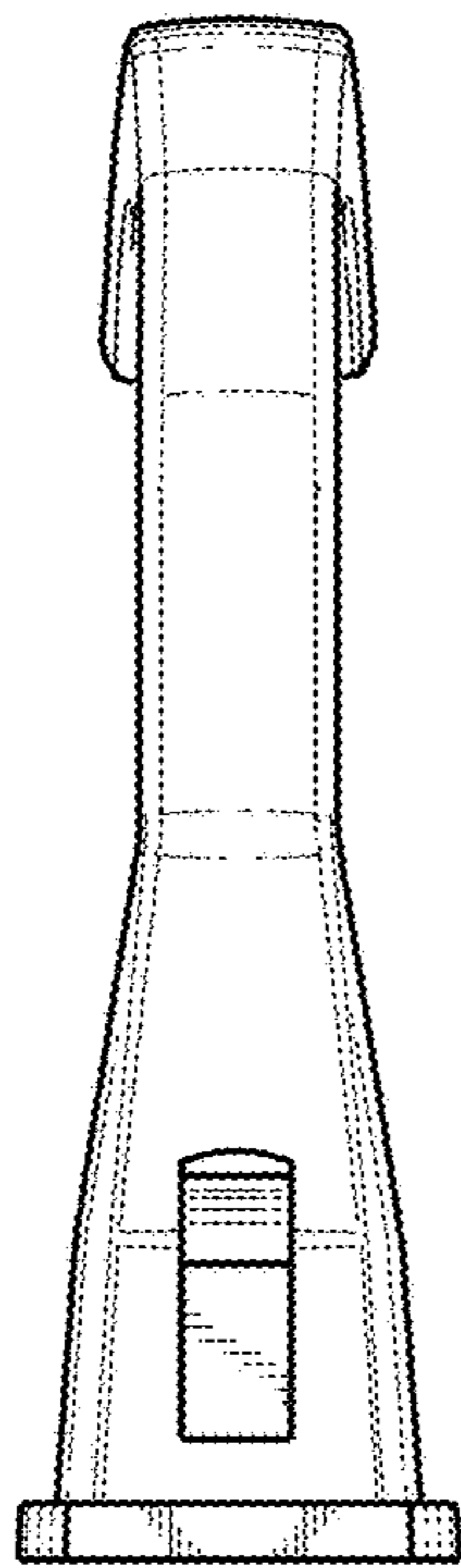

Fig-2

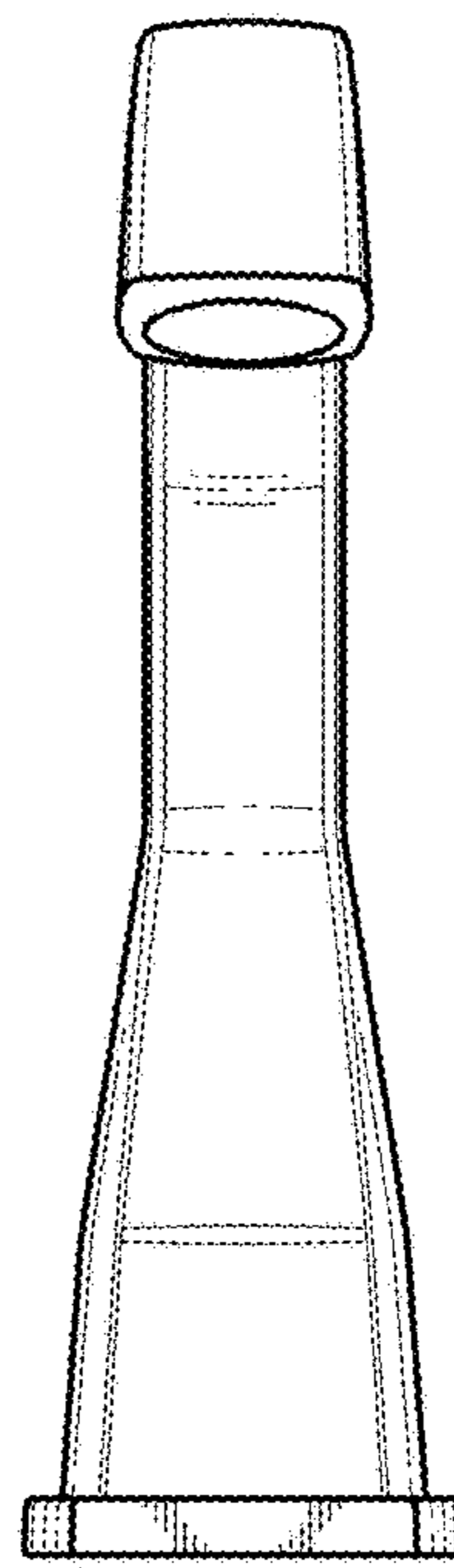

Fig-3

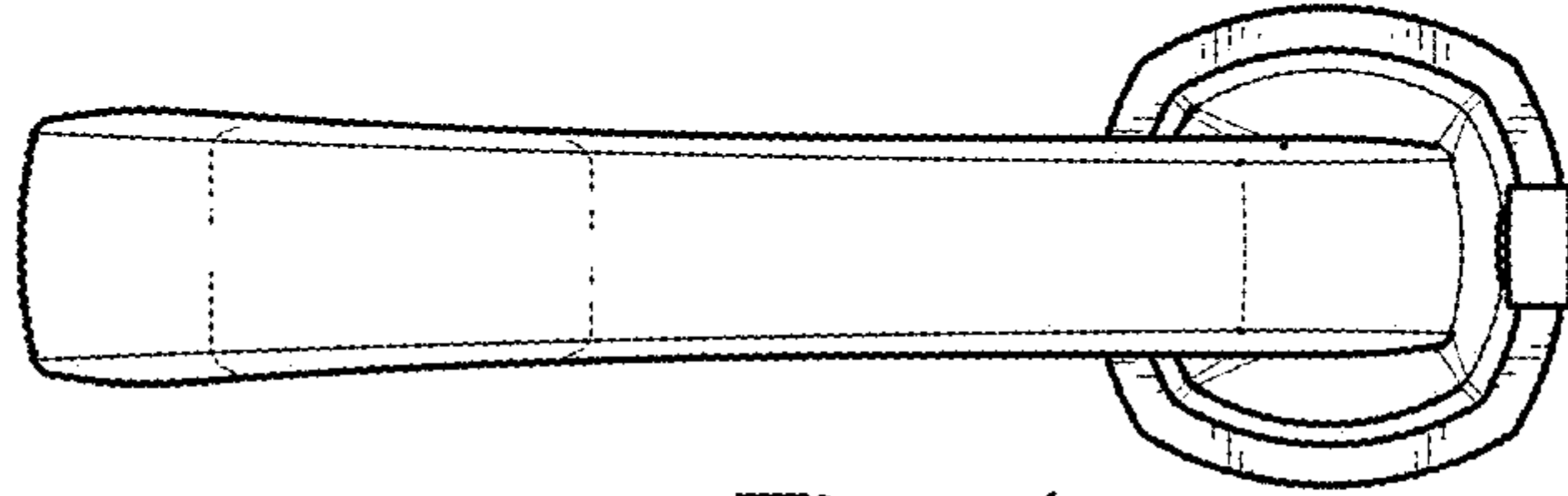

Fig-4

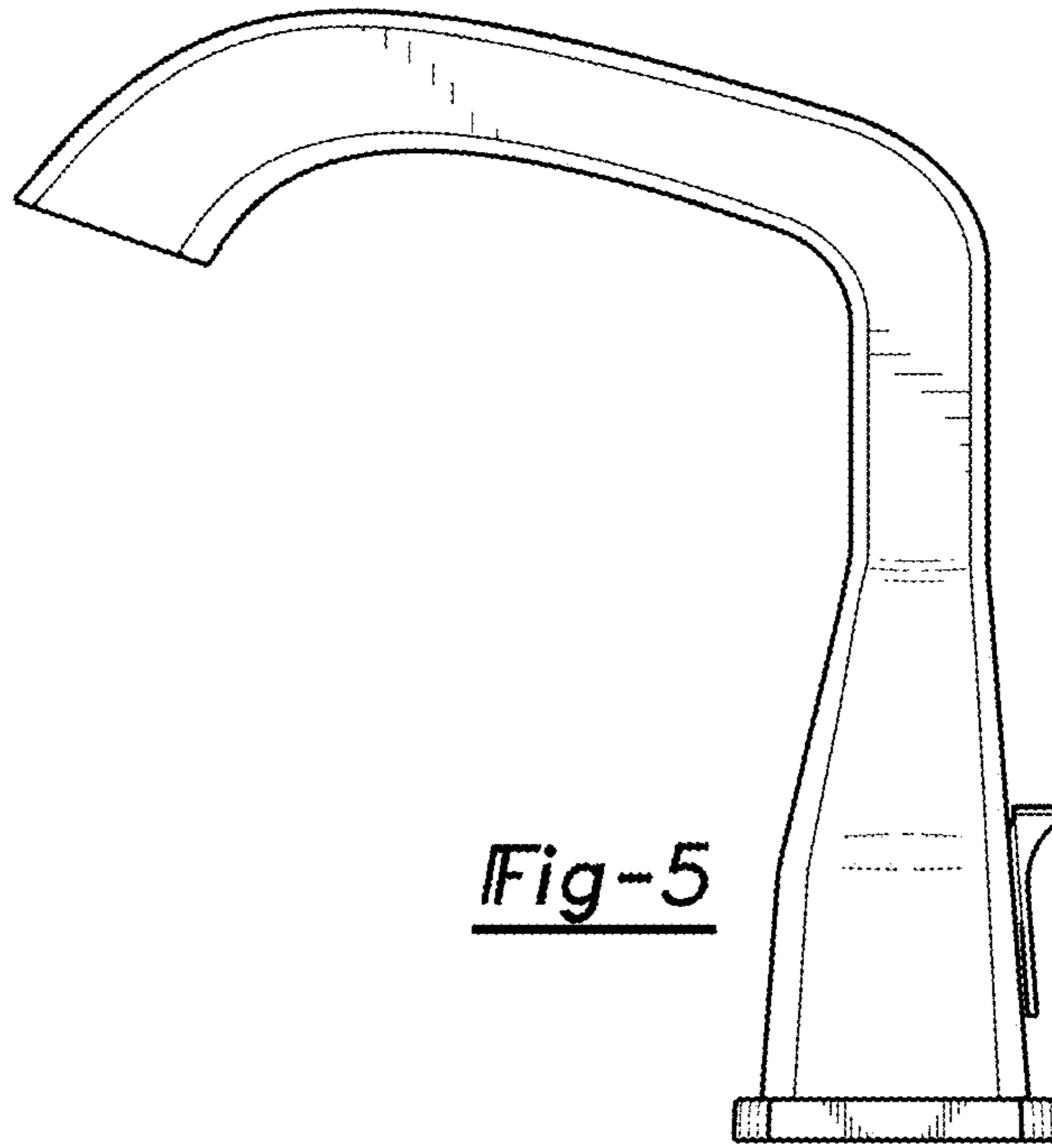

Fig-5

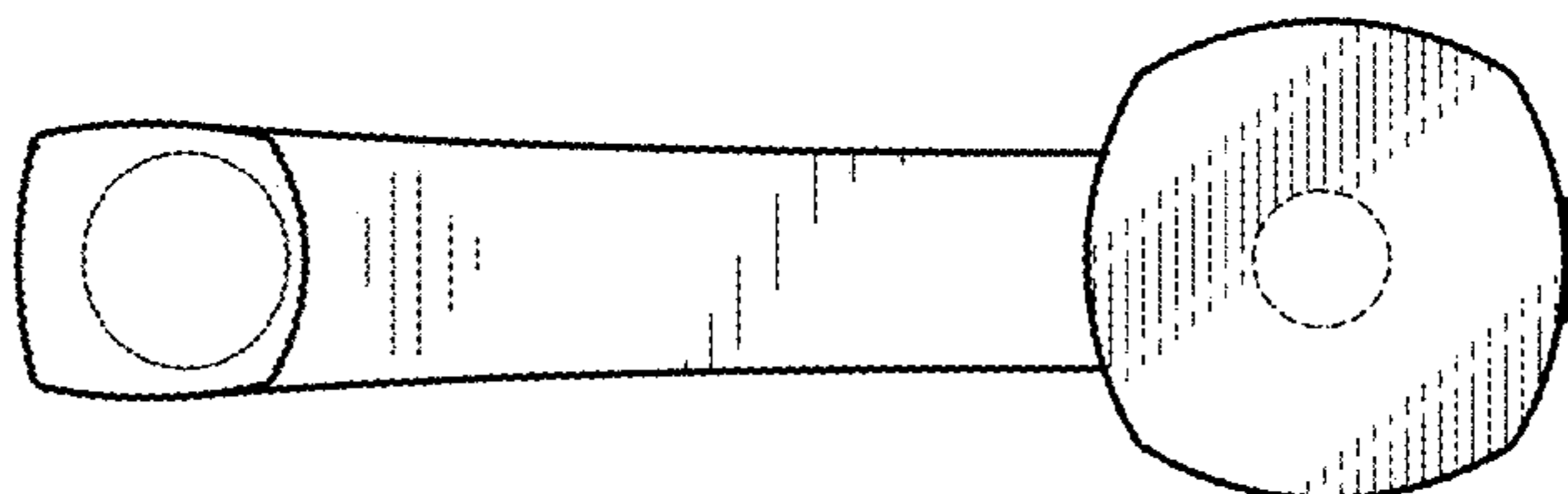

Fig-6