



US00D856487S

(12) **United States Design Patent**  
**Spangler**

(10) **Patent No.:** **US D856,487 S**

(45) **Date of Patent:** **\*\* Aug. 13, 2019**

(54) **FAUCET**

(71) Applicant: **DELTA FAUCET COMPANY,**  
Indianapolis, IN (US)

(72) Inventor: **Anthony G. Spangler,** Indianapolis, IN  
(US)

(73) Assignee: **DELTA FAUCET COMPANY,**  
Indianapolis, IN (US)

(\*\*) Term: **15 Years**

(21) Appl. No.: **29/631,796**

(22) Filed: **Jan. 3, 2018**

(51) **LOC (12) Cl.** ..... **23-01**

(52) **U.S. Cl.**  
USPC ..... **D23/242**

(58) **Field of Classification Search**  
USPC ..... D23/238-243, 249, 255, 257, 250, 252,  
D23/254; D8/307-308  
CPC ..... F16K 31/60; F16K 31/602; F16K 31/605;  
F16K 31/607; E03C 1/0412  
See application file for complete search history.

(56) **References Cited**

**U.S. PATENT DOCUMENTS**

D461,230 S \* 8/2002 Ko ..... D23/255  
D486,563 S \* 2/2004 Hsieh ..... D23/238  
D488,539 S \* 4/2004 McKeone ..... D23/255

D573,693 S \* 7/2008 Hsieh ..... D23/242  
D587,786 S \* 3/2009 Williams ..... D23/252  
D608,859 S \* 1/2010 Schoenherr ..... D23/242  
D611,573 S \* 3/2010 Gao ..... D23/252  
D648,830 S \* 11/2011 Corbett ..... D23/252  
D713,937 S \* 9/2014 Fritz ..... D23/242  
D729,350 S \* 5/2015 Bahler ..... D23/252  
D810,888 S \* 2/2018 Schoenherr ..... D23/255  
D820,403 S \* 6/2018 Garland ..... D23/239

\* cited by examiner

*Primary Examiner* — Robert A Delehanty

(74) *Attorney, Agent, or Firm* — Edgar A. Zarins; Nirav  
D. Parikh

(57) **CLAIM**

The ornamental design for a faucet, as shown and described.

**DESCRIPTION**

FIG. 1 is a rear perspective view of a faucet showing my new design;

FIG. 2 is a top plan view thereof;

FIG. 3 is a front elevational view thereof;

FIG. 4 is a rear view thereof;

FIG. 5 is a bottom view thereof; and,

FIG. 6 is a left side view thereof, the opposite side being a mirror image of the side shown.

The broken-line disclosure in the view represents a portion of the faucet in which the claimed design is embodied, but which forms no part of the claimed design.

**1 Claim, 3 Drawing Sheets**

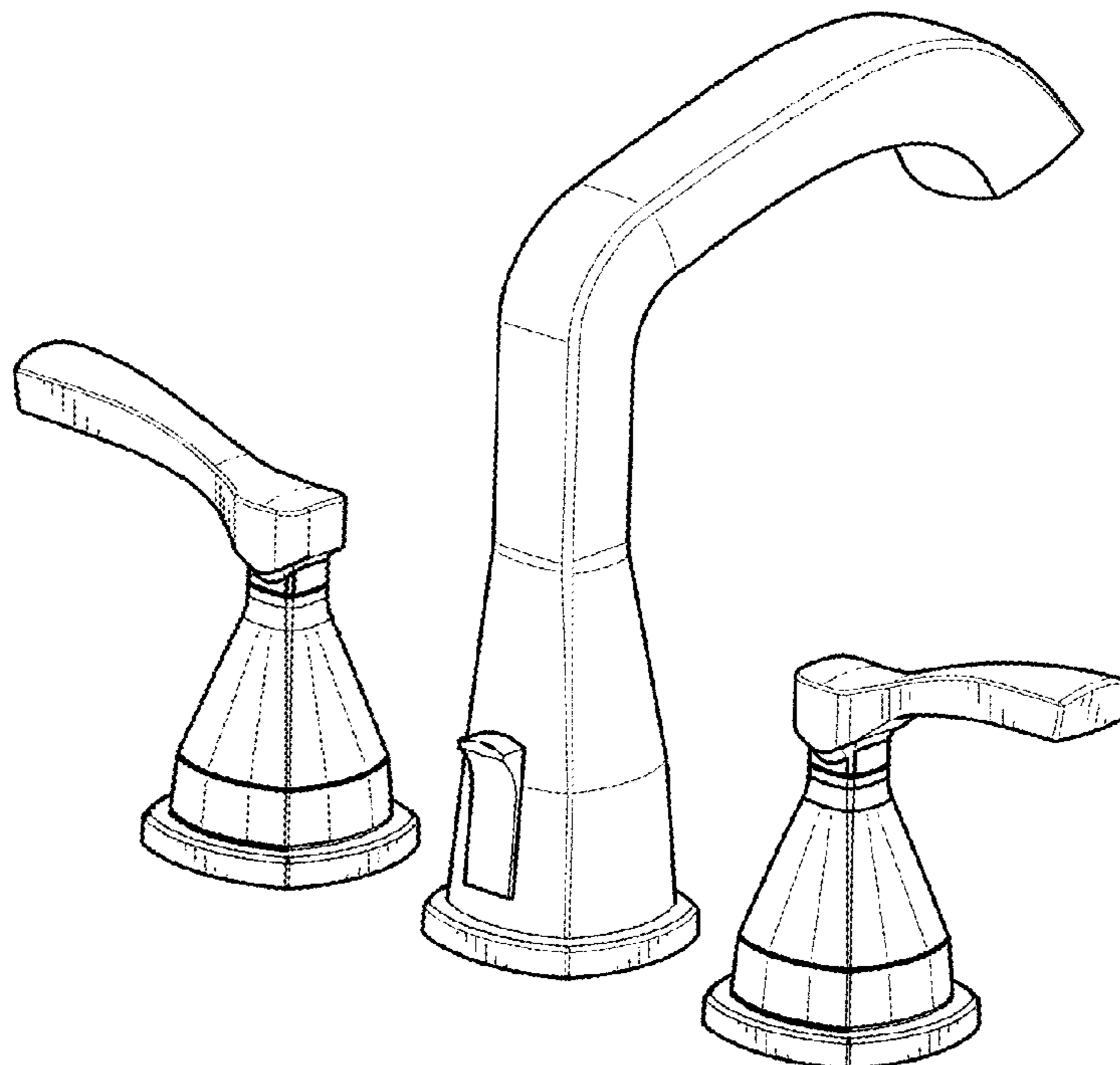

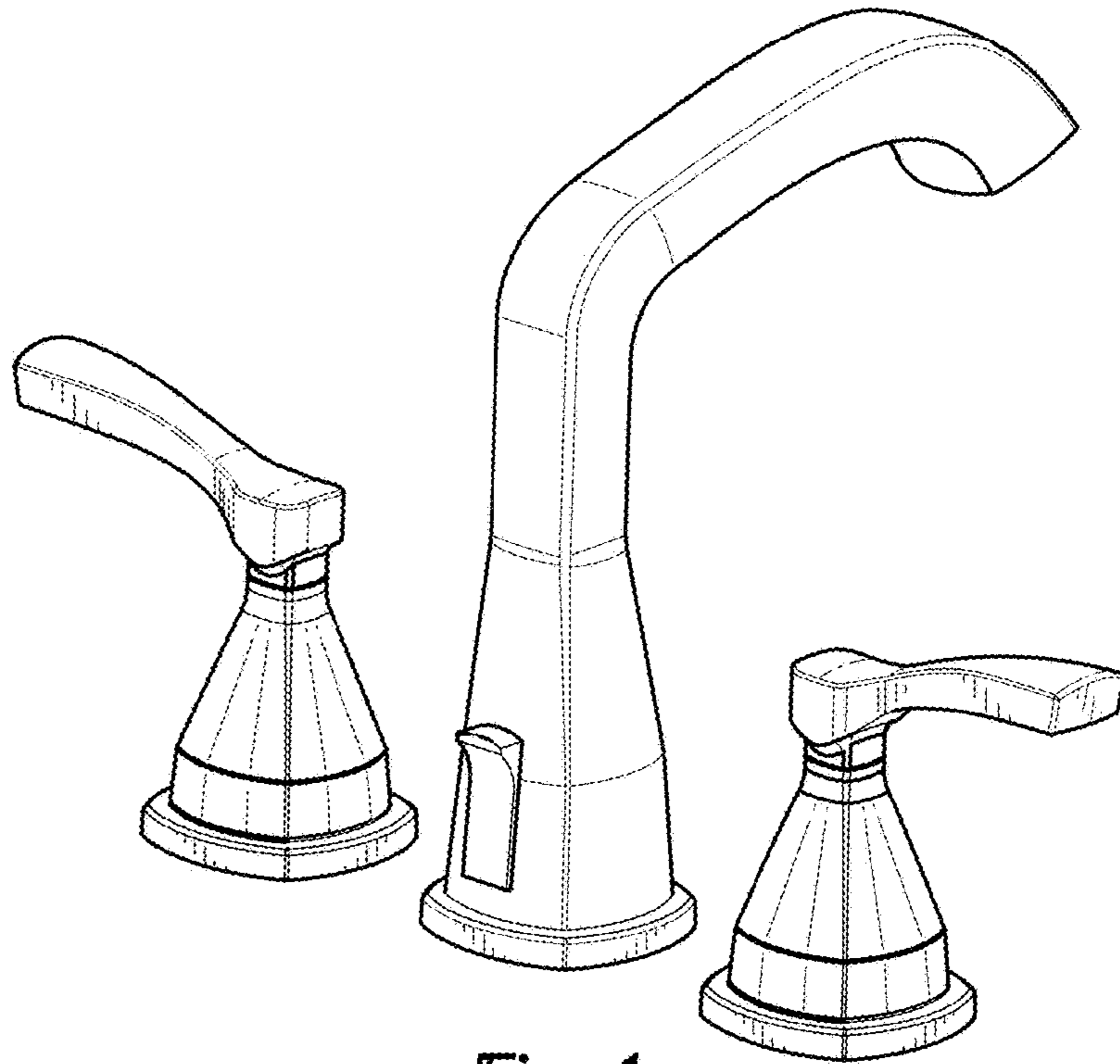

Fig-1

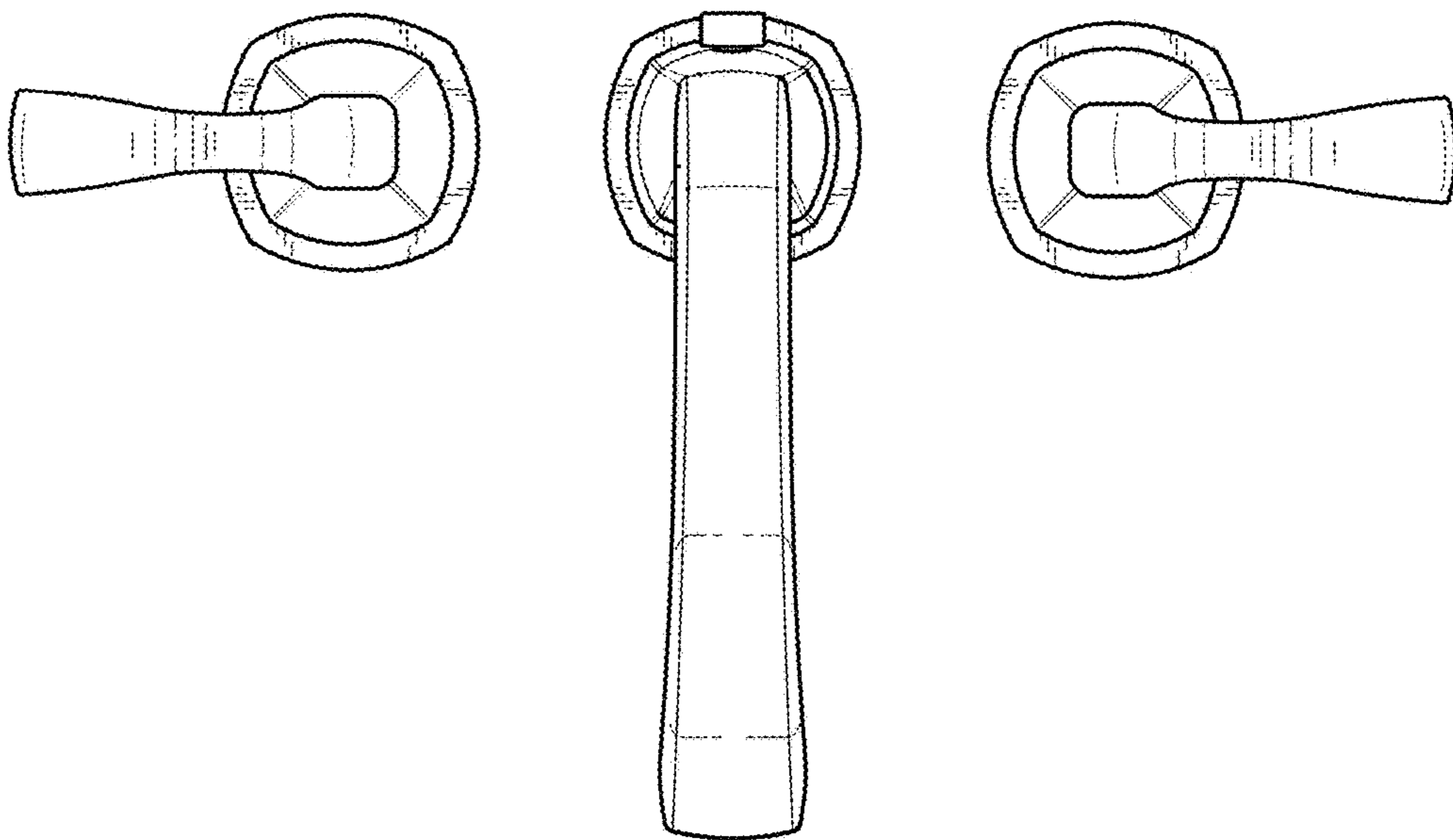

Fig-2

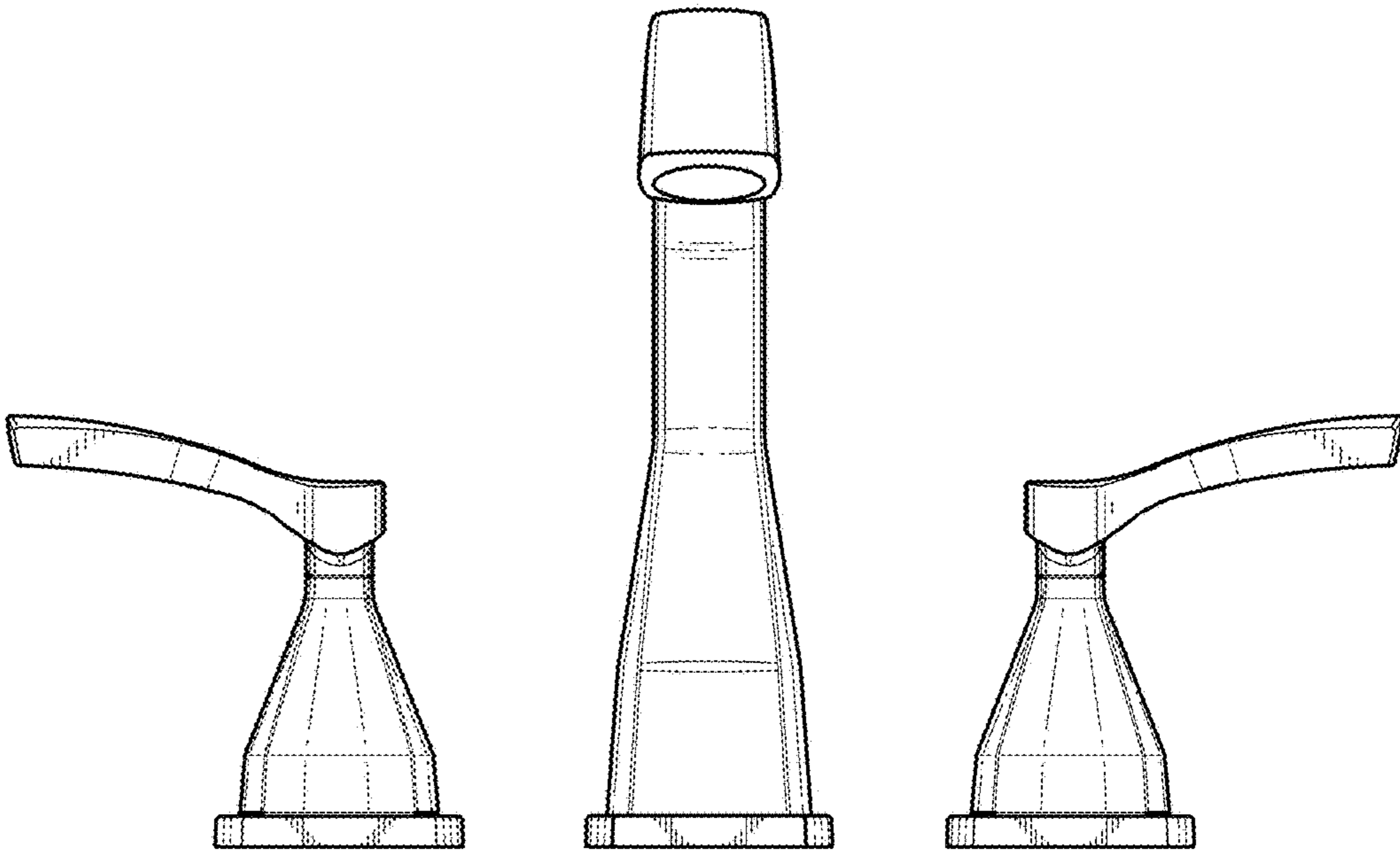

Fig-3

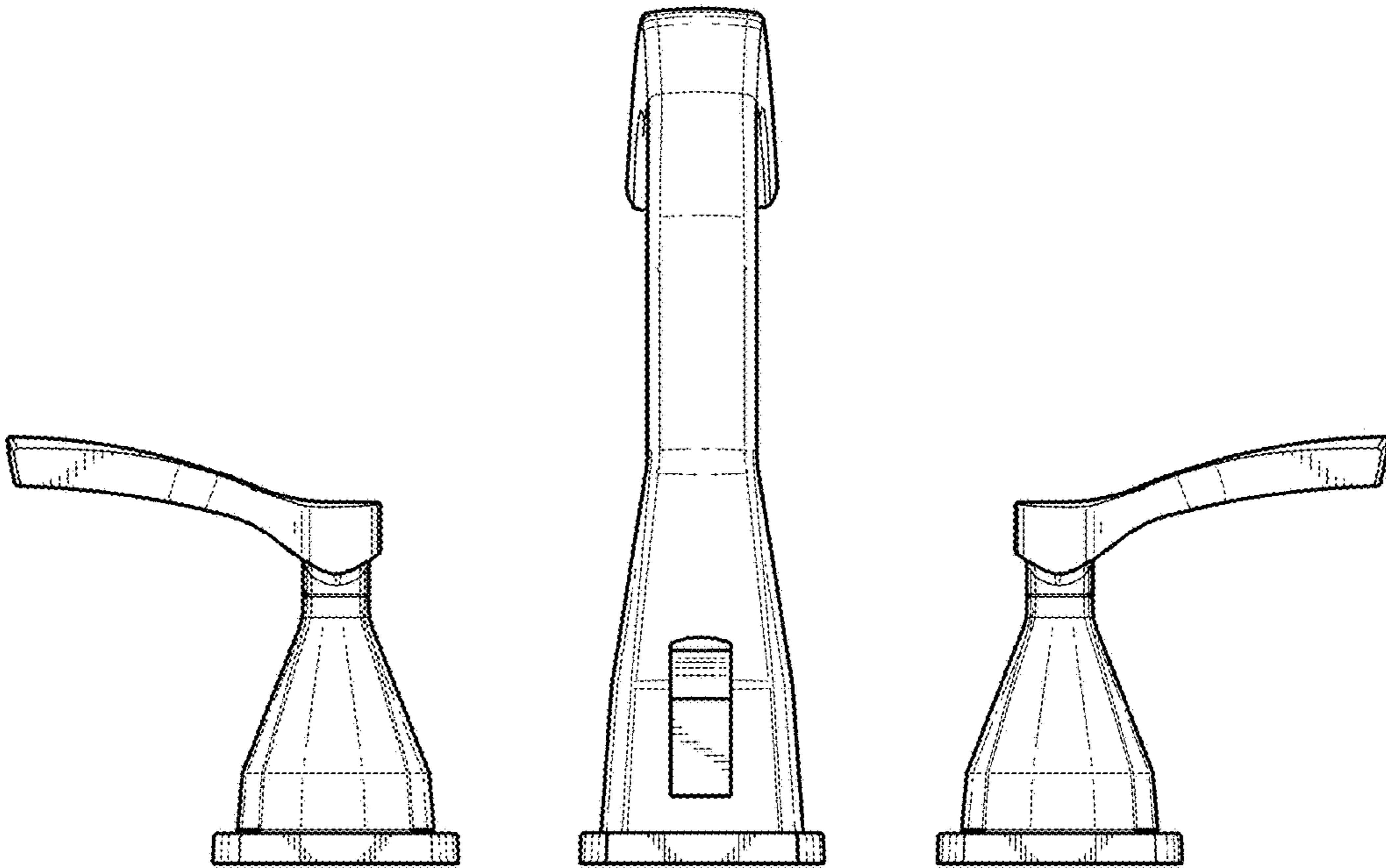

Fig-4

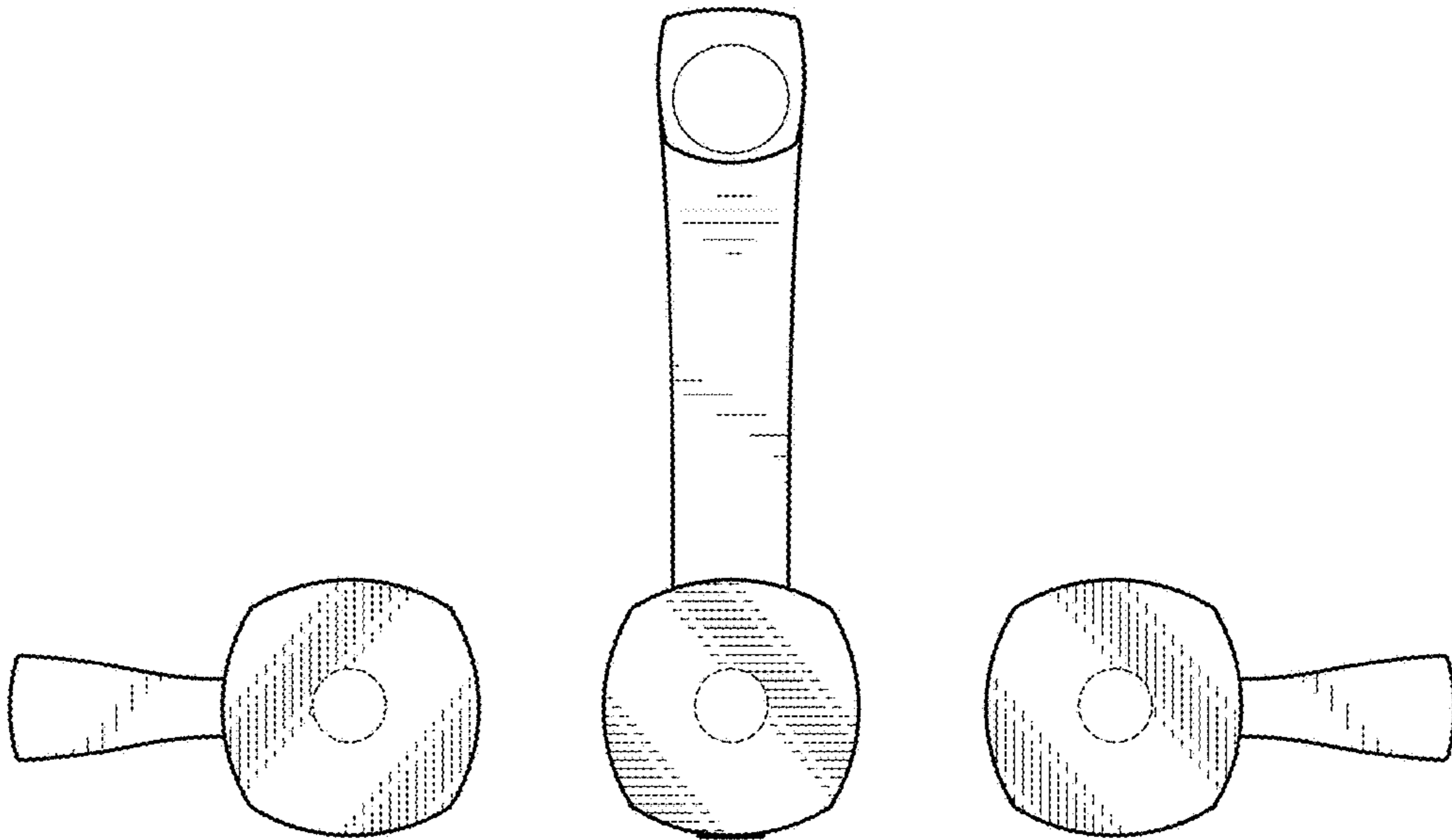

Fig-5

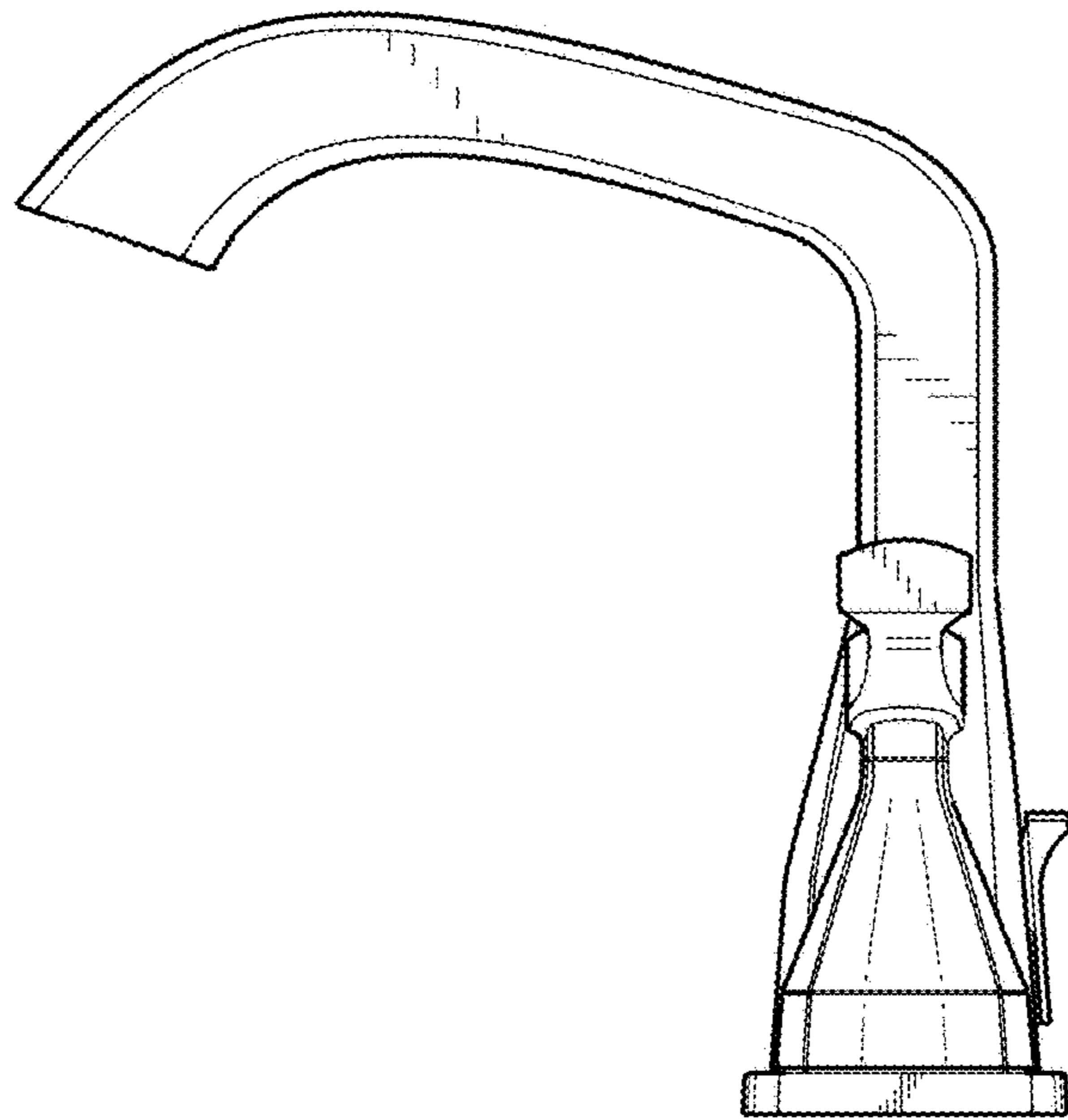

Fig-6