



US00D856451S

(12) **United States Design Patent** (10) **Patent No.:** **US D856,451 S**
Parsons et al. (45) **Date of Patent:** **** Aug. 13, 2019**

(54) **GOLF CLUB HEAD** D215,101 S 9/1969 Sabat
D234,963 S 4/1975 Hirata
(71) Applicant: **PARSONS XTREME GOLF, LLC,** D239,550 S 4/1976 Timbrook
Scottsdale, AZ (US) D240,054 S 5/1976 Meissler
D261,167 S 10/1981 Swanson
(72) Inventors: **Robert R. Parsons,** Scottsdale, AZ D294,617 S 3/1988 Perkins
(US); **Michael R. Nicolette,** Scottsdale, AZ 4,754,977 A 7/1988 Sahm
AZ (US); **Bradley D. Schweigert,** 4,824,116 A 4/1989 Nagamoto et al.
Anthem, AZ (US) 4,988,104 A 1/1991 Shiotani et al.
5,158,296 A * 10/1992 Lee A63B 53/04
473/327

(73) Assignee: **Parsons Xtreme Golf, LLC,** 5,176,384 A 1/1993 Sata et al.
Scottsdale, AZ (US) 5,213,328 A 5/1993 Long et al.
D336,672 S 6/1993 Gorman
D353,862 S 12/1994 Saito
(**) Term: **15 Years** D357,520 S 4/1995 Helmstetter et al.
5,419,560 A 5/1995 Bamber
(21) Appl. No.: **29/640,633** 5,425,535 A 6/1995 Gee
D361,358 S 8/1995 Simmons
(22) Filed: **Mar. 15, 2018** 5,447,311 A 9/1995 Viollaz et al.
5,451,056 A 9/1995 Manning
D362,884 S 10/1995 Blough et al.
D362,885 S 10/1995 Blough et al.
D362,887 S 10/1995 Blough et al.

Related U.S. Application Data

(63) Continuation-in-part of application No. 29/622,677, filed on Oct. 18, 2017, now abandoned, and a continuation-in-part of application No. 29/622,326, filed on Oct. 16, 2017, which is a continuation-in-part of application No. 29/618,845, filed on Sep. 25, 2017, now abandoned.

(51) **LOC (12) Cl.** **21-02**
(52) **U.S. Cl.**
USPC **D21/747**
(58) **Field of Classification Search**
USPC D21/747-751, 759
CPC A63B 53/00; A63B 53/02; A63B 53/04;
A63B 53/047; A63B 53/0475; A63B
2053/0479; A63B 2053/0483; A63B
2053/0445; A63B 60/00; A63B 60/46
See application file for complete search history.

D370,514 S 6/1996 Blough et al.
5,540,437 A 7/1996 Bamber
D379,106 S 5/1997 Maltby
5,637,045 A 6/1997 Igarashi
5,669,830 A 9/1997 Bamber
D389,541 S 1/1998 Huan-Chiang
D395,476 S 6/1998 Pond et al.
5,766,091 A 6/1998 Humphrey et al.
5,766,092 A 6/1998 Mimeur et al.
D399,277 S 10/1998 Ezaki
5,827,132 A 10/1998 Bamber
D408,485 S 4/1999 Takahashi et al.
5,899,821 A 5/1999 Hsu et al.
5,935,016 A 8/1999 Antonious
D414,535 S 9/1999 Mertens
D421,080 S 2/2000 Chen
D426,276 S 6/2000 Besnard et al.
D426,476 S 6/2000 Goss
6,077,171 A * 6/2000 Yoneyama A63B 53/04
473/291

D442,659 S 5/2001 Kubica et al.
D443,008 S 5/2001 Kubica et al.
D445,862 S 7/2001 Ford
6,290,609 B1 9/2001 Takeda
D449,866 S 10/2001 Miller
D457,211 S 5/2002 Bakke
D458,328 S 6/2002 Solheim et al.
D469,833 S 2/2003 Roberts et al.
D473,605 S 4/2003 Petersen et al.

(56) **References Cited**

U.S. PATENT DOCUMENTS

1,133,129 A 3/1915 Govan
D164,469 S 9/1951 Behrendt
3,020,048 A 2/1962 Carroll
D203,936 S 3/1966 Long

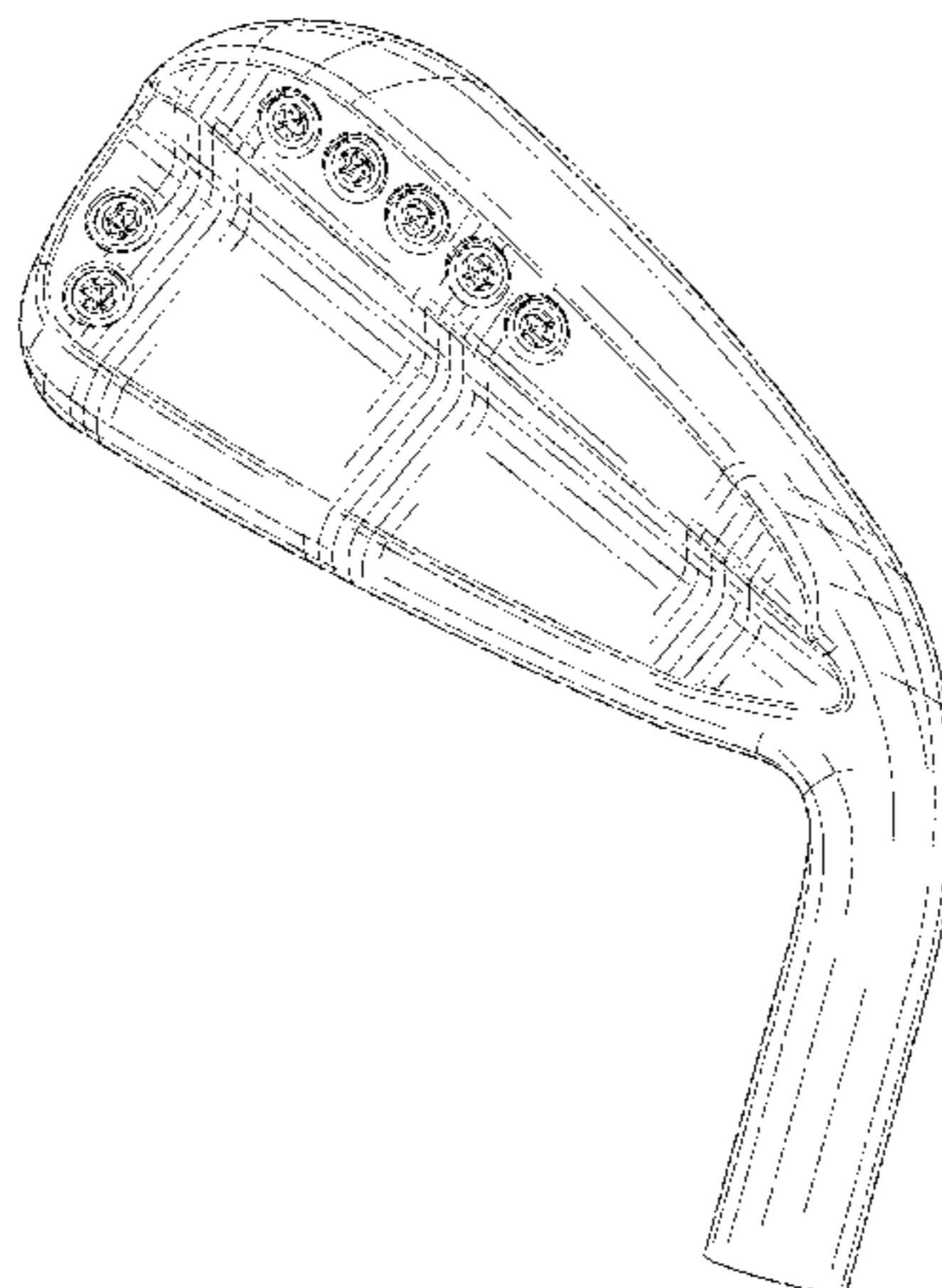

US D856,451 S

D475,107 S	5/2003	Madore		D596,688 S	7/2009	Schweigert et al.	
D476,048 S	6/2003	Cleveland et al.		D597,158 S	7/2009	Schweigert et al.	
D478,949 S	8/2003	DeLaCruz		D601,216 S	9/2009	Jertson et al.	
6,638,182 B2	10/2003	Kosmatka		7,588,502 B2	9/2009	Nishino	
6,695,714 B1	2/2004	Bliss et al.		7,601,075 B2	10/2009	Cole et al.	
6,702,693 B2	3/2004	Bamber		D604,783 S	11/2009	Nicolette et al.	
D492,376 S	6/2004	Nicolette et al.		7,611,424 B2	11/2009	Nagai et al.	
D494,240 S	8/2004	Schweigert		D606,605 S	12/2009	Wada et al.	
D494,648 S	8/2004	Schweigert et al.		D607,070 S	12/2009	Wada et al.	
6,780,123 B2	8/2004	Hasebe		D607,071 S	12/2009	Wada et al.	
D497,963 S	11/2004	Toulon et al.		7,658,686 B2	2/2010	Soracco	
6,811,496 B2	11/2004	Wahl et al.		D612,438 S	3/2010	Carlyle et al.	
D499,779 S	12/2004	Mahaffey et al.		D612,439 S	3/2010	Carlyle et al.	
D500,350 S	12/2004	Schweigert et al.		D617,406 S	6/2010	Carlyle et al.	
D500,351 S	12/2004	Schweigert et al.		D618,293 S	6/2010	Foster et al.	
D502,237 S	2/2005	Schweigert et al.		7,736,243 B2	6/2010	Sanchez et al.	
D502,975 S	3/2005	Schweigert et al.		7,744,484 B1	6/2010	Chao	
D503,204 S	3/2005	Nicolette et al.		D621,893 S	8/2010	Nicolette et al.	
D504,925 S	5/2005	Schweigert et al.		D621,894 S	8/2010	Schweigert	
D505,171 S	5/2005	Schweigert et al.		D621,895 S	8/2010	Schweigert et al.	
D507,320 S	7/2005	Roberts et al.		7,798,917 B2	9/2010	Nguyen et al.	
D507,614 S	7/2005	Schweigert et al.		7,815,521 B2	10/2010	Ban et al.	
D508,099 S	8/2005	Schweigert et al.		D627,409 S	11/2010	Schweigert et al.	
D508,545 S	8/2005	Roberts et al.		D627,410 S	11/2010	Nicolette et al.	
6,923,733 B2	8/2005	Chen		7,846,040 B2	12/2010	Ban	
D514,183 S	1/2006	Schweigert et al.		D633,159 S	2/2011	Holt	
D516,650 S	3/2006	Wolfe et al.		D633,967 S	3/2011	Carlyle et al.	
D518,863 S	4/2006	Motoyoshi et al.		D635,627 S	4/2011	Nicolette	
D523,501 S	6/2006	Nicolette et al.		7,938,738 B2	5/2011	Roach	
D523,917 S	6/2006	Wolfe et al.		D642,642 S	8/2011	Jertson et al.	
D524,889 S	7/2006	Yu et al.		D643,488 S	8/2011	Holt	
D530,759 S	10/2006	Nicolette et al.		D643,490 S	8/2011	Wada et al.	
D530,760 S	10/2006	Schweigert et al.		D643,491 S	8/2011	Stokke et al.	
7,121,956 B2	10/2006	Lo		D643,492 S	8/2011	Nicolette et al.	
7,128,663 B2	10/2006	Bamber		D643,895 S	8/2011	Wieland	
D532,849 S	11/2006	Nicolette et al.		D643,896 S	8/2011	Jertson et al.	
D534,228 S	12/2006	Nicolette et al.		D647,582 S	10/2011	Nicolette et al.	
D534,595 S	1/2007	Hasebe		D649,211 S	11/2011	Jertson et al.	
D534,597 S	1/2007	Nicolette et al.		8,062,150 B2	11/2011	Gilbert et al.	
7,156,751 B2	1/2007	Wahl et al.		D651,268 S	12/2011	Nicolette et al.	
D536,759 S	2/2007	Schweigert et al.		8,088,025 B2	1/2012	Wahl et al.	
D537,494 S	2/2007	Jertson et al.		8,092,319 B1	1/2012	Cackett et al.	
7,182,698 B2	2/2007	Tseng		8,105,180 B1	1/2012	Cackett et al.	
D538,366 S	3/2007	Nicolette et al.		8,142,307 B2	3/2012	Sanchez et al.	
D539,864 S	4/2007	Nicolette et al.		D658,248 S	4/2012	Nunez et al.	
D540,898 S	4/2007	Solheim et al.		8,221,262 B1	7/2012	Cackett et al.	
D541,360 S	4/2007	Schweigert et al.		8,246,487 B1	8/2012	Cackett et al.	
7,207,900 B2	4/2007	Nicolette et al.		D670,775 S	11/2012	Jertson et al.	
D543,601 S *	5/2007	Kawami	D21/759	D672,417 S	12/2012	Jertson et al.	
D544,056 S	6/2007	Nicolette et al.		8,328,662 B2	12/2012	Nakamura et al.	
D547,410 S	7/2007	Nicolette et al.		D673,633 S	1/2013	Jertson et al.	
D555,219 S *	11/2007	Lin	D21/759	D673,634 S	1/2013	Jertson et al.	
7,303,486 B2	12/2007	Imamoto		8,376,878 B2	2/2013	Bennett et al.	
D559,932 S	1/2008	Belmont		D680,603 S	4/2013	Nicolette et al.	
D561,855 S	2/2008	Schweigert et al.		D681,142 S	4/2013	Fossum et al.	
D562,925 S	2/2008	Schweigert et al.		D681,143 S	4/2013	Nicolette et al.	
7,351,164 B2	4/2008	Schweigert et al.		8,414,422 B2	4/2013	Peralta et al.	
D570,435 S	6/2008	Sanchez et al.		8,506,420 B2	8/2013	Hocknell et al.	
D570,935 S	6/2008	Nicolette et al.		8,545,343 B2	10/2013	Boyd et al.	
D570,936 S	6/2008	Schweigert et al.		8,574,094 B2	11/2013	Nicolette et al.	
D570,942 S	6/2008	Chen et al.		8,657,700 B2	2/2014	Nicolette et al.	
D571,422 S	6/2008	Schweigert et al.		8,663,026 B2	3/2014	Blowers et al.	
D571,425 S	6/2008	Chen et al.		8,690,710 B2	4/2014	Nicolette et al.	
D571,427 S	6/2008	Schweigert et al.		D707,316 S	6/2014	Aguayo et al.	
D571,881 S	6/2008	Nicolette et al.		D707,317 S	6/2014	Aguayo et al.	
D572,326 S	7/2008	Schweigert et al.		8,753,230 B2	6/2014	Stokke et al.	
D572,329 S	7/2008	Nicolette et al.		D708,688 S	7/2014	Nicolette et al.	
D573,219 S	7/2008	Schweigert et al.		8,827,832 B2	9/2014	Breier et al.	
7,396,299 B2	7/2008	Nicolette et al.		8,827,833 B2	9/2014	Amano et al.	
7,413,518 B2	8/2008	Cole et al.		8,845,455 B2	9/2014	Ban et al.	
D577,783 S	9/2008	Schweigert et al.		D716,387 S	10/2014	Aguayo et al.	
D578,590 S	10/2008	Schweigert et al.		D716,388 S	10/2014	Aguayo et al.	
D581,000 S	11/2008	Nicolette et al.		D722,352 S *	2/2015	Nicolette	D21/747
D581,004 S	11/2008	Schweigert et al.		D723,120 S *	2/2015	Nicolette	D21/747
D584,370 S	1/2009	Cleveland et al.		8,961,336 B1 *	2/2015	Parsons	A63B 53/0475 473/332
D594,518 S	6/2009	Schweigert					
D596,256 S	7/2009	Schweigert et al.		D726,265 S *	4/2015	Nicolette	D21/747
D596,257 S	7/2009	Jertson et al.		9,199,143 B1	12/2015	Parsons et al.	
D596,258 S	7/2009	Jertson et al.		D746,926 S *	1/2016	Parsons	D21/747

D748,214	S *	1/2016	Nicolette	D21/747
D748,749	S *	2/2016	Nicolette	D21/759
D751,660	S *	3/2016	Greenlaw	D21/759
D756,471	S *	5/2016	Nicolette	D21/747
D764,610	S	8/2016	Parsons et al.	
9,421,437	B2	8/2016	Parsons et al.	
9,427,634	B2	8/2016	Parsons et al.	
D773,575	S *	12/2016	Nicolette	D21/747
D802,068	S *	11/2017	Parsons	D21/747
D816,787	S *	5/2018	Nicolette	D21/747
D827,065	S *	8/2018	Nicolette	D21/747
D835,737	S *	12/2018	Parsons	D21/747
2002/0107087	A1	8/2002	Fagot	
2003/0139226	A1 *	7/2003	Cheng	A63B 53/04 473/334
2003/0176231	A1	9/2003	Hasebe	
2004/0204263	A1	10/2004	Fagot et al.	
2005/0009632	A1	1/2005	Schweigert et al.	
2005/0014573	A1	1/2005	Lee	
2005/0096148	A1	5/2005	Noble et al.	
2005/0119066	A1	6/2005	Stites et al.	
2005/0239569	A1	10/2005	Best et al.	
2005/0277485	A1 *	12/2005	Hou	A63B 53/047 473/332
2006/0111200	A1	5/2006	Poynor	
2007/0032308	A1	2/2007	Fagot et al.	
2007/0225084	A1	9/2007	Schweigert et al.	
2008/0058113	A1	3/2008	Nicolette et al.	
2008/0188322	A1	3/2008	Anderson et al.	
2008/0300065	A1	12/2008	Schweigert	
2009/0029790	A1	1/2009	Nicolette et al.	
2010/0130306	A1	5/2010	Schweigert	
2010/0178999	A1	7/2010	Nicolette et al.	
2011/0111883	A1	5/2011	Cackett	
2011/0165963	A1	7/2011	Cackett et al.	
2011/0269567	A1	11/2011	Ban et al.	
2011/0294596	A1	12/2011	Ban	
2013/0137532	A1	5/2013	Deshmukh et al.	
2013/0225319	A1	8/2013	Kato	
2013/0281226	A1	10/2013	Ban	
2013/0288823	A1	10/2013	Hebreo	
2013/0303303	A1	11/2013	Ban	
2013/0310192	A1	11/2013	Wahl et al.	
2014/0080621	A1	3/2014	Nicolette et al.	
2014/0128175	A1	5/2014	Jertson et al.	
2014/0274441	A1	9/2014	Greer	
2014/0274451	A1	9/2014	Knight et al.	
2015/0231454	A1 *	8/2015	Parsons	A63B 53/0475 473/335
2015/0231806	A1 *	8/2015	Parsons	B29C 45/14467 264/261

OTHER PUBLICATIONS

International Search Report and Written Opinion issued in connection with corresponding application No. PCT/US2015/016666, dated May 14, 2015 (8 pages).

Kozuchowski, Zak; "Callaway Mack Daddy 2 PM Grind Wedges" (<http://www.golfwrx.com/276203/callaway-mack-daddy-2-pm-grind-wedges/>), www.golfwrx.com, GolfWRX Holdings, LLC, published Jan. 21, 2015.

Wall, Jonathan, "Details: Phil's Prototype Mack Daddy PM-Grind Wedge," (<http://www.pgatour.com/equipmentreport/2015/01/21/callaway-wedge.html>), www.pgatour.com, PGA Tour, Inc., published Jan. 21, 2015.

* cited by examiner

Primary Examiner — Mitchell I. Siegel

(57)

CLAIM

The ornamental design for a golf club head, as shown and described.

DESCRIPTION

FIG. 1 is a top perspective view of a golf club head; FIG. 2 is a rear perspective view of the golf club head of FIG. 1; FIG. 3 is a front elevational view of the golf club head of FIG. 1; FIG. 4 is a rear elevational view of the golf club head of FIG. 1; FIG. 5 is a top view of the golf club head of FIG. 1; FIG. 6 is a bottom view of the golf club head of FIG. 1; FIG. 7 is a left side view of the golf club head of FIG. 1; FIG. 8 is a right side view of the golf club head of FIG. 1; FIG. 9 is a top perspective view of a second embodiment of a golf club head; FIG. 10 is a rear perspective view of the golf club head of FIG. 9; FIG. 11 is a front elevational view of the golf club head of FIG. 9; FIG. 12 is a rear elevational view of the golf club head of FIG. 9; FIG. 13 is a top view of the golf club head of FIG. 9; FIG. 14 is a bottom view of the golf club head of FIG. 9; FIG. 15 is a left side view of the golf club head of FIG. 9; FIG. 16 is a right side view of the golf club head of FIG. 9; FIG. 17 is a top perspective view of a third embodiment of a golf club head; FIG. 18 is a rear perspective view of the golf club head of FIG. 17; FIG. 19 is a front elevational view of the golf club head of FIG. 17; FIG. 20 is a rear elevational view of the golf club head of FIG. 17; FIG. 21 is a top view of the golf club head of FIG. 17; FIG. 22 is a bottom view of the golf club head of FIG. 17; FIG. 23 is a left side view of the golf club head of FIG. 17; and, FIG. 24 is a right side view of the golf club head of FIG. 17. The broken line showing is included for the purpose of illustrating unclaimed subject matter and forms no part of the claimed design.

1 Claim, 24 Drawing Sheets

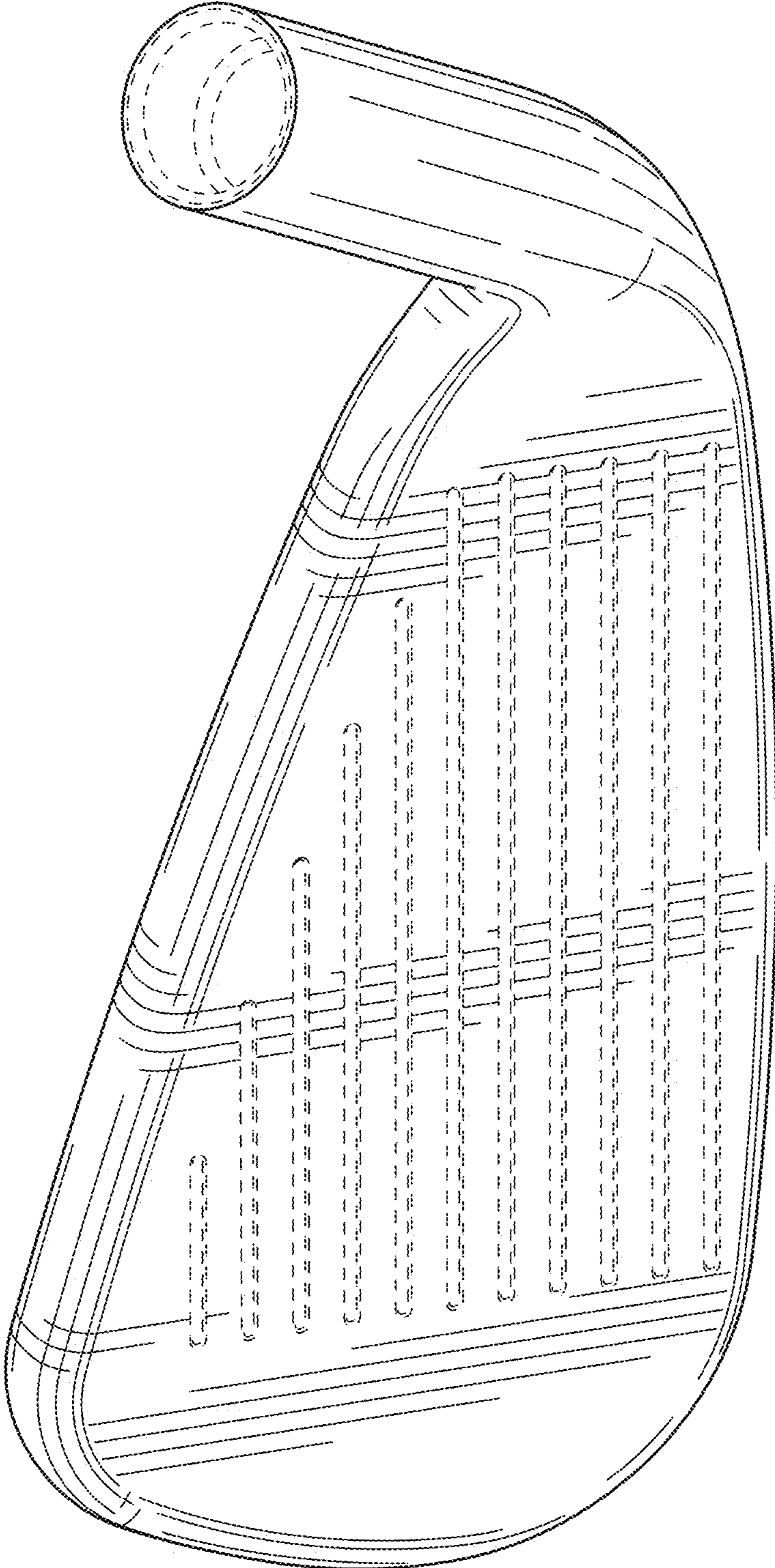

FIG. 1

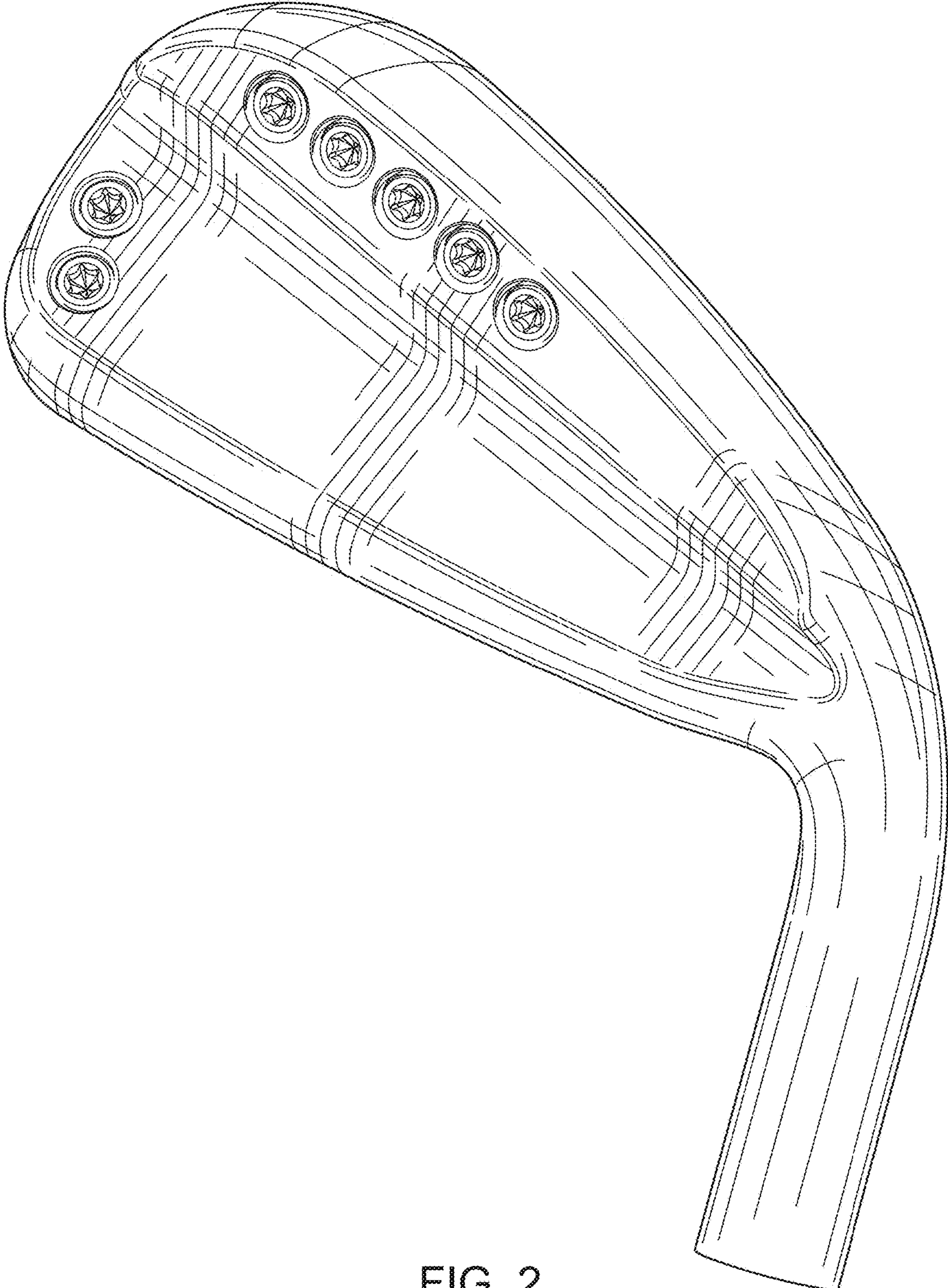

FIG. 2

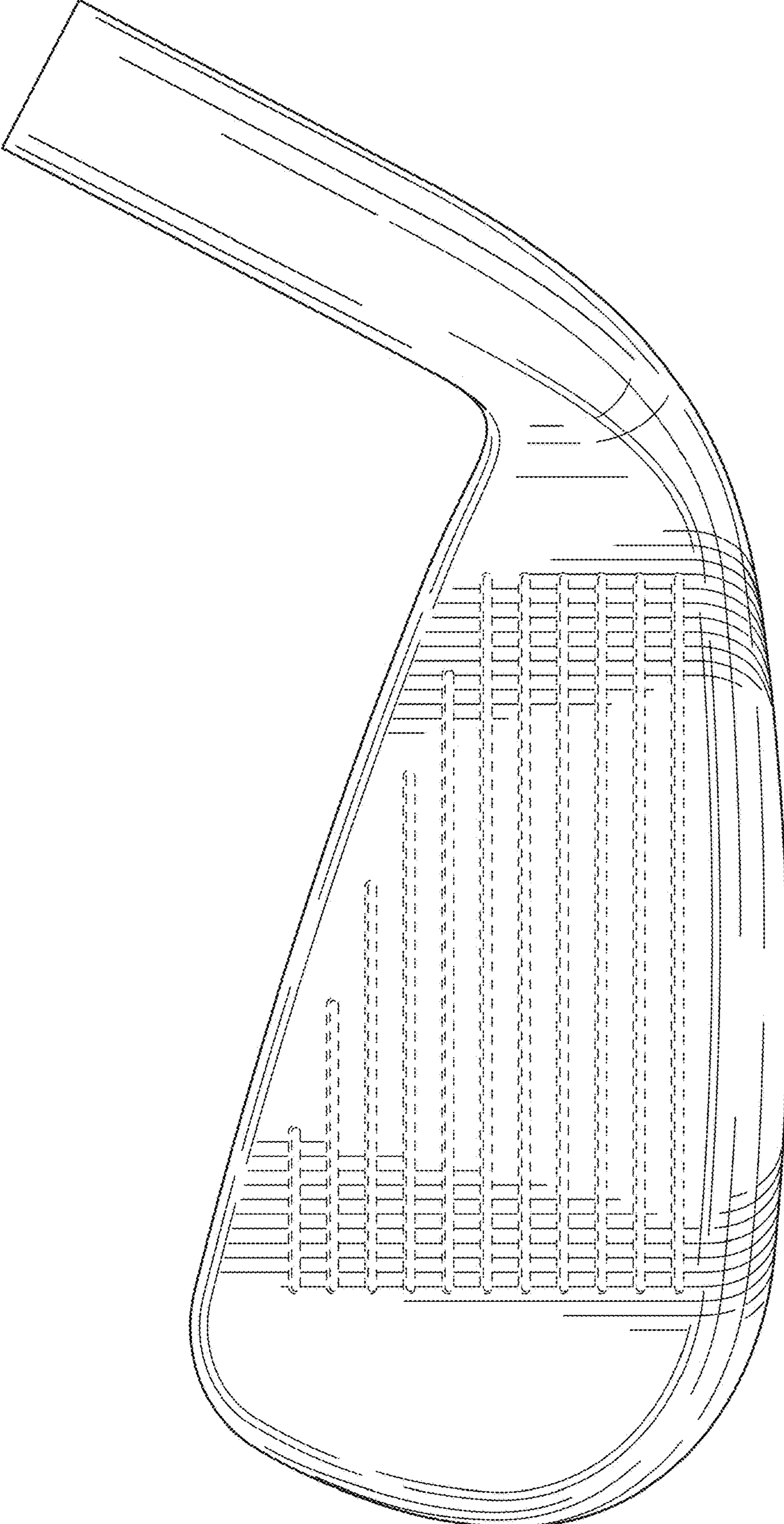

FIG. 3

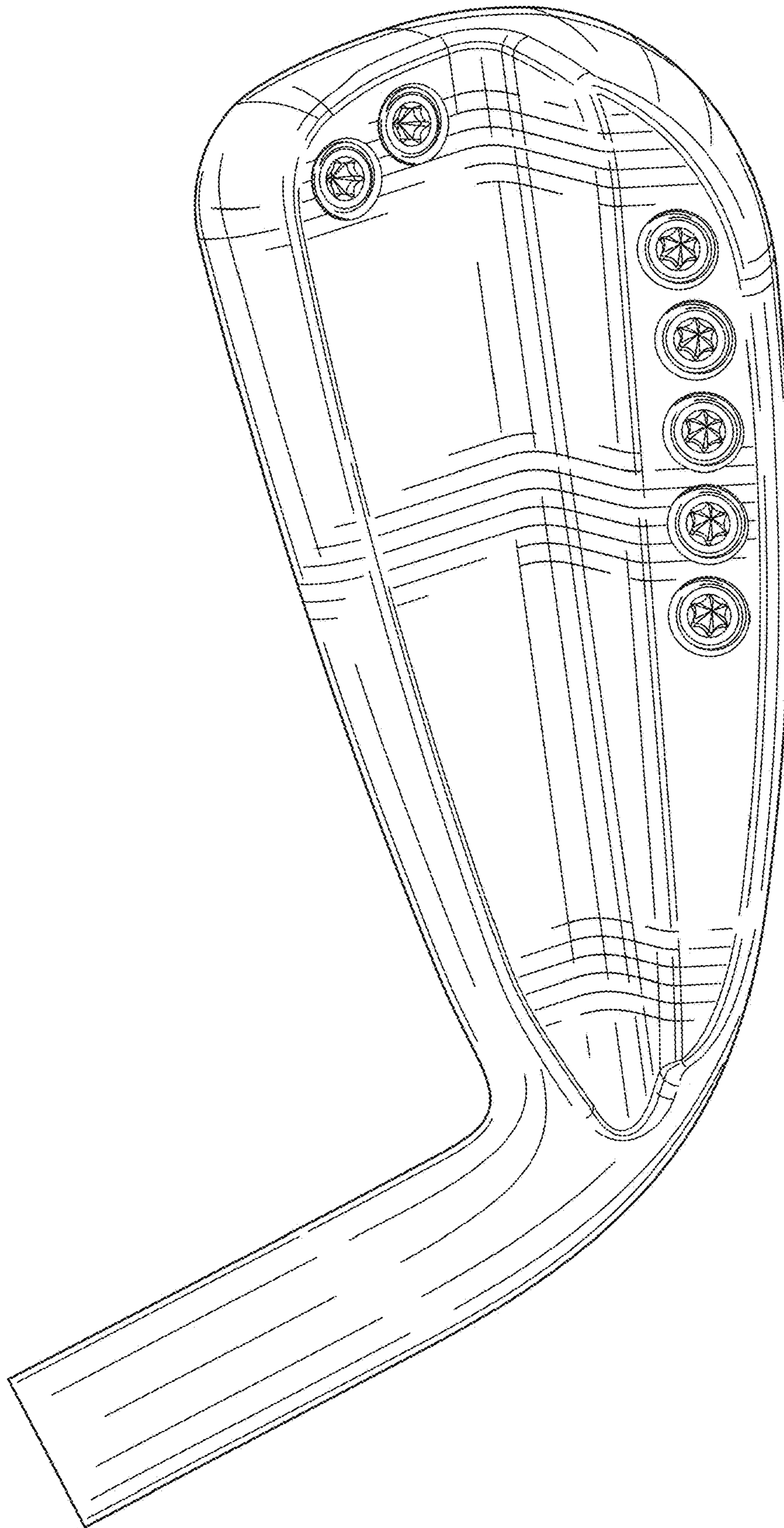

FIG. 4

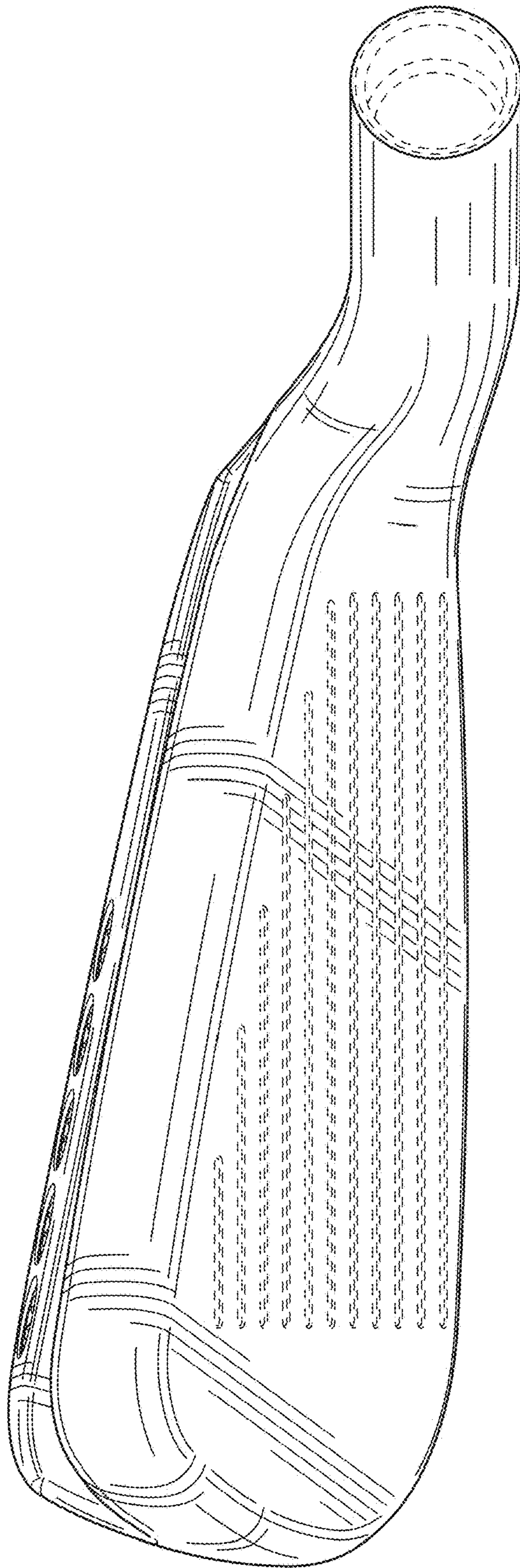

FIG. 5

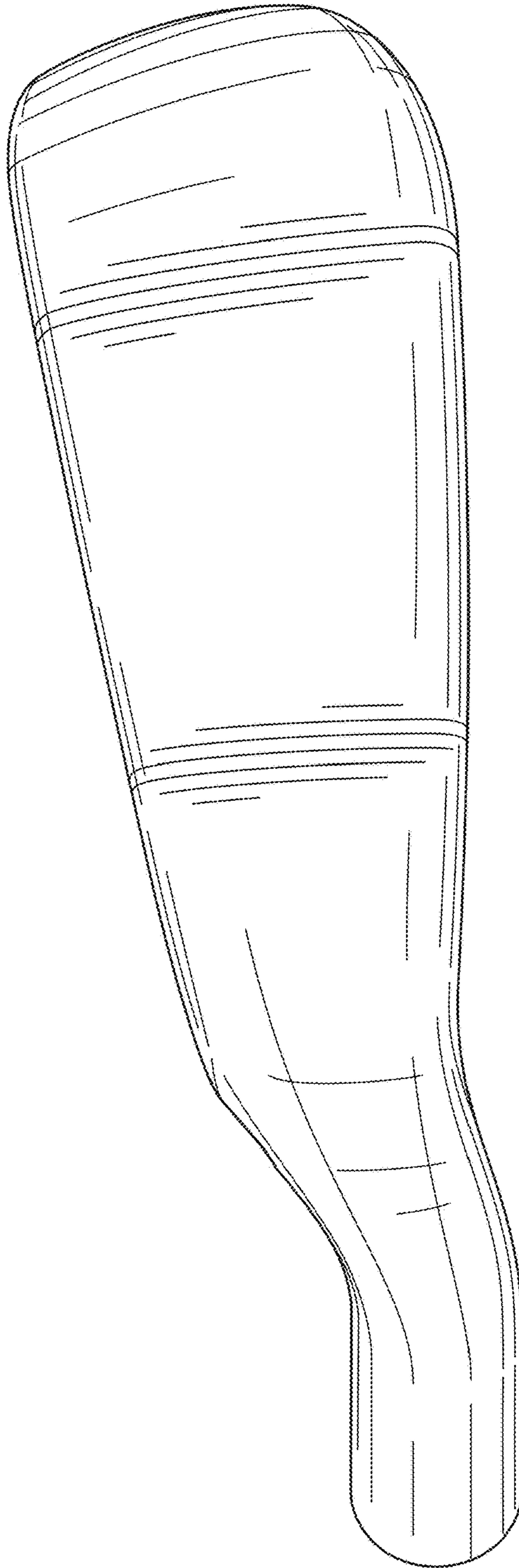

FIG. 6

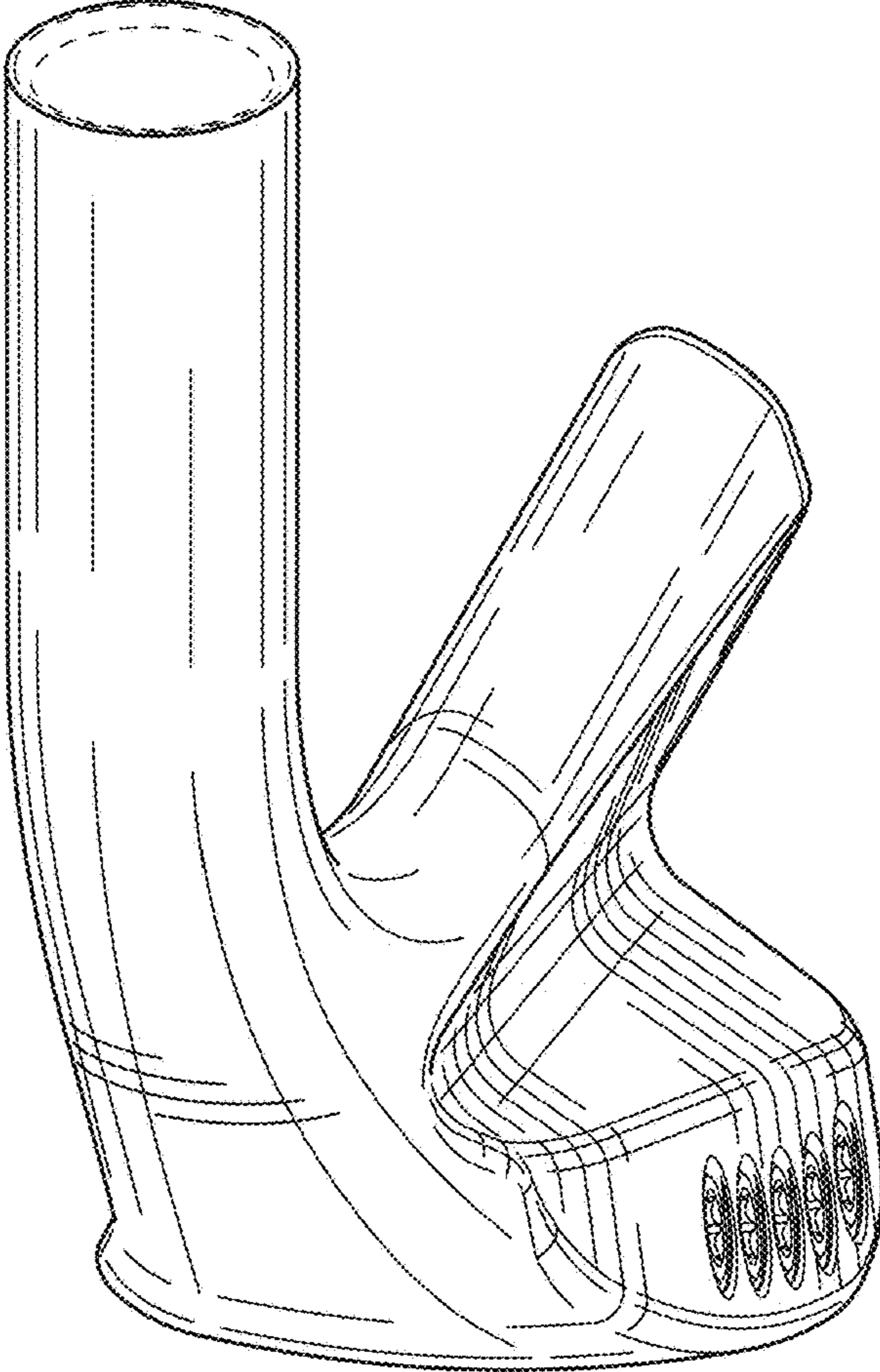

FIG. 7



FIG. 8

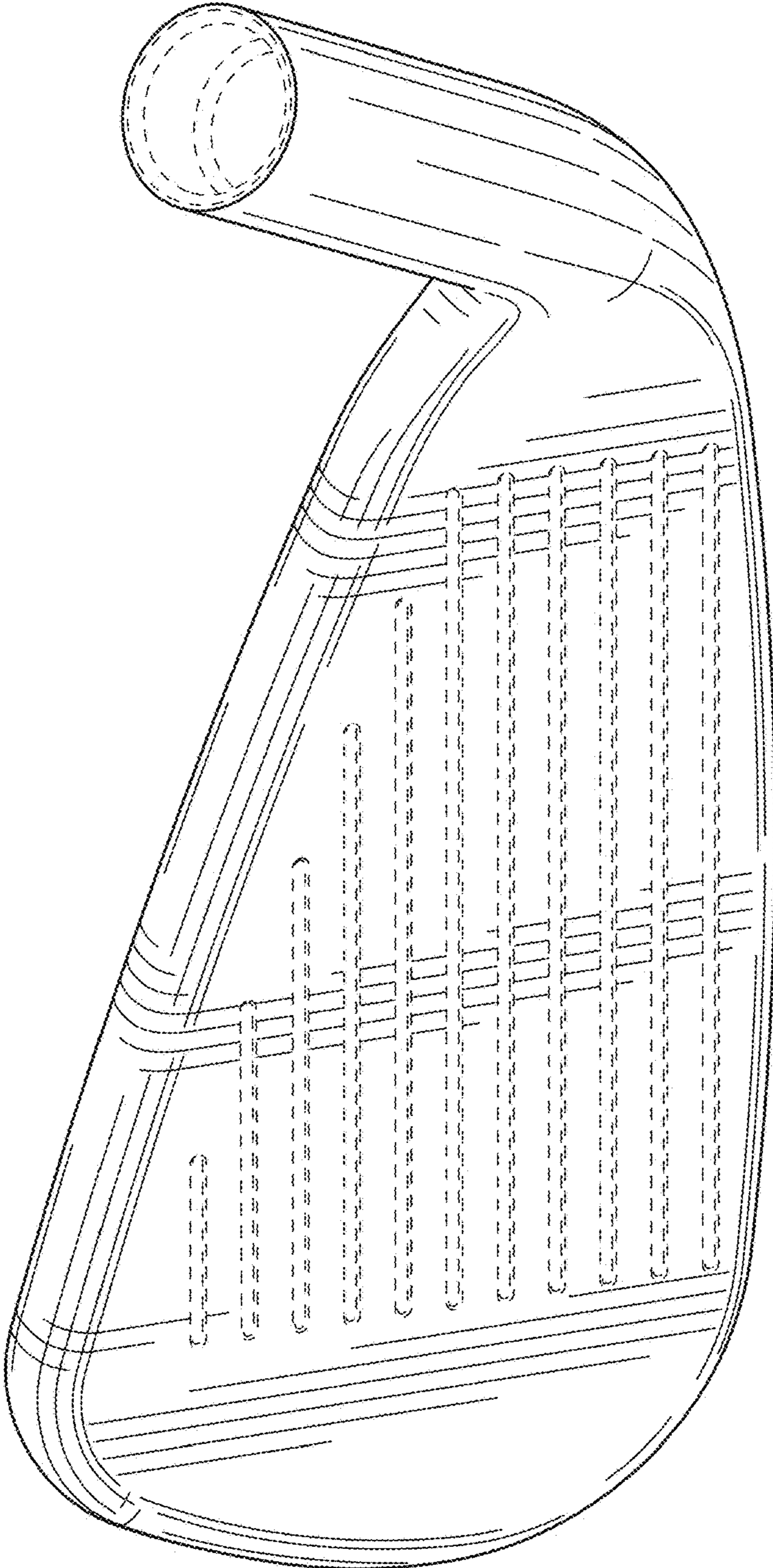

FIG. 9

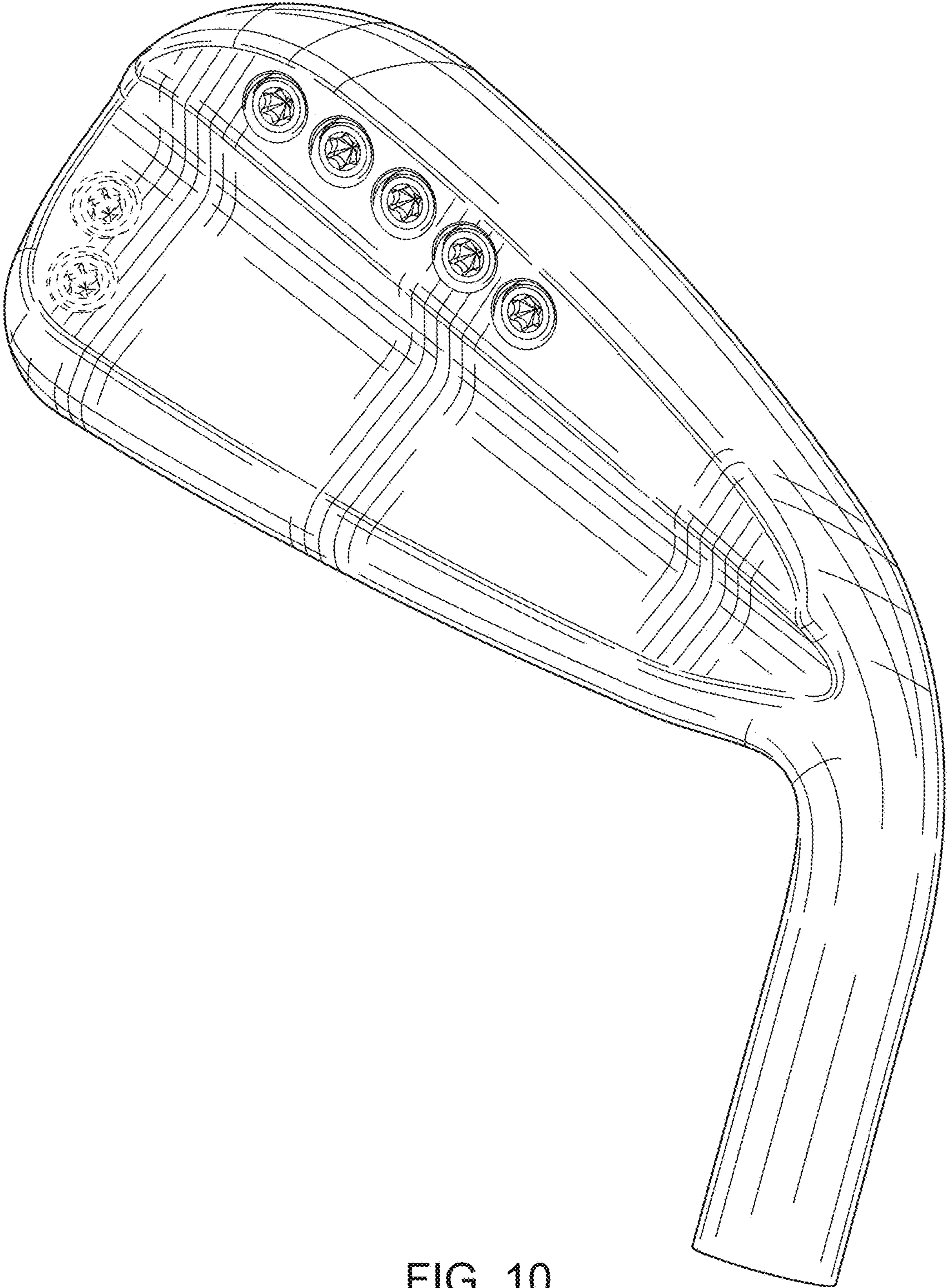

FIG. 10

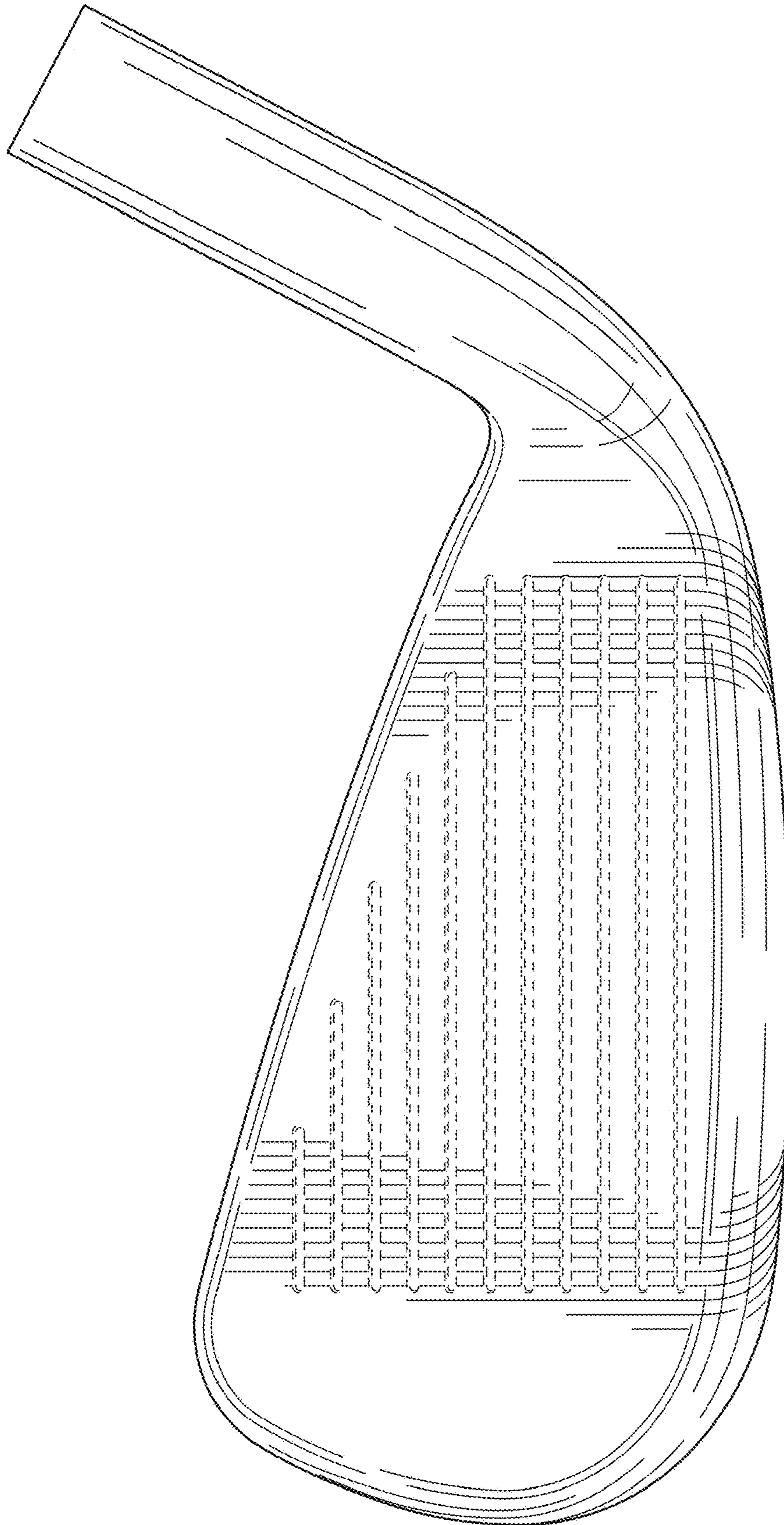

FIG. 11

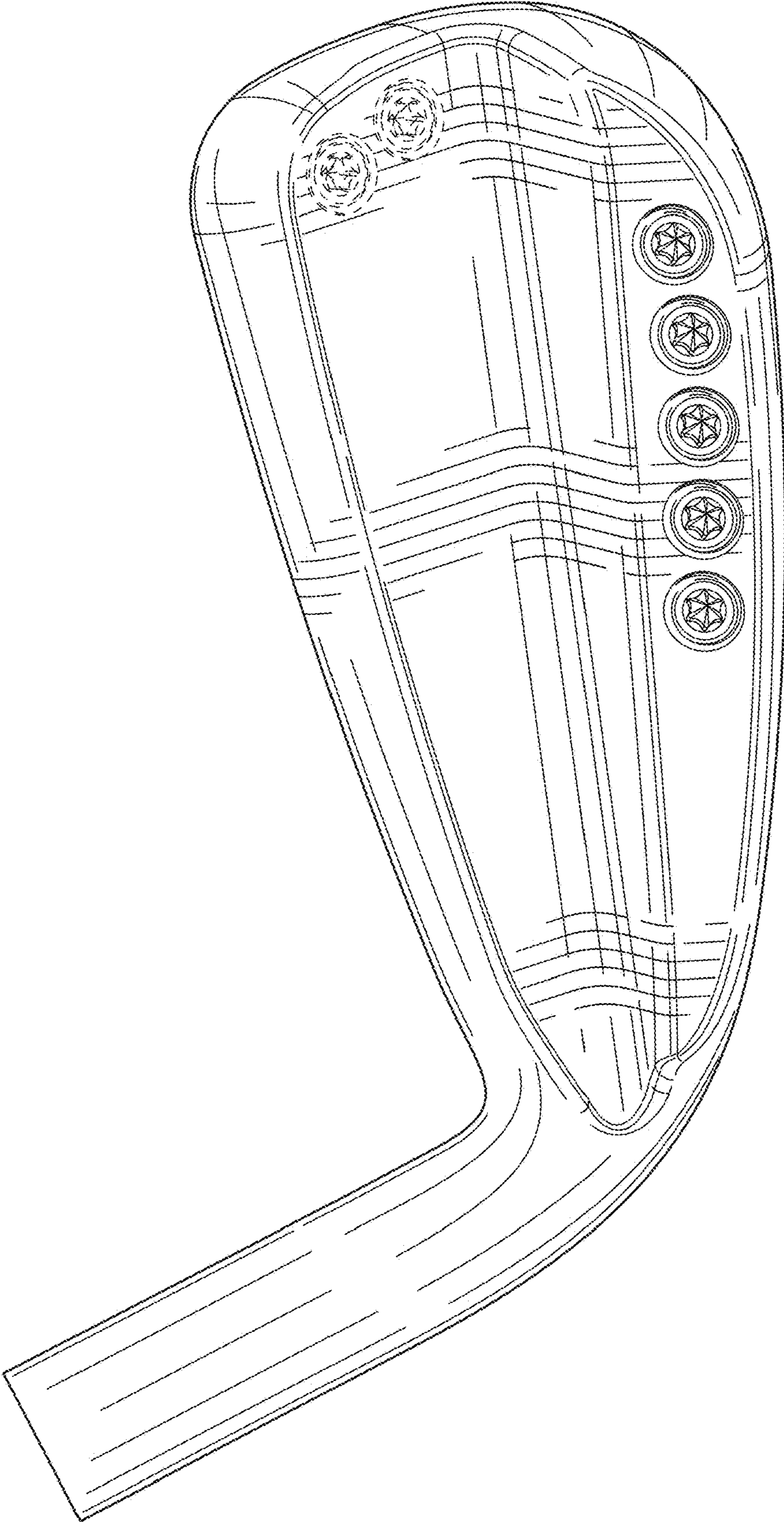

FIG. 12

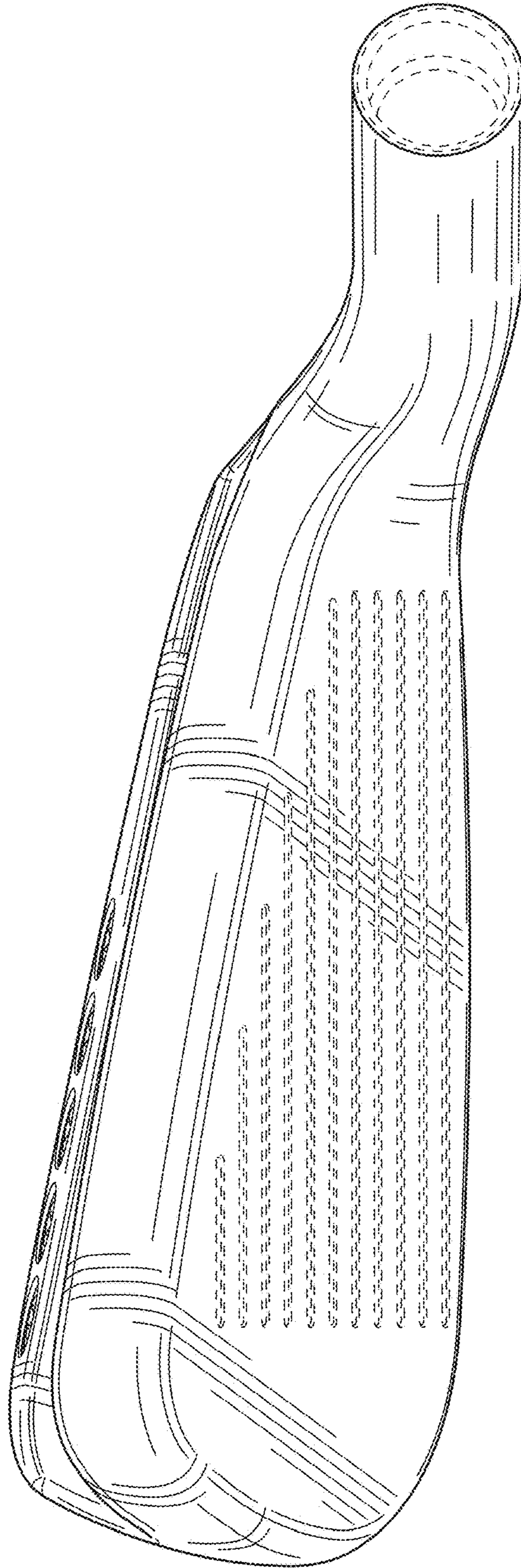

FIG. 13

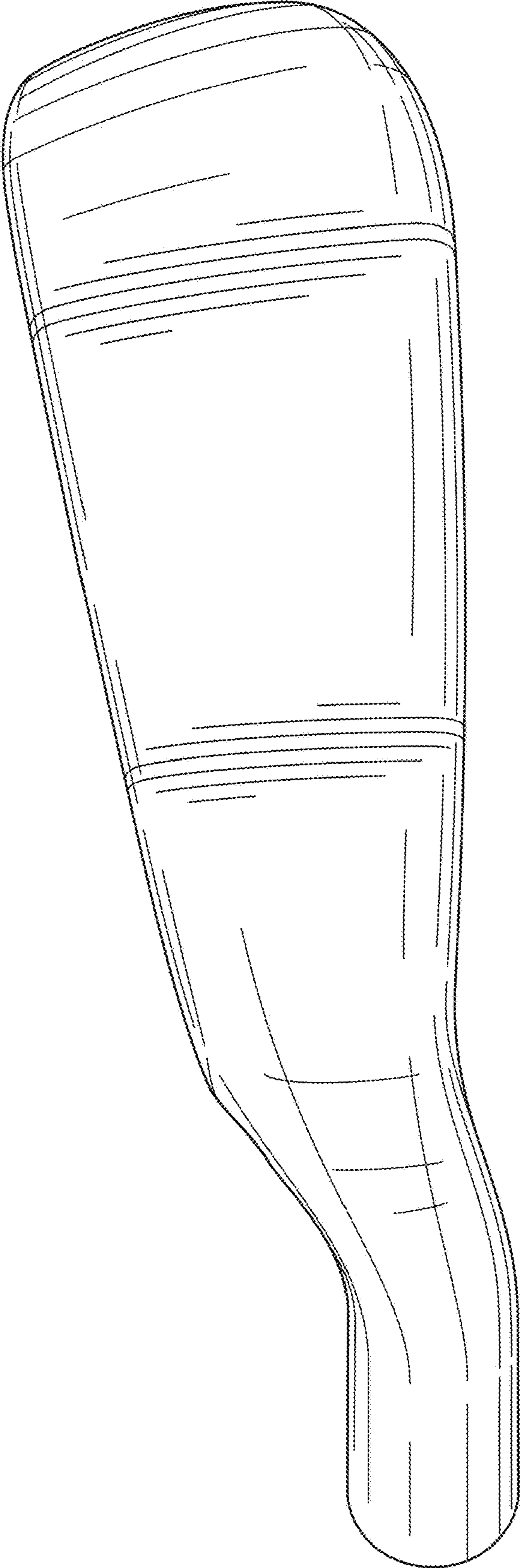

FIG. 14

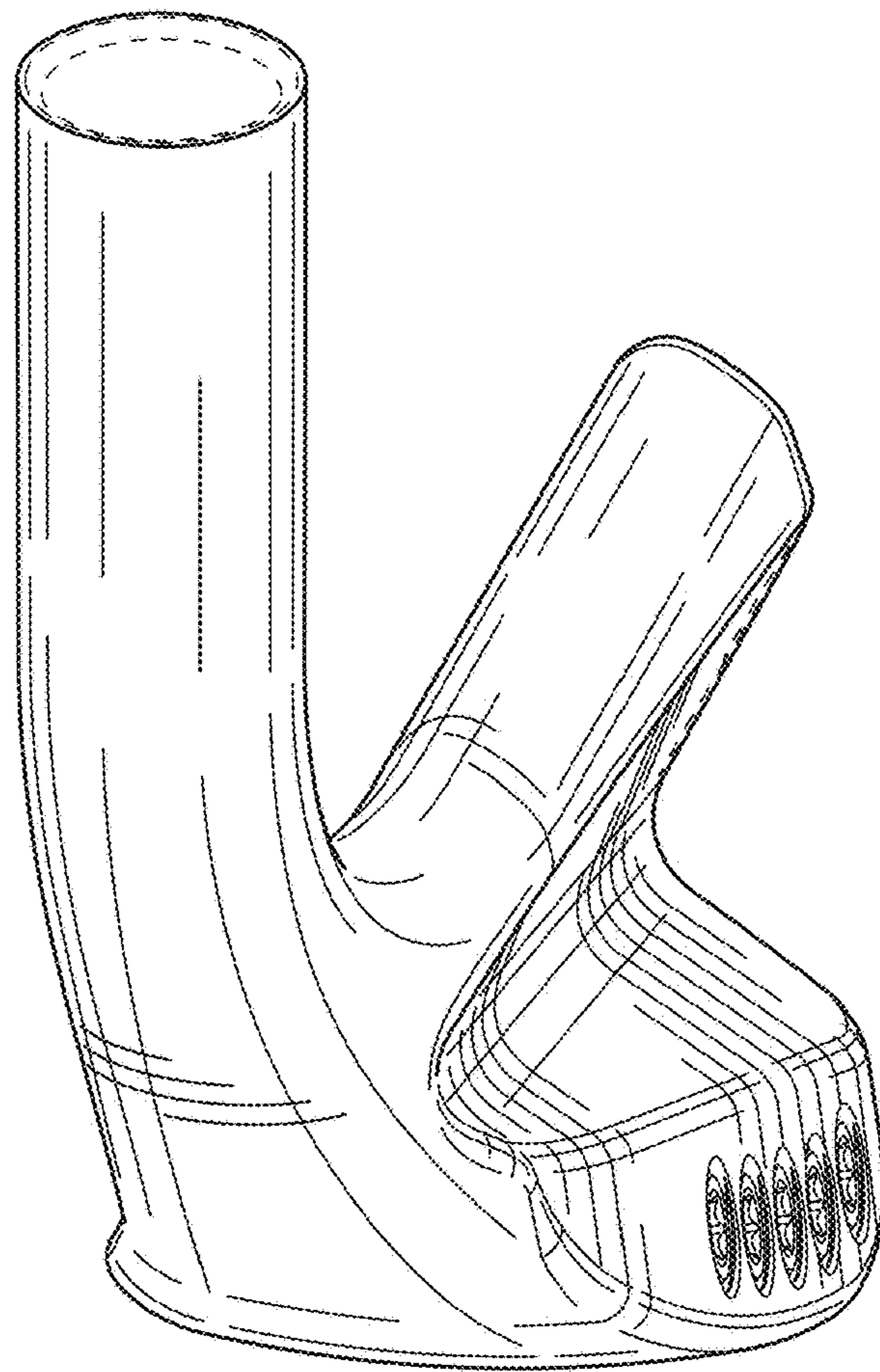

FIG. 15



FIG. 16

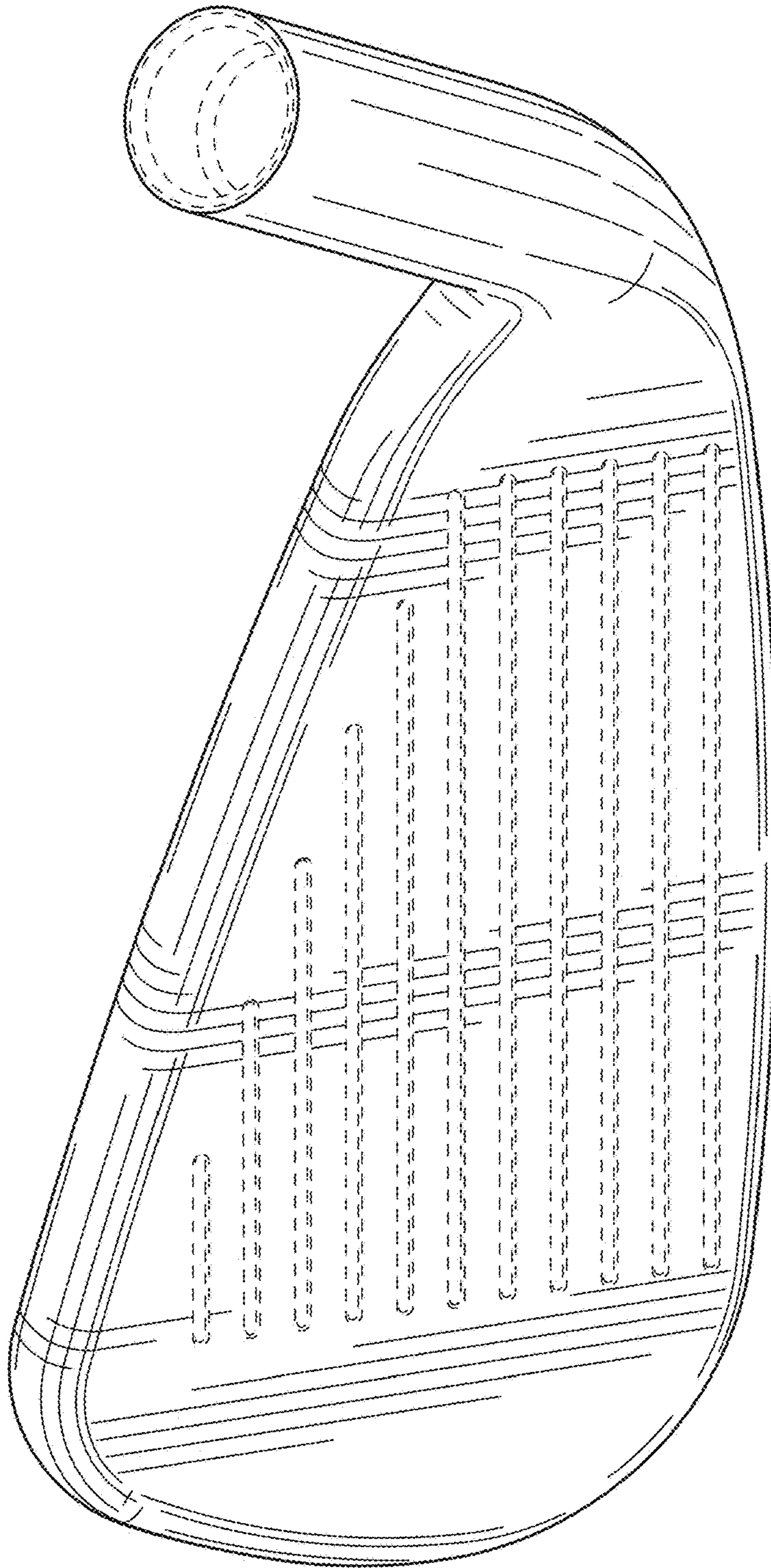

FIG. 17

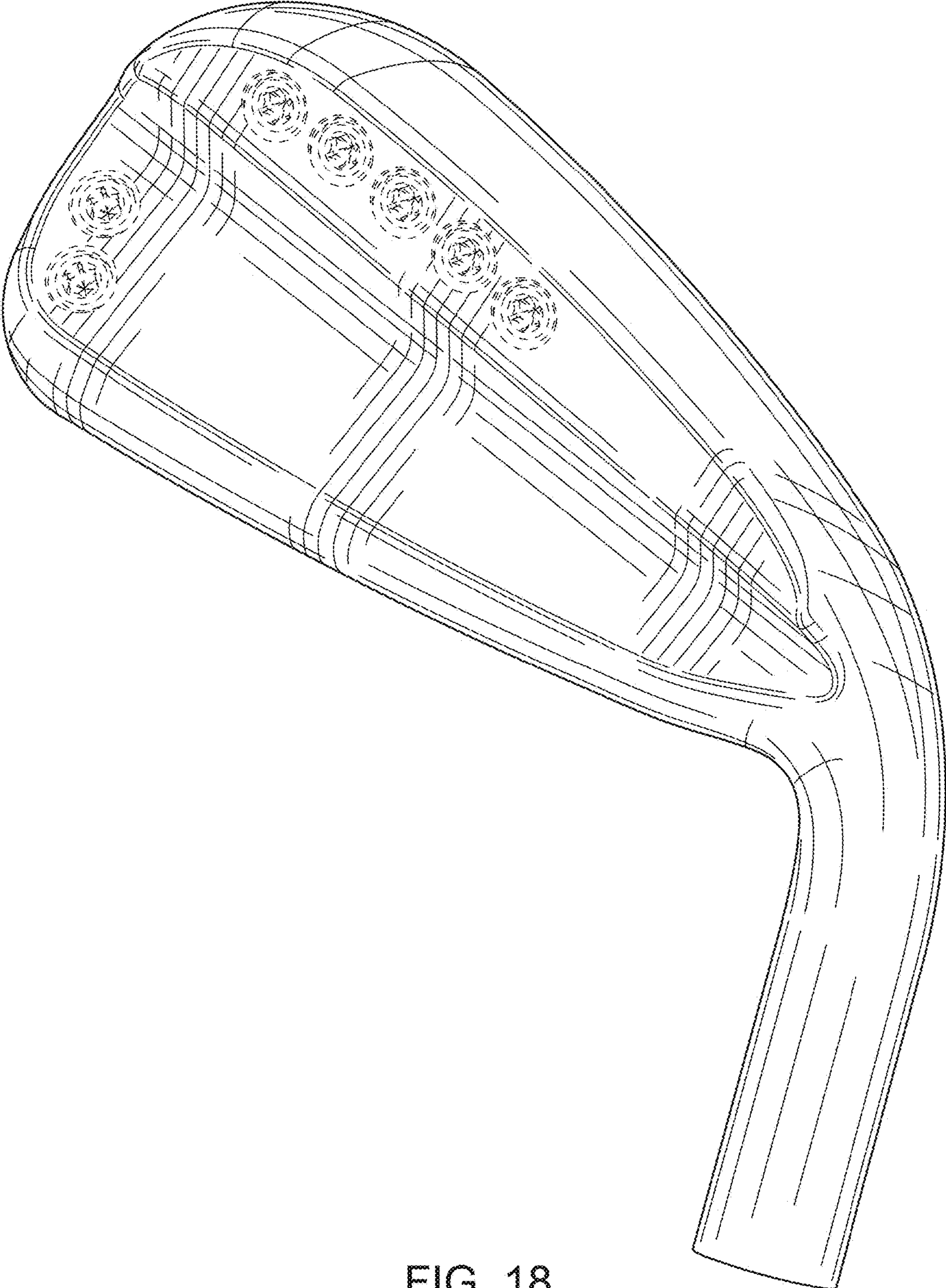

FIG. 18

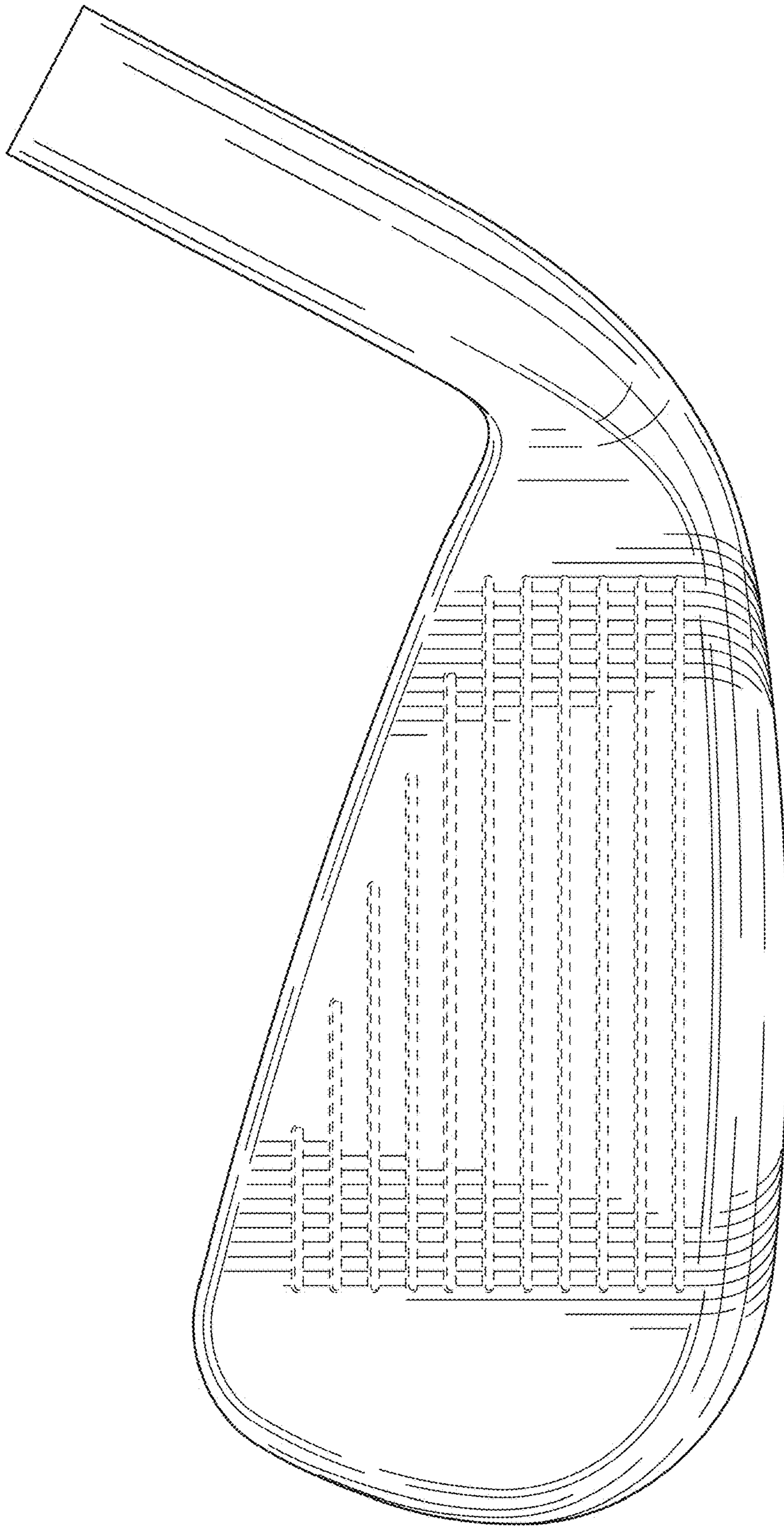

FIG. 19

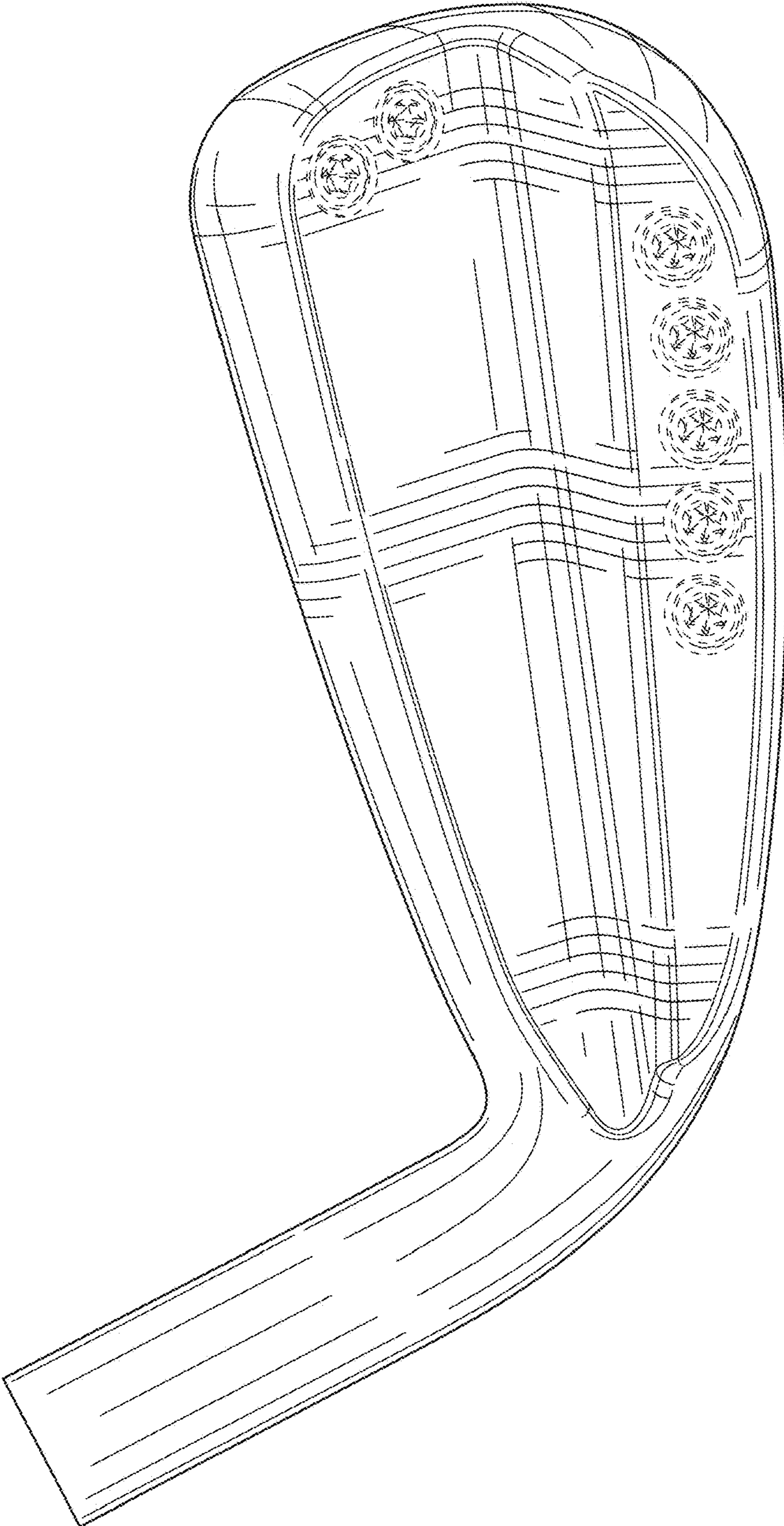

FIG. 20

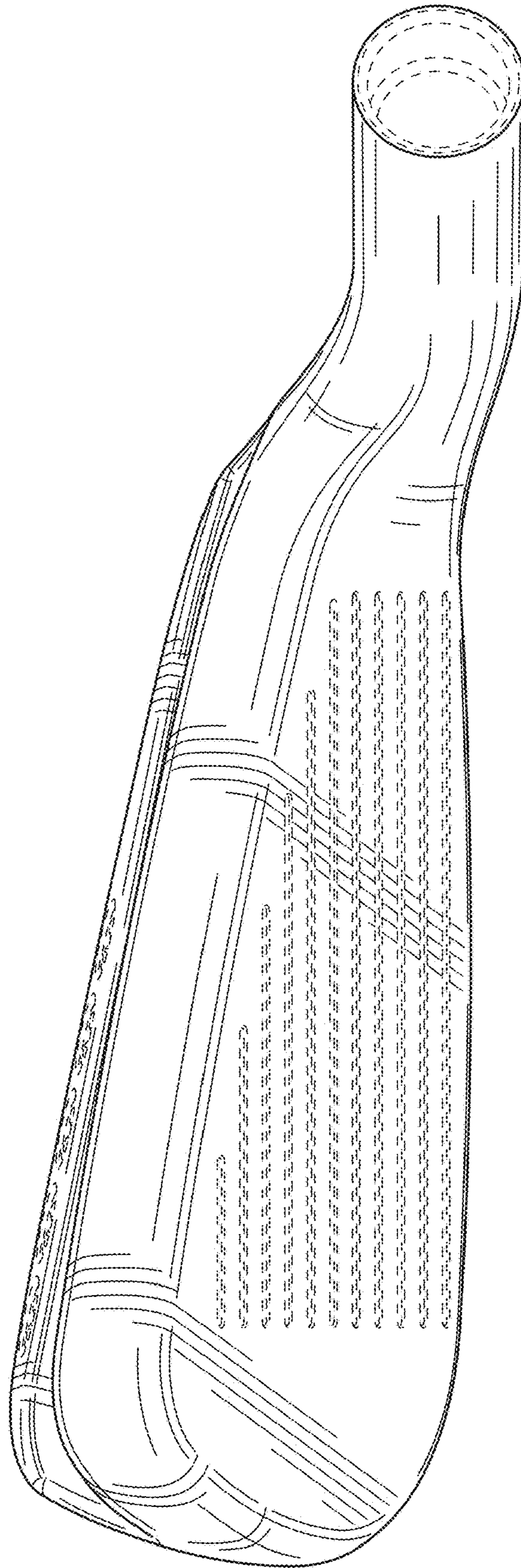

FIG. 21

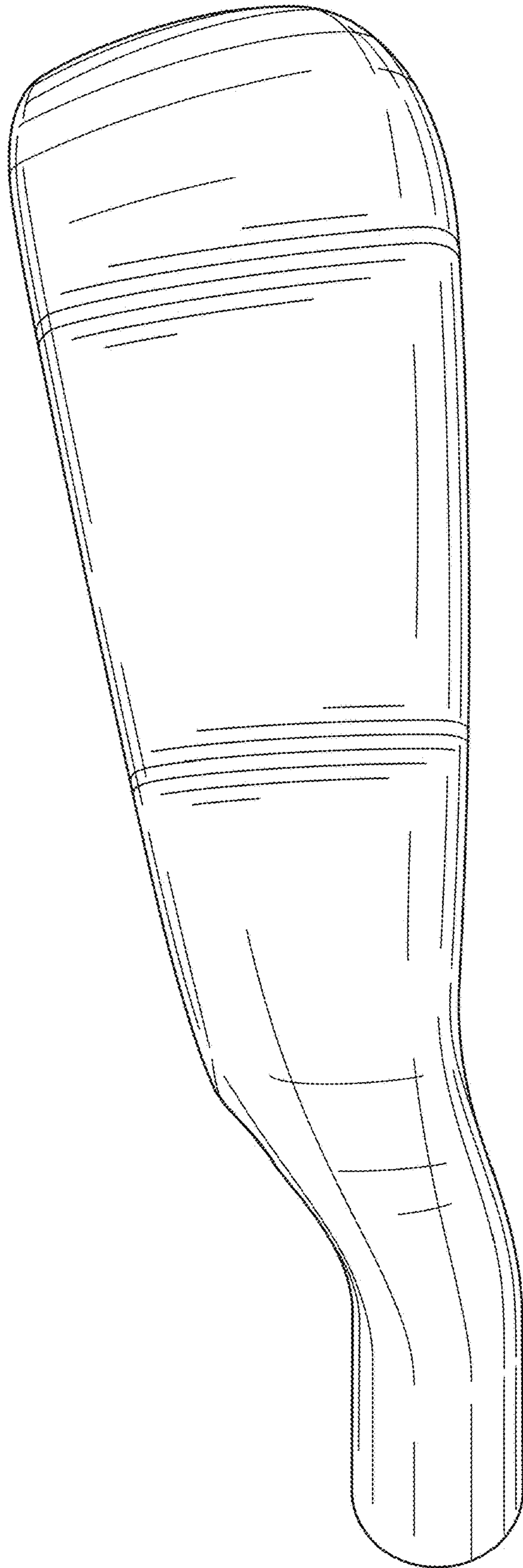

FIG. 22

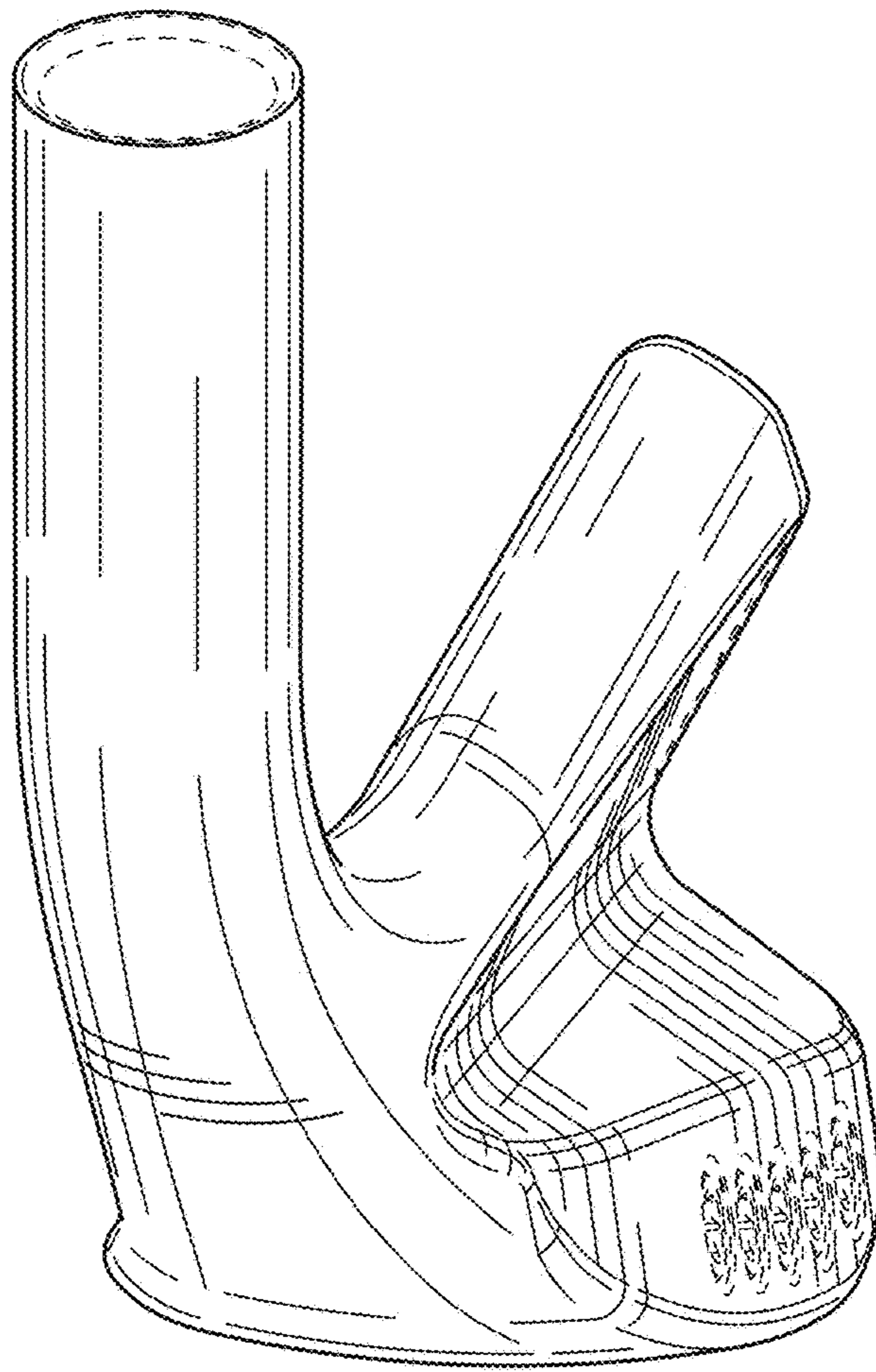

FIG. 23



FIG. 24