



US00D856196S

(12) **United States Design Patent** (10) **Patent No.:** **US D856,196 S**
Guenther (45) **Date of Patent:** **** Aug. 13, 2019**

- (54) **BELLY DUMP HD TRAILER**
- (71) Applicant: **Ampla Group, Inc.**, Elmendorf, TX (US)
- (72) Inventor: **Jacob Froese Guenther**, Cusihuiriachi (MX)
- (73) Assignee: **Ampla Group, Inc.**, Elmendorf, TX (US)

(**) Term: **15 Years**
 (21) Appl. No.: **29/576,954**

- (22) Filed: **Sep. 8, 2016**
- (51) **LOC (12) Cl.** **12-08**
- (52) **U.S. Cl.**
USPC **D12/95**
- (58) **Field of Classification Search**
USPC D12/93, 94, 95, 96, 97, 98, 99, 100, 400,
D12/406, 412, 413, 414, 414.1, 101, 102,
D12/103, 104, 105, 106
CPC .. B60P 1/56; B60P 3/222; B60P 3/224; B61D
7/04; B61D 7/07; B23K 31/02
See application file for complete search history.

(56) **References Cited**

U.S. PATENT DOCUMENTS

- 3,298,745 A * 1/1967 Czapiewski B60P 1/56
105/240
- 3,310,345 A * 3/1967 Rowden B60P 1/60
105/250
- D220,174 S * 3/1971 Holland D12/97
- 3,896,947 A * 7/1975 Pearce B60P 1/006
222/517
- 4,348,047 A * 9/1982 Harshman B60P 1/56
105/247
- D337,080 S * 7/1993 Schlake D12/95
- 6,164,866 A * 12/2000 Wulff B60P 1/56
404/104

- D783,458 S * 4/2017 Pistacchio D12/101
- D786,942 S * 5/2017 Blitterswijk D15/27
- 2009/0085394 A1* 4/2009 Lemmons B60P 1/56
298/27
- 2012/0212032 A1* 8/2012 Hauth B60P 1/56
298/38
- 2012/0285346 A1* 11/2012 Forbes B61D 7/28
105/248
- 2014/0001818 A1* 1/2014 Van Mill B60P 1/56
298/27

OTHER PUBLICATIONS

Durahaul.com. "HD Belly Dump." Retrieved May 19, 2017. (<http://www.durahaul.com/products/205tandemhdbellydump>).*

* cited by examiner

Primary Examiner — Susan E Krakower
Assistant Examiner — Jerry Shiuan-Hua Hsu
 (74) *Attorney, Agent, or Firm* — Miguel Villarreal, Jr.;
 Gunn, Lee & Cave, P.C.

(57) **CLAIM**

An ornamental design for a belly dump HD trailer, as shown and described.

DESCRIPTION

FIG. 1 is a top view of a belly dump HD trailer showing my new design.
 FIG. 2 is a right-side elevation of FIG. 1.
 FIG. 3 is a left-side elevation view of FIG. 1.
 FIG. 4 is a front view of FIG. 1.
 FIG. 5 is a back view of FIG. 1.
 FIG. 6 is a bottom view of FIG. 1; and,
 FIG. 7 is a front, right perspective view of FIG. 1.
 The broken lines illustrate portions of the belly dump HD trailer that form no part of the claimed design.

1 Claim, 7 Drawing Sheets

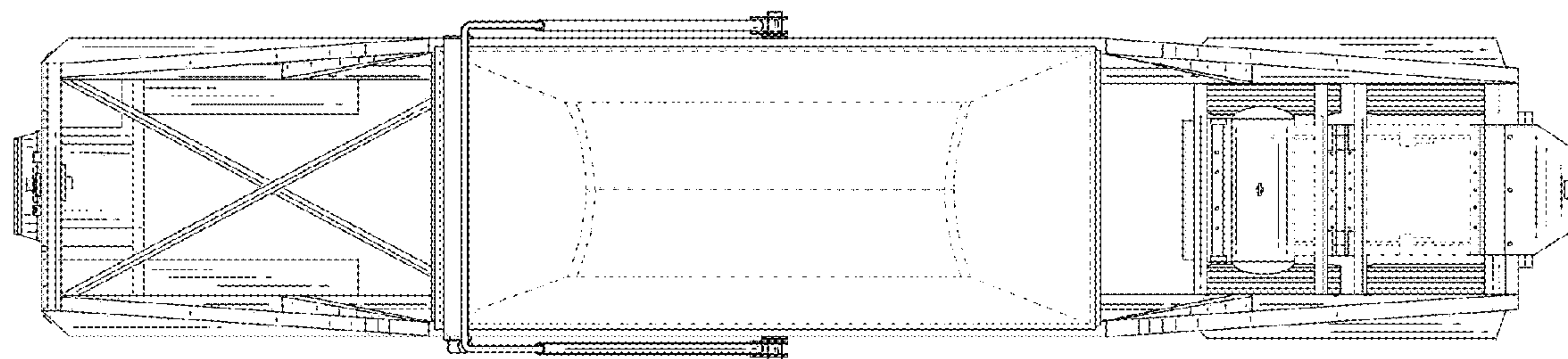

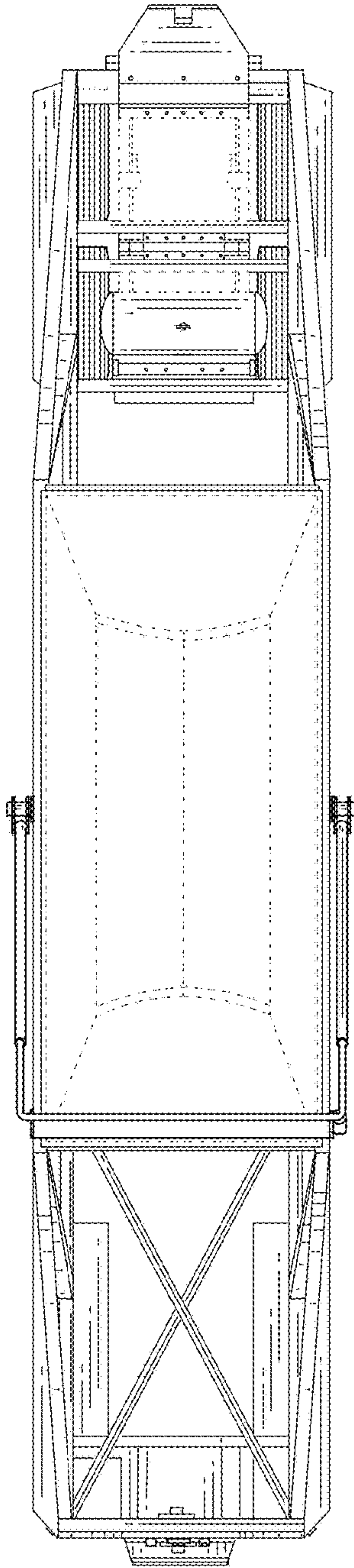

Fig. 1

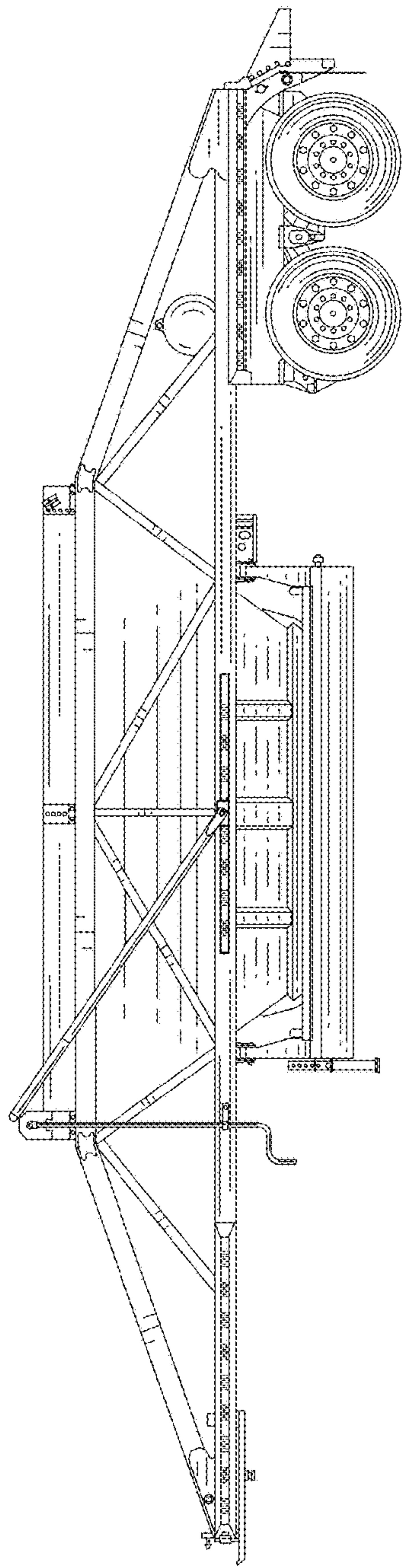

Fig. 2

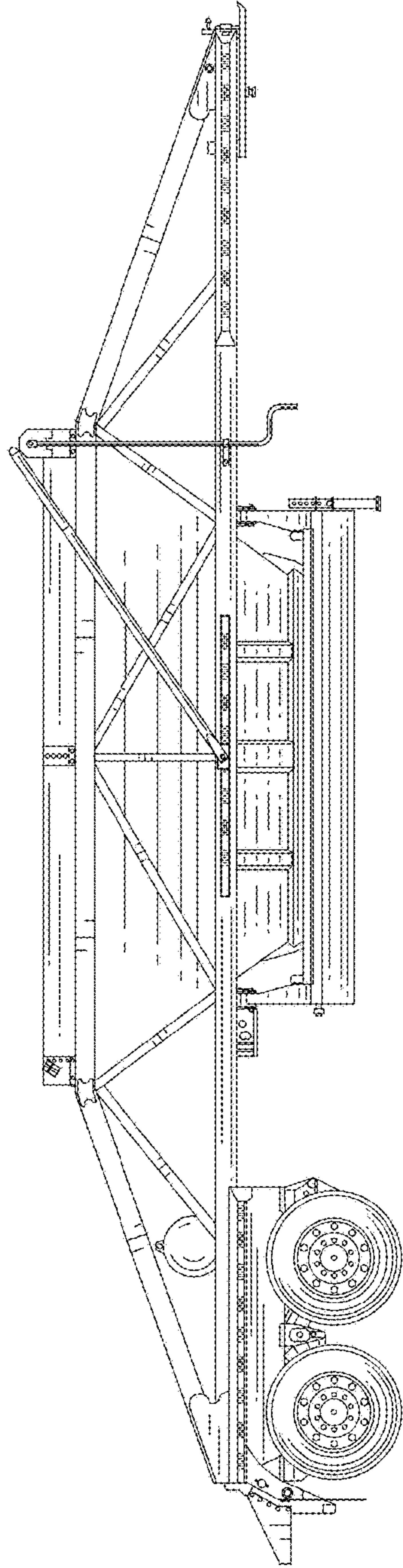

Fig. 3

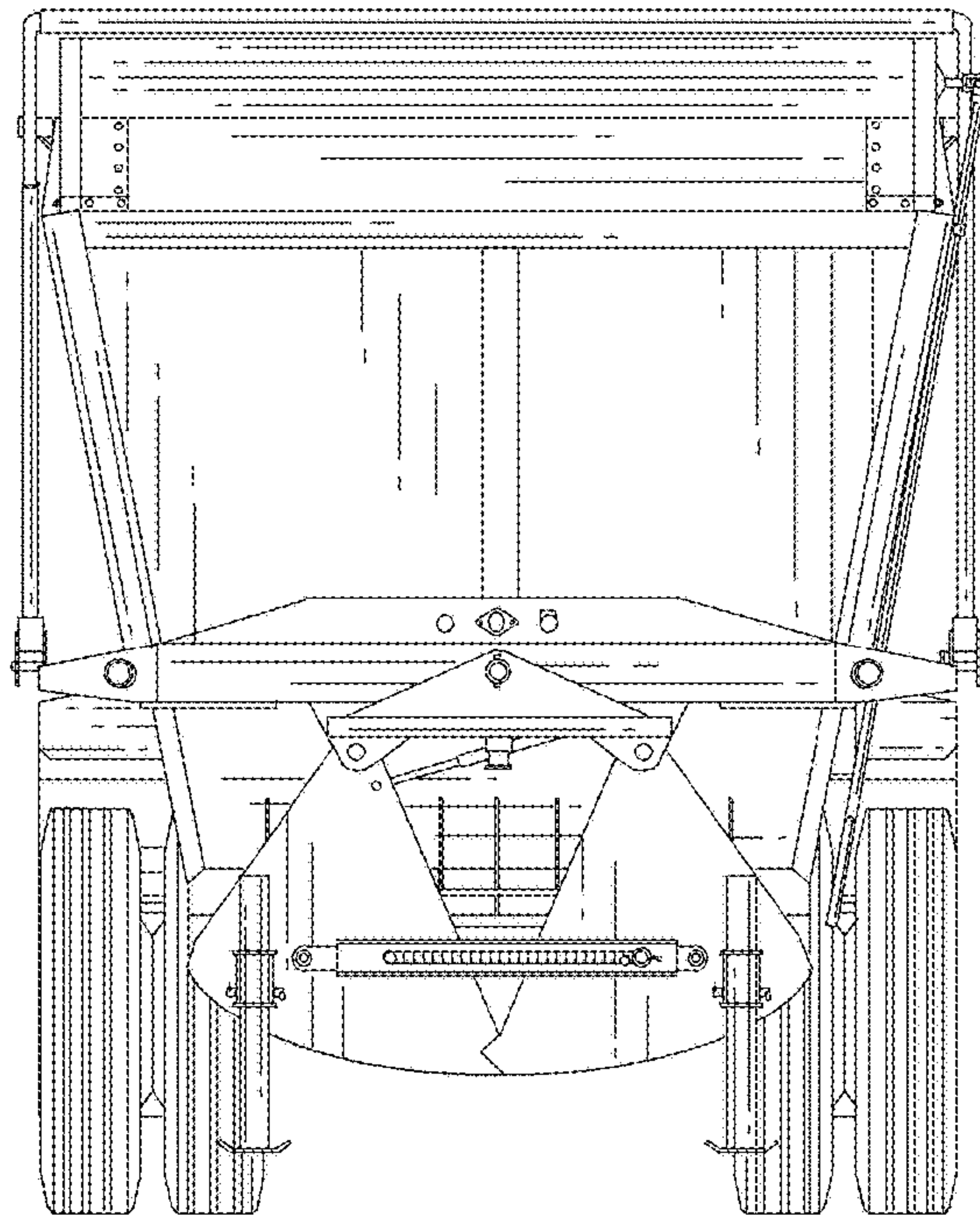

Fig. 4

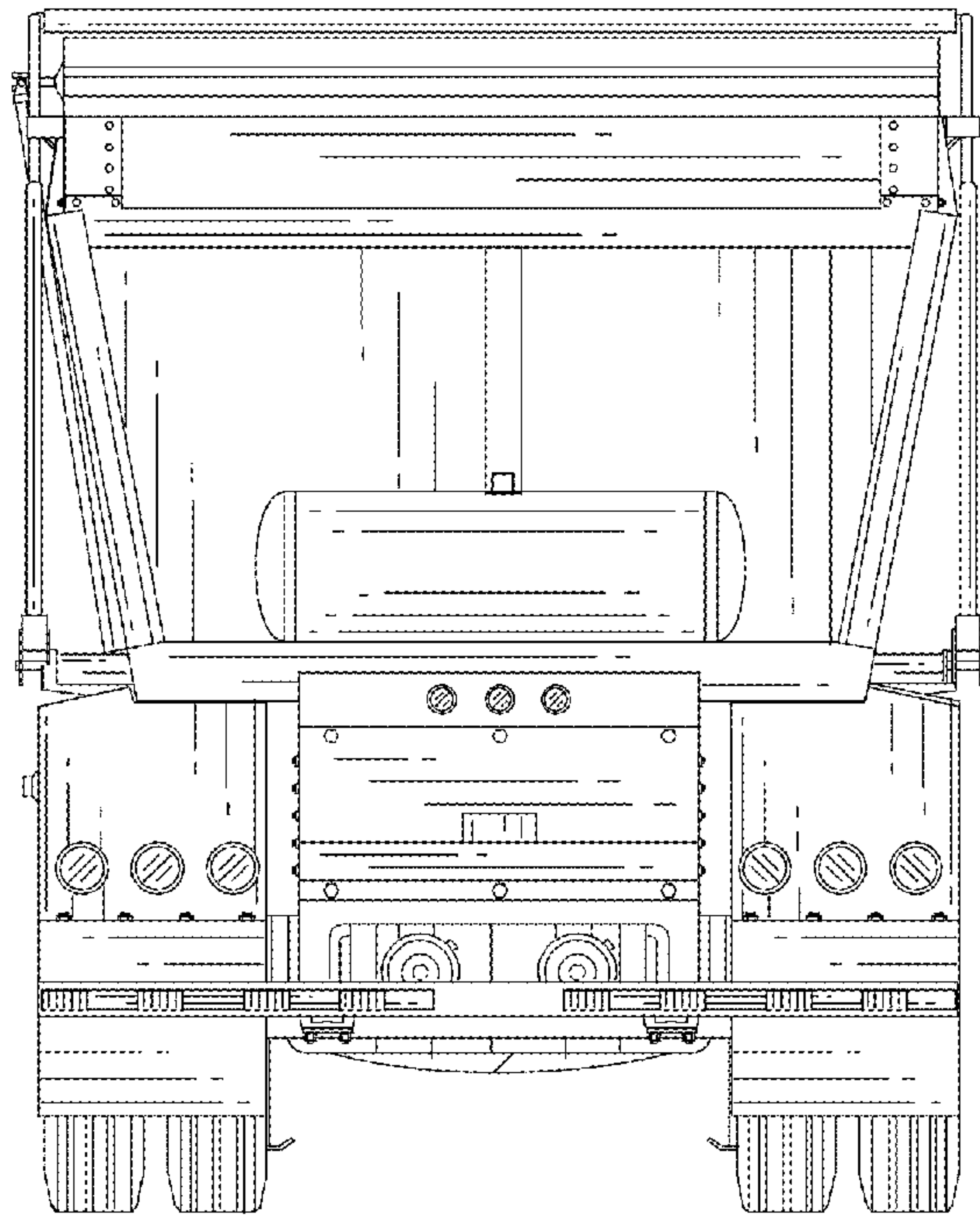

Fig. 5

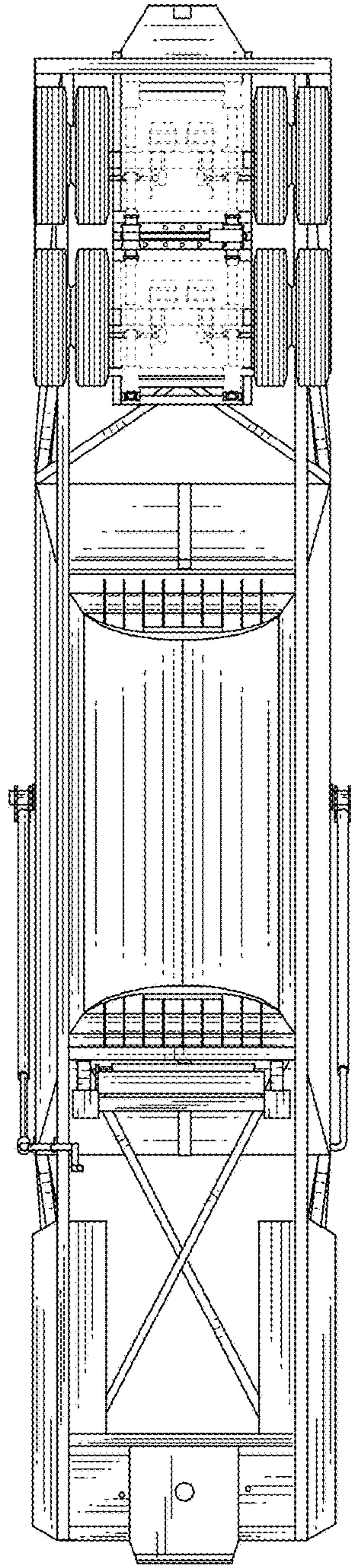

Fig. 6

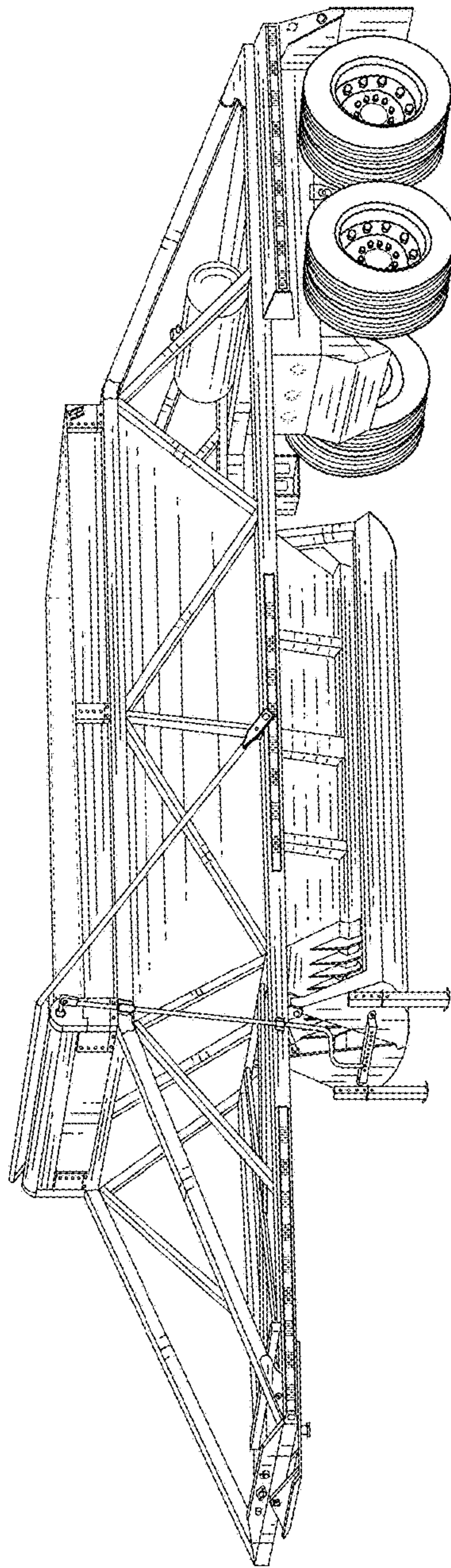

Fig. 7