



US00D856188S

(12) **United States Design Patent**
Caple

(10) **Patent No.:** **US D856,188 S**

(45) **Date of Patent:** **** Aug. 13, 2019**

- (54) **FLAGPOLE HOLDER**
- (71) Applicant: **Lewis C Caple**, Newfield, NJ (US)
- (72) Inventor: **Lewis C Caple**, Newfield, NJ (US)
- (**) Term: **15 Years**
- (21) Appl. No.: **29/623,090**
- (22) Filed: **Oct. 23, 2017**
- (51) **LOC (12) Cl.** **11-05**
- (52) **U.S. Cl.**
USPC **D11/182**
- (58) **Field of Classification Search**
USPC D11/182; D8/349, 350; 248/85, 88, 430,
248/530
CPC E04H 12/32; G09F 17/00
See application file for complete search history.

- 7,938,565 B2 * 5/2011 Richard F21S 8/081
362/153.1
- D662,442 S * 6/2012 Ettorre D11/182
- 2009/0175046 A1 * 7/2009 Richard F21S 8/081
362/431
- 2015/0241107 A1 * 8/2015 Mech F25D 3/08
220/592.01

* cited by examiner

Primary Examiner — Michael A. Pratt

(74) *Attorney, Agent, or Firm* — Stuart M. Goldstein

(57) **CLAIM**

The ornamental design for a flagpole holder, as shown and described.

DESCRIPTION

FIG. 1 is a top perspective view of the flagpole holder of the present invention.
 FIG. 2 is a bottom perspective view of the flagpole holder of the present invention.
 FIG. 3 is an elevation view of the flagpole holder of the present invention.
 FIG. 4 is another elevation view of the flagpole holder of the present invention.
 FIG. 5 is a top view of the flagpole holder of the present invention.
 FIG. 6 is a bottom view of the flagpole holder of the present invention; and,
 FIG. 7 is a top perspective view of the flagpole holder of the present invention in use condition.
 The broken lines are shown for environmental purposes only and form no part of the claimed design.

1 Claim, 4 Drawing Sheets

(56) **References Cited**

U.S. PATENT DOCUMENTS

- 3,267,901 A * 8/1966 Carroll G01C 15/06
116/209
- 3,816,959 A * 6/1974 Nalle, Jr. A01G 13/0243
47/21.1
- 3,823,942 A * 7/1974 Duncan A63B 65/12
273/338
- 5,217,194 A * 6/1993 Brownell A63G 9/00
135/118
- 5,417,166 A * 5/1995 Credle, Sr. A47B 37/04
100/150
- 5,901,497 A * 5/1999 Bulvin A01G 29/00
47/47
- 6,439,744 B1 * 8/2002 Chanslor F21S 6/001
248/511
- 6,461,018 B1 * 10/2002 Chanslor F21S 6/001
248/530

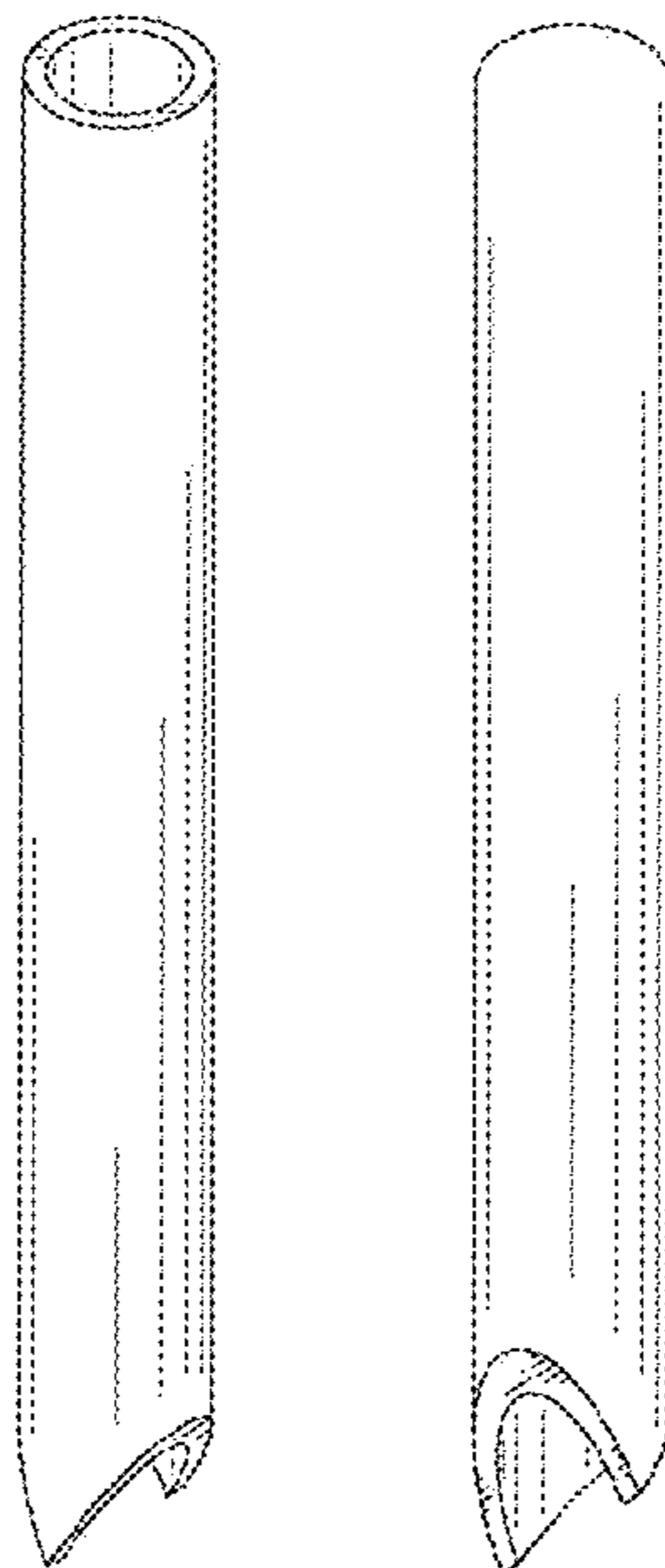

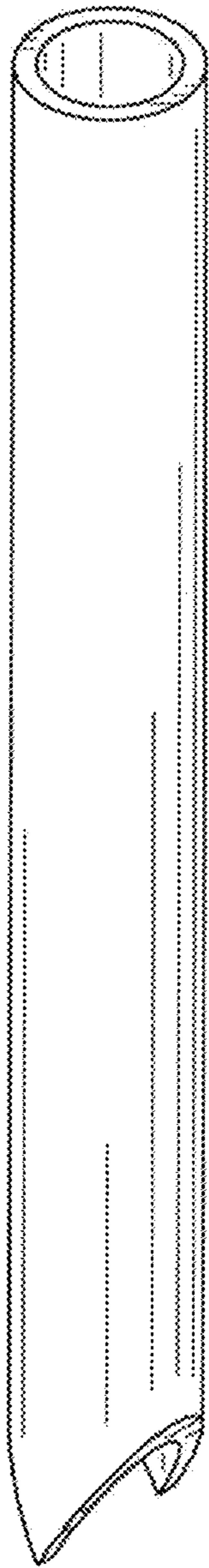

FIG. 1

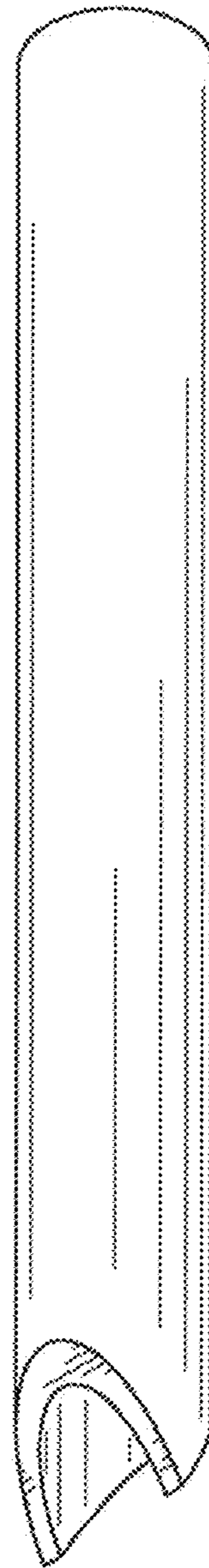

FIG. 2

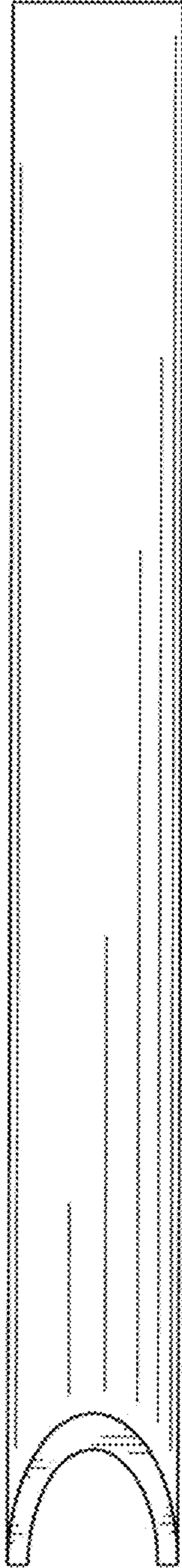

FIG. 3

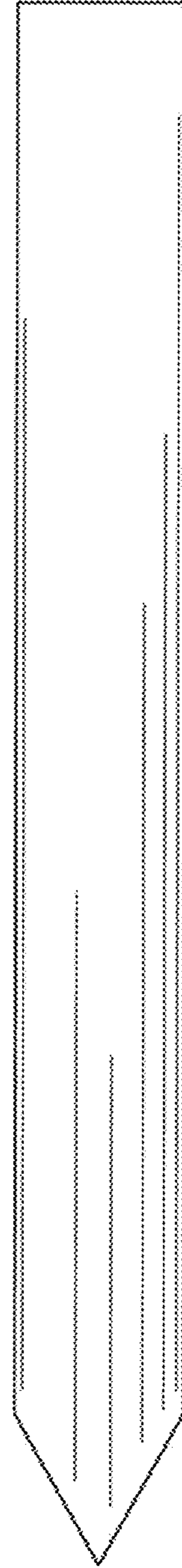

FIG. 4

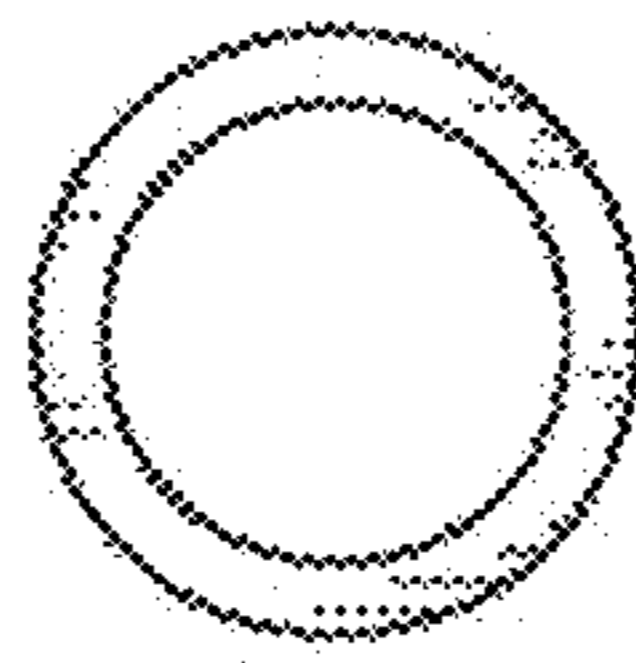

FIG. 5

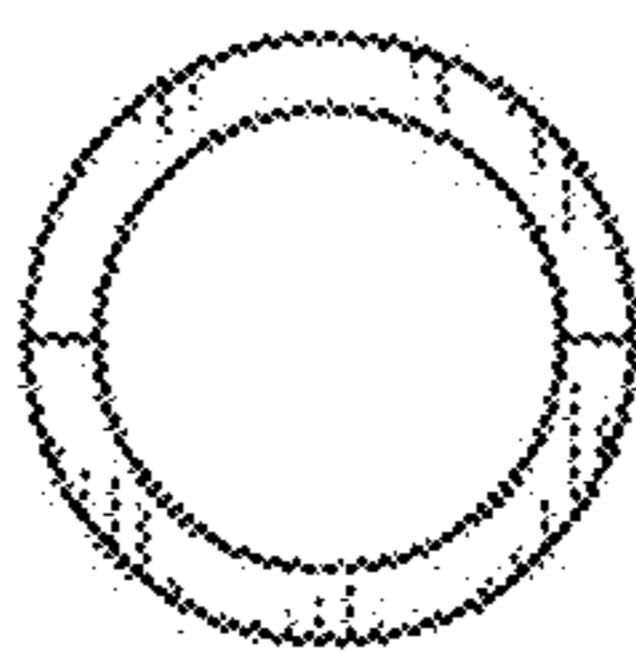

FIG. 6

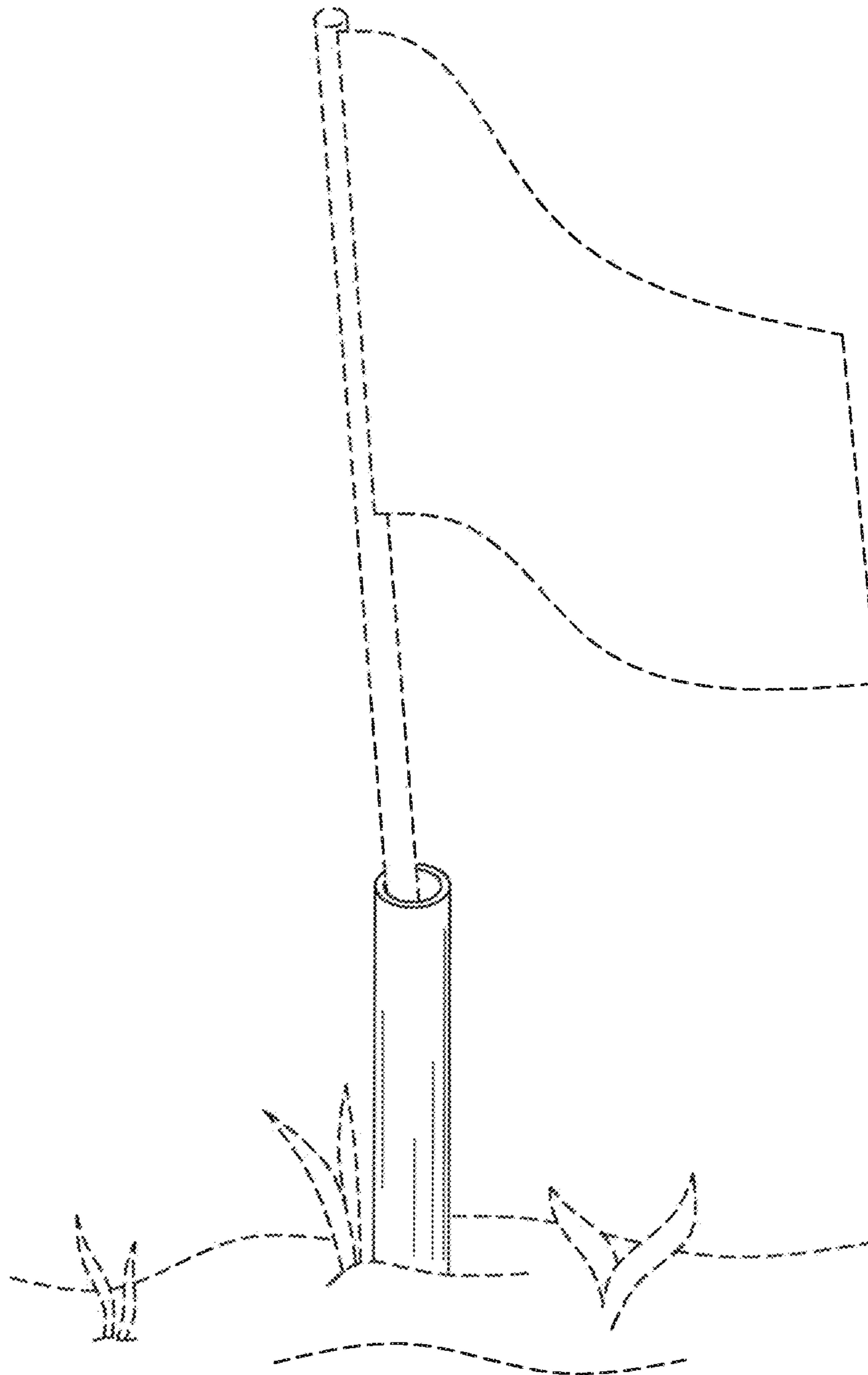

FIG. 7