



US00D856102S

(12) **United States Design Patent**
Jessen

(10) **Patent No.:** **US D856,102 S**

(45) **Date of Patent:** **** Aug. 13, 2019**

- (54) **MOUNTING DEVICE**
- (71) Applicant: **Eberhard Karls Universitaet Tuebingen, Tuebingen (DE)**
- (72) Inventor: **Florian Jessen, Moessingen (DE)**
- (73) Assignee: **Eberhard Karls Universitaet Tuebingen, Tuebingen (DE)**

- 7,857,323 B1 * 12/2010 Berkes B60K 15/04 277/567
- 8,696,411 B1 * 4/2014 Orlando B24B 41/002 451/241
- D754,307 S * 4/2016 Dole D23/262
- D787,026 S * 5/2017 Filer D23/262
- 10,029,348 B2 * 7/2018 Ramirez B24B 55/052
- D835,243 S * 12/2018 Chiproot D23/262
- D836,184 S * 12/2018 Lippka D23/262
- 10,201,889 B2 * 2/2019 Morris B24B 55/052

(**) Term: **15 Years**

(21) Appl. No.: **29/617,246**

(22) Filed: **Sep. 13, 2017**

(30) **Foreign Application Priority Data**

Mar. 17, 2017 (EM) 003805480

(51) **LOC (12) Cl.** **08-05**

(52) **U.S. Cl.**
USPC **D8/70**

(58) **Field of Classification Search**
USPC D23/259, 262-263, 266; D8/70;
D29/130

CPC F16L 37/091; F16L 17/025; F16L 59/021;
B24B 55/052; B24B 23/00; B24B 55/00;
B24B 55/05

See application file for complete search history.

(56) **References Cited**

U.S. PATENT DOCUMENTS

- D383,197 S * 9/1997 Brown D23/266
- D456,685 S * 5/2002 Keller D8/70
- 6,988,939 B2 * 1/2006 Hofmann B23Q 1/017 359/451

FOREIGN PATENT DOCUMENTS

- DE 10 2014 218 922 A1 3/2016
- WO WO 2016/041699 A1 3/2016

* cited by examiner

Primary Examiner — Michael A. Pratt

(74) *Attorney, Agent, or Firm* — Crowell & Moring LLP

(57) **CLAIM**

The ornamental design for a mounting device, as shown and described.

DESCRIPTION

FIG. 1 is a top perspective view of a mounting device according to the design;
 FIG. 2 is a bottom perspective view thereof;
 FIG. 3 is a top view thereof;
 FIG. 4 is a bottom view thereof;
 FIG. 5 is a front view thereof;
 FIG. 6 is a right side view thereof;
 FIG. 7 is a rear view thereof; and,
 FIG. 8 left side view thereof.

1 Claim, 8 Drawing Sheets

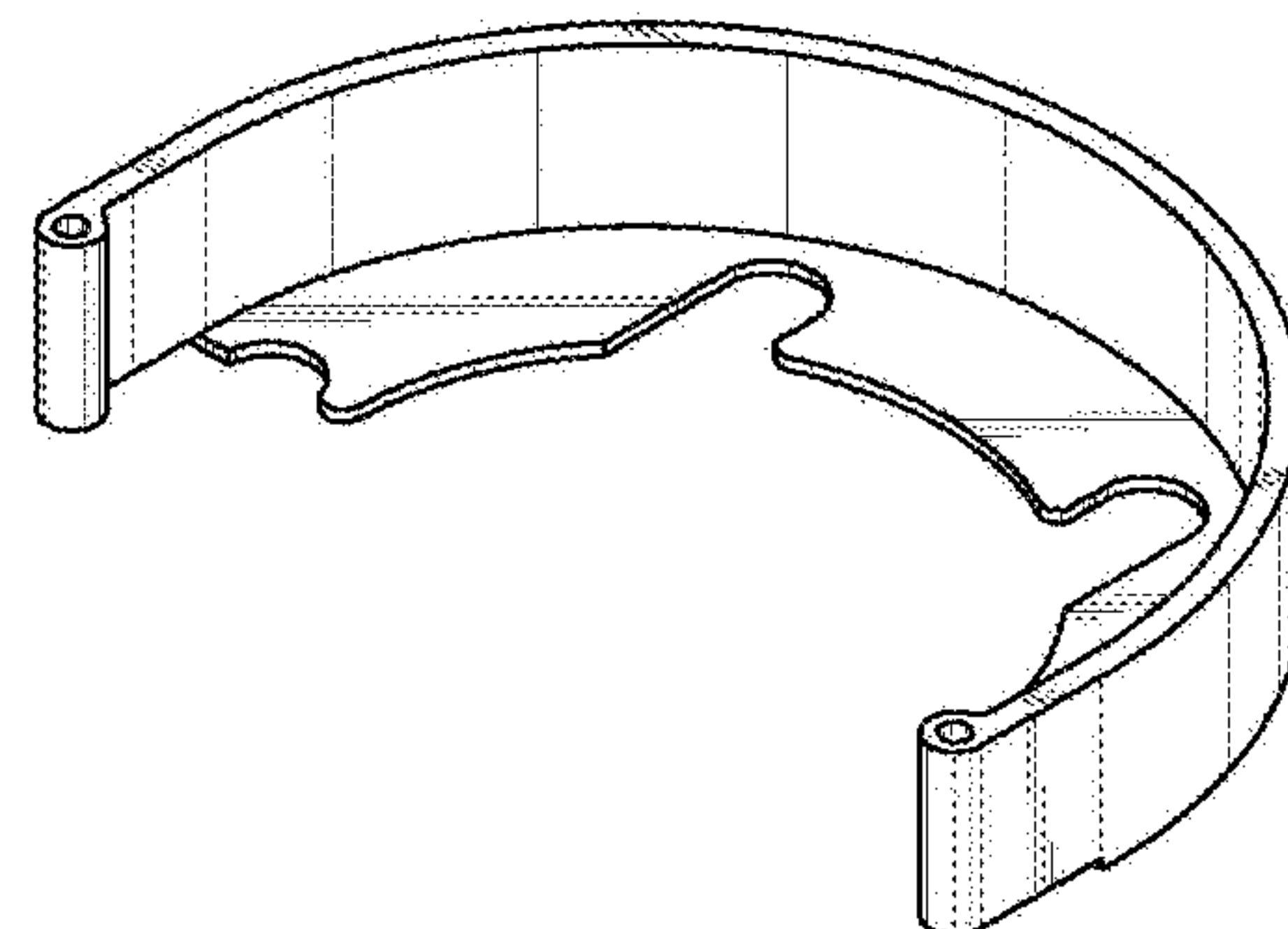
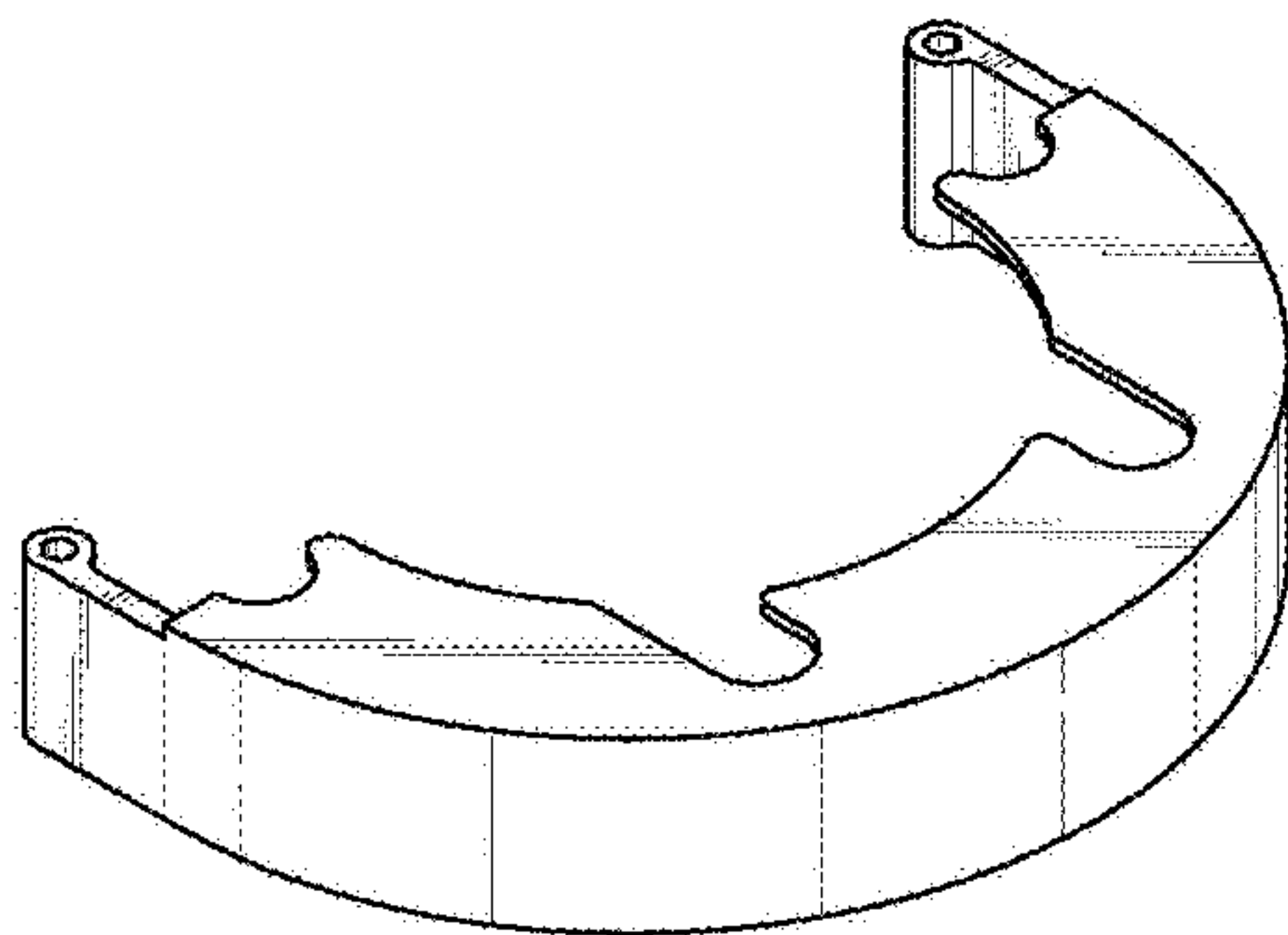

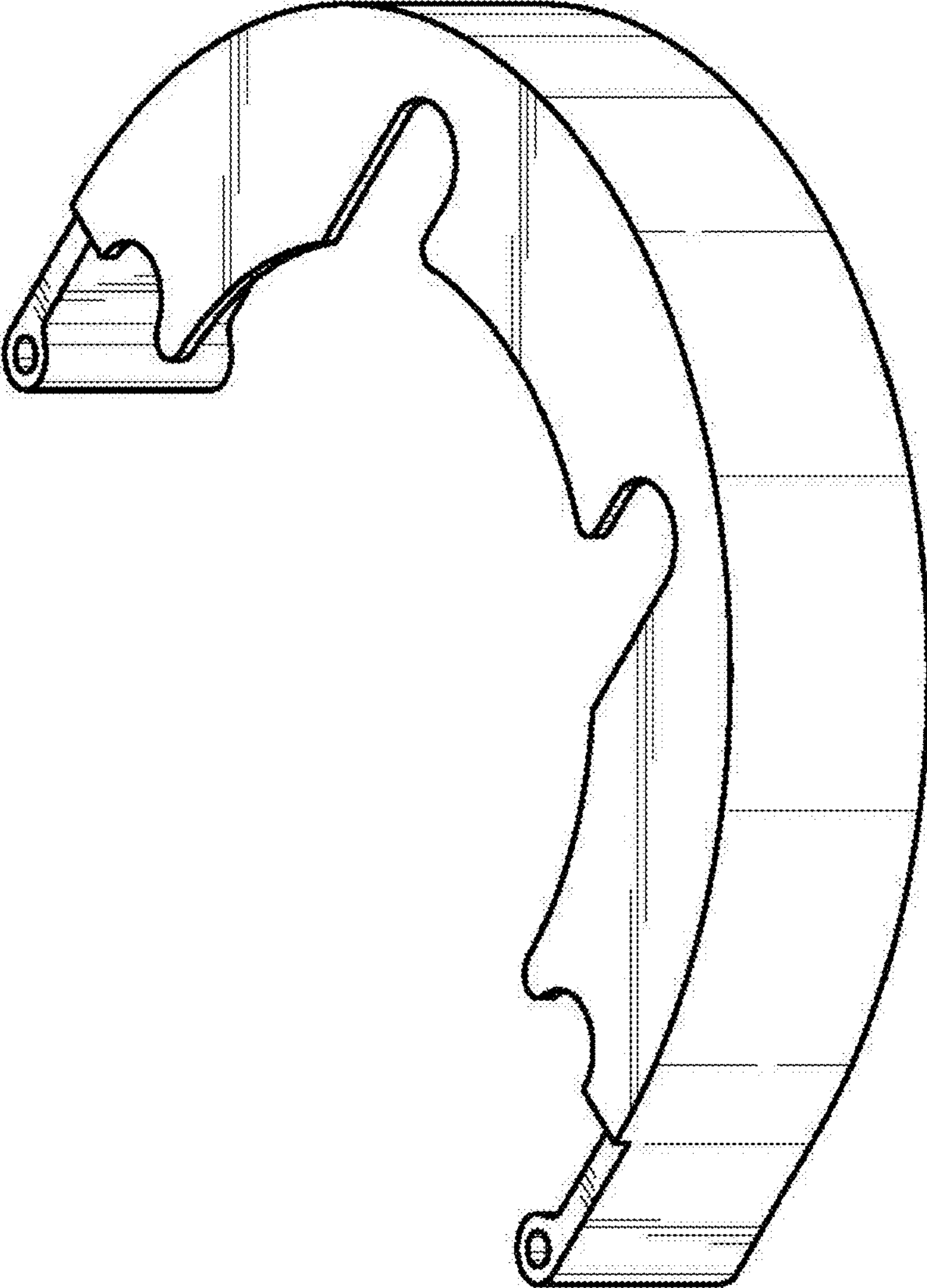

Fig. 1

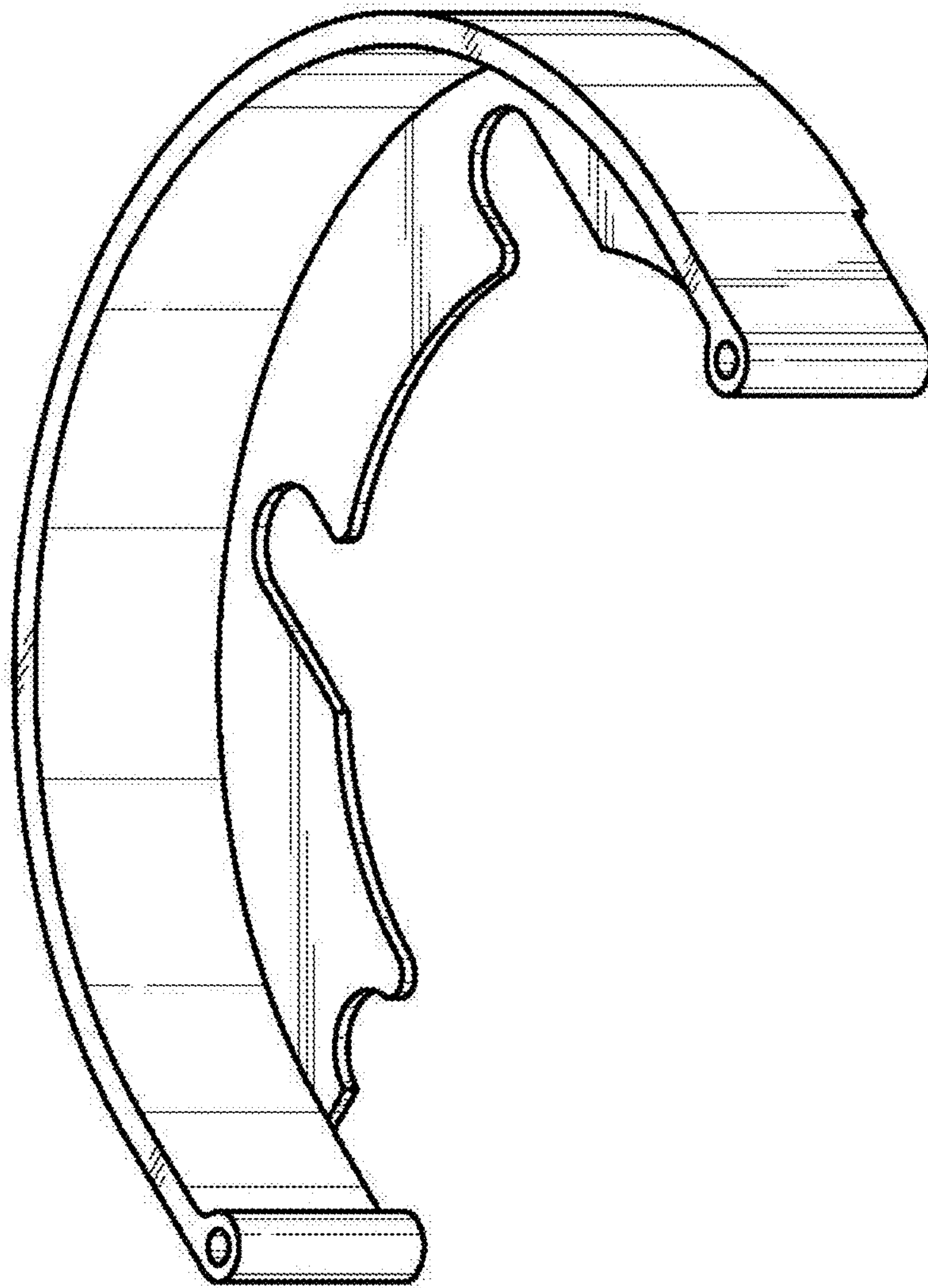

Fig. 2

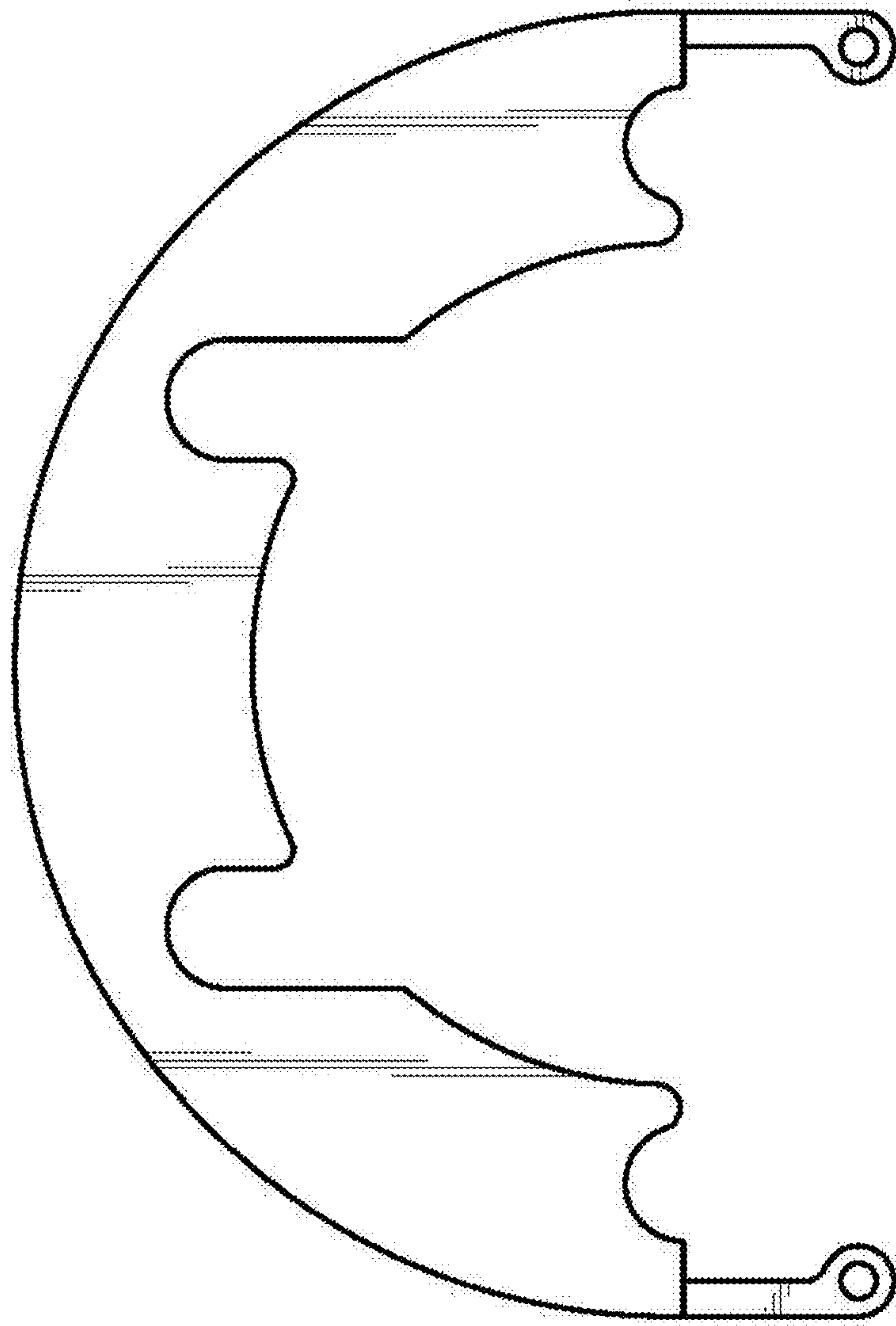

Fig. 3

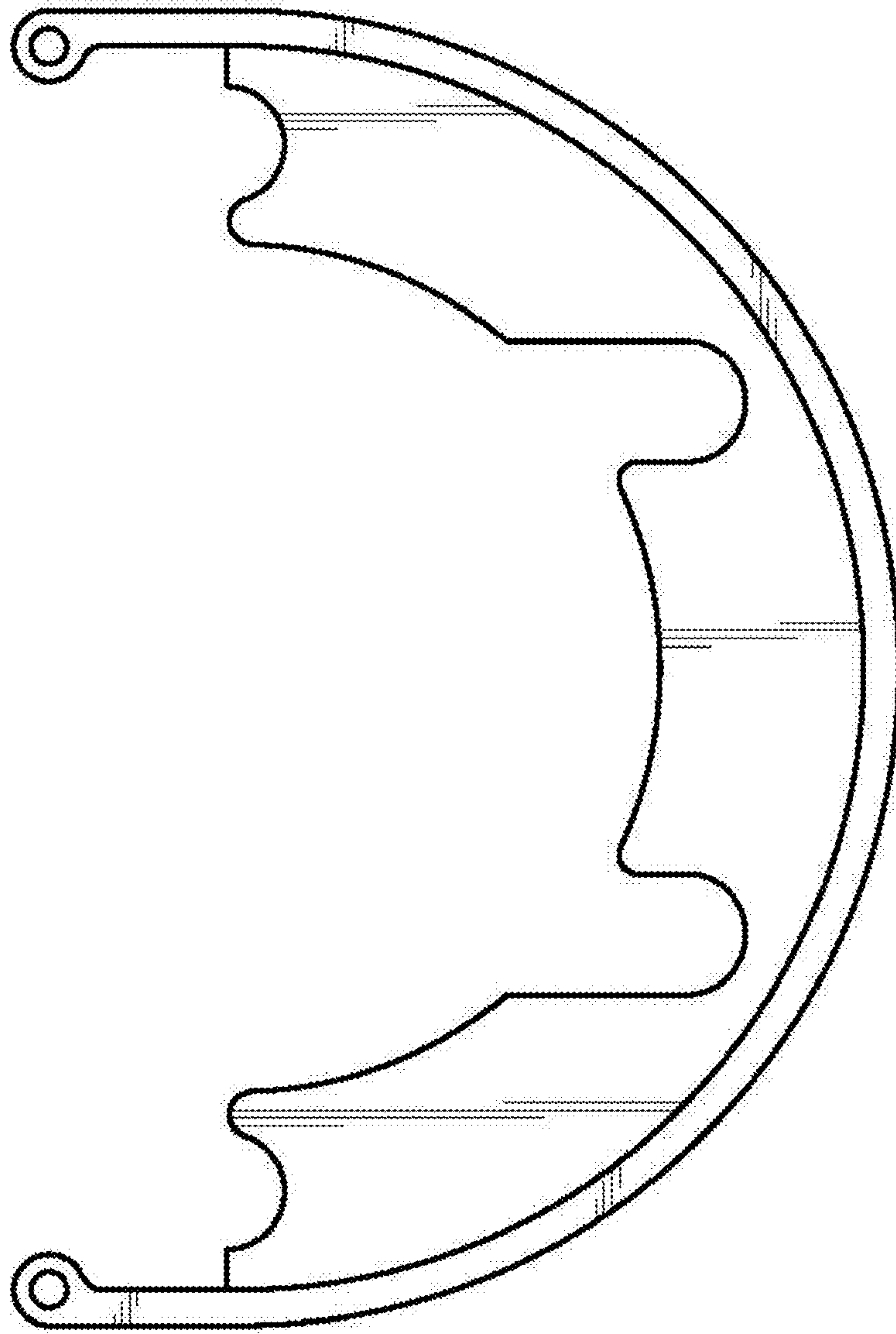

Fig. 4

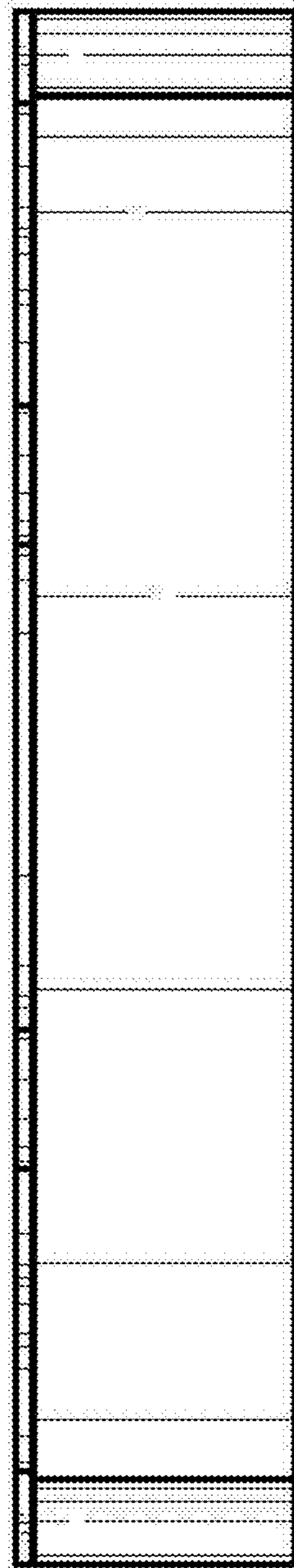

Fig. 5

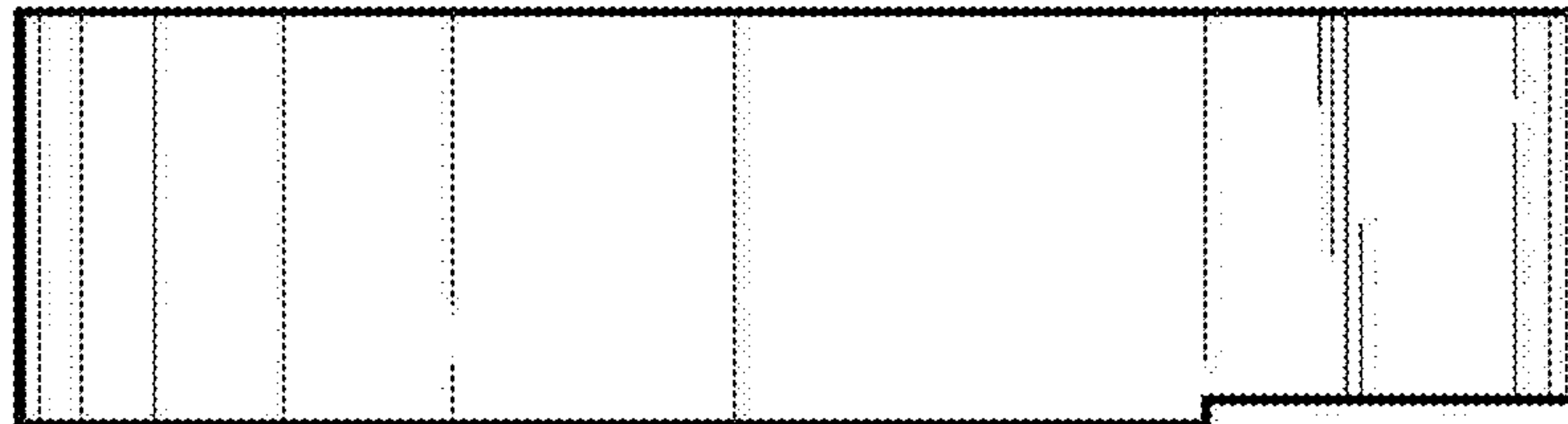

Fig. 6

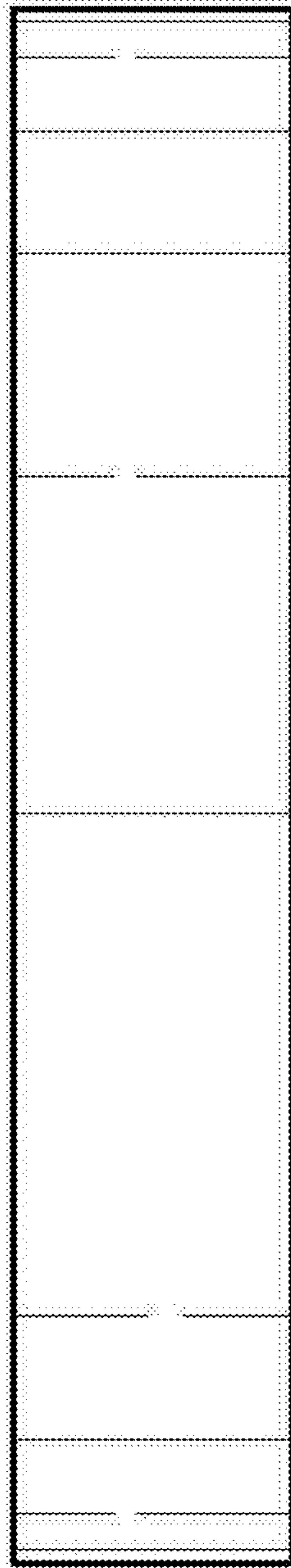

Fig. 7

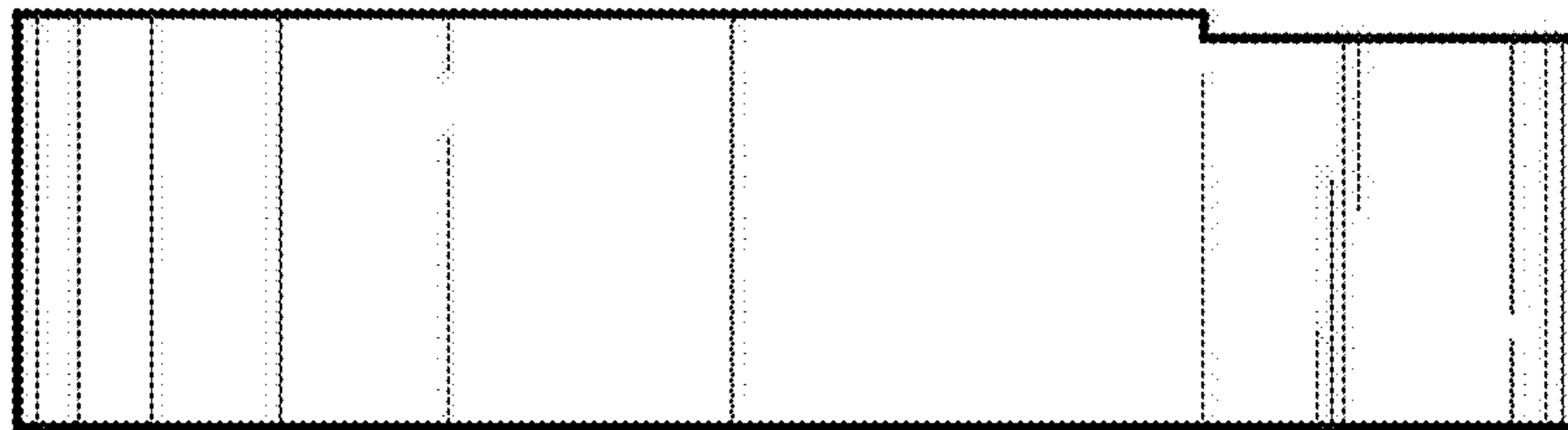

Fig. 8