



US00D856082S

(12) **United States Design Patent** (10) **Patent No.:** **US D856,082 S**  
**Yao** (45) **Date of Patent:** **\*\* Aug. 13, 2019**

(54) **BEVERAGE COOLER SET**

(74) *Attorney, Agent, or Firm* — Prakash Nama; Global IP Services, PLLC

(71) Applicant: **THE BOTTLE BOTTLE INC.**,  
Alhambra, CA (US)

(57) **CLAIM**

(72) Inventor: **Huajun Yao**, Hangzhou (CN)

The ornamental design for a beverage cooler set, as shown and described.

(\*\*) Term: **15 Years**

**DESCRIPTION**

(21) Appl. No.: **29/622,833**

(22) Filed: **Oct. 19, 2017**

(51) **LOC (12) Cl.** ..... **07-01**

(52) **U.S. Cl.**  
USPC ..... **D7/507**; D7/511; D7/523; D7/532;  
D8/34

(58) **Field of Classification Search**  
USPC ..... D7/505, 507, 509, 510, 511, 523, 532,  
D7/608, 300.1, 213, 392.1, 396.2, 387,  
D7/396.6, 624.1, 624.2; D9/500, 501,  
D9/502, 503, 504, 505, 516, 530, 556,  
D9/569, 537, 549, 557, 546; D14/216,  
D14/221, 204, 209.1, 215, 217, 212;  
D28/9, 76, 82, 88; D8/34  
CPC . A47G 19/2205; A47G 19/2272; A47J 43/27;  
A47J 41/02; A45F 3/16  
See application file for complete search history.

FIG. 1 is a front elevational view of a beverage cooler set showing my new design;  
FIG. 2 is a rear elevational view thereof;  
FIG. 3 is a left side view thereof;  
FIG. 4 is a right side view thereof;  
FIG. 5 is a top plan view thereof;  
FIG. 6 is a bottom plan view thereof;  
FIG. 7 is a perspective view thereof;  
FIG. 8 is another perspective view thereof;  
FIG. 9 is a front elevational view of a bottom portion of the beverage cooler set showing my new design, shown in an enlarged scale;  
FIG. 10 is a rear elevational view thereof;  
FIG. 11 is a left side view thereof;  
FIG. 12 is a right side view thereof;  
FIG. 13 is a top plan view thereof;  
FIG. 14 is a bottom plan view thereof;  
FIG. 15 is a perspective view thereof;  
FIG. 16 is another perspective view thereof;  
FIG. 17 is a front elevational view of an upper portion of the beverage cooler set showing my new design, shown in an enlarged scale;  
FIG. 18 is a rear elevational view thereof;  
FIG. 19 is a left side view thereof;  
FIG. 20 is a right side view thereof;  
FIG. 21 is a top plan view thereof;  
FIG. 22 is a bottom plan view thereof;  
FIG. 23 is a perspective view thereof; and,  
FIG. 24 is another perspective view thereof.  
The broken lines in the drawings depict portions of the beverage cooler set that form no part of the claimed design.

(56) **References Cited**

**U.S. PATENT DOCUMENTS**

D406,025 S	*	2/1999	Hung	81/3.09
D450,223 S	*	11/2001	Jørgensen	D7/608
D506,910 S	*	7/2005	Tham-itthisak	D7/509
D599,619 S	*	9/2009	Bodum	D7/509
D721,924 S	*	2/2015	Trafton	D7/507
D745,398 S	*	12/2015	Cotton	D9/500
D774,827 S	*	12/2016	Miller	D7/507
D798,359 S	*	9/2017	Huang	D16/203

(Continued)

*Primary Examiner* — Marianne N Pandozzi

*Assistant Examiner* — Jae Liang

**1 Claim, 23 Drawing Sheets**

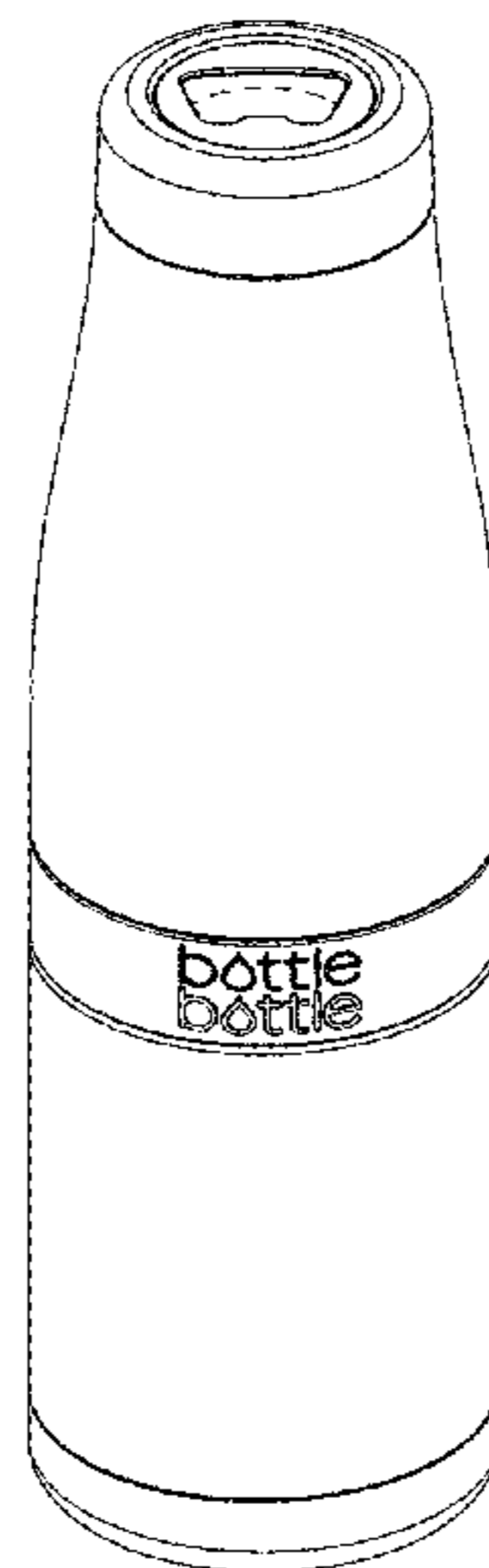

(56)

**References Cited**

U.S. PATENT DOCUMENTS

D812,478 S \* 3/2018 Hines ..... D9/500  
D826,052 S \* 8/2018 Harris ..... D9/500  
D830,784 S \* 10/2018 Moore ..... D7/608  
D832,651 S \* 11/2018 Wiet ..... D7/511  
2009/0255941 A1 \* 10/2009 Kuntz ..... B65D 23/0885  
220/592.17  
2018/0312322 A1 \* 11/2018 Canales Kell ..... B65D 81/3283

\* cited by examiner

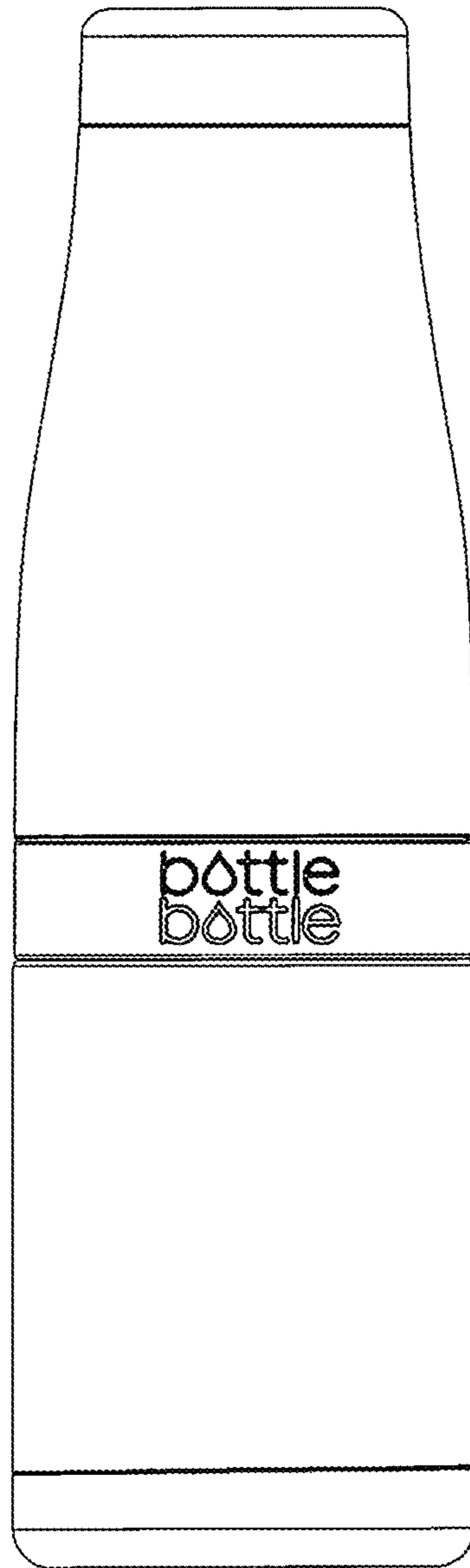

FIG.1

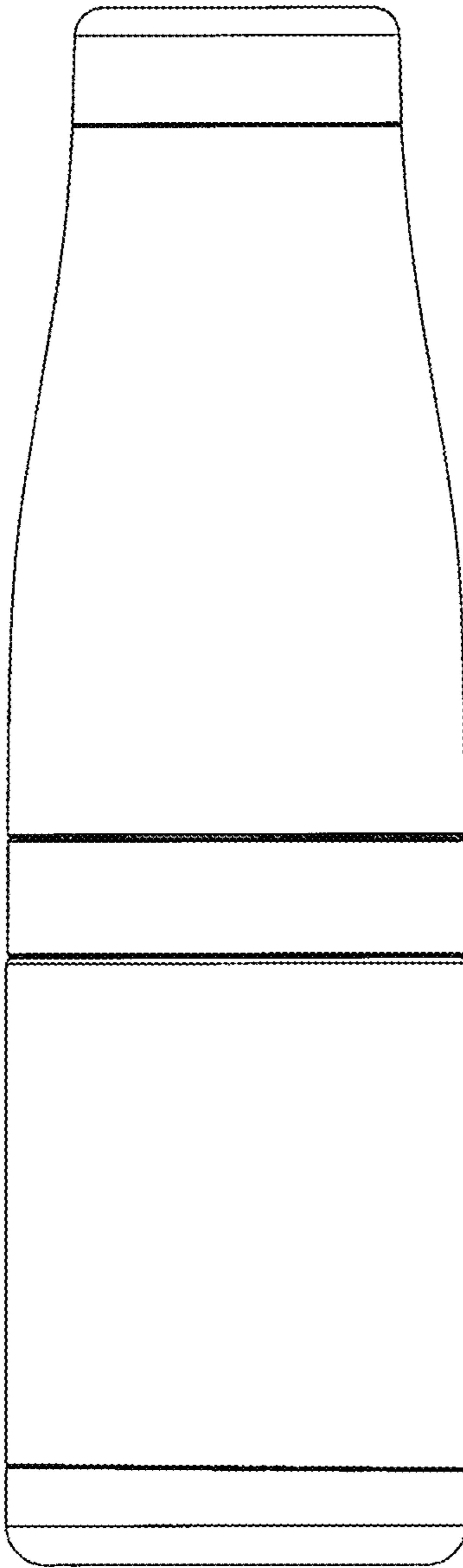

FIG.2

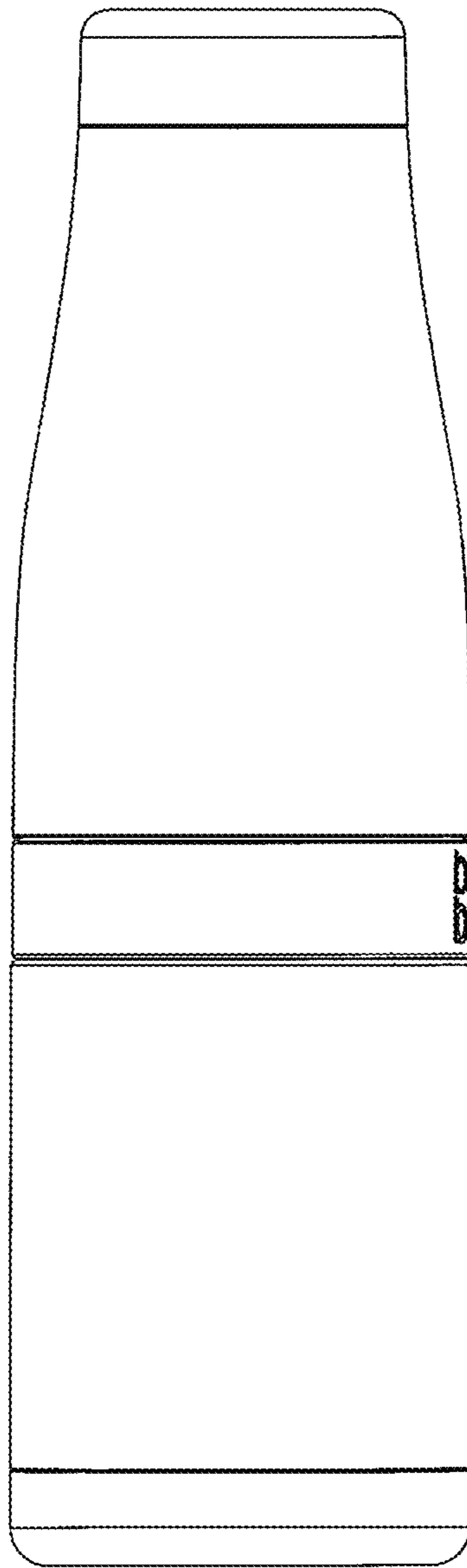

FIG.3

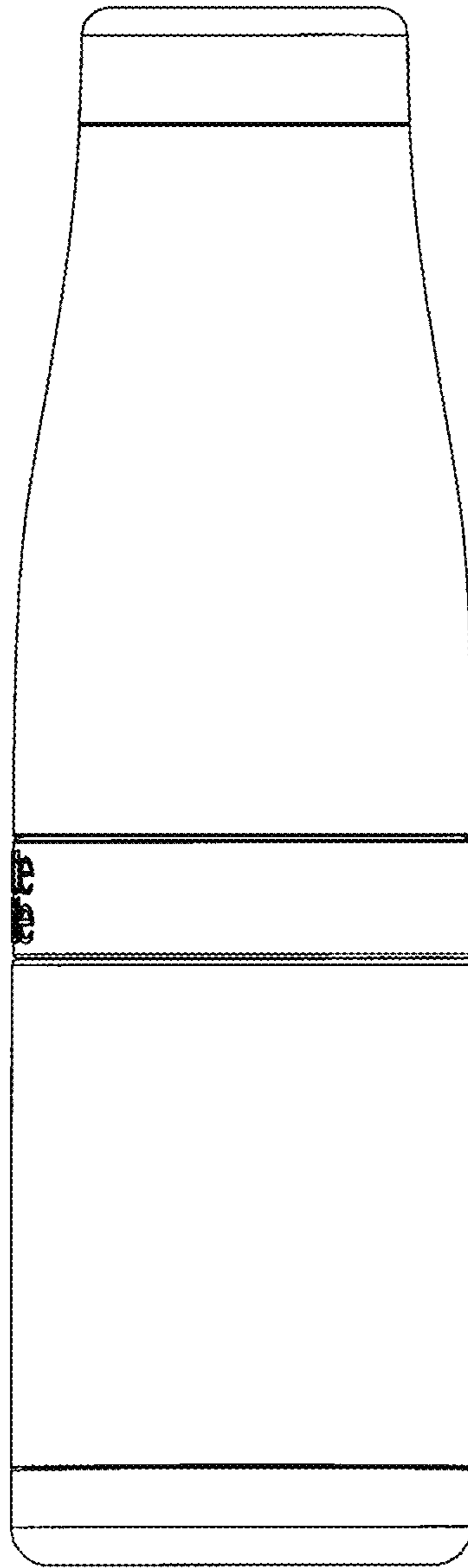

FIG.4

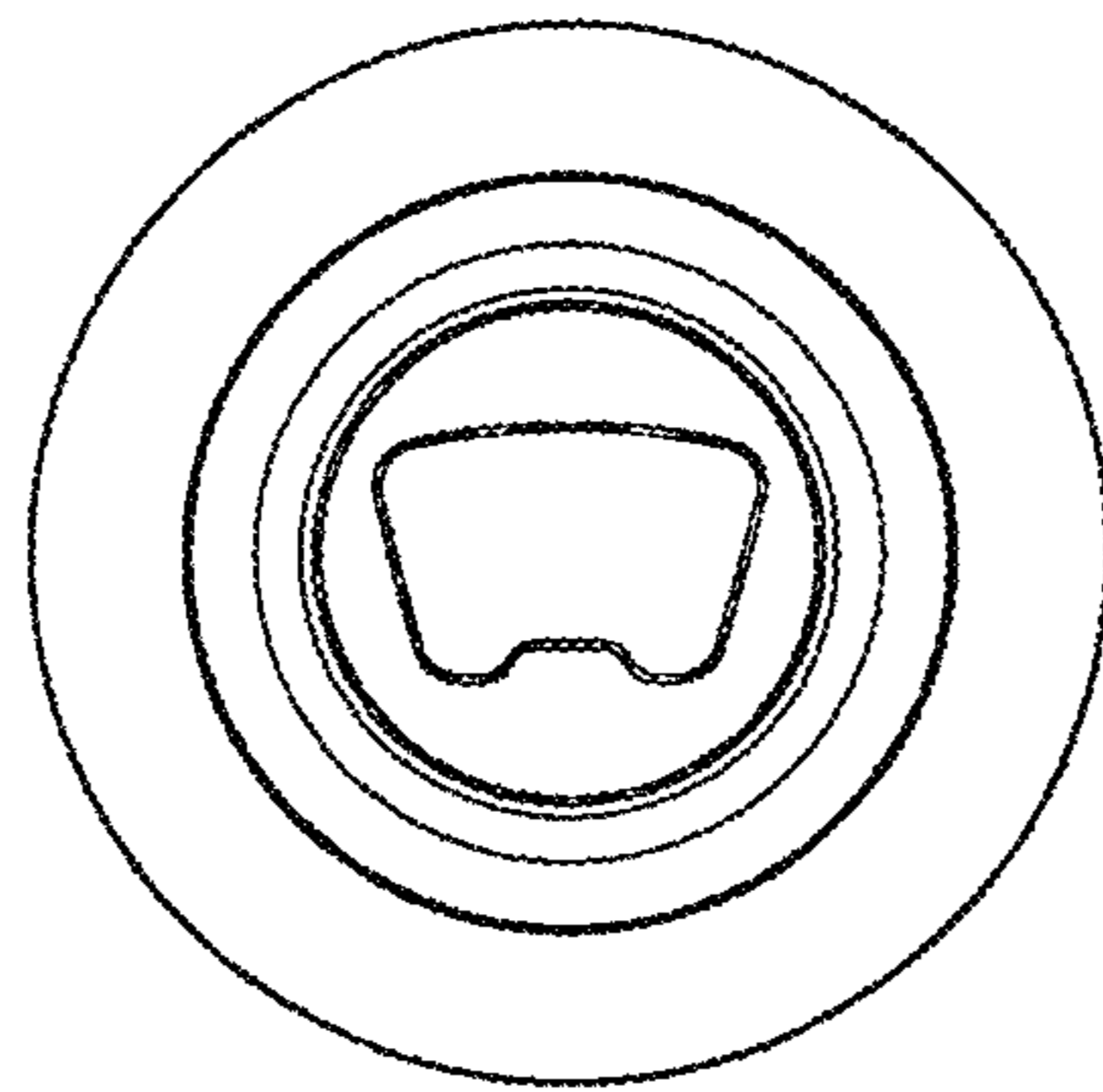

FIG. 5

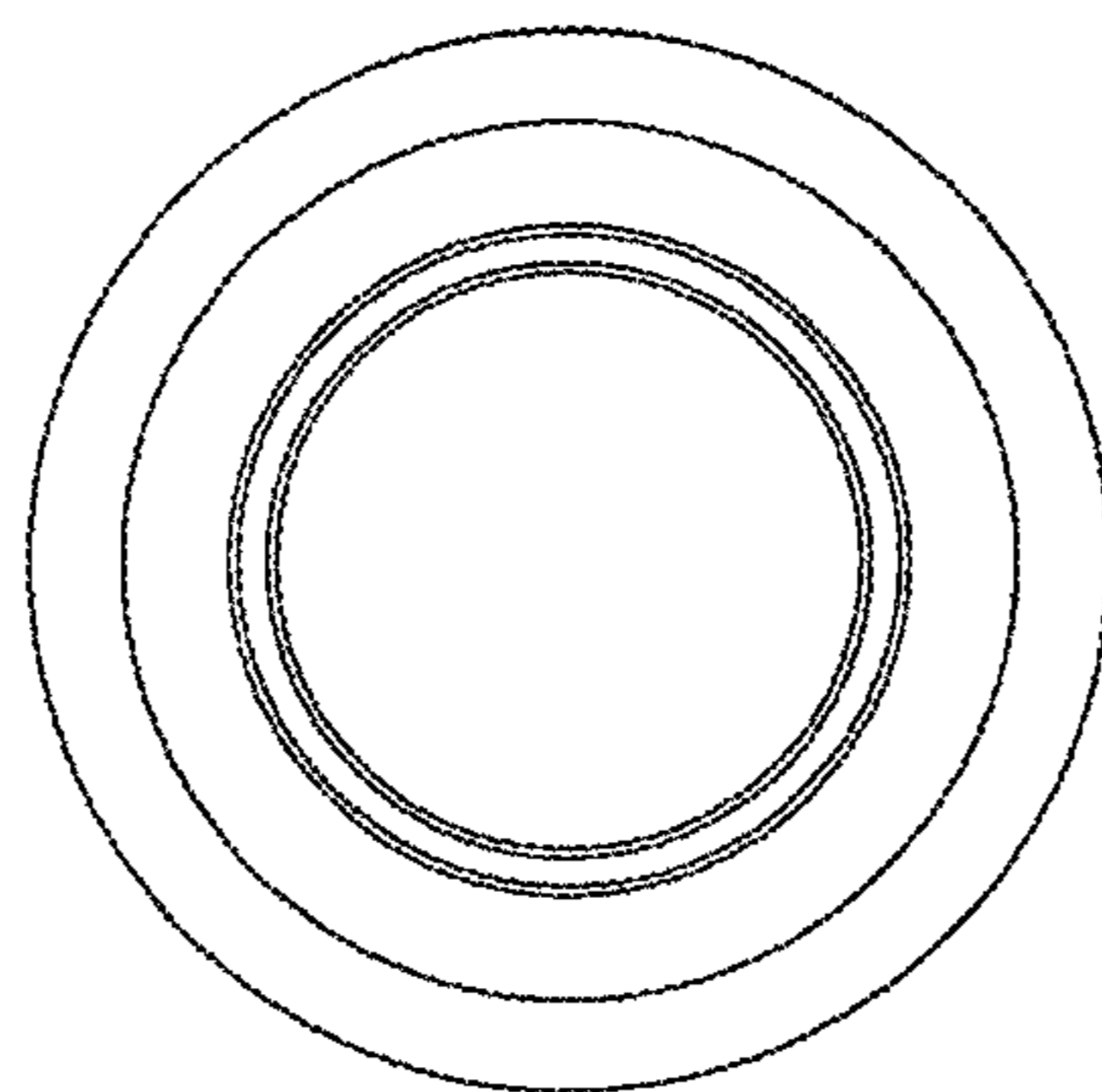

FIG. 6

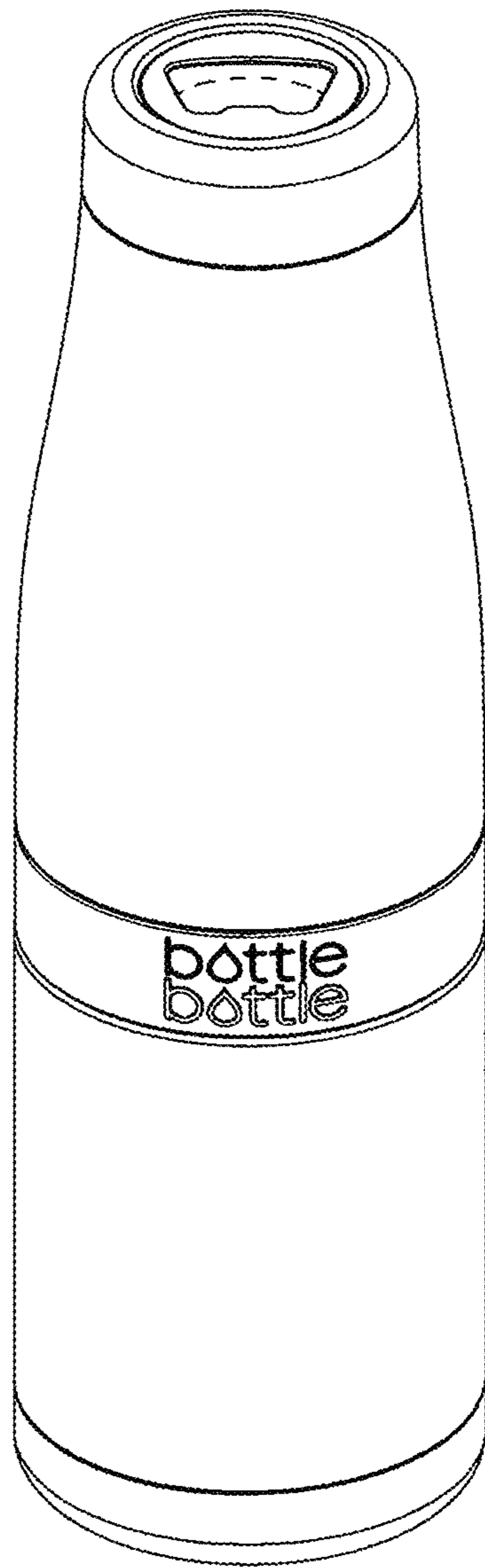

FIG.7



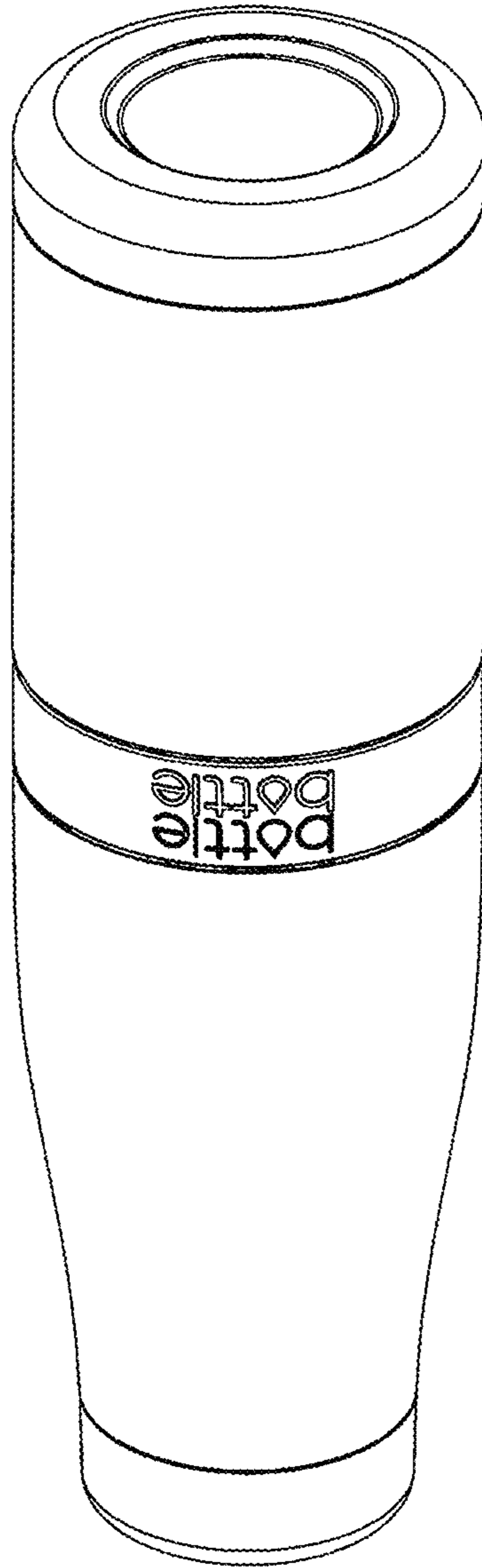

FIG.8

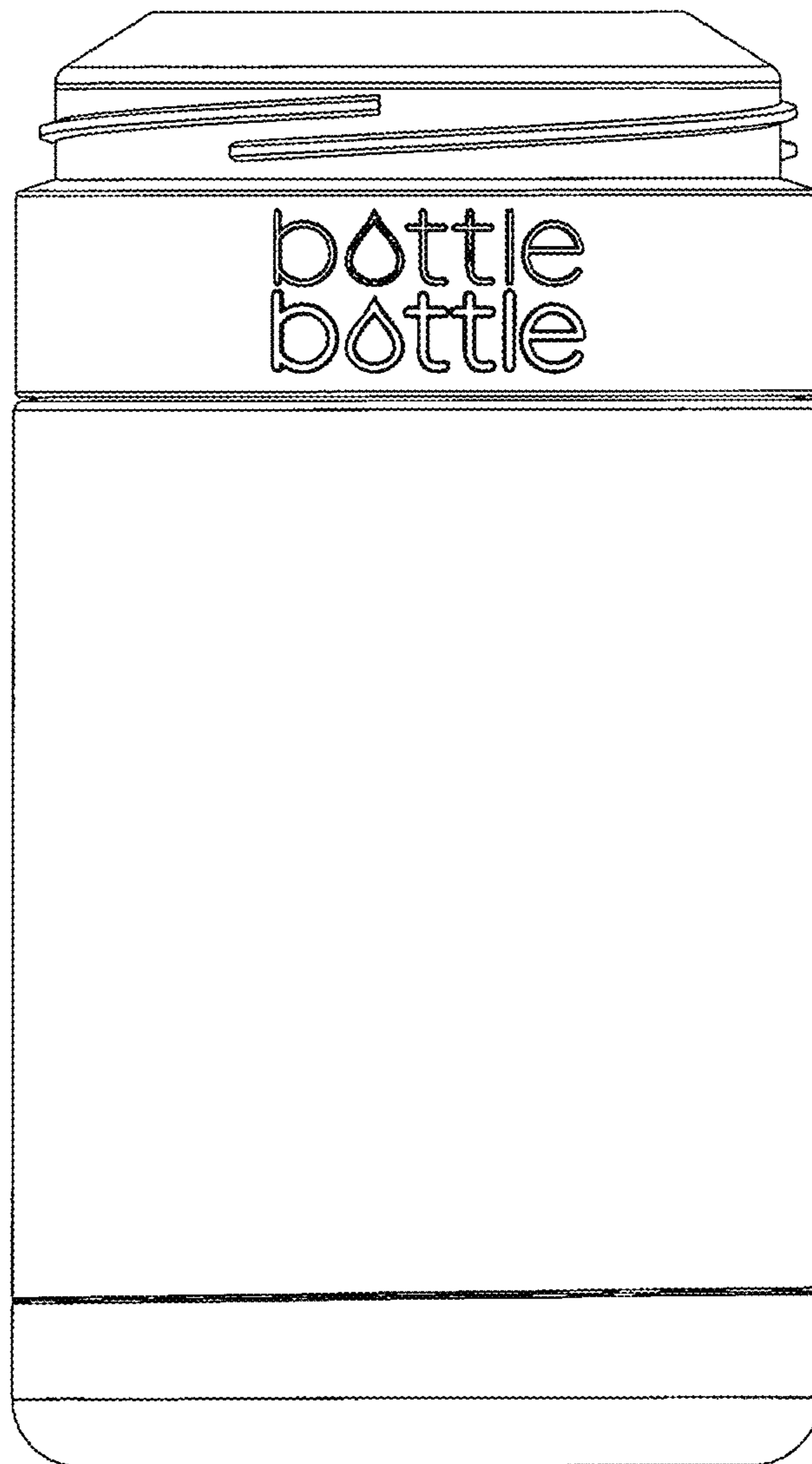

FIG.9

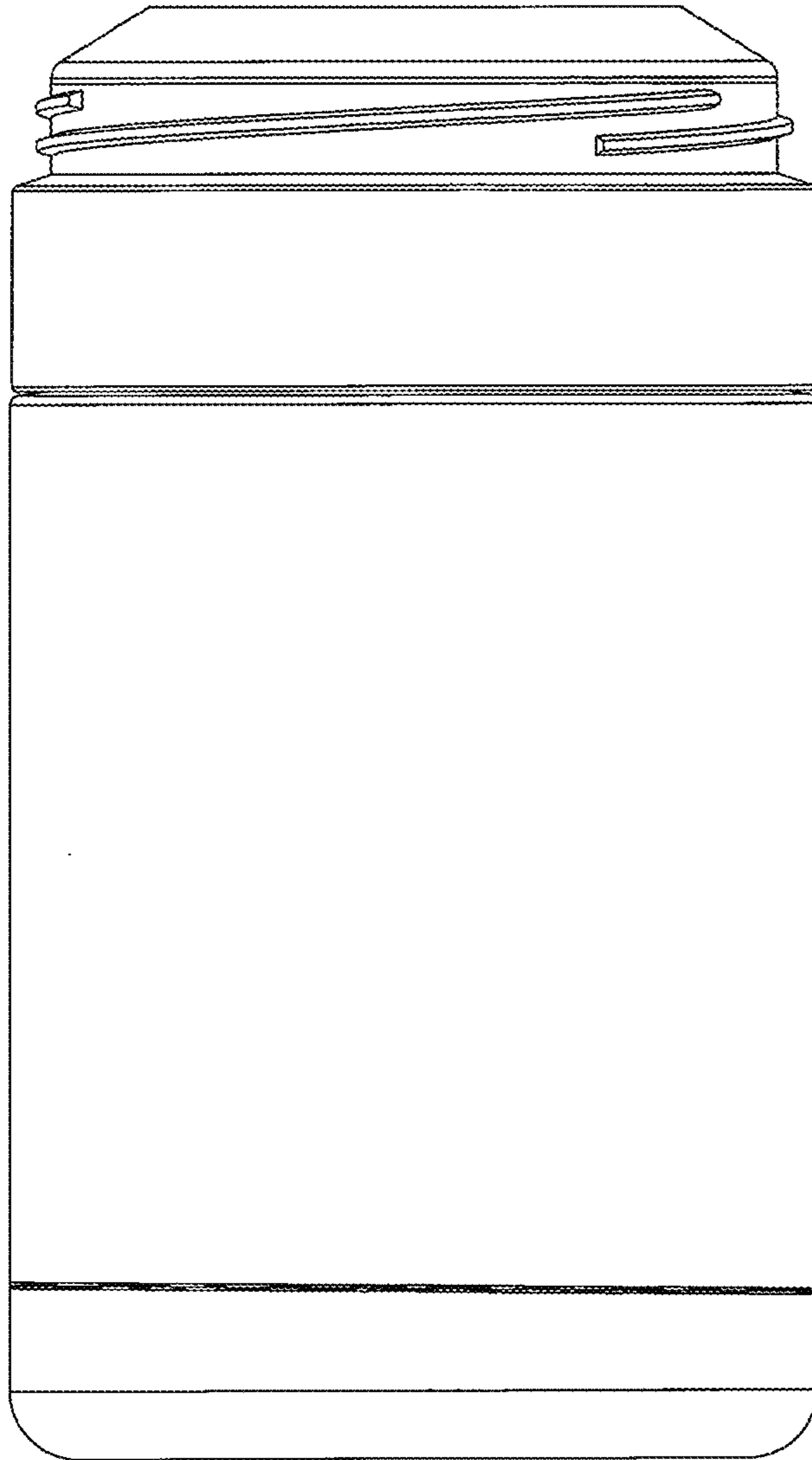

FIG. 10

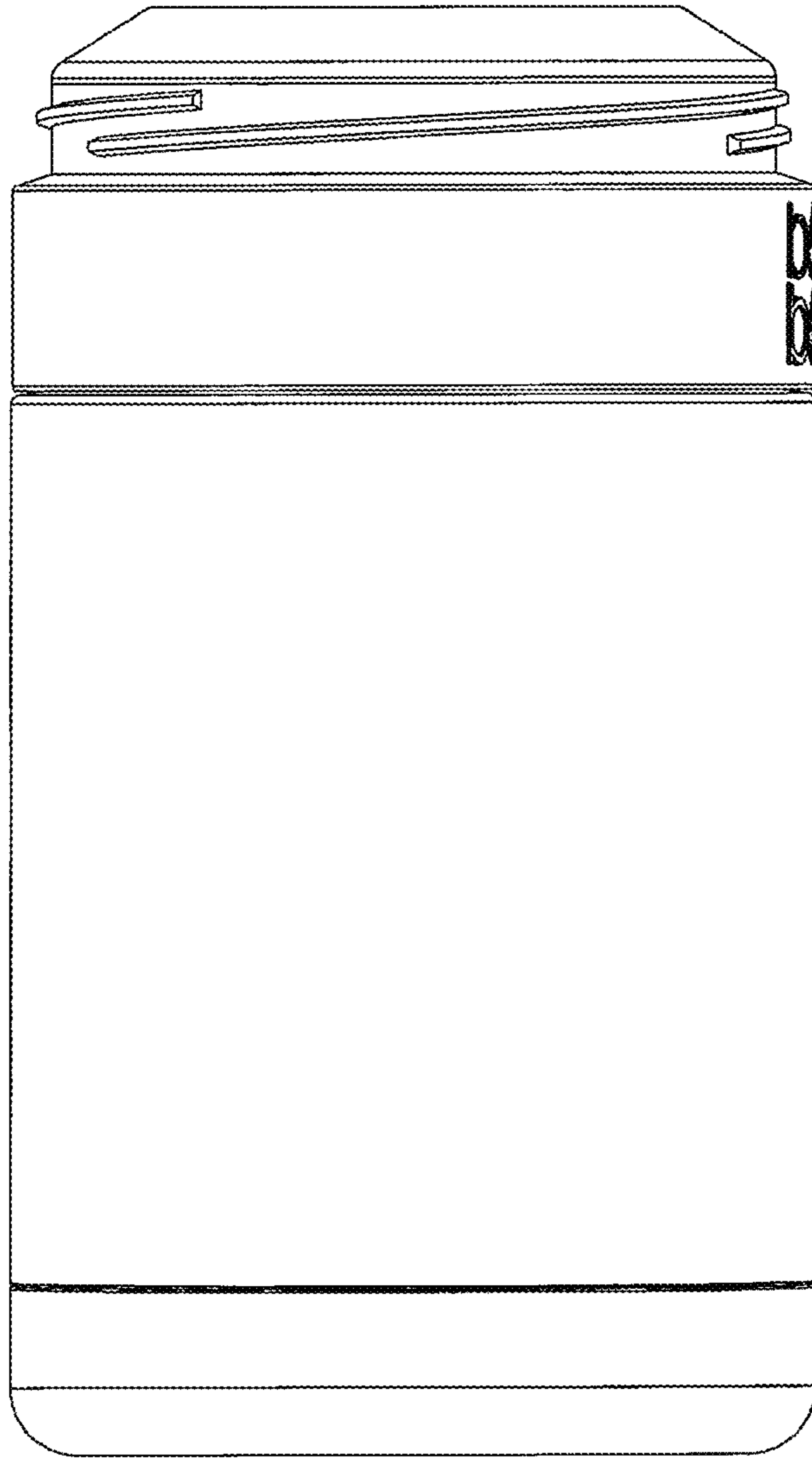

FIG.11

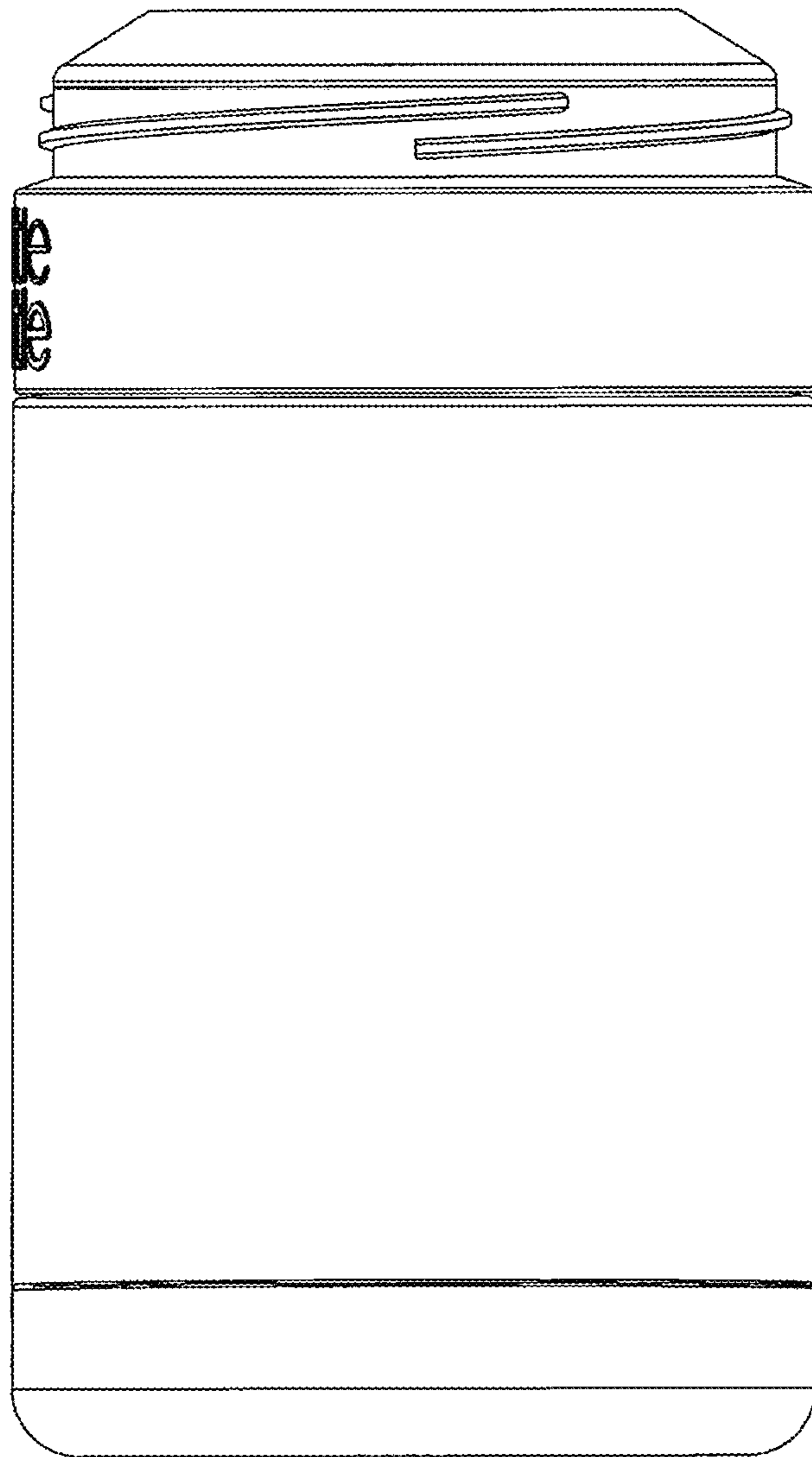

FIG. 12

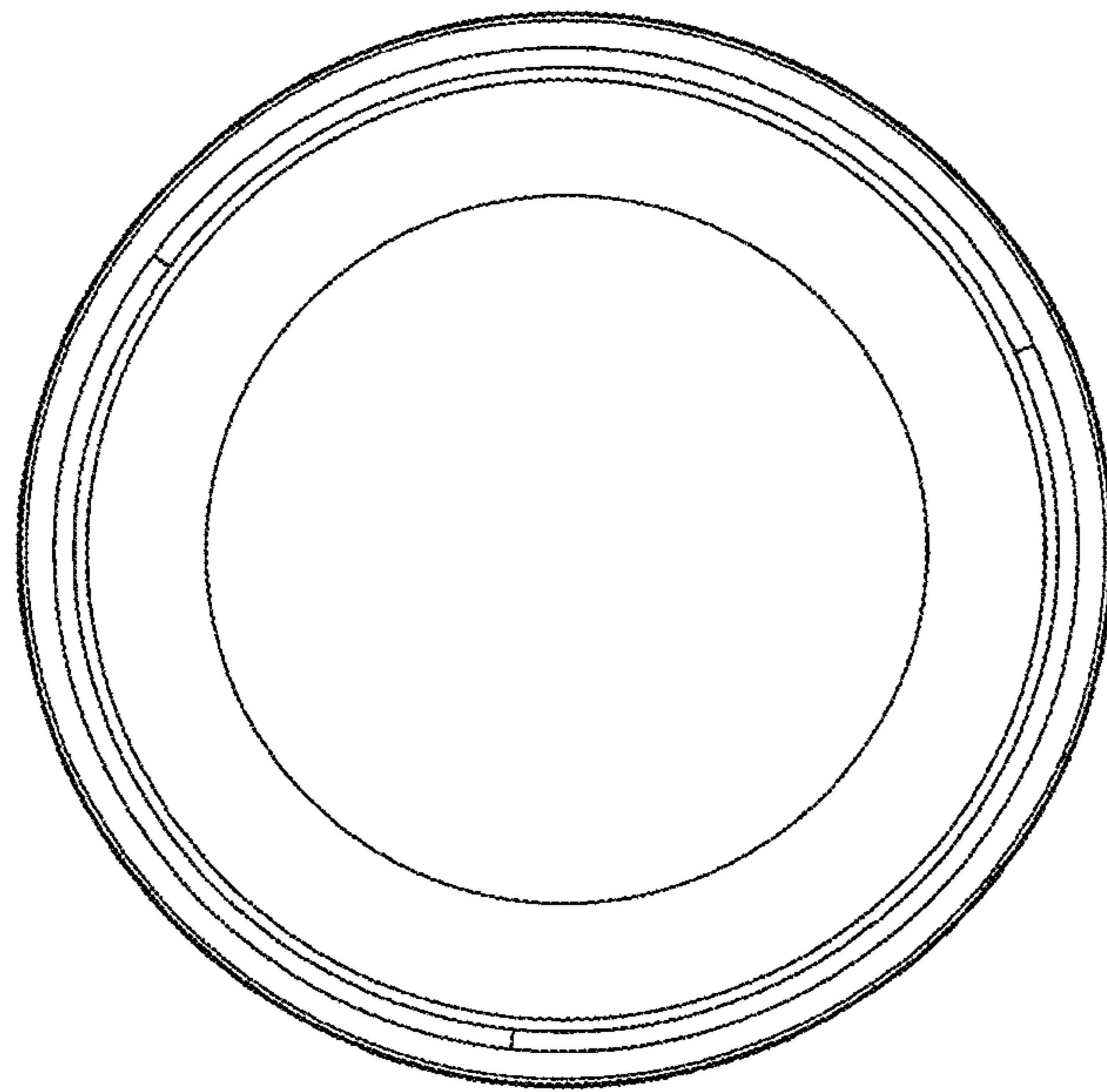

FIG.13

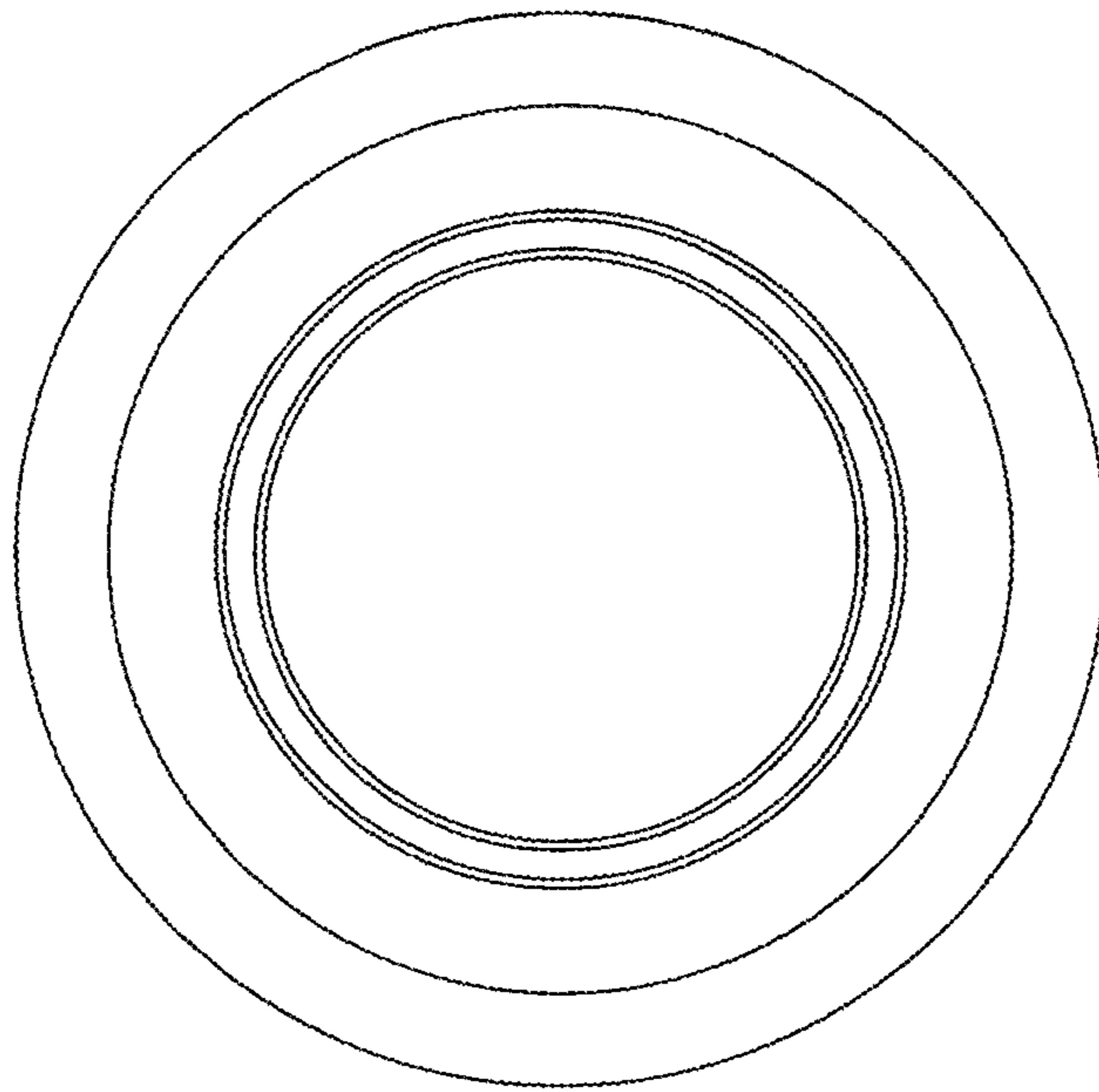

FIG.14

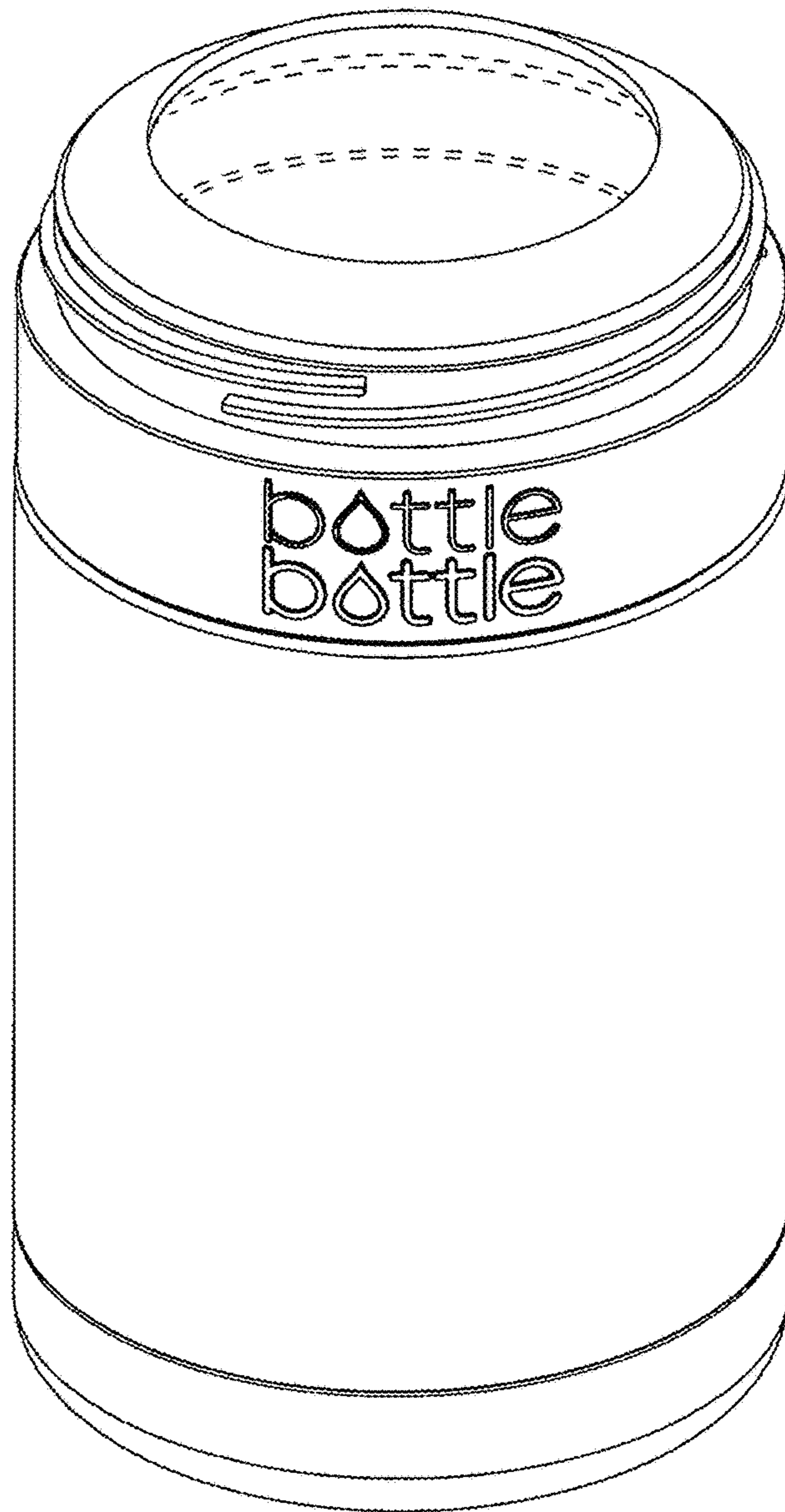

FIG.15



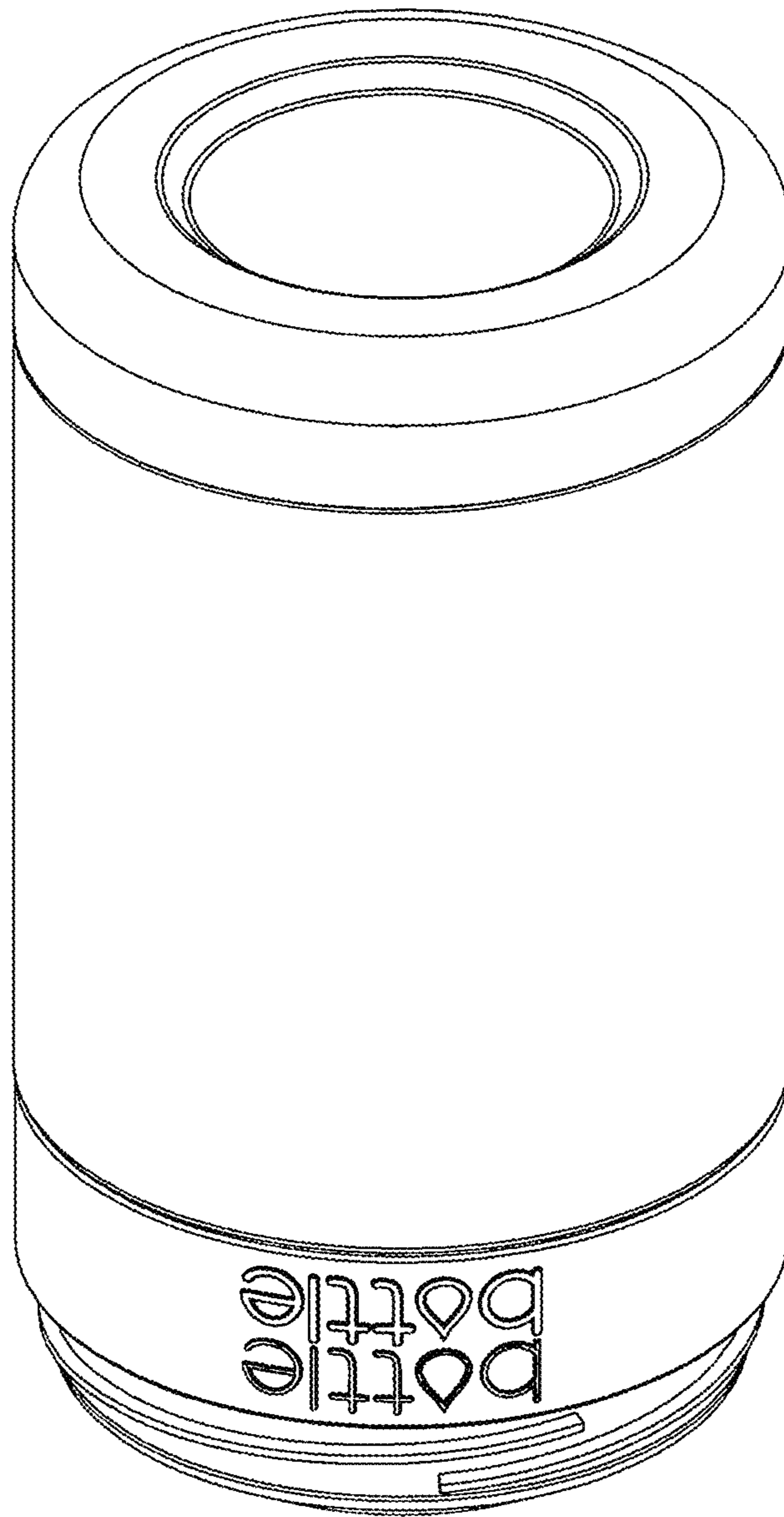

FIG. 16

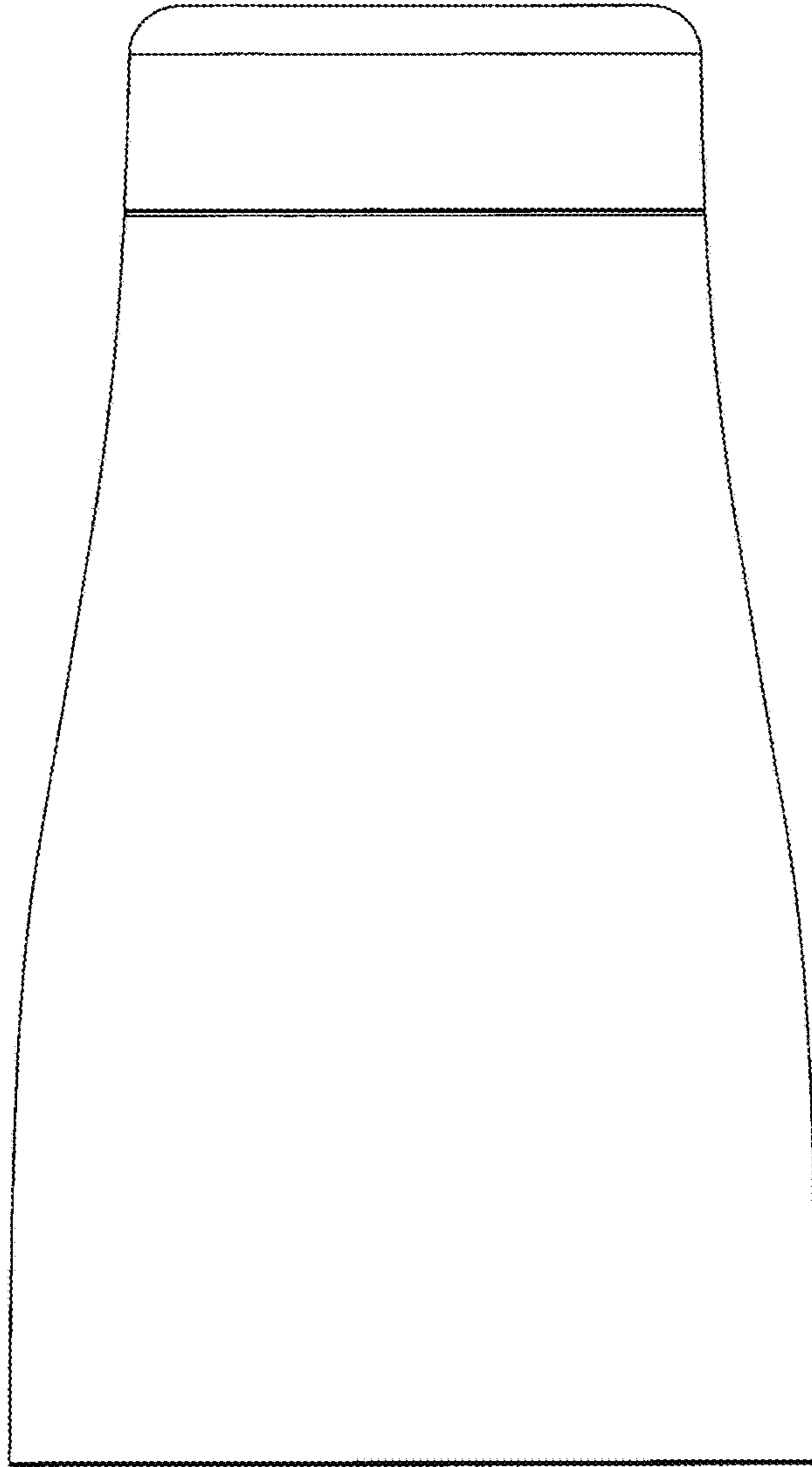

FIG.17

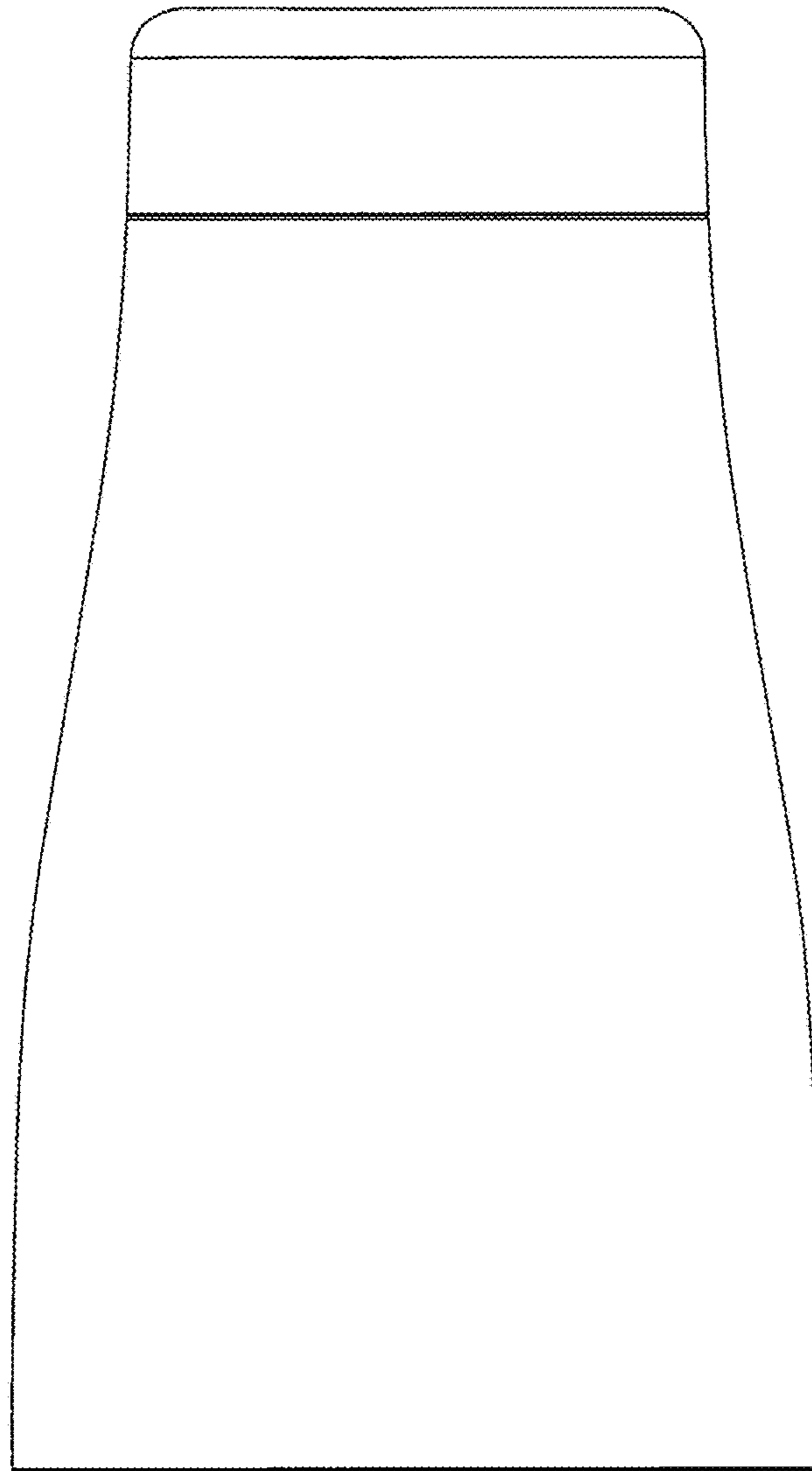

FIG.18

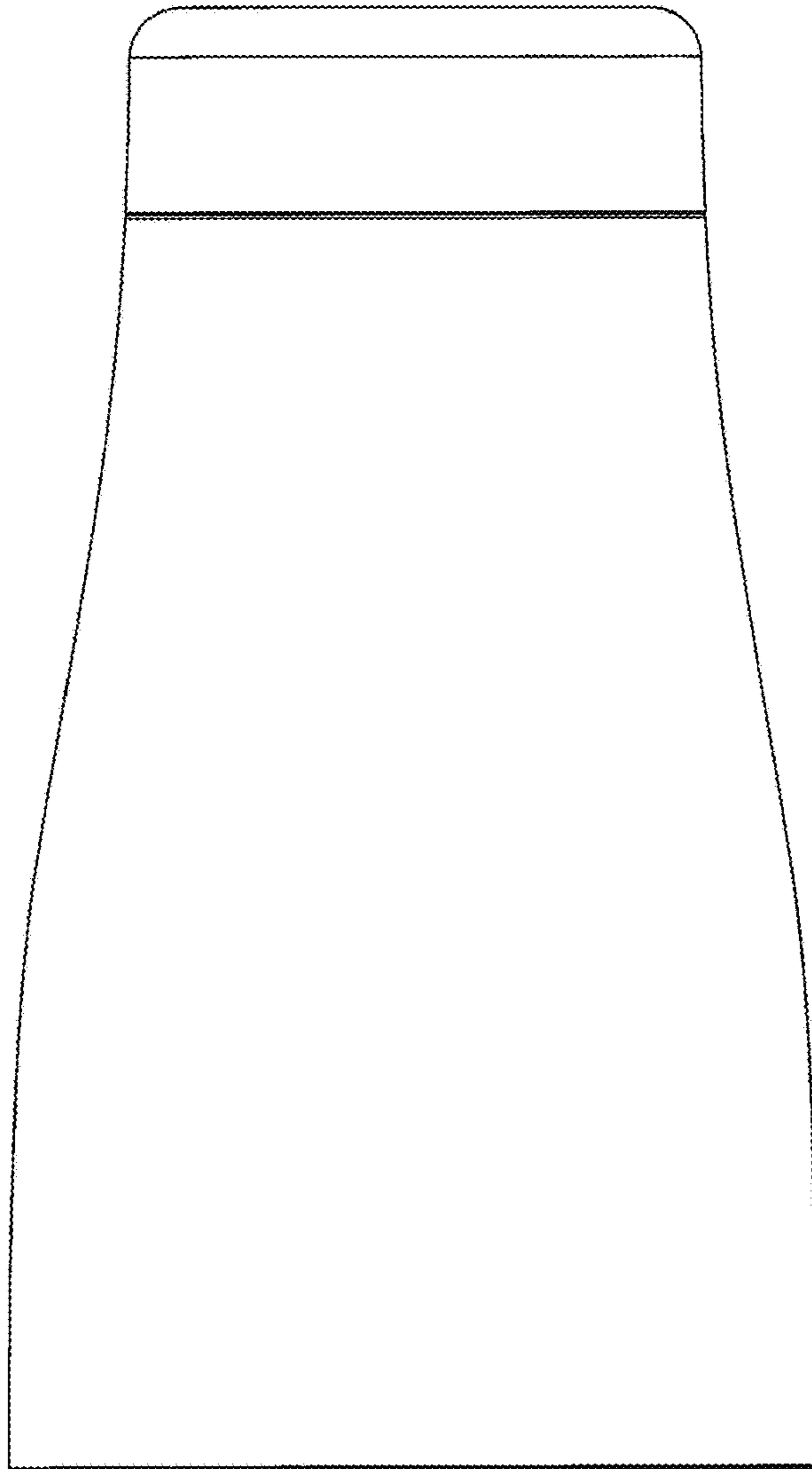

FIG.19

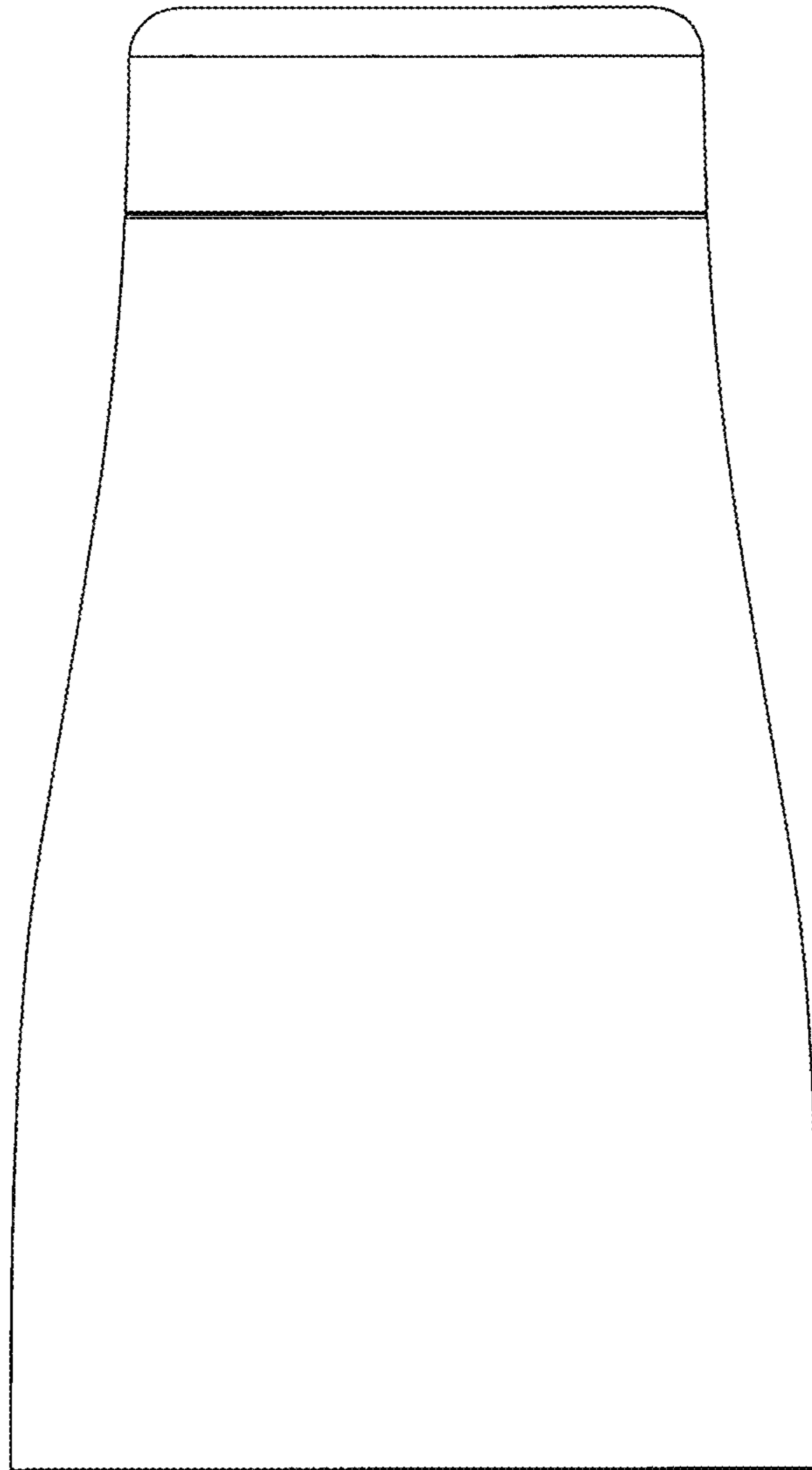

FIG.20

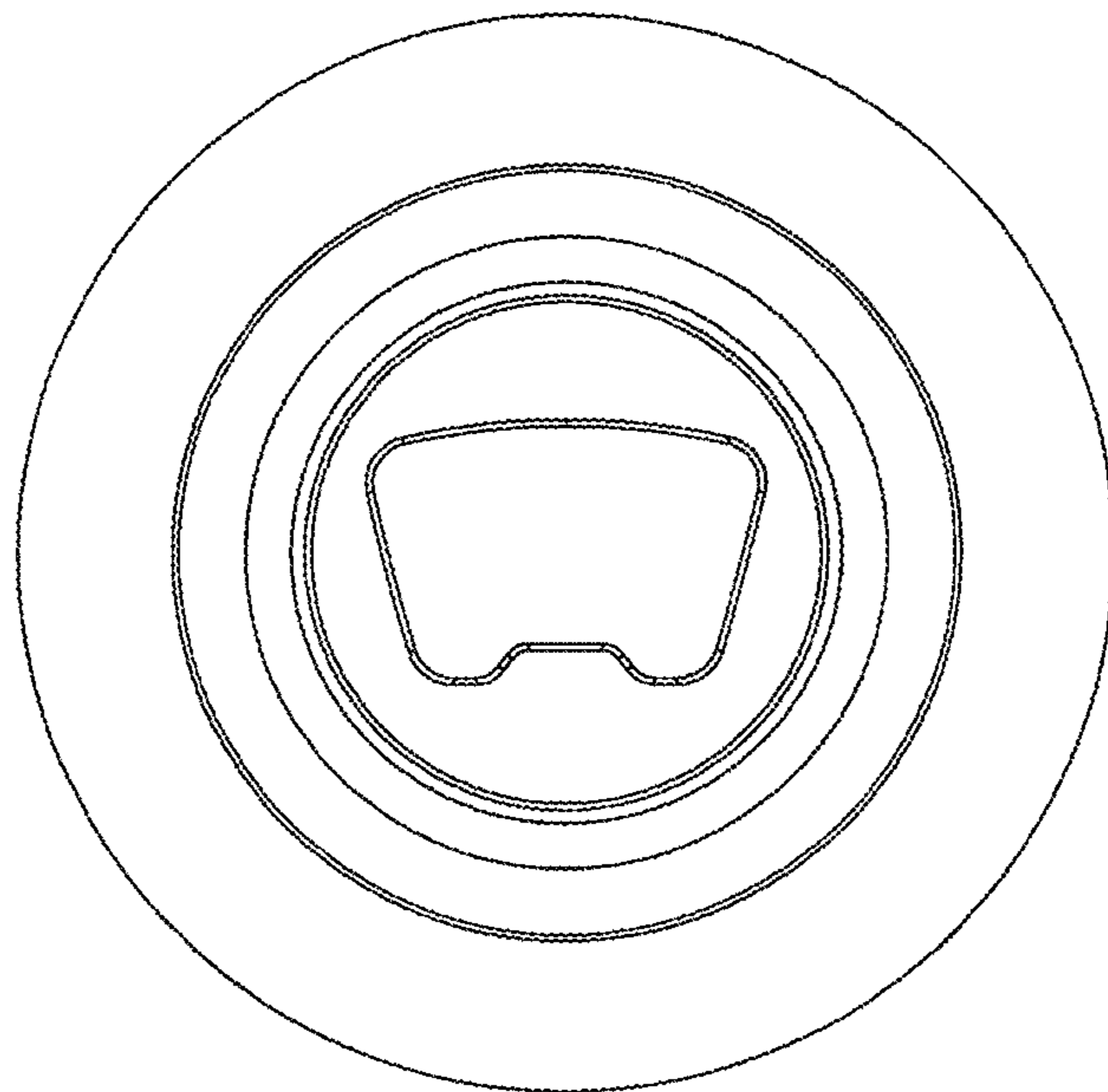

FIG.21

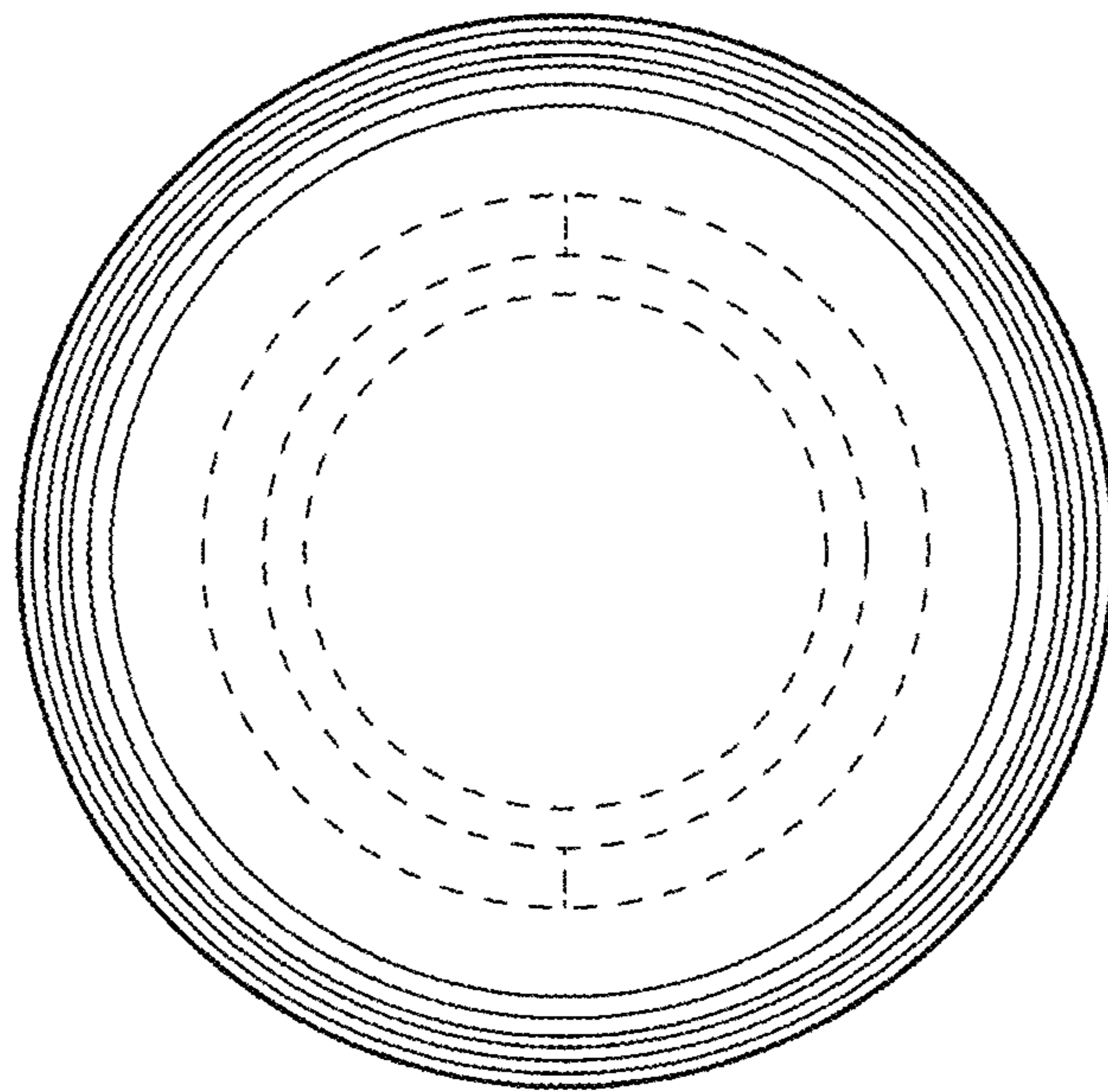

FIG.22

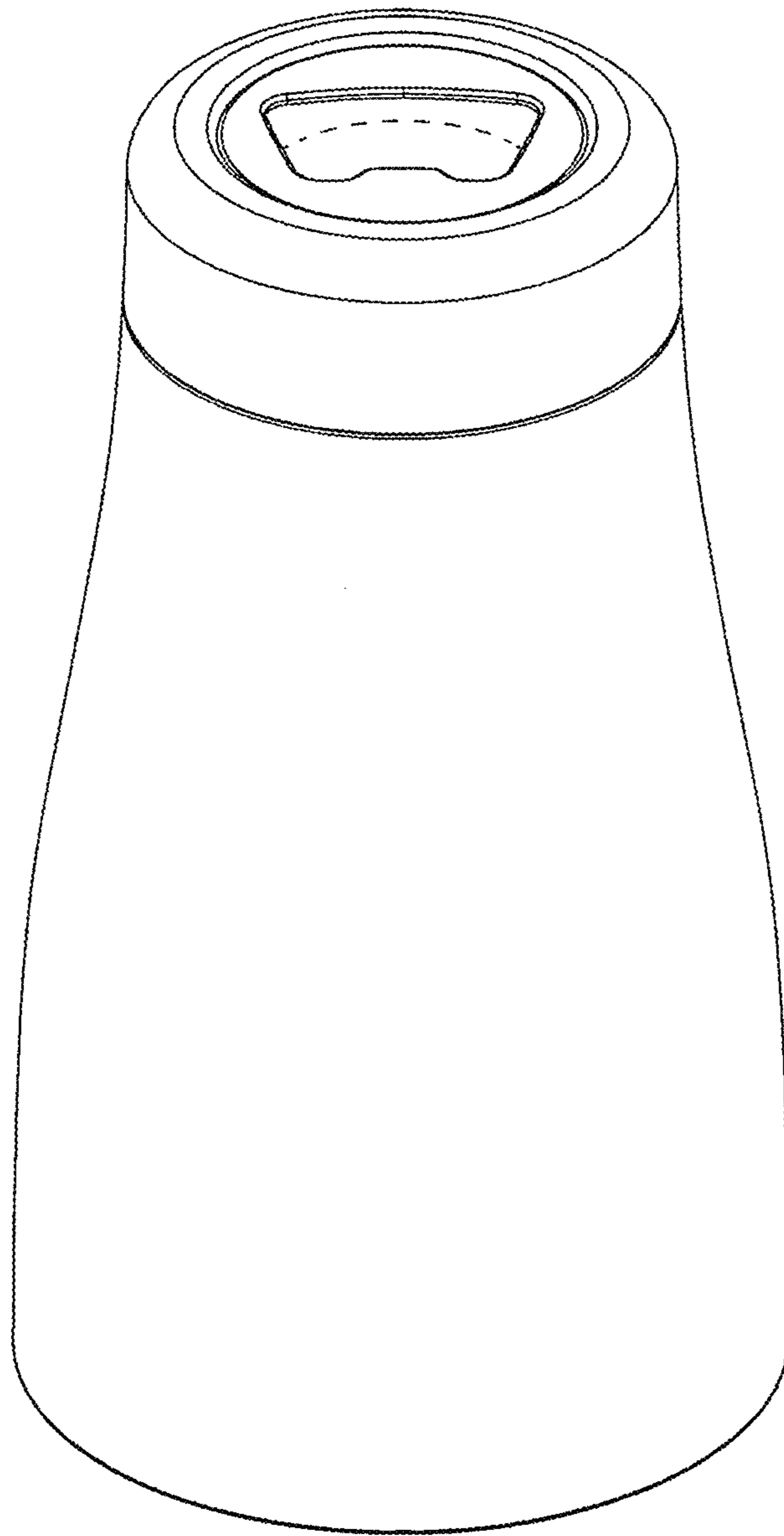

FIG. 23



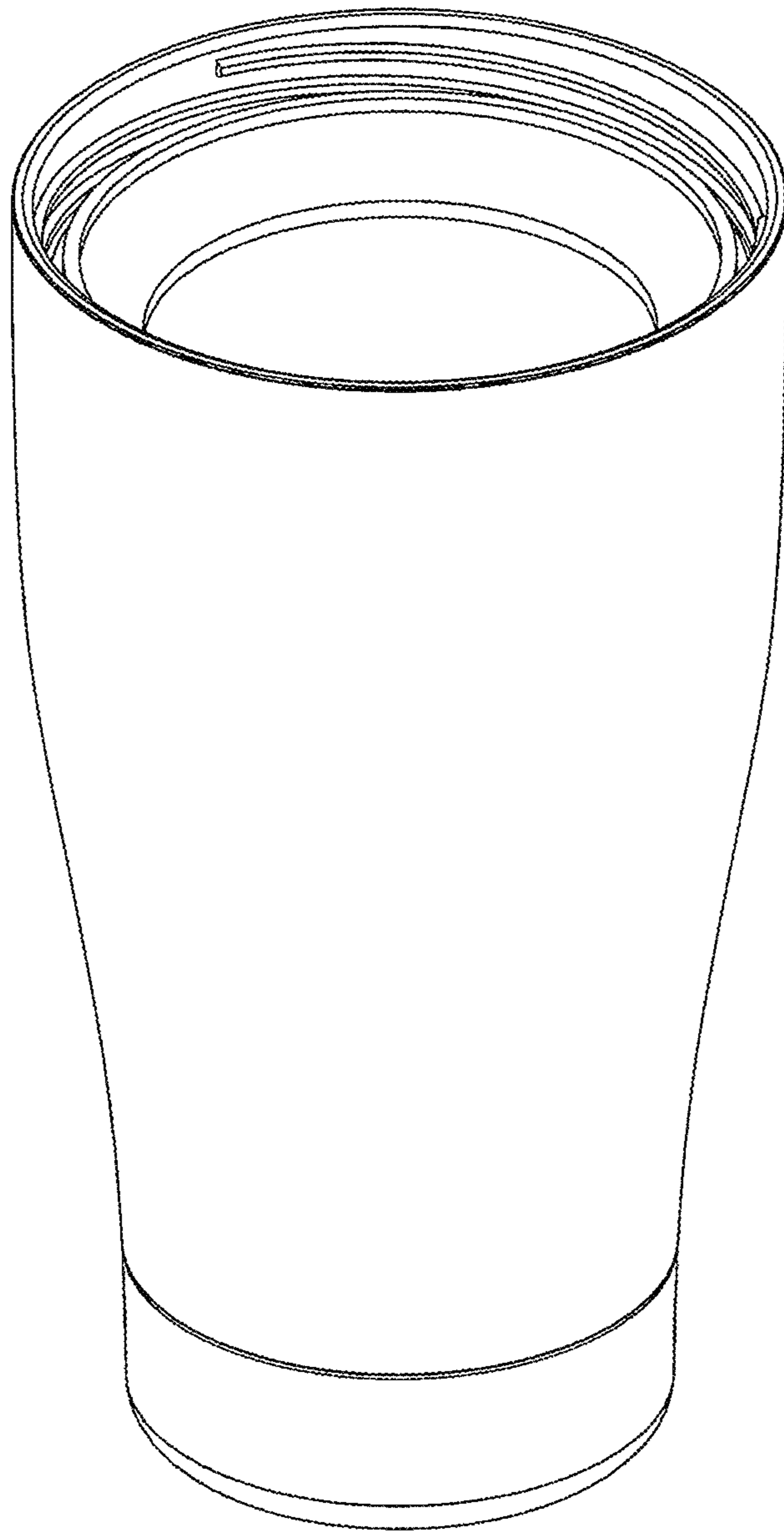

FIG.24