



US00D855978S

(12) **United States Design Patent**  
**Rahardjo**

(10) **Patent No.:** **US D855,978 S**

(45) **Date of Patent:** **\*\* Aug. 13, 2019**

(54) **HANDBAG**

(71) Applicant: **Sri Rahardjo**, Singapore (SG)

(72) Inventor: **Sri Rahardjo**, Singapore (SG)

(\*\*) Term: **15 Years**

(21) Appl. No.: **29/640,045**

(22) Filed: **Mar. 12, 2018**

(51) **LOC (12) Cl.** ..... **03-01**

(52) **U.S. Cl.**  
USPC ..... **D3/243**

(58) **Field of Classification Search**  
USPC ..... D3/232–233, 240–243, 245–246  
CPC ..... A45C 1/024; A45C 3/06  
See application file for complete search history.

(56) **References Cited**

**U.S. PATENT DOCUMENTS**

D422,405	S	*	4/2000	du Sartel	.....	D3/232
D498,360	S	*	11/2004	de Baschmakoff	.....	D3/243
D524,045	S	*	7/2006	Handley	.....	D3/243
D661,894	S	*	6/2012	Sassi	.....	D3/245
D767,270	S	*	9/2016	Maier	.....	D3/243
D767,884	S	*	10/2016	Venturini Fendi	.....	D3/243
D792,093	S	*	7/2017	Venturini Fendi	.....	D3/243
D794,326	S	*	8/2017	Nair	.....	D3/243
D803,555	S	*	11/2017	Maier	.....	D3/243
D813,533	S	*	3/2018	de Haan	.....	D3/243
D816,330	S	*	5/2018	Nair	.....	D3/243
D831,346	S	*	10/2018	Nair	.....	D3/243
D833,739	S	*	11/2018	Sassi	.....	D3/243

\* cited by examiner

*Primary Examiner* — Holly H Baynham

(74) *Attorney, Agent, or Firm* — Ziegler IP Law Group, LLC

(57) **CLAIM**

The ornamental design for a handbag, as shown and described.

**DESCRIPTION**

FIG. 1 is a perspective view of a first embodiment of a handbag showing the new design;  
 FIG. 2 is a front view thereof;  
 FIG. 3 is a back view thereof;  
 FIG. 4 is a top view thereof;  
 FIG. 5 is a bottom view thereof;  
 FIG. 6 is a side view thereof;  
 FIG. 7 is another side view thereof, shown from the side opposite that shown in FIG. 6;  
 FIG. 8 is a perspective view of a second embodiment of the handbag showing the new design;  
 FIG. 9 is a front view thereof;  
 FIG. 10 is a back view thereof;  
 FIG. 11 is a top view thereof;  
 FIG. 12 is a bottom view thereof;  
 FIG. 13 is a side view thereof; and,  
 FIG. 14 is another side view thereof, shown from the side opposite that shown in FIG. 13.  
 The broken lines showing stitching are for the purposes of illustrating environment and forms no part of the claimed design.

**1 Claim, 10 Drawing Sheets**

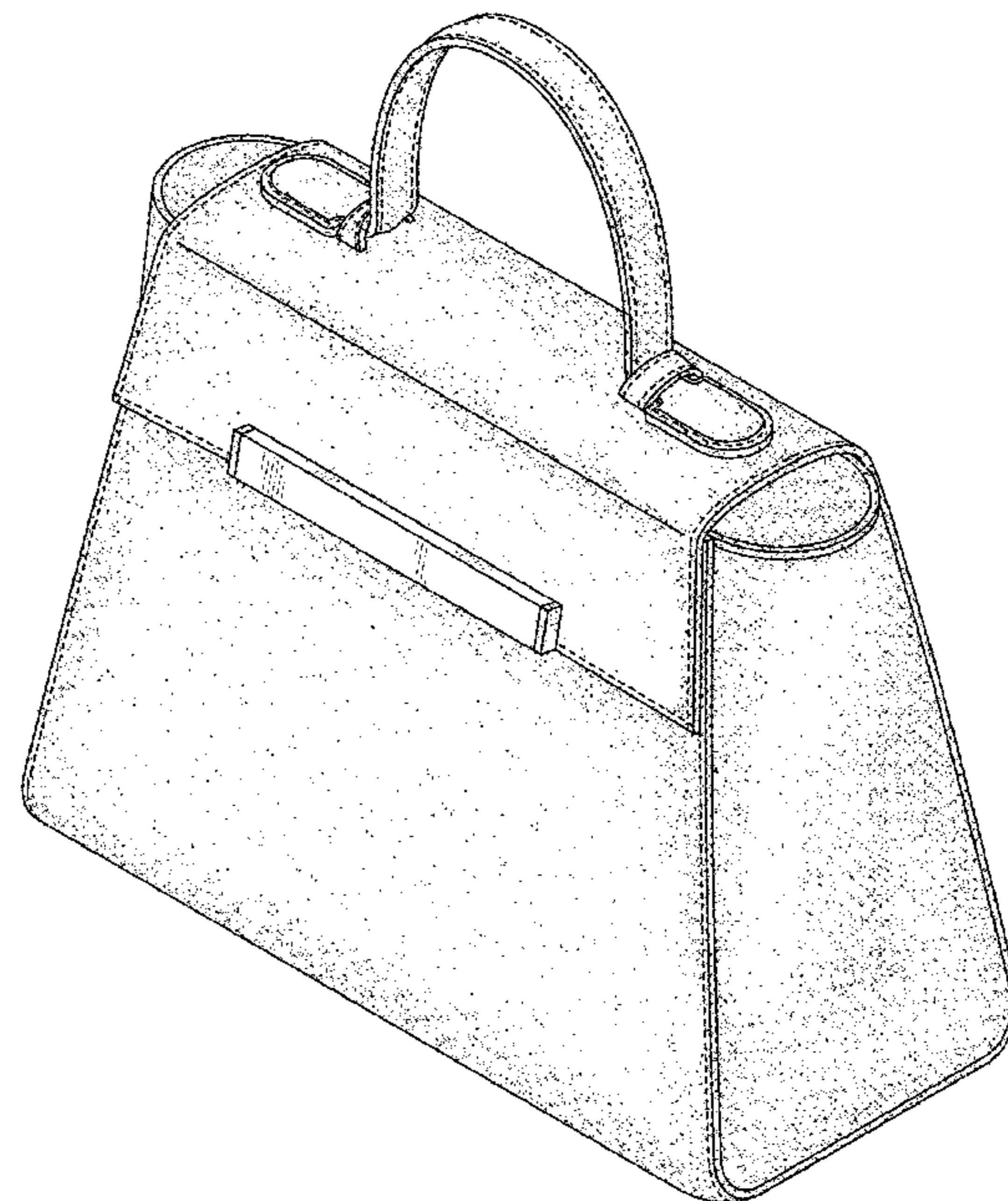



FIG. 1

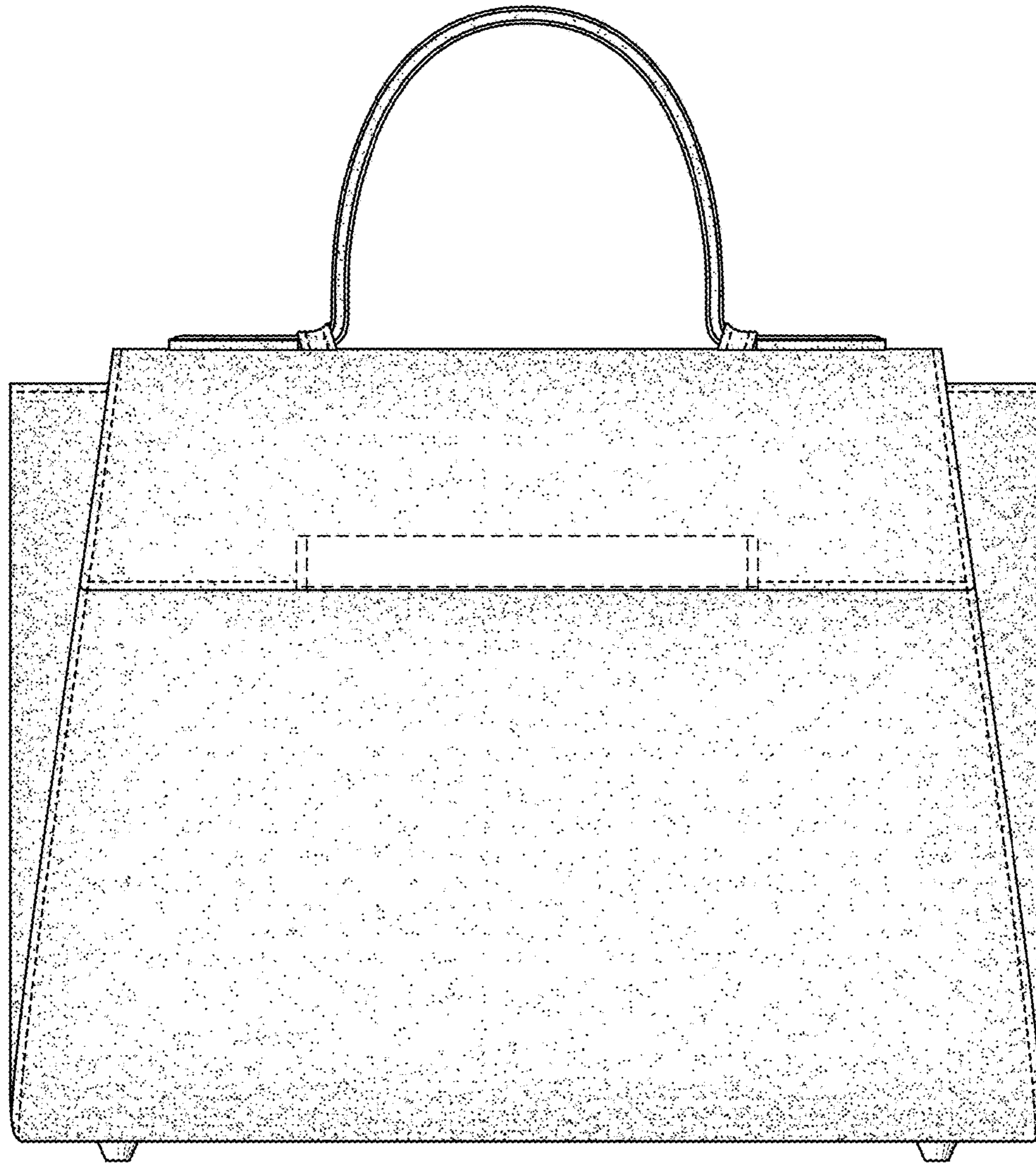

FIG. 2

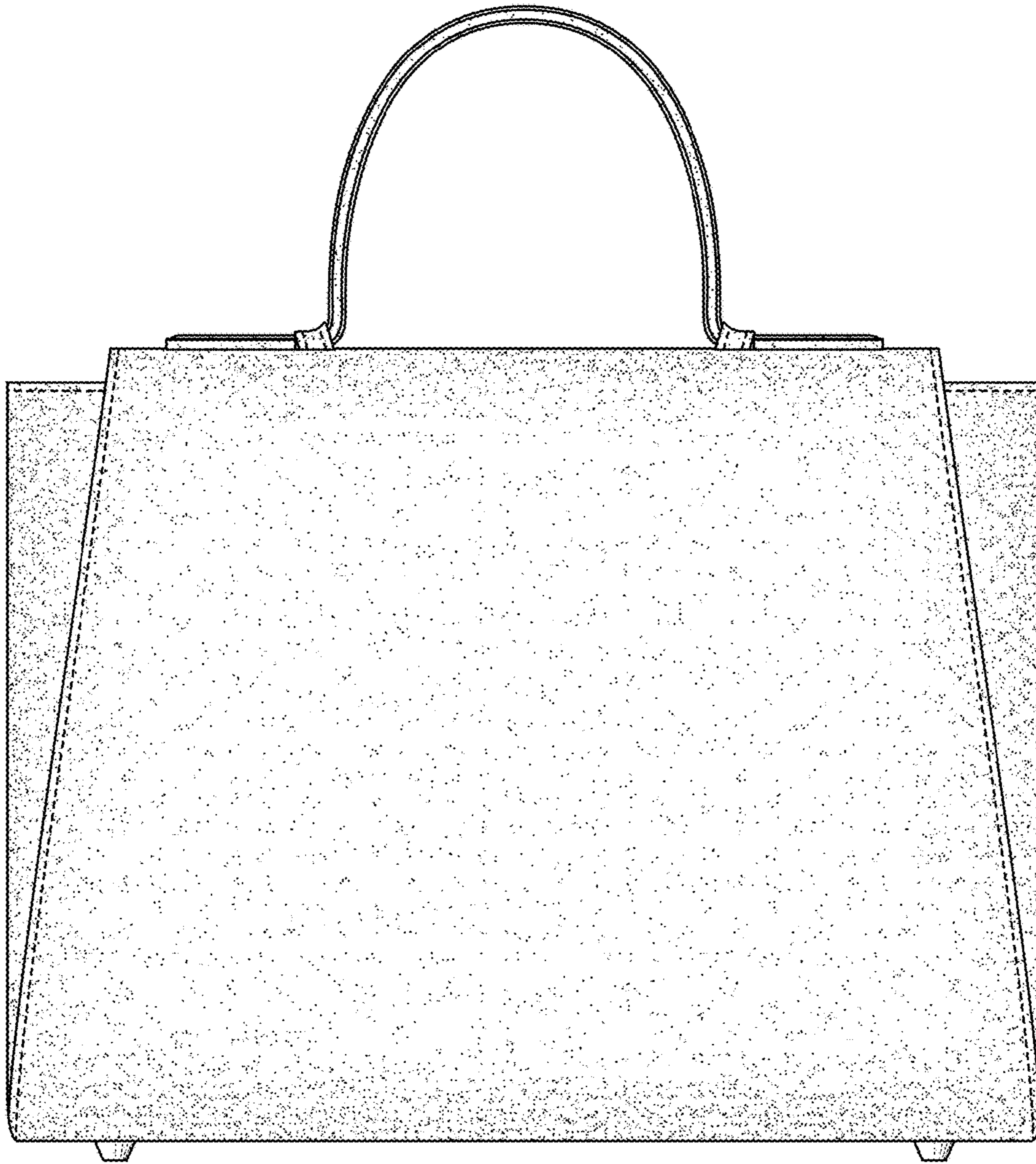

FIG. 3

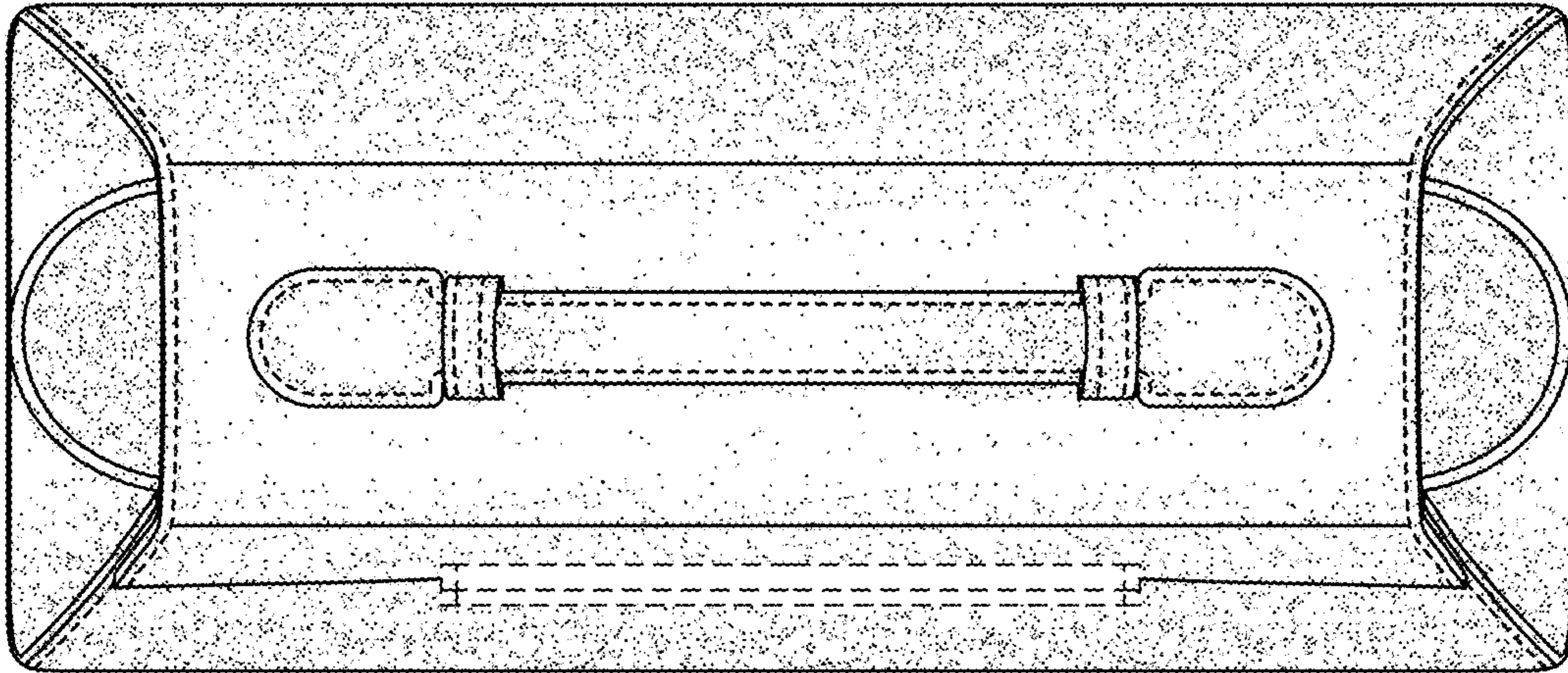

FIG. 4

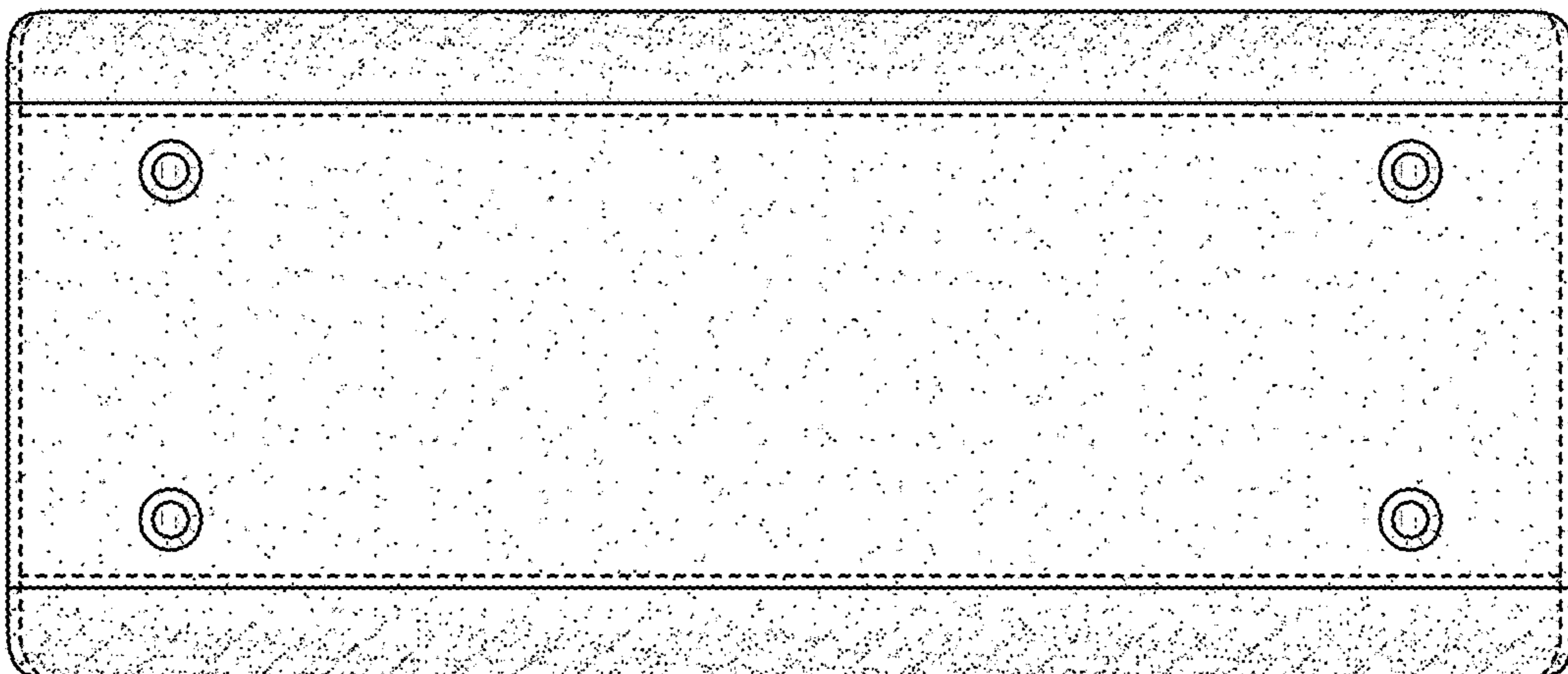

FIG. 5

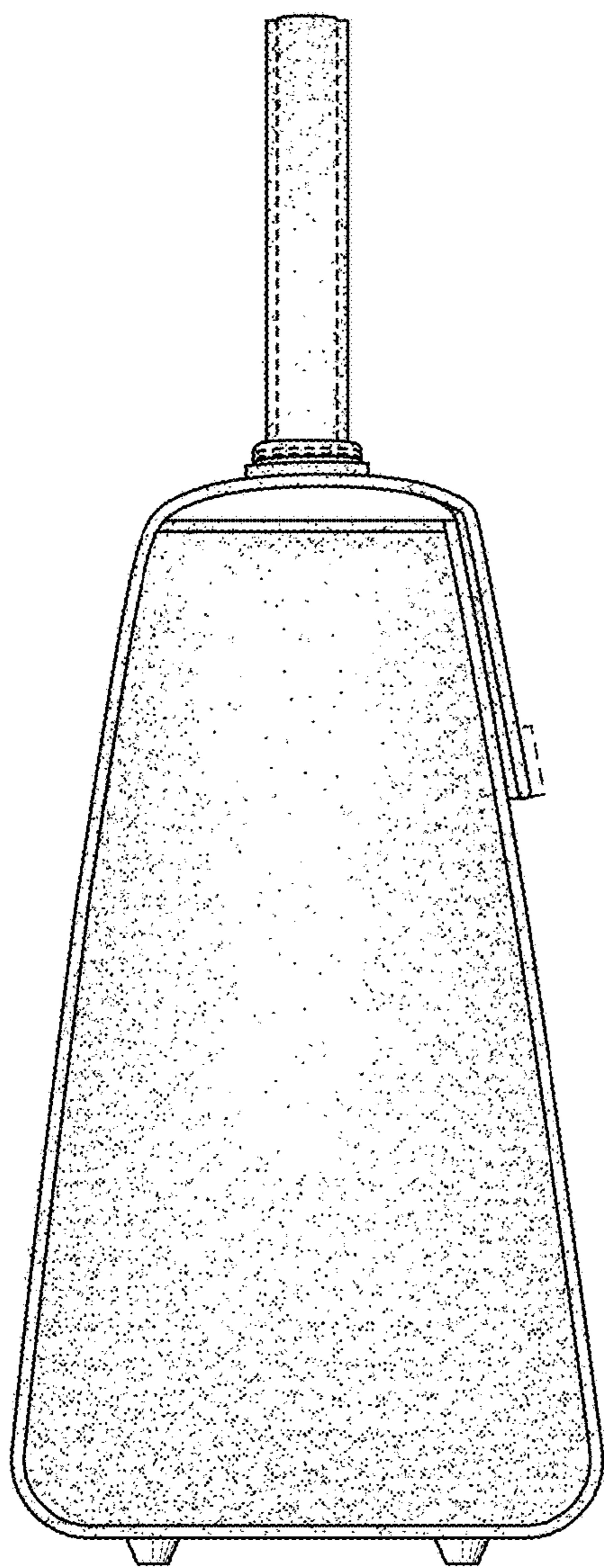

FIG. 6

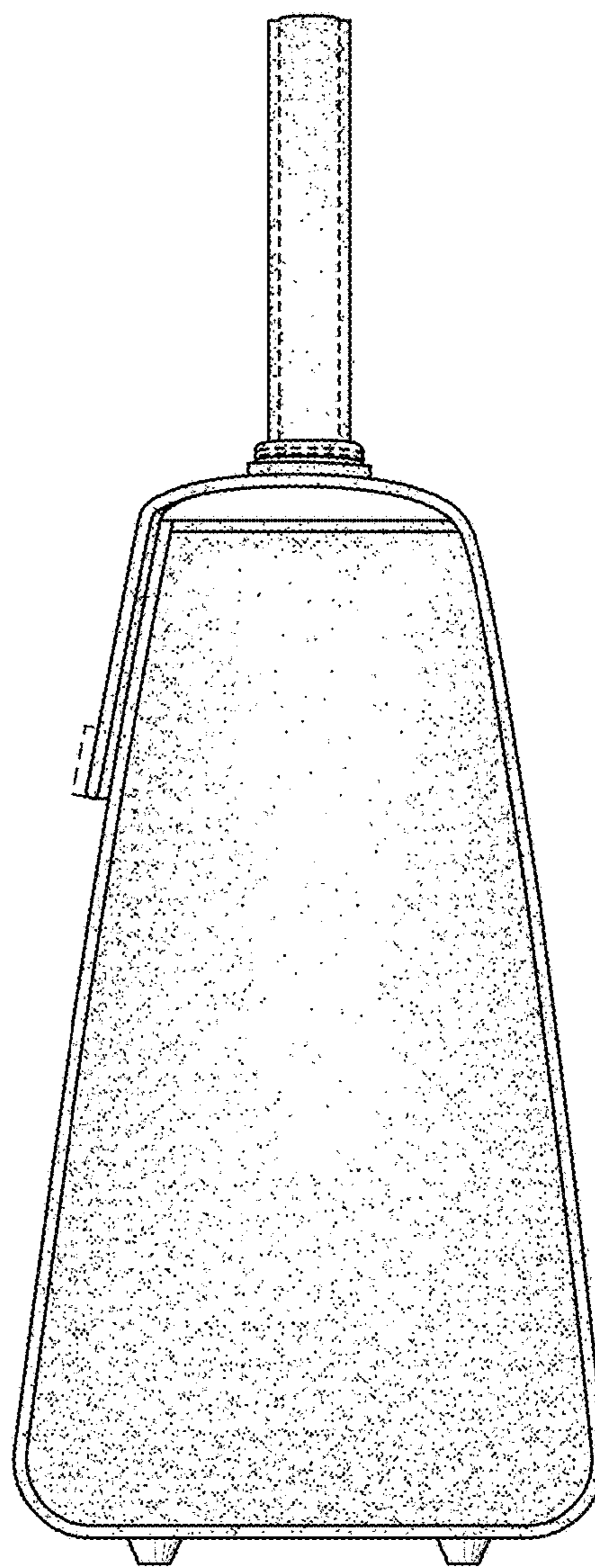

FIG. 7



FIG. 8

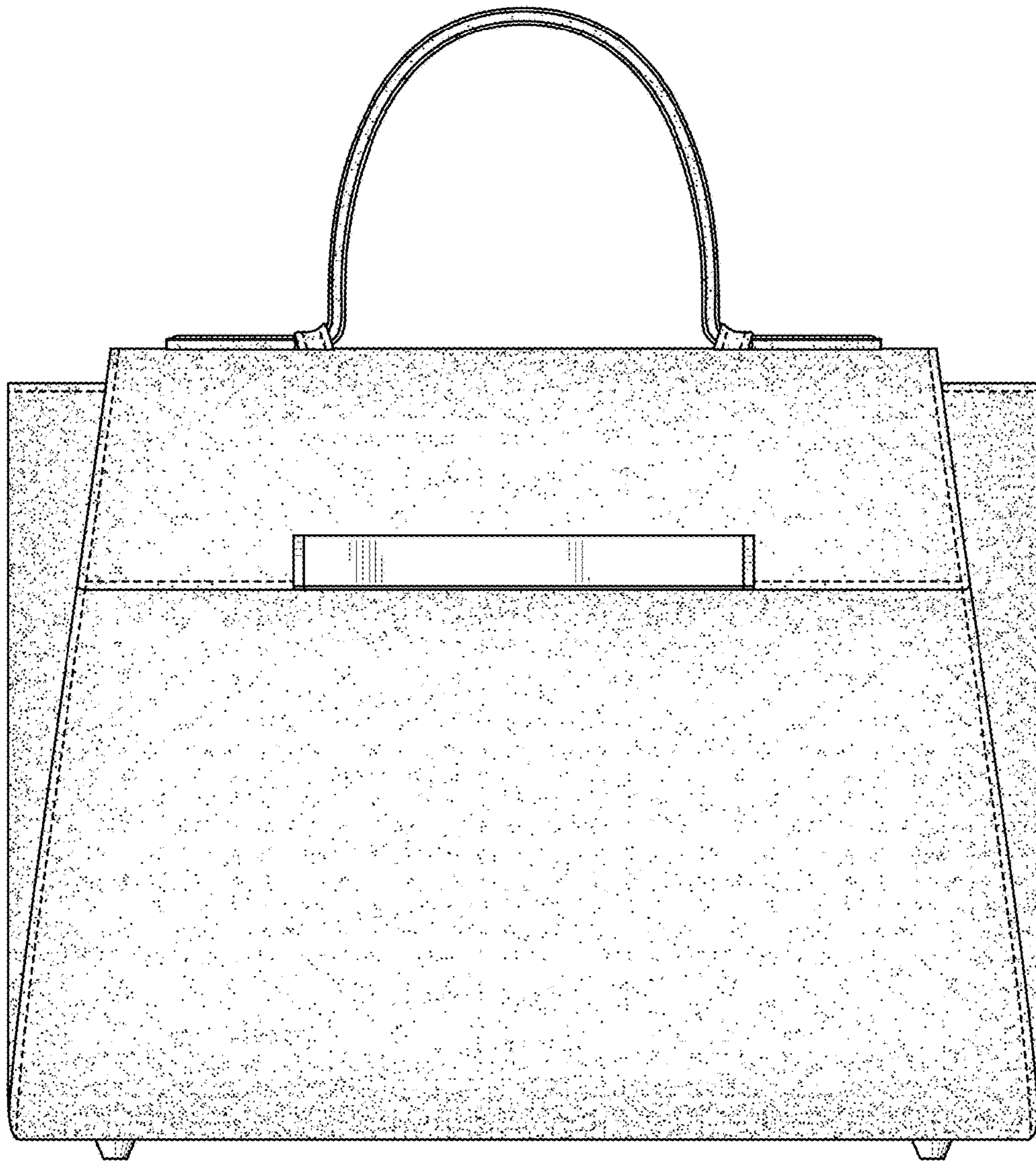

FIG. 9



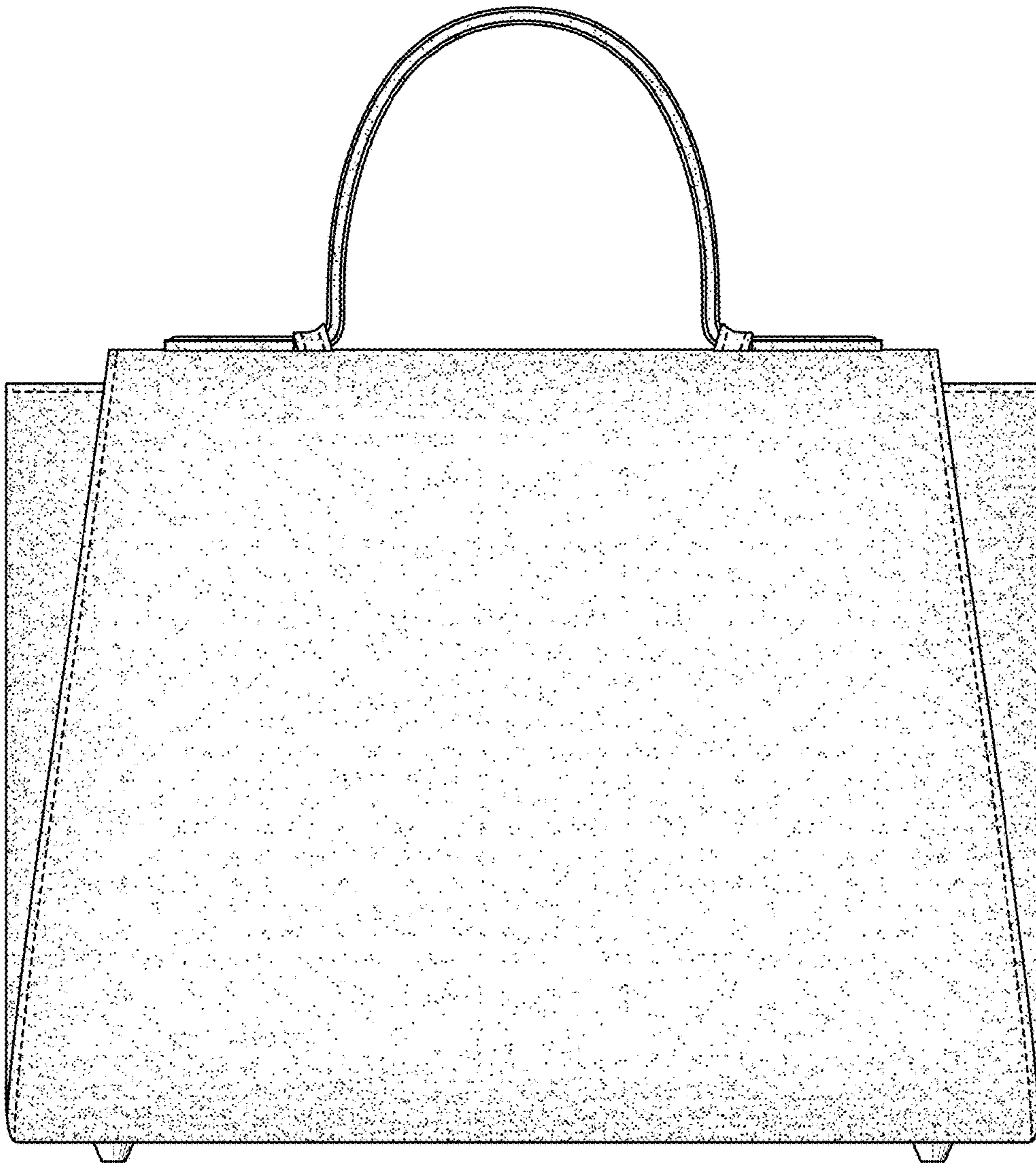

FIG. 10

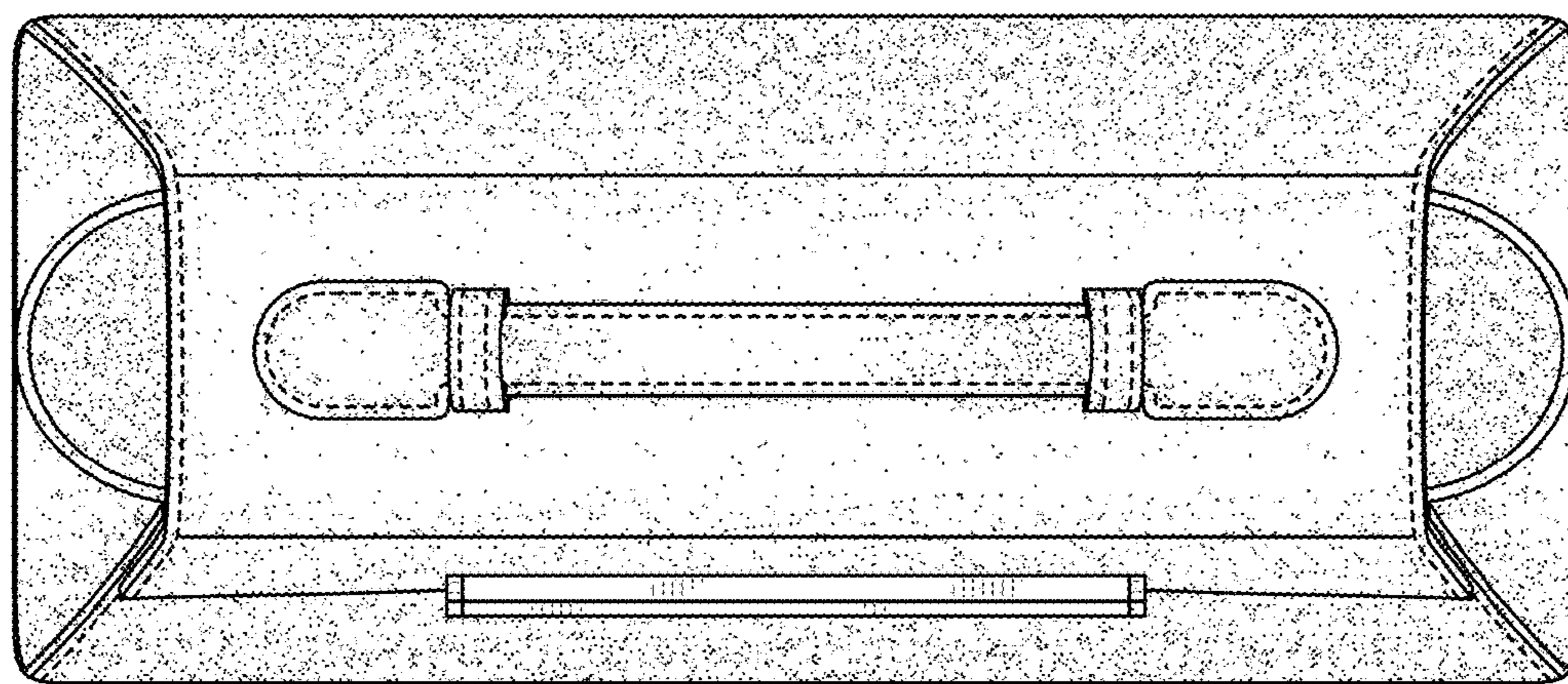

FIG. 11

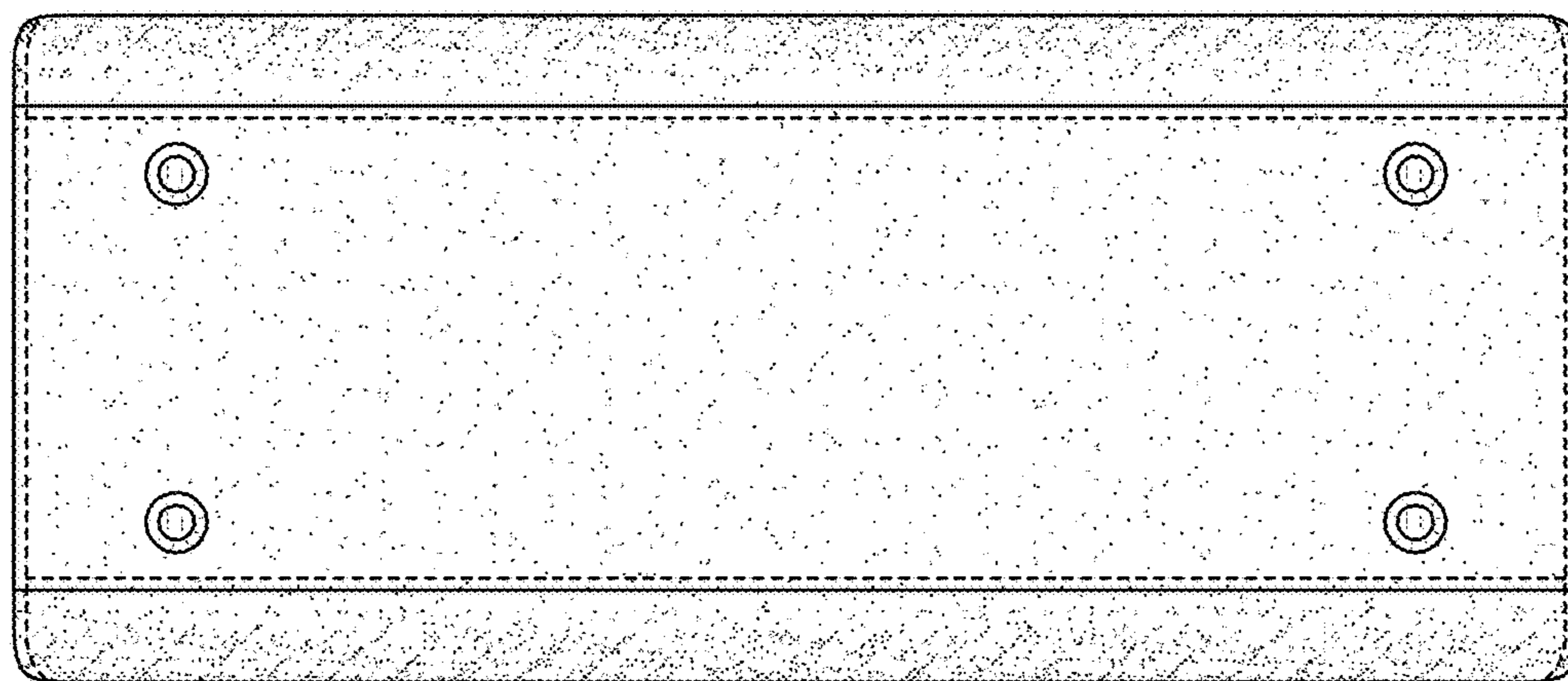

FIG. 12

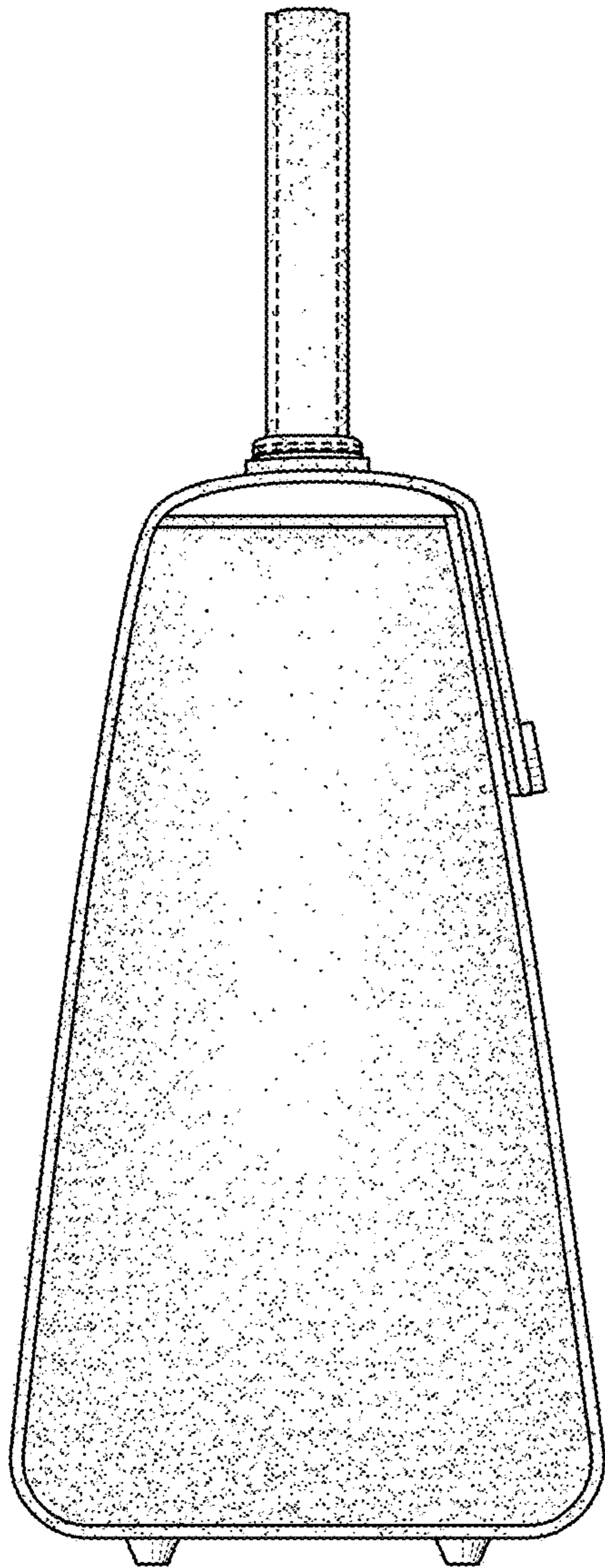

FIG. 13

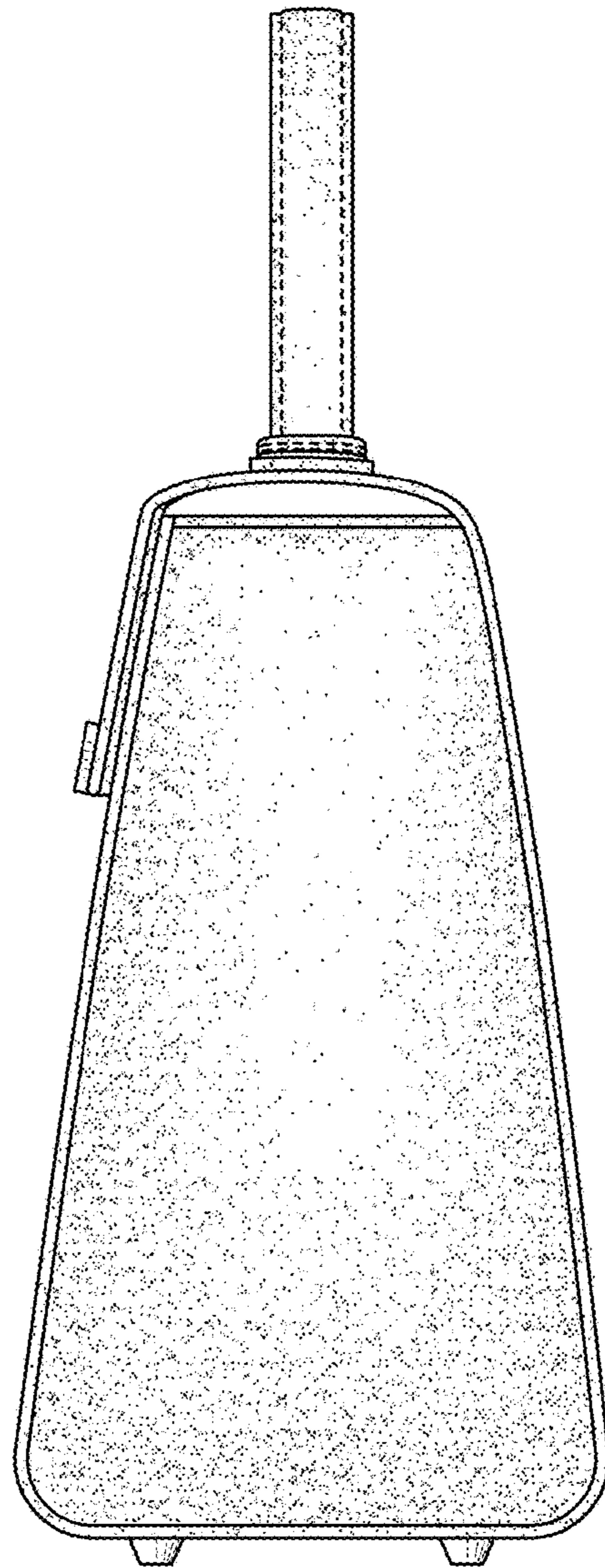

FIG. 14