



US00D855959S

(12) **United States Design Patent**
Jenkins et al.

(10) **Patent No.:** **US D855,959 S**

(45) **Date of Patent:** **** Aug. 13, 2019**

(54) **FOOTWEAR SOLE**

(71) Applicant: **TBL Licensing LLC**, Stratham, NH (US)

(72) Inventors: **Kyle M. Jenkins**, Reading, MA (US);
Pierome Sar, Stratham, NH (US);
Timothy O' Melia, Rochester, NH (US)

(73) Assignee: **TBL Licensing LLC**, Stratham, NH (US)

(**) Term: **15 Years**

(21) Appl. No.: **29/641,194**

(22) Filed: **Mar. 20, 2018**

Related U.S. Application Data

(60) Continuation-in-part of application No. 29/619,153, filed on Sep. 27, 2017, which is a division of (Continued)

(51) **LOC (12) Cl.** **02-04**

(52) **U.S. Cl.**
USPC **D2/959**; D2/947; D2/957; D2/958; D2/960

(58) **Field of Classification Search**
USPC D2/902, 906, 908, 916, 918, 925, D2/946-962, 977; 36/1, 1.5, 3 B, 22 R, (Continued)

(56) **References Cited**

U.S. PATENT DOCUMENTS

D78,191 S * 4/1929 Bush D2/959
D78,502 S * 5/1929 Blair 36/59 C
(Continued)

OTHER PUBLICATIONS

Men's Britton Hill Side-Zip Boots, Timberland.com, [online], [site visited Sep. 19, 2018]. <URL: <https://www.timberland.com/shop/>>

mens-boots/mens-britton-hill-side-zip-boots-brown-aljt9919#hero=3> (Year: 2018).*

(Continued)

Primary Examiner — T Chase Nelson
Assistant Examiner — Jonathan J. Han
(74) *Attorney, Agent, or Firm* — Lerner, David, Littenberg, Krumholz & Mentlik, LLP

(57) **CLAIM**

The ornamental design for a footwear sole, as shown and described.

DESCRIPTION

This application is related to U.S. Design patent application Ser. No. 29/641,175, U.S. Design patent application Ser. No. 29/641,181, and U.S. Design patent application Ser. No. 29/641,188 filed concurrently herewith and entitled "Footwear Sole," the entire disclosures of which, including the figures, are hereby expressly incorporated by reference herein.

FIG. 1 is a perspective view of a footwear sole in accordance with an embodiment of the ornamental design;
FIG. 2 is a front elevational view of the footwear sole in accordance with the embodiment;
FIG. 3 is a back elevational view of the footwear sole in accordance with the embodiment;
FIG. 4 is a left side elevational view of the footwear sole in accordance with the embodiment;
FIG. 5 is a right side elevational view of the footwear sole in accordance with the embodiment;
FIG. 6 is a top plan view of the footwear sole in accordance with the embodiment; and,
FIG. 7 is a bottom plan view of the footwear sole in accordance with the embodiment.

Broken lines are used to show unclaimed environment only and form no part of the claimed design.

1 Claim, 6 Drawing Sheets

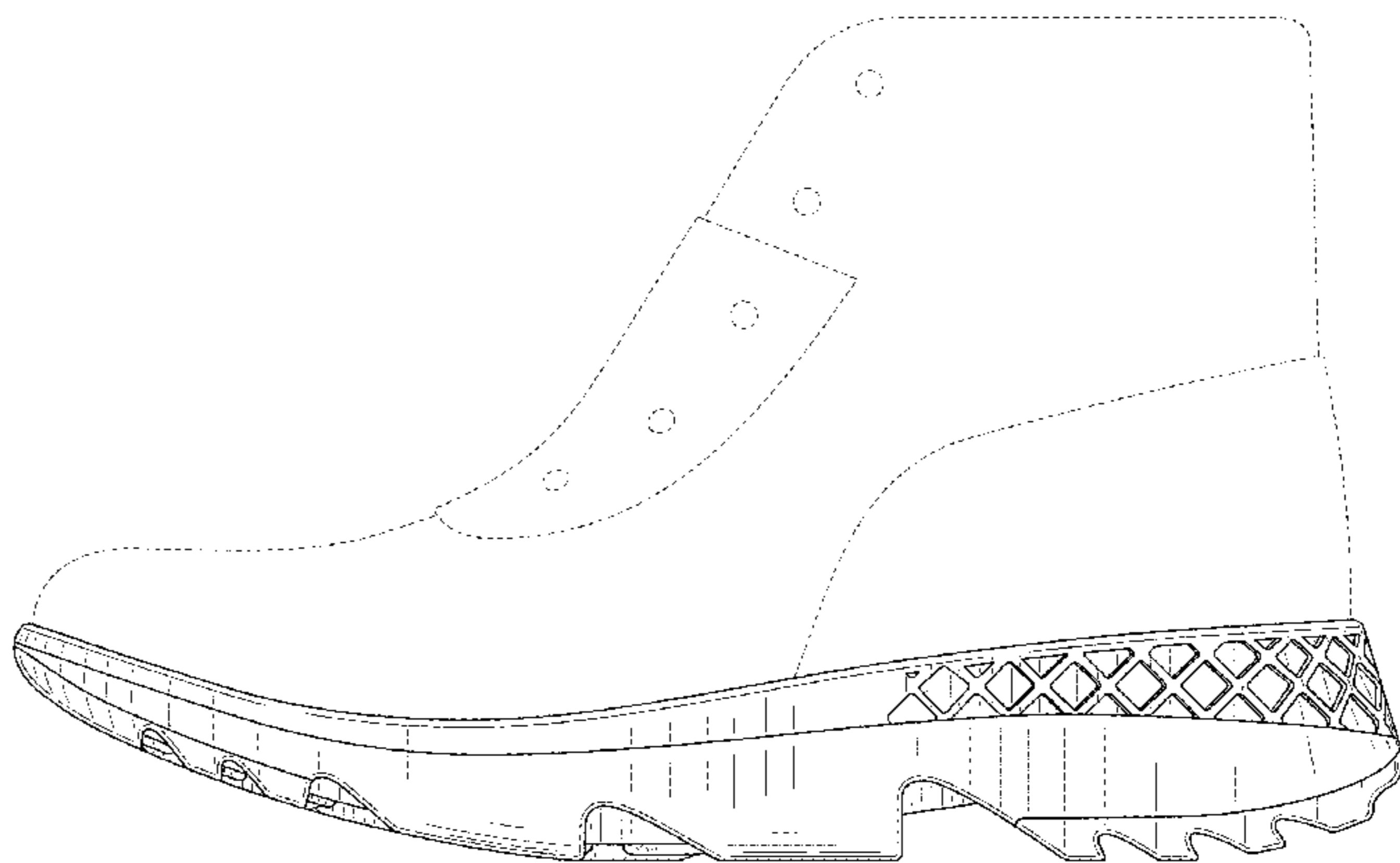
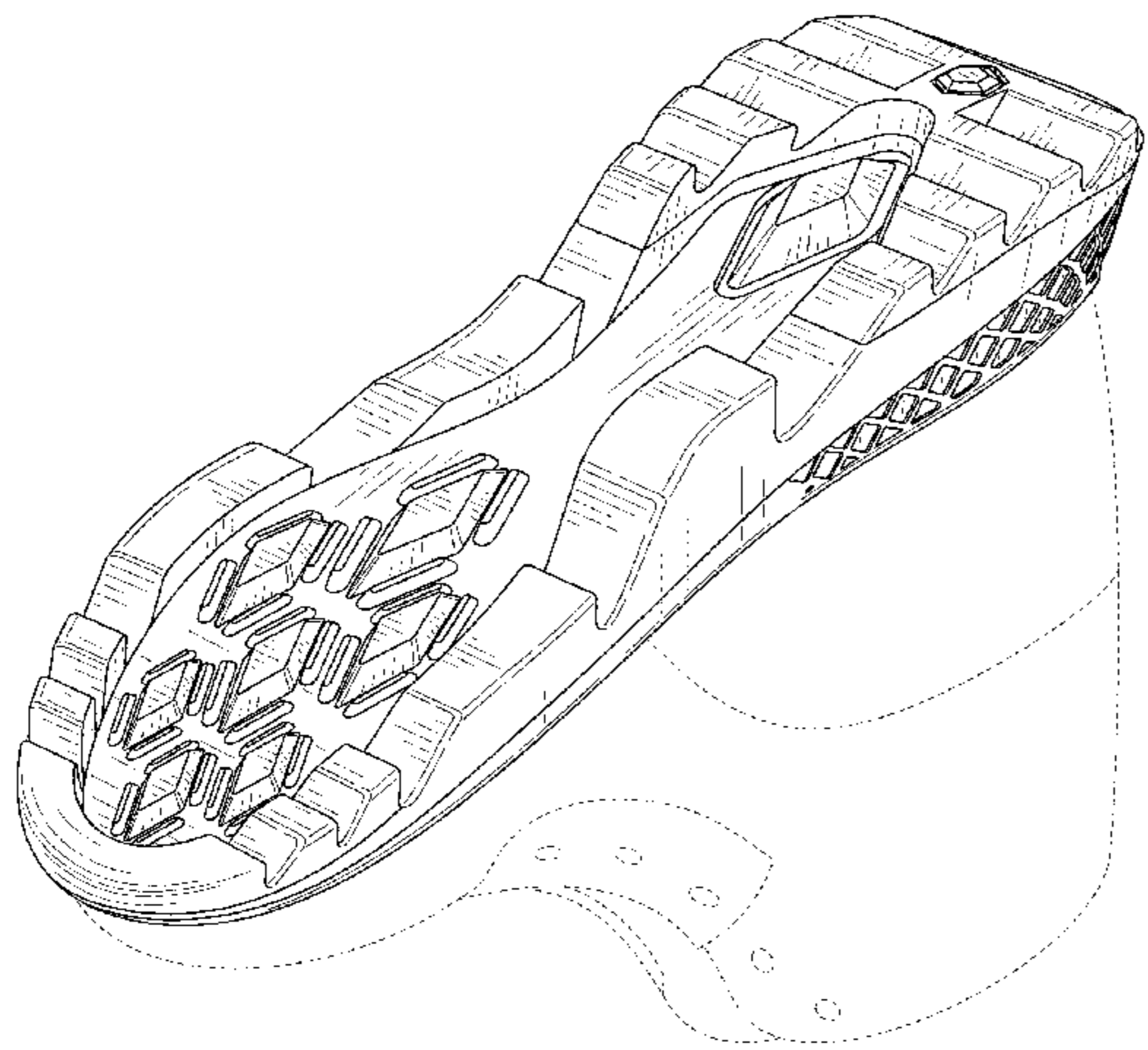

Related U.S. Application Data

application No. 29/572,482, filed on Jul. 28, 2016, now Pat. No. Des. 812,882.

(58) **Field of Classification Search**

USPC 36/24.5, 25 R, 28, 32 R, 34 R, 59 C, 36/67 A, 101–107, 114–116, 117.3, 117.4, 36/124–136; D12/544
 CPC A43B 13/00; A43B 13/02; A43B 13/023; A43B 13/026; A43B 13/04; A43B 13/08; A43B 13/10; A43B 13/12; A43B 13/14; A43B 13/141; A43B 13/143; A43B 13/16; A43B 13/18; A43B 13/181; A43B 13/187; A43B 13/189; A43B 13/20; A43B 13/22; A43B 13/223; A43B 13/24; A43B 13/28; A43B 13/30; A43B 13/32; A43B 13/34; A43B 13/36

See application file for complete search history.

(56) **References Cited**

U.S. PATENT DOCUMENTS

D98,509 S 2/1936 Goldberg
 D117,831 S 11/1939 Johnson
 D158,361 S 5/1950 Diller
 D197,505 S * 2/1964 Bingham D2/955
 D239,479 S 4/1976 Senter
 4,141,158 A 2/1979 Benseler et al.
 D259,823 S 7/1981 Greenlee
 D272,963 S 3/1984 Muller et al.
 D287,182 S 12/1986 Stubblefield
 D287,304 S 12/1986 Peterson et al.
 D296,151 S * 6/1988 Mourad D2/960
 D296,724 S 7/1988 Peterson
 D301,657 S 6/1989 Brown
 D307,817 S 5/1990 Schneider
 D323,739 S * 2/1992 Kaiser D2/959
 D329,130 S 9/1992 Yoon
 D335,572 S 5/1993 Peterson
 D337,426 S 7/1993 Dyer et al.
 D342,375 S 12/1993 Nichol, Jr.
 5,352,526 A 10/1994 Solanki et al.
 D363,371 S 10/1995 Werman
 D368,575 S 4/1996 McClain
 D389,995 S 2/1998 Cockrell
 D390,346 S 2/1998 Loveder
 D394,342 S 5/1998 Schneider
 D401,743 S 12/1998 Wunsch
 D414,022 S * 9/1999 Lozano D2/947
 D414,319 S 9/1999 Werman
 D415,609 S * 10/1999 Hlavacs D2/951
 D415,610 S 10/1999 Cahill
 D427,758 S 7/2000 Schneider
 D431,894 S * 10/2000 Begg, II D2/957
 D432,768 S 10/2000 Neely
 D433,790 S 11/2000 Oliver
 D438,697 S 3/2001 Matis et al.
 D440,748 S 4/2001 Morgan
 D441,946 S 5/2001 Agnew et al.
 D444,293 S 7/2001 Turner et al.
 D446,914 S 8/2001 Cockrell
 D446,915 S 8/2001 Cockrell
 D446,916 S 8/2001 Cockrell
 D447,326 S 9/2001 Cockrell
 D457,296 S 5/2002 Burt
 D460,608 S * 7/2002 Laberge D2/953
 D476,141 S 6/2003 Matis
 D476,142 S 6/2003 Matis
 D489,881 S 5/2004 Recchi
 D489,884 S * 5/2004 Recchi D2/951
 D496,525 S 9/2004 Dykstra
 D500,401 S * 1/2005 Matis D2/953
 D509,650 S 9/2005 Burg
 D512,827 S 12/2005 Usuki et al.

D532,585 S 11/2006 McDonald
 7,174,659 B2 2/2007 Delgorgue
 D544,699 S 6/2007 Link
 D544,700 S 6/2007 Link
 D546,053 S 7/2007 Mayden
 D549,941 S * 9/2007 Dirsa D2/953
 D562,541 S 2/2008 Avar
 D566,938 S * 4/2008 Matis D2/957
 D569,593 S 5/2008 Avar
 D578,294 S 10/2008 Mervar et al.
 D579,186 S 10/2008 Mervar et al.
 D586,994 S * 2/2009 Chang D2/951
 D588,791 S * 3/2009 Nelson D2/951
 D589,692 S 4/2009 McClaskie
 D592,847 S 5/2009 Rosenbaum
 D593,290 S 6/2009 Chen
 D594,194 S 6/2009 Butler
 D603,151 S 11/2009 Roundhouse
 D612,135 S 3/2010 Borel et al.
 D612,136 S * 3/2010 Hubner D2/951
 D613,489 S 4/2010 Horton
 D614,389 S 4/2010 Petrie
 D625,500 S * 10/2010 Dekovic D2/951
 D634,923 S * 3/2011 Lacey D2/951
 D635,754 S * 4/2011 Mariman D2/951
 7,954,259 B2 6/2011 Antonelli et al.
 D649,763 S 12/2011 Chang
 D655,902 S 3/2012 Debiase
 D656,304 S 3/2012 Debiase
 8,151,488 B2 4/2012 Aveni
 D662,296 S 6/2012 Christopherson
 D662,695 S 7/2012 McVicker et al.
 D672,543 S 12/2012 Williams, Jr.
 D675,418 S 2/2013 Van Zyll De Jong et al.
 D677,451 S 3/2013 Amphyon
 D677,453 S * 3/2013 Sakai D2/951
 D687,220 S 8/2013 Aveni
 D702,422 S 4/2014 Dougherty
 D712,128 S 9/2014 Zaedow
 D721,474 S 1/2015 Miner
 D722,220 S 2/2015 Miner
 D722,425 S 2/2015 Cin
 D724,830 S 3/2015 Joseph
 D725,357 S 3/2015 Miner
 D735,454 S 8/2015 Yun
 D737,038 S 8/2015 Dolce
 D740,012 S 10/2015 O'Connor
 D742,196 S 11/2015 Dow et al.
 D744,728 S 12/2015 Remmele
 D746,561 S 1/2016 Bikowski
 D755,490 S * 5/2016 Nakano D2/951
 D765,383 S 9/2016 Chang
 D767,861 S 10/2016 Wattimena
 D770,749 S 11/2016 Paz et al.
 D770,752 S 11/2016 McMillan
 D772,554 S 11/2016 McMillan et al.
 D773,790 S 12/2016 Raysse
 D773,791 S 12/2016 Raysse
 D773,795 S 12/2016 Lok
 D779,174 S 2/2017 de Montgolfier
 D781,543 S 3/2017 Raysse
 D782,799 S 4/2017 Caron et al.
 D783,247 S 4/2017 McMillan
 D784,666 S 4/2017 Lok
 D785,305 S * 5/2017 Adam D2/951
 D792,067 S 7/2017 Raysse
 D794,929 S * 8/2017 Petrie D2/951
 D796,170 S 9/2017 Raysse
 D796,814 S 9/2017 Hatfield
 D796,823 S 9/2017 Schenone
 D797,418 S 9/2017 Lee et al.
 D797,423 S * 9/2017 Bischoff D2/951
 D802,276 S * 11/2017 de Montgolfier D2/959
 D802,899 S * 11/2017 Bischoff D2/957
 D803,534 S * 11/2017 Strother D2/957
 D805,749 S 12/2017 Mokos et al.
 D811,064 S * 2/2018 Gibson D2/957
 D812,882 S * 3/2018 Jenkins D2/959
 2006/0059715 A1 3/2006 Aveni

(56)

References Cited

U.S. PATENT DOCUMENTS

2007/0130801	A1 *	6/2007	Wu	A43B 13/26 36/59 R
2012/0180341	A1	7/2012	Crowley, II et al.	
2013/0019505	A1	1/2013	Borel et al.	
2013/0145653	A1	6/2013	Bradford	
2015/0089842	A1	4/2015	Zamer-Juarez	
2016/0302523	A1 *	10/2016	Fujita	A43B 13/122
2016/0324260	A1	11/2016	Guyan	
2016/0360828	A1	12/2016	Guyan	
2016/0374428	A1	12/2016	Kormann et al.	
2017/0071283	A1	3/2017	James	

OTHER PUBLICATIONS

Men's Cross Mark Utility Boots, Timberland.com, [online], [site visited Sep. 19, 2018]. <URL: <https://www.timberland.com/shop/mens-boots/mens-cross-mark-utility-boots-wheat-a1tt4231#hero=3>> (Year: 2018).*

Men's City's Edge Waterproof Boots, Timberland.com, [online], [site visited Sep. 19, 2018]. <URL: <https://www.timberland.com/shop/mens-boots/mens-citys-edge-waterproof-boots-black-a1slz001#hero=2>> (Year: 2018).*

Men's 1978 Flyroam Waterproof Hiking Boots, Timberland.com, [online], [site visited Sep. 19, 2018]. <URL: <https://www.timberland.com/shop/mens-boots/mens-1978-aerocore-waterproof-hiking-boots-brown-a1rma201#hero=3>> (Year: 2018).*

Men's Cityforce Raider Sneaker Boots, Timberland.com, [online], [site visited Sep. 19, 2018]. <URL: <https://www.timberland.com/shop/mens-boots/mens-cityforce-raider-boots-blue-a1ux3019#hero=3>> (Year: 2018).*

SportShoes.com Brochure "Spring, no fun standing still", EVERUN Continuous Cushioning Saucony, printed Jul. 27, 2016, p. 3 and p. 24.

Amazon.com, "Clarks Men's Lace-Up Trainers Shoes Seremax Avion", downloaded Sep. 2, 2016, pp. 1-3.

Amazon.com, "Clarks Men's Lace-Up Trainers Shoes Seremax Avion", Various views of shoes, downloaded Sep. 2, 2016, pp. 1-7.

Amazon.com, "Clarks Men's Seremax Lace Lace Up Sneaker", downloaded Sep. 2, 2016, p. 1-3.

Amazon.com, "Clarks Men's Seremax Lace Lace Up Sneaker", Various images, downloaded Sep. 2, 2016, pp. 1-7.

Men's Flyroam Sport Chukka Shoes, Timberland.com, [online], [site visited Apr. 28, 2017], <URL: <https://www.timberland.com/shop/mens-footwear/mens-fly-roam-sport-chukka-shoes-wheat-a1hrp260>>, 1 page.

Men's Flyroam Oxford Shoes, Timberland.com, [online], [site visited Apr. 28, 2017]. <URL: <https://www.timberland.com/shop/mens-footwear/mens-fly-roam-oxford-shoes-grey-a1kxm100>>, 1 page.

Timberland's Fresh New Flyroam Is the Dynamic Sneakerboot You Need This Spring, Highsnobiety.com, By Jack Drummond, Feb. 17, 2017, [online], [site visited Apr. 28, 2017]. <URL: <http://www.highsnobiety.com/2017/02/17/timberland-flyroamsneakerboot!>>, 2 pages.

Timberland's Flyroam Collection Is Made for Urban Seekers, Hypebeast.com, Feb. 2, 2017, [online], [site visited Apr. 28, 2017], <URL: <https://hypebeast.com/2017/2/timberland-flyroam-collection-353>>, 2 pages.

Adidas Previews the Future of 3D Printed Sneakers, SoleCollector.com, By Brian Dunne, Oct. 7, 2015, [online], [site visited Apr. 28, 2017], <URL: <https://solecollector.com/news/2015/10/adidas-futurecraft-3d-printed-running-sneakers>>, 6 pages.

Nike Air Huarache, Nike.com, [online], [site visited Apr. 28, 2017], <URL: http://store.nike.com/us/en_us/pd/air-huarache-mensshoe/pid-11380351/pgid-10978234>, 2 pages.

Taiwanese Search Report (English translation only) for Application No. 105307033, dated May 5, 2017.

Did Timberland Flyroam Stealing Adidas Boost?, YouTube.com, CjCityTv, Published on Aug. 22, 2017, [online], [site visited Mar. 5, 2018]. <URL: https://www.youtube.com/watch?v=Y221eE_17qY> (Year: 2017).

Men's Flyroam Leather Hiker Boots, Timberland.com, [online], [site visited Mar. 5, 2018]. <URL: <https://www.timberland.com/shop/mens-flyroam-leather-hiker-boots-black-a1ovb001#hero=0>> (Year: 2018).

Pureboost Shoes, Adidas.com, [online], [site visited Mar. 5, 2018]. <URL: <https://www.adidas.com/us/pureboost-shoes/BB6288.html>> (Year: 2018).

Timberland Unveils a Complete Look at Its 2017 Flyroam Collection, HypeBeast.com, Feb. 17, 2017, [online], [site visited Mar. 5, 2018]. <URL: <https://hypebeast.com/2017/2/timberland-flyroam-collection-lookbook>> (Year: 2017).

* cited by examiner

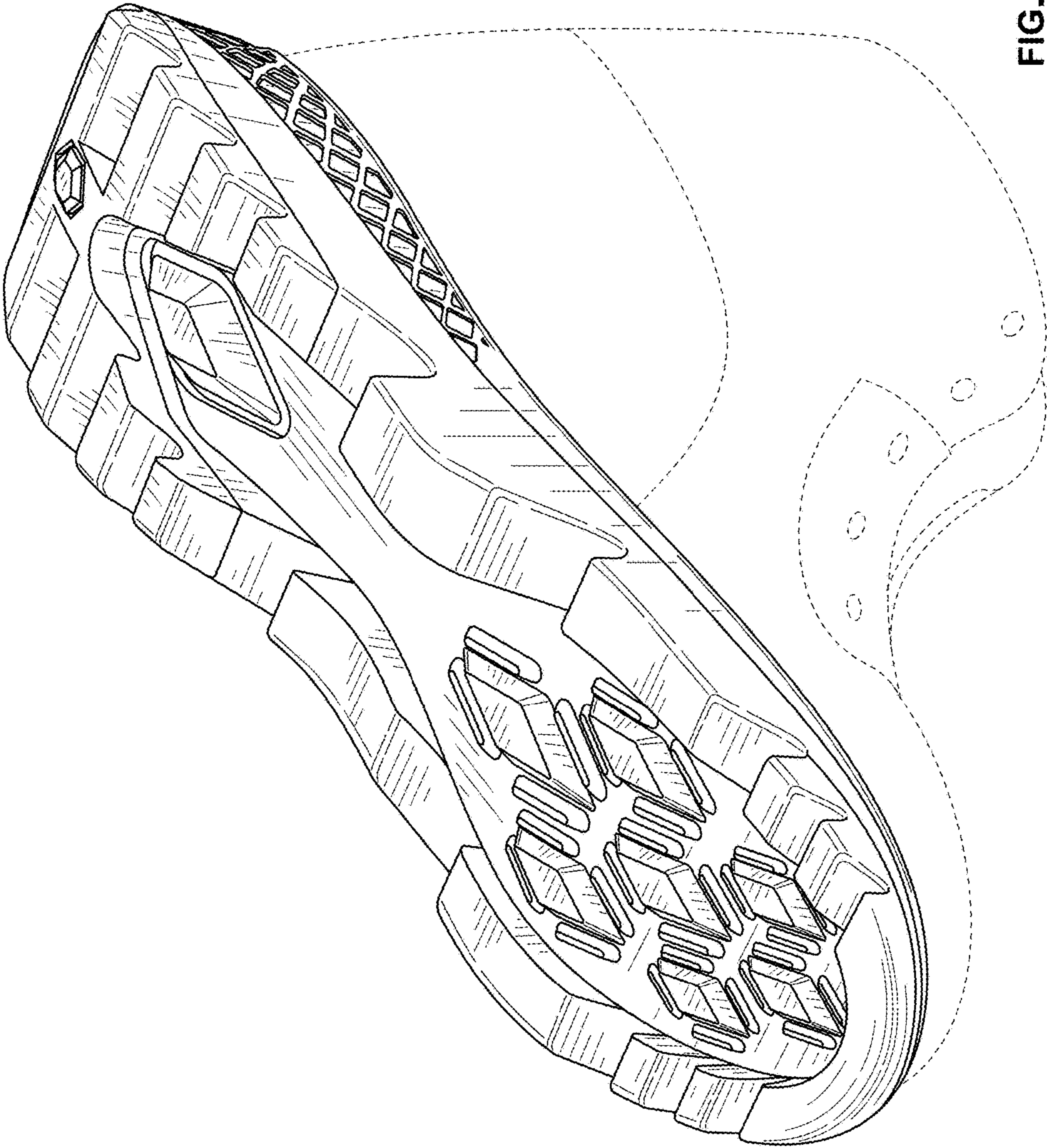

FIG. 1

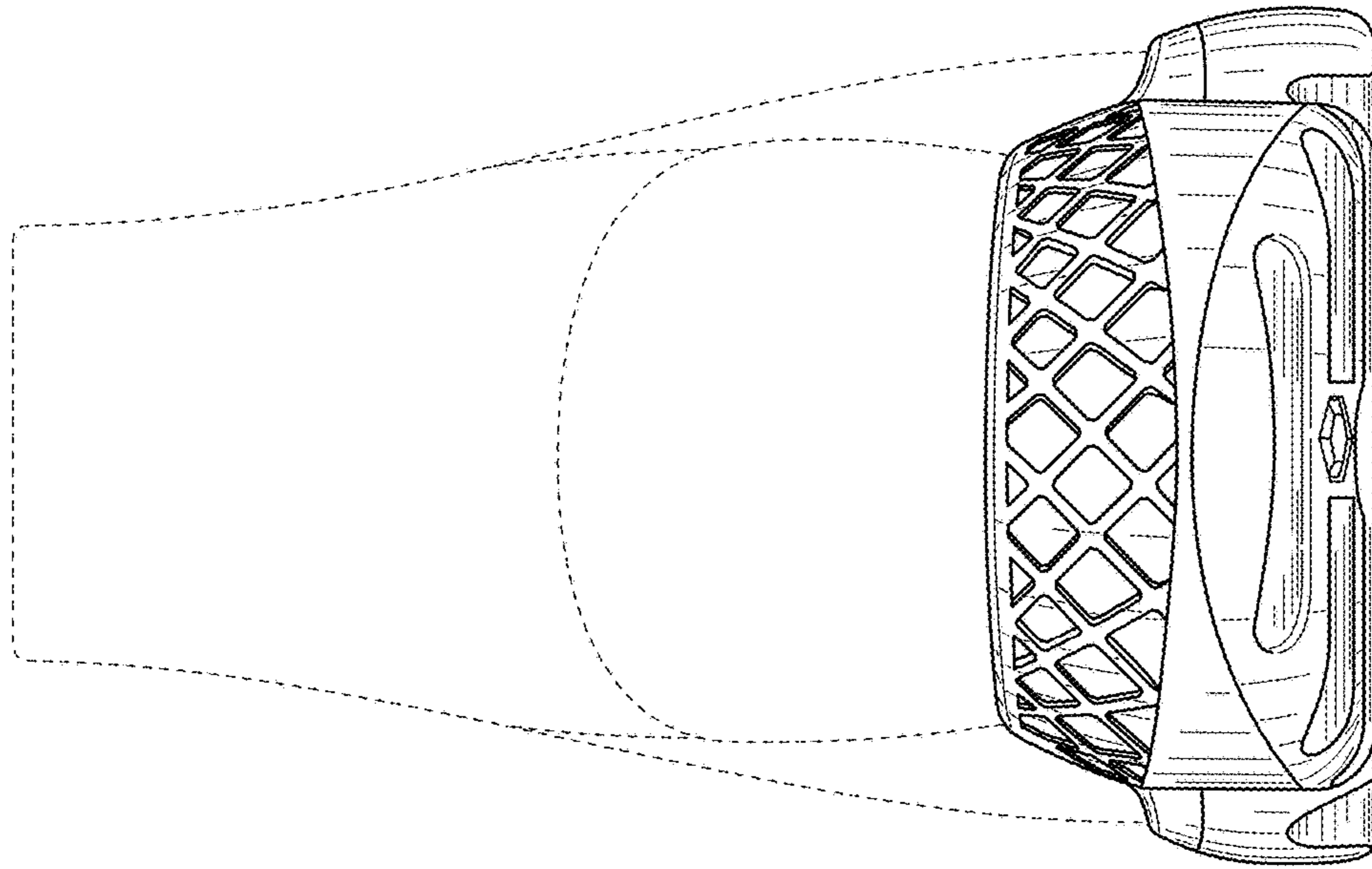

FIG. 3

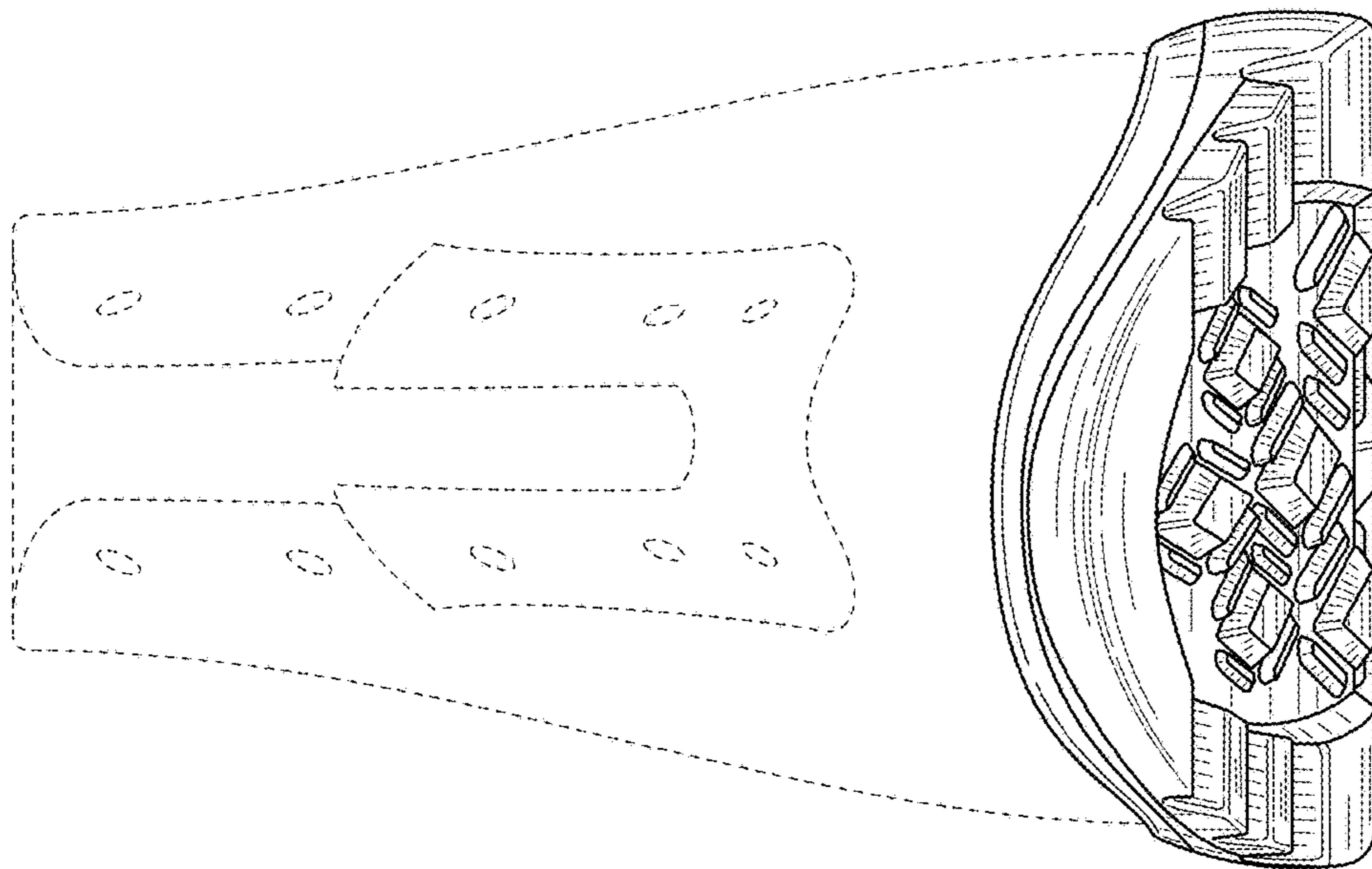

FIG. 2

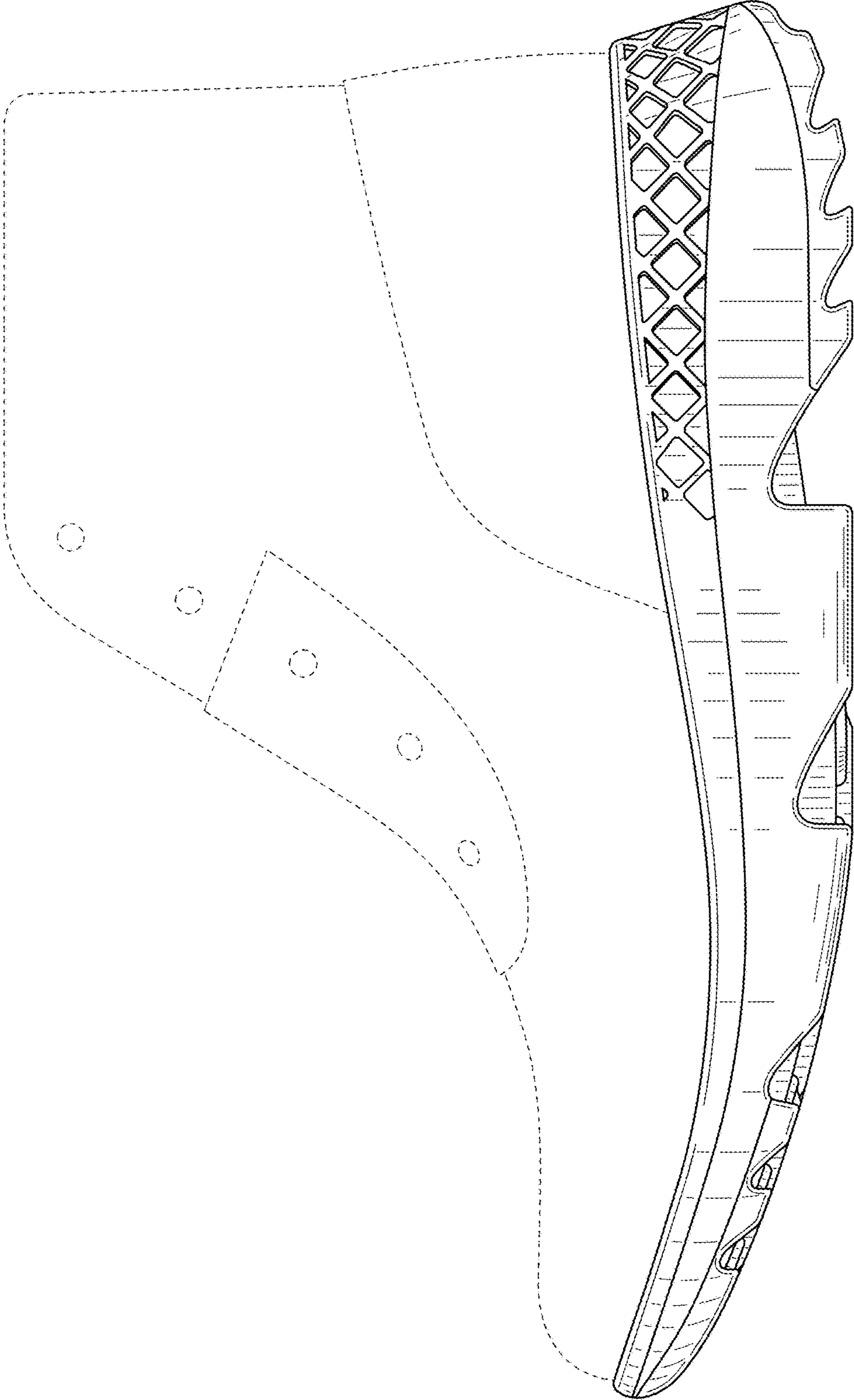

FIG. 4

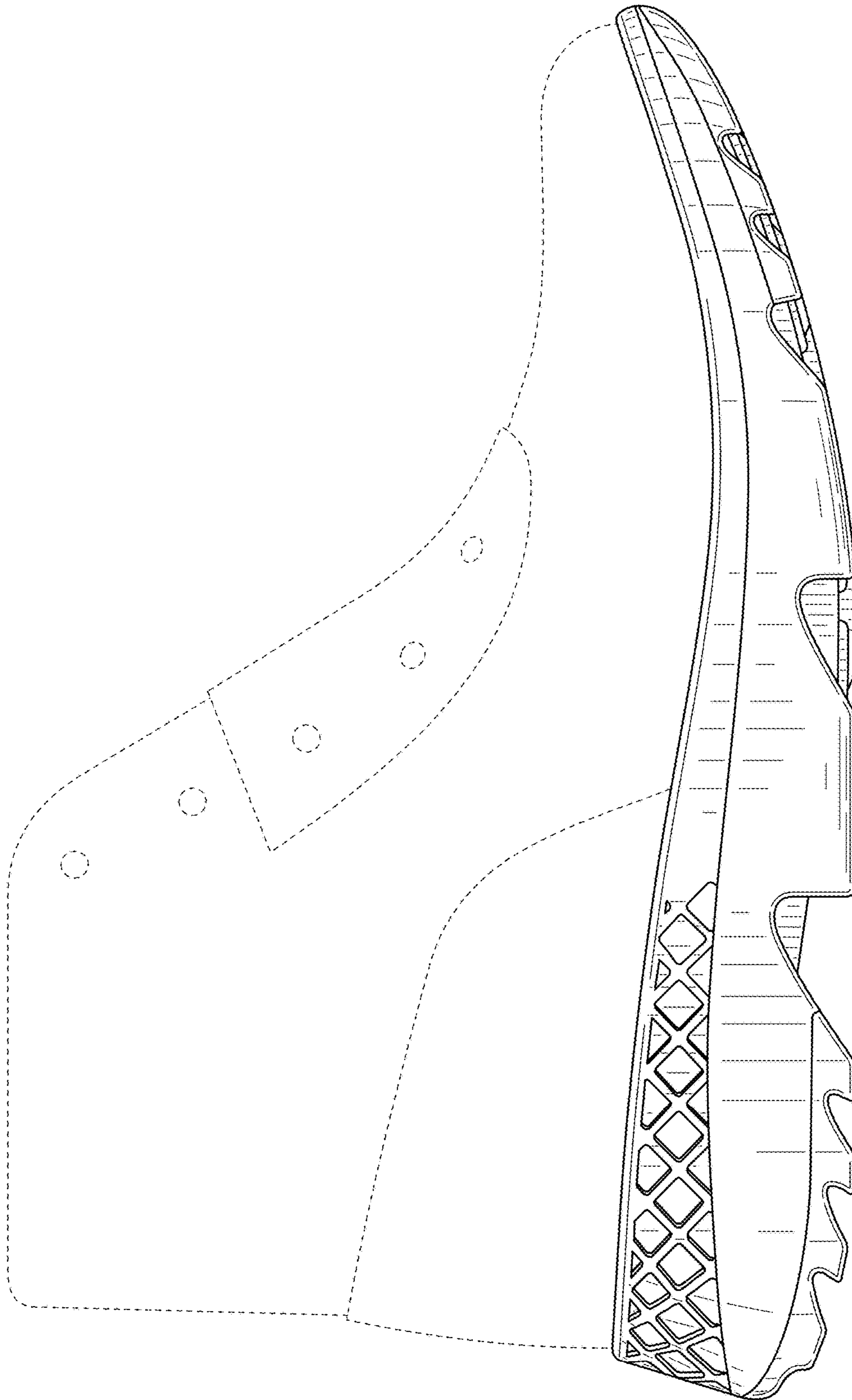

FIG. 5

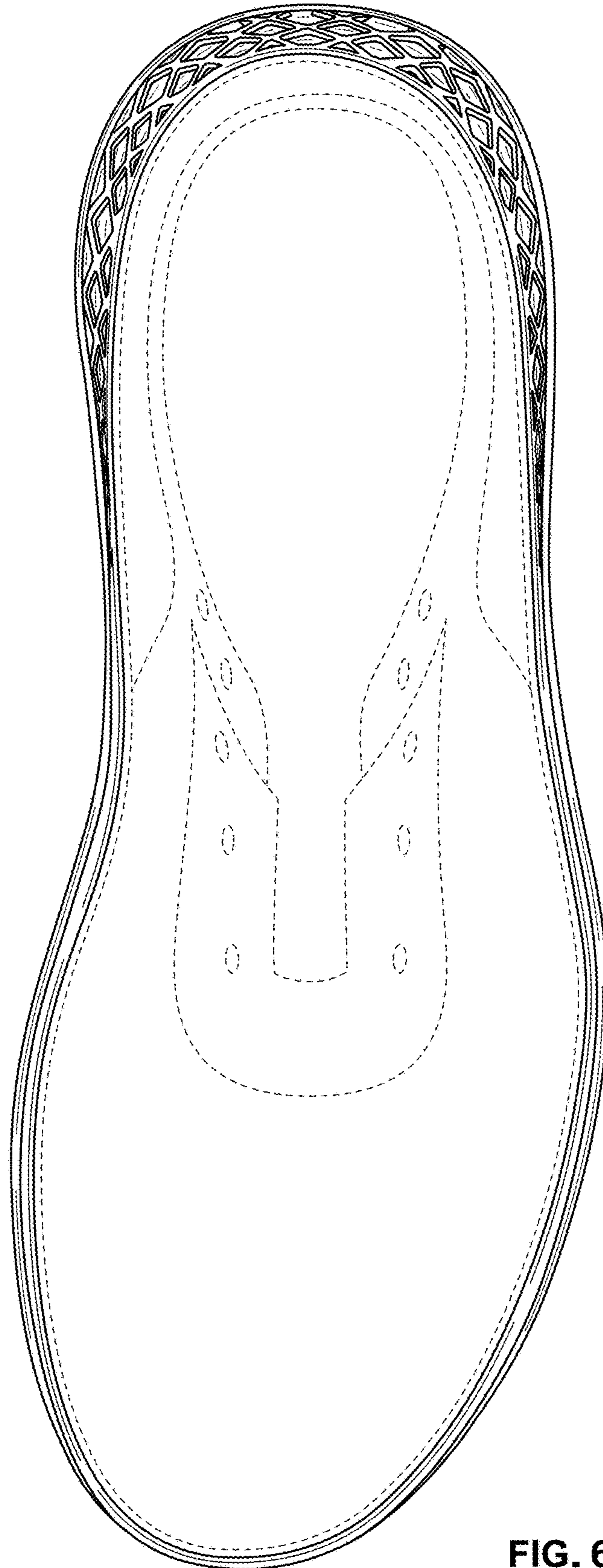

FIG. 6

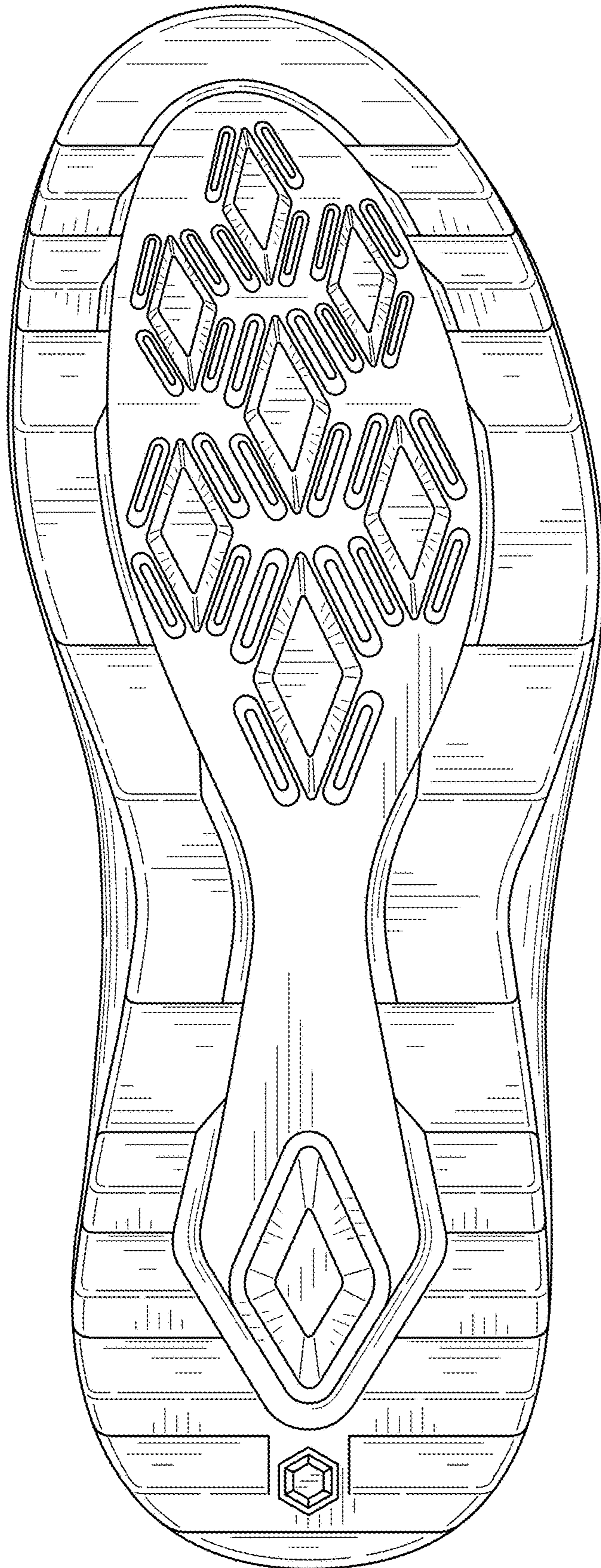

FIG. 7