



US00D855932S

(12) **United States Design Patent**
Kirkham

(10) **Patent No.:** **US D855,932 S**

(45) **Date of Patent:** **** Aug. 13, 2019**

(54) **HOT DOG BUN**

(71) Applicant: **Kody Kirkham**, Payson, UT (US)

(72) Inventor: **Kody Kirkham**, Payson, UT (US)

(**) Term: **15 Years**

(21) Appl. No.: **29/633,921**

(22) Filed: **Jan. 17, 2018**

(51) **LOC (12) Cl.** **01-01**

(52) **U.S. Cl.**

USPC **D1/129**; D1/122

(58) **Field of Classification Search**

USPC D1/100-130, 199; 426/92, 94, 95, 99,
426/101, 138, 139, 143, 275, 132, 279,
426/282-283, 391, 514; D9/544, 682,
D9/694, 414, 702; 249/92; D23/267;
D7/504, 509, 510, 523, 524, 555, 566,
D7/568, 584-587, 602, 672, 300.1, 601;
D21/386; D25/119, 121; D12/223, 162;
D8/356; D19/91

CPC A23G 9/48; A21D 2/16; A21D 13/0029;
A23L 1/217; A22C 13/0013

See application file for complete search history.

(56) **References Cited**

U.S. PATENT DOCUMENTS

| | | | | | |
|-----------|-----|---------|------------|-------|------------|
| 1,600,191 | A * | 9/1926 | Mandelbaum | | A21D 13/32 |
| | | | | | 346/33 A |
| 2,012,815 | A * | 8/1935 | Hodges | | A21C 11/12 |
| | | | | | 249/117 |
| 2,810,338 | A * | 10/1957 | Dawson | | A21B 3/132 |
| | | | | | 249/122 |
| 3,341,167 | A * | 9/1967 | Weiss | | A47J 43/20 |
| | | | | | 249/119 |
| 4,047,477 | A * | 9/1977 | Berke | | A21B 3/13 |
| | | | | | 249/92 |

| | | | | | |
|--------------|------|---------|---------------|-------|--------------|
| D248,061 | S | 6/1978 | Bangert | | |
| D256,385 | S * | 8/1980 | Fields | | D11/11 |
| 4,725,444 | A | 2/1988 | Wilkins | | |
| 4,846,519 | A * | 7/1989 | Leonard | | A45F 5/1046 |
| | | | | | 294/171 |
| 5,722,117 | A * | 3/1998 | Nielsen | | A45F 5/1046 |
| | | | | | 16/411 |
| 5,897,900 | A | 4/1999 | Groulx et al. | | |
| D429,454 | S * | 8/2000 | Lademann, III | | D8/303 |
| 6,293,311 | B1 * | 9/2001 | Bushi | | B29C 47/0023 |
| | | | | | 138/138 |
| D450,420 | S | 11/2001 | Brost et al. | | |
| D451,364 | S * | 12/2001 | Borotto | | D8/323 |
| D487,326 | S * | 3/2004 | Stoddart | | D1/101 |
| 9,089,240 | B2 | 7/2015 | Mayemick | | |
| D755,468 | S | 5/2016 | Elliot | | |
| D758,673 | S * | 6/2016 | Farris | | D30/129 |
| 2007/0235627 | A1 | 10/2007 | Leach et al. | | |
| 2012/0201927 | A1 | 8/2012 | Meikle | | |
| 2014/0272004 | A1 | 9/2014 | Porat | | |
| 2016/0066587 | A1 | 3/2016 | Trinh et al. | | |

* cited by examiner

Primary Examiner — Katie Jane Stofko

(57) **CLAIM**

The ornamental design for a hot dog bun, as shown and described.

DESCRIPTION

FIG. 1 is a front view of a hot dog bun showing my new design, a rear view being identical;
FIG. 2 is a left side view of the hot dog bun, a right side view being identical;
FIG. 3 is a top view of the hot dog bun;
FIG. 4 is a bottom view of the hot dog bun; and,
FIG. 5 is a top front side perspective view of the hot dog bun. The broken lines in FIG. 5 illustrate environment that forms no part of the claimed design.

1 Claim, 5 Drawing Sheets

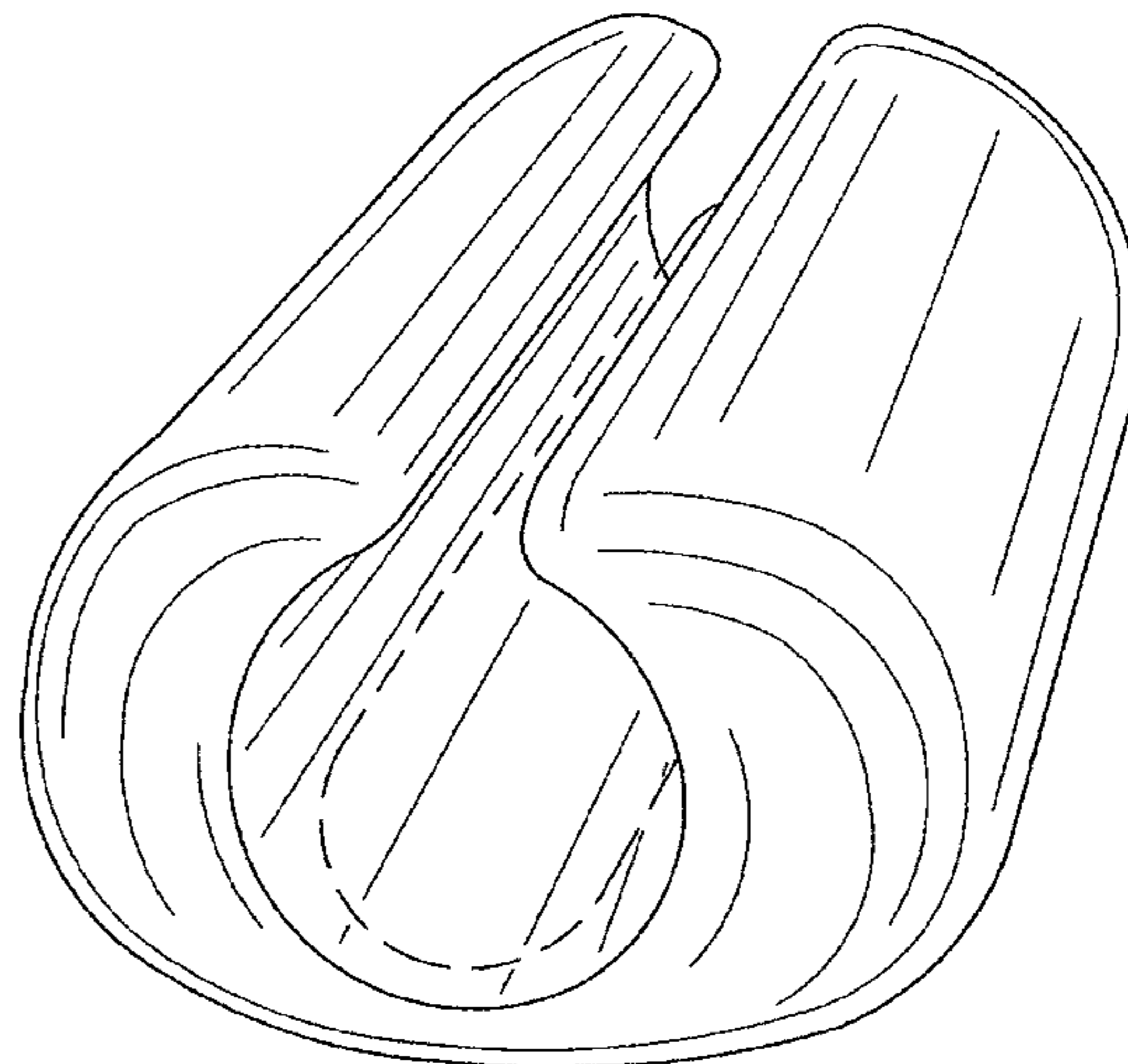
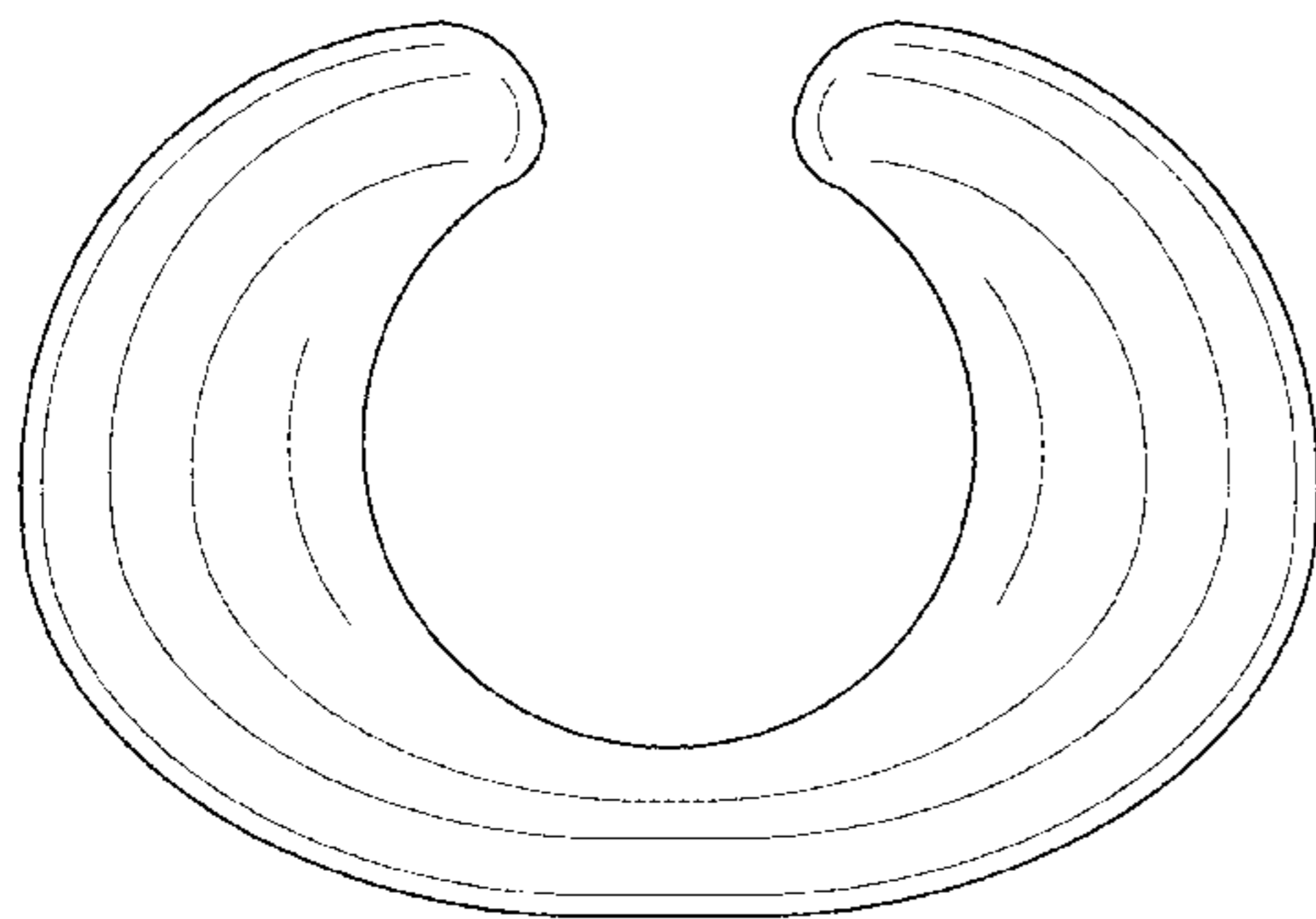

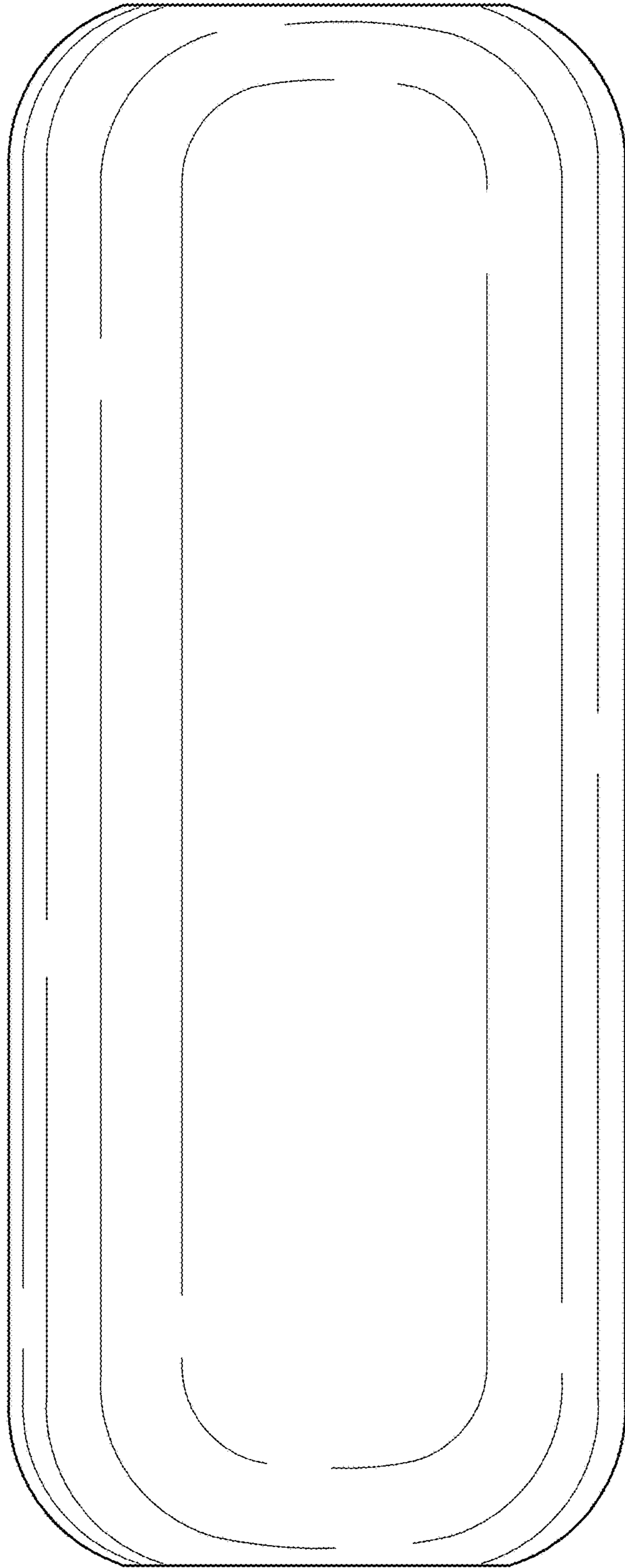

FIG. 1

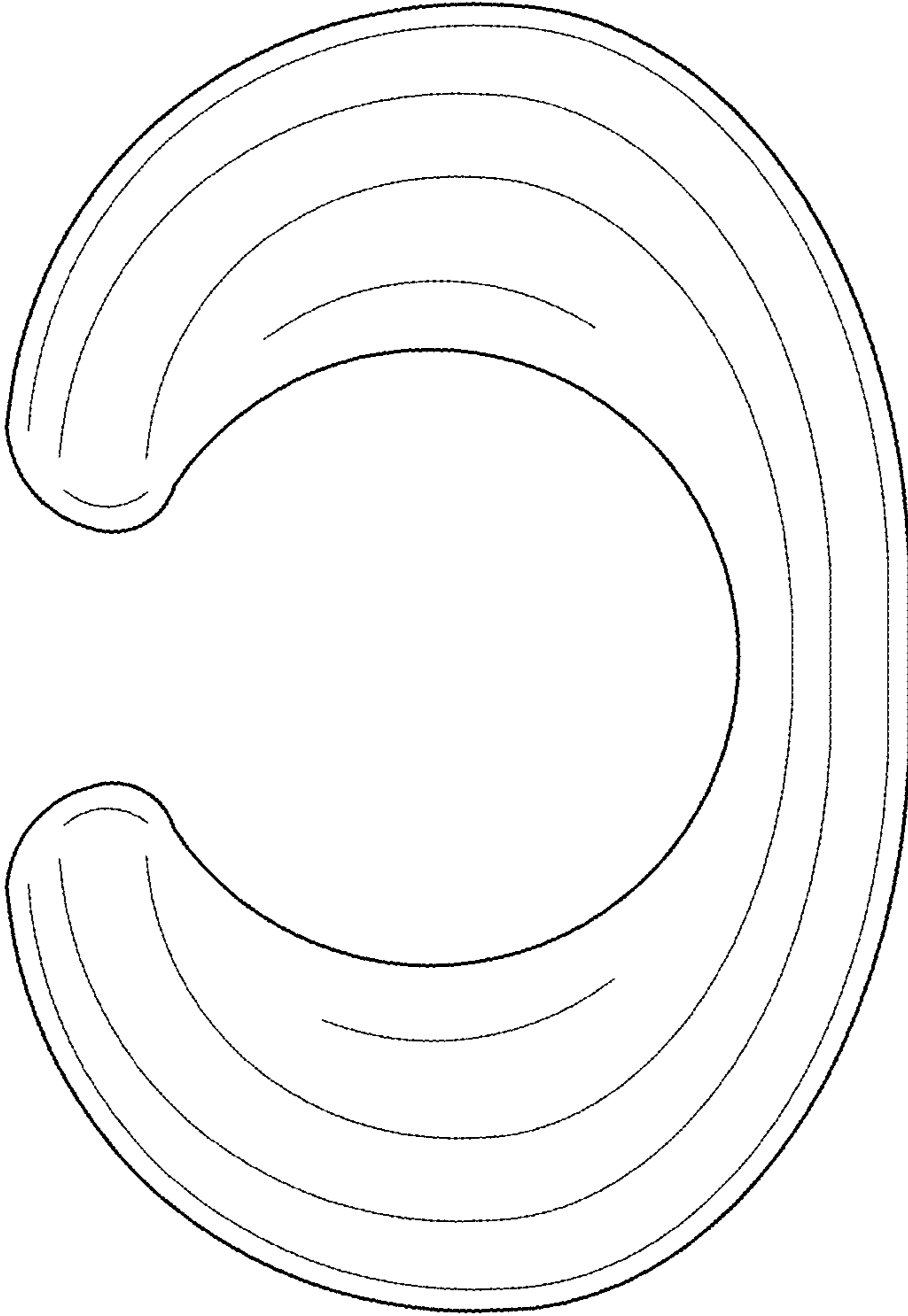

FIG. 2

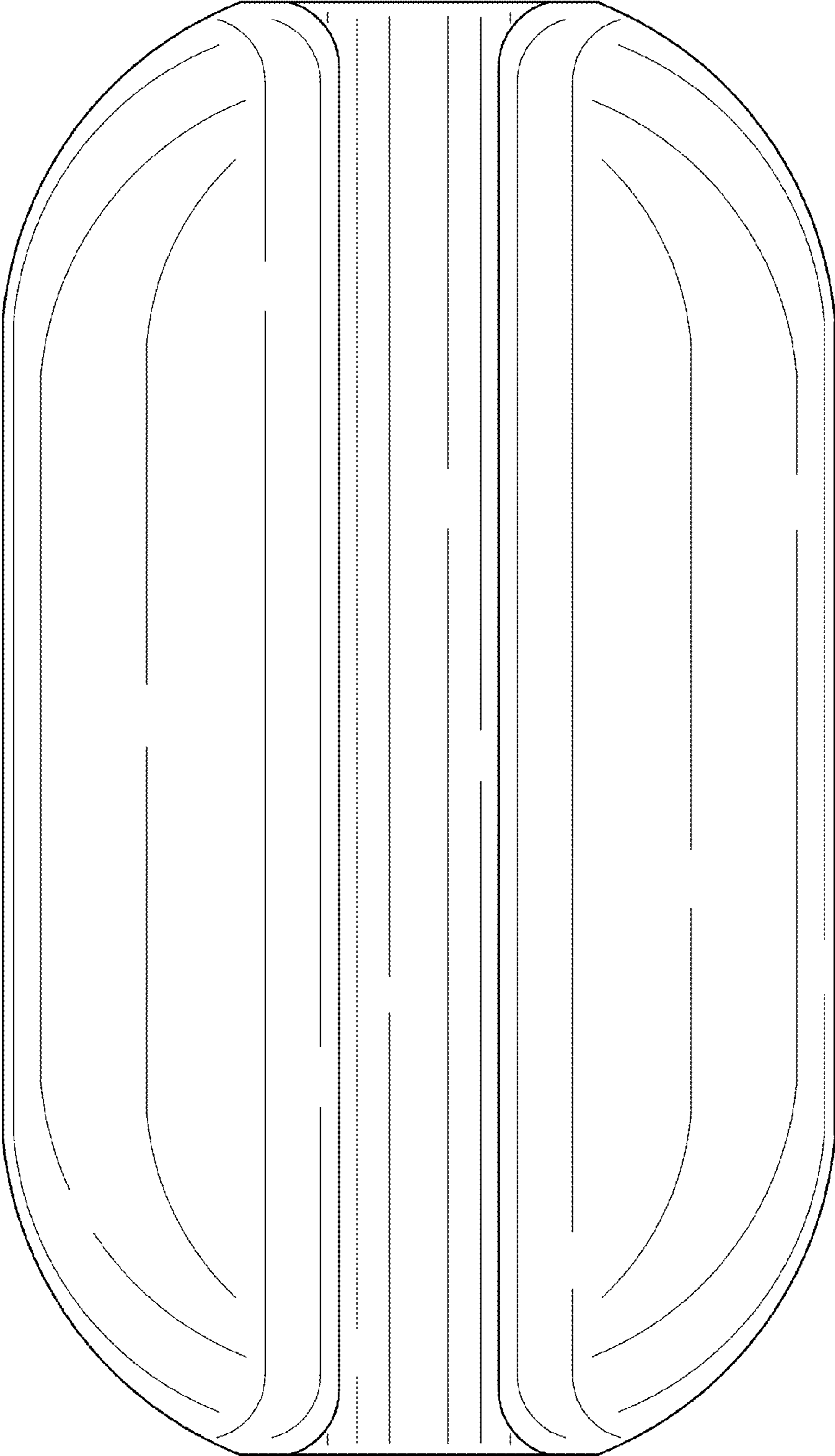

FIG. 3

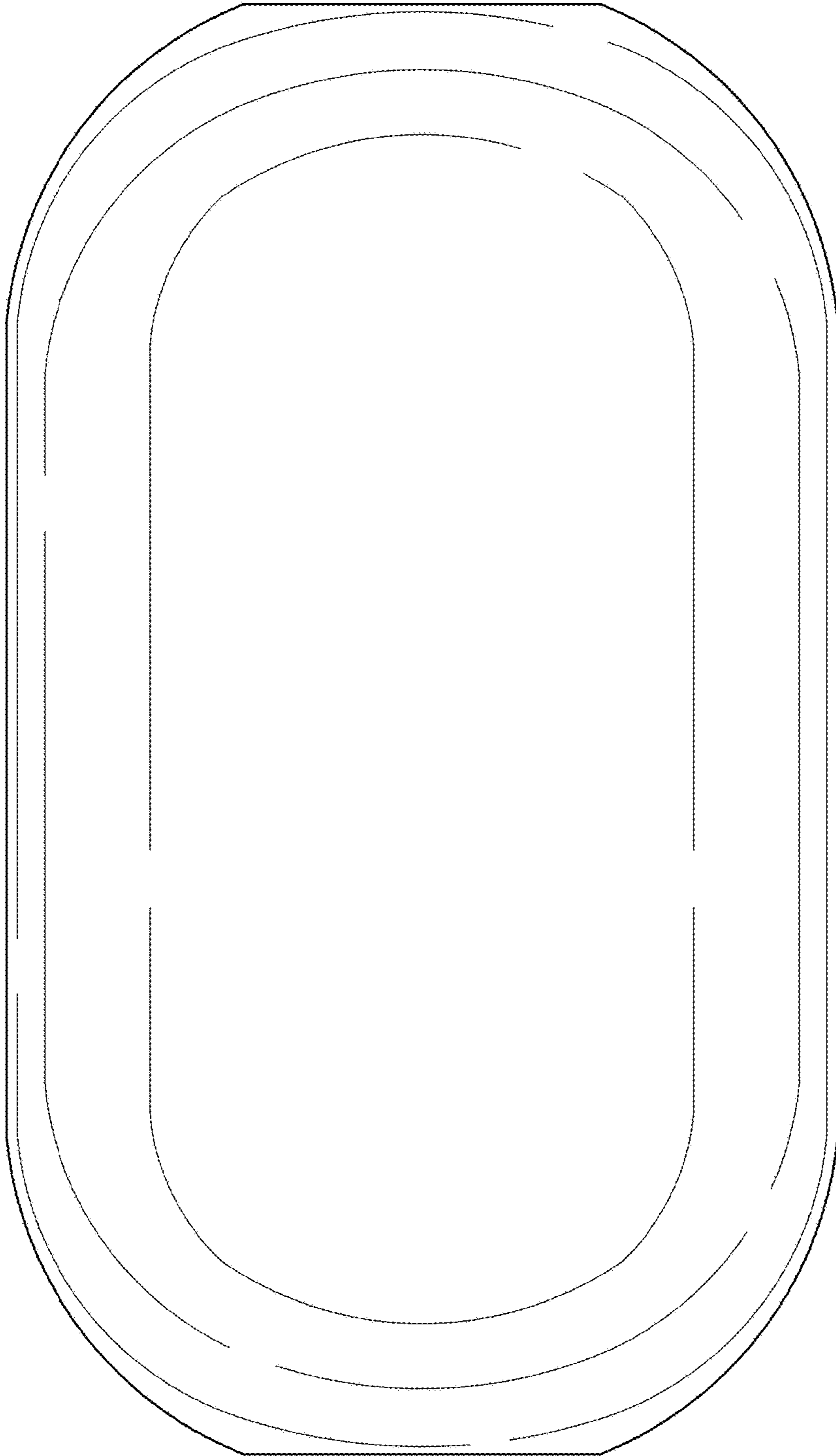

FIG. 4

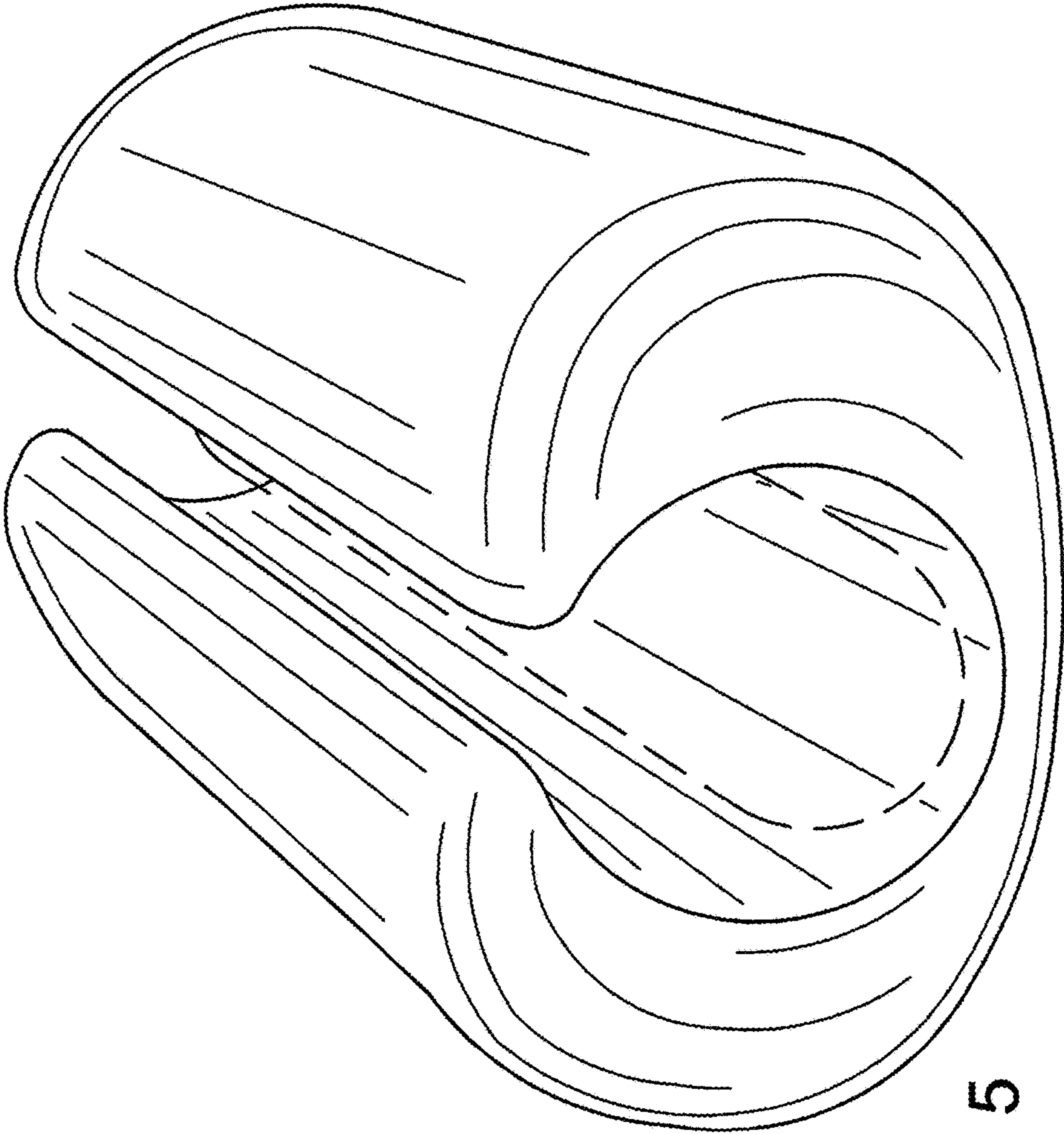

FIG. 5