



US00D855869S

(12) **United States Design Patent**
Sonneman

(10) **Patent No.:** **US D855,869 S**

(45) **Date of Patent:** **** Aug. 6, 2019**

(54) **LIGHT FIXTURE**

(71) Applicant: **Contemporary Visions, LLC,**
Larchmont, NY (US)

(72) Inventor: **Robert A. Sonneman,** Mamaroneck,
NY (US)

(73) Assignee: **Contemporary Visions, LLC,**
Larchmont, NY (US)

(**) Term: **15 Years**

(21) Appl. No.: **29/674,251**

(22) Filed: **Dec. 20, 2018**

(51) **LOC (12) Cl.** **26-03**

(52) **U.S. Cl.**
USPC **D26/87; D26/86**

(58) **Field of Classification Search**
USPC D26/72, 80-92, 118
CPC F21S 8/03; F21S 8/033; F21S 8/036; F21S
8/037; F21S 8/038; F21S 8/04; F21S
8/043; F21S 8/046; F21S 8/06; F21S
8/061; F21S 8/063; F21S 8/065; F21S
8/068

See application file for complete search history.

(56) **References Cited**

U.S. PATENT DOCUMENTS

D43,646 S *	2/1913	Ryan	D26/88
D78,477 S *	5/1929	McFadden	D26/85
D79,375 S *	9/1929	Lazerson	D26/88
D79,655 S *	10/1929	Hoch	D26/85
D191,369 S *	9/1961	Martin	D26/87
D309,955 S *	8/1990	Gismondi	D26/87
D482,818 S *	11/2003	Vegliante	D26/128
D541,971 S *	5/2007	Hamel	D26/85
D634,470 S *	3/2011	Hsieh	D26/118
D659,885 S *	5/2012	Holder	D26/88

D660,501 S *	5/2012	Martin	D26/82
D660,504 S *	5/2012	Martin	D26/136
D668,373 S *	10/2012	Martin	D26/88
D712,583 S *	9/2014	Albicini	D26/88
D741,537 S *	10/2015	Bakker	D26/118
D780,984 S *	3/2017	Urquiola	D26/107
D781,484 S *	3/2017	Urquiola	D26/85
D809,181 S *	1/2018	Calvo Lopez	D26/88
D826,457 S *	8/2018	Amato	D26/86

OTHER PUBLICATIONS

Calla® Collection from Sonneman A Way Of Light. <<https://sonnemanawayoflight.com>> visited Mar. 7, 2019. (Year: 2019).*
Switch Wall Sconce by Javier Robles for Lumifer. Online Catalog © 2018 at lumifer.us. (Year: 2018).*

(Continued)

Primary Examiner — Clare E Heflin

(74) *Attorney, Agent, or Firm* — Gottlieb, Rackman & Reisman, P.C.

(57) **CLAIM**

The ornamental design for a light fixture, as shown and described.

DESCRIPTION

FIG. 1 is a perspective view of a light fixture showing our new design;

FIG. 2 is a first side elevational view thereof;

FIG. 3 is a second side elevational view thereof;

FIG. 4 is a third side elevational view thereof;

FIG. 5 is a fourth side elevational view thereof;

FIG. 6 is a top plan view thereof; and,

FIG. 7 is a bottom plan view thereof.

The broken lines shown in the drawings are included for the purpose of illustrating elements of the light fixture, that is surface mountable, that form no part of the claimed design.

1 Claim, 7 Drawing Sheets

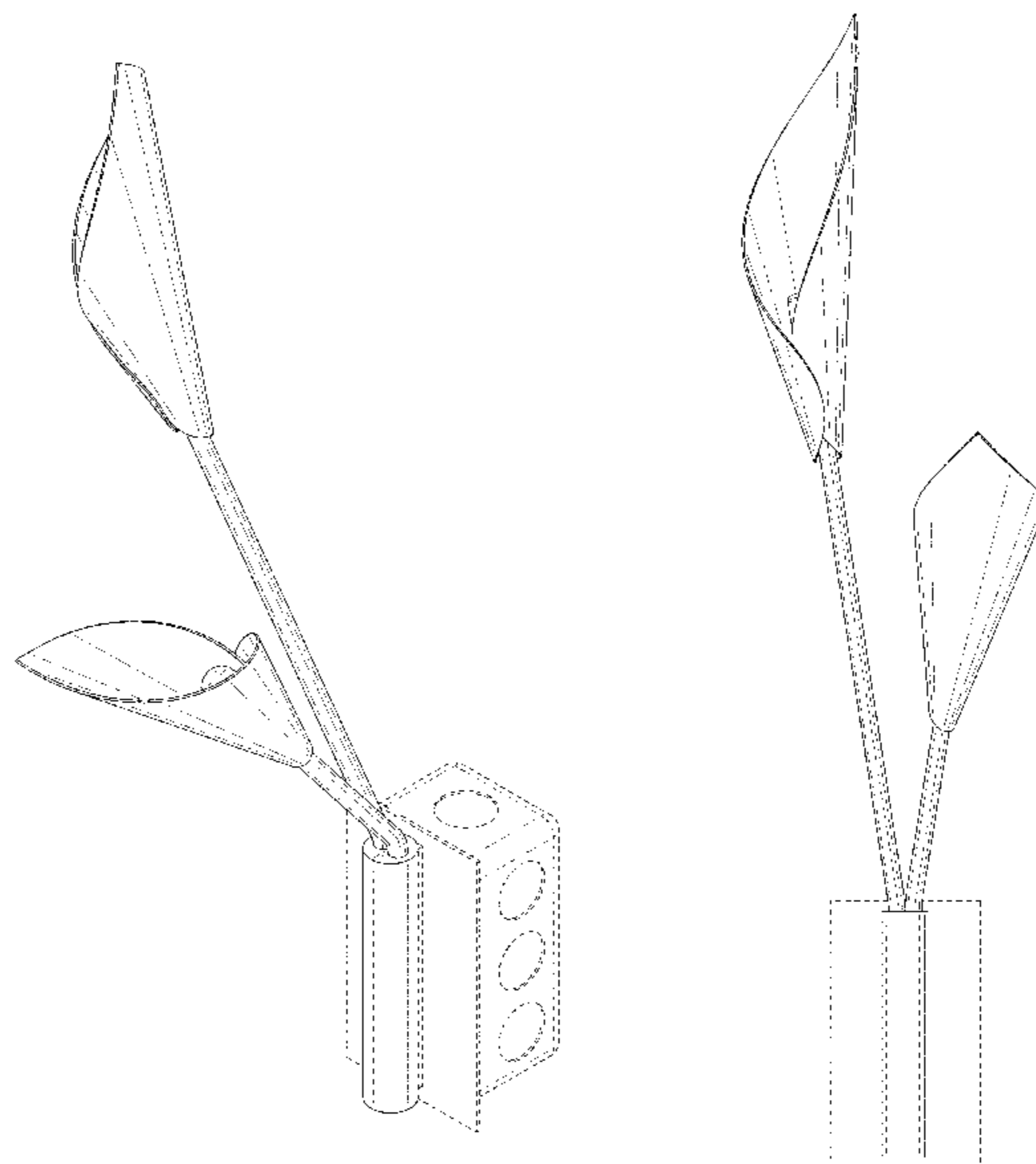

(56)

References Cited

OTHER PUBLICATIONS

Forwin floor lamp. ASIN: B07MRJ5P3N found at amazon.com visited Mar. 7, 2019. (Year: 2019).*

LumiSource—Lili Floor Lamp. Video published at youtube.com Jun. 3, 2013. (Year: 2013).*

Calla Wall Light. Product No. KZC583118 at Lightology.com. Site visited Mar. 7, 2019. (Year: 2019).*

Pappardelle Direct light pendant lamp by Gama Decor found at <archiproducts.com> visited Mar. 7, 2019. (Year: 2019).*

* cited by examiner

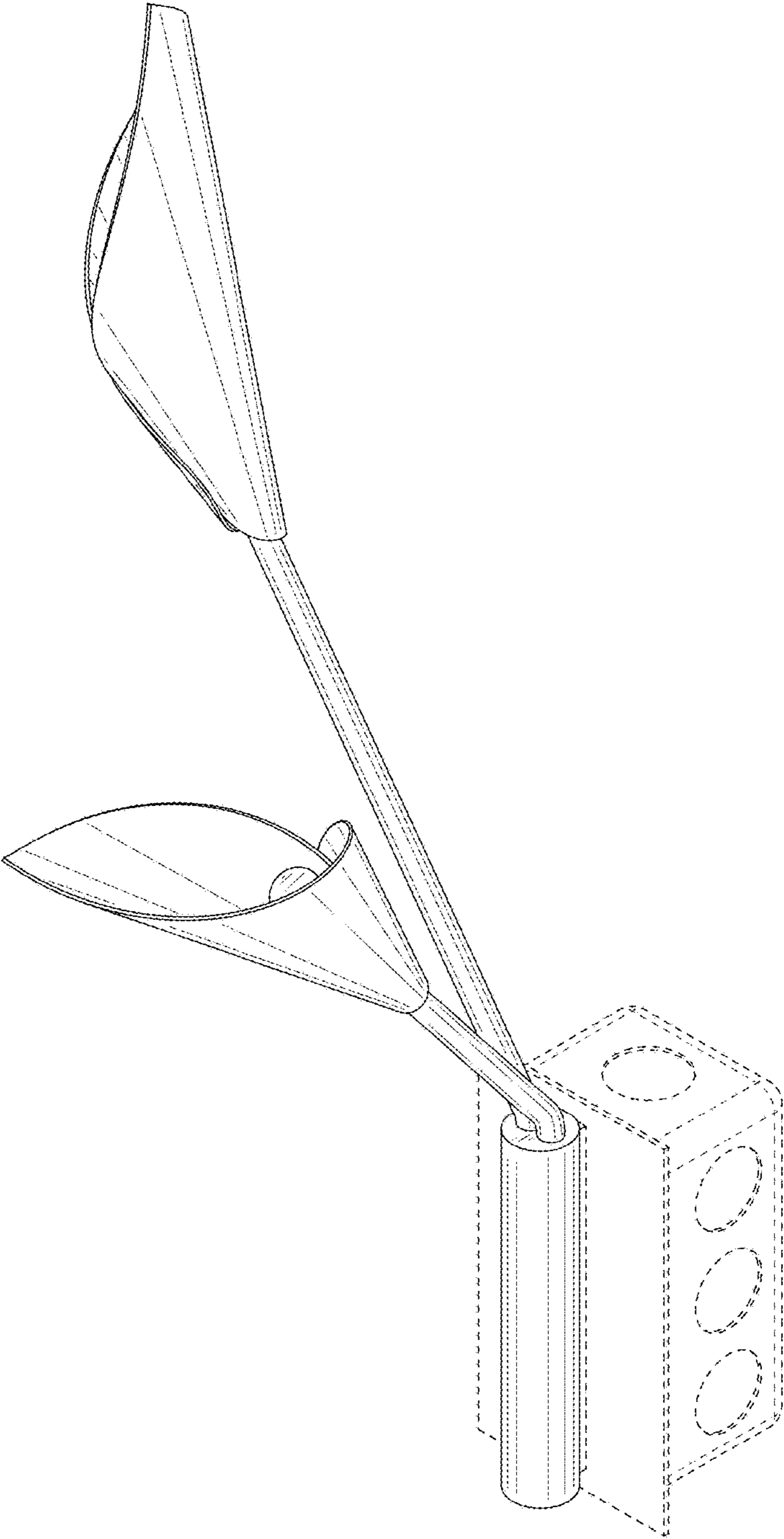

FIG. 1

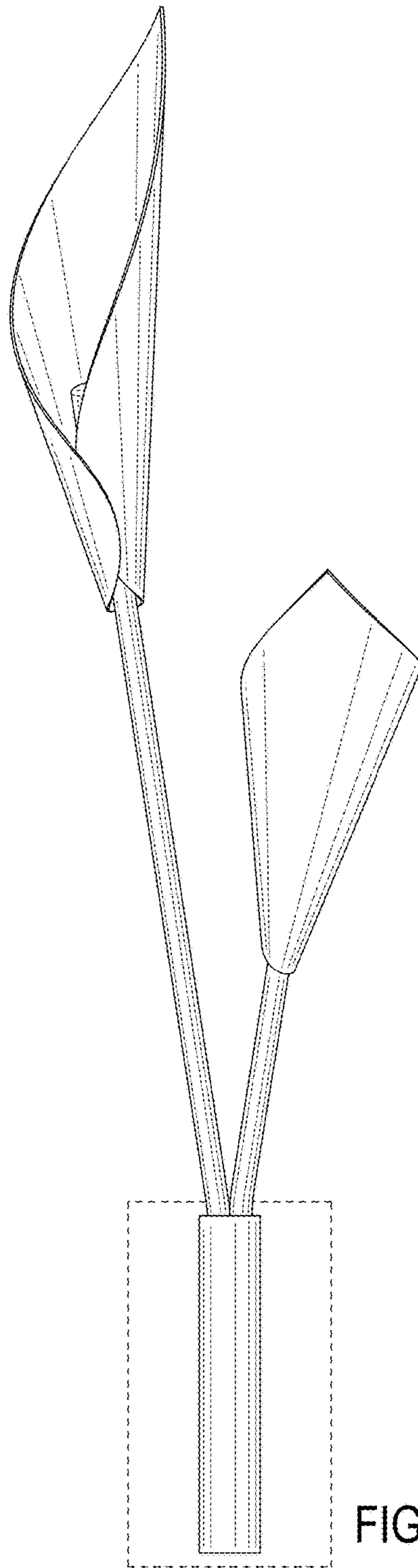

FIG. 2

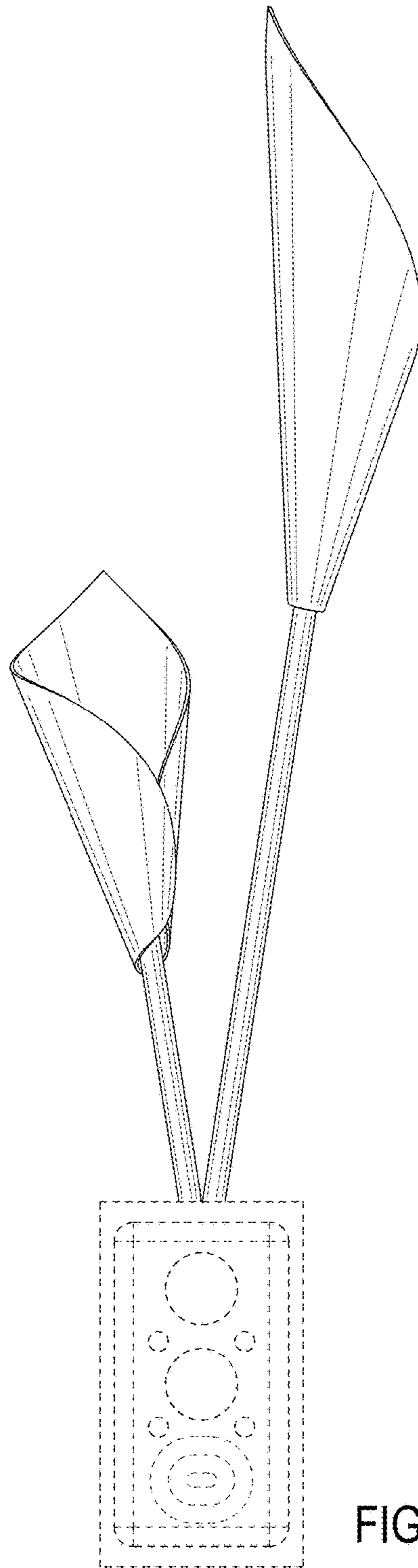
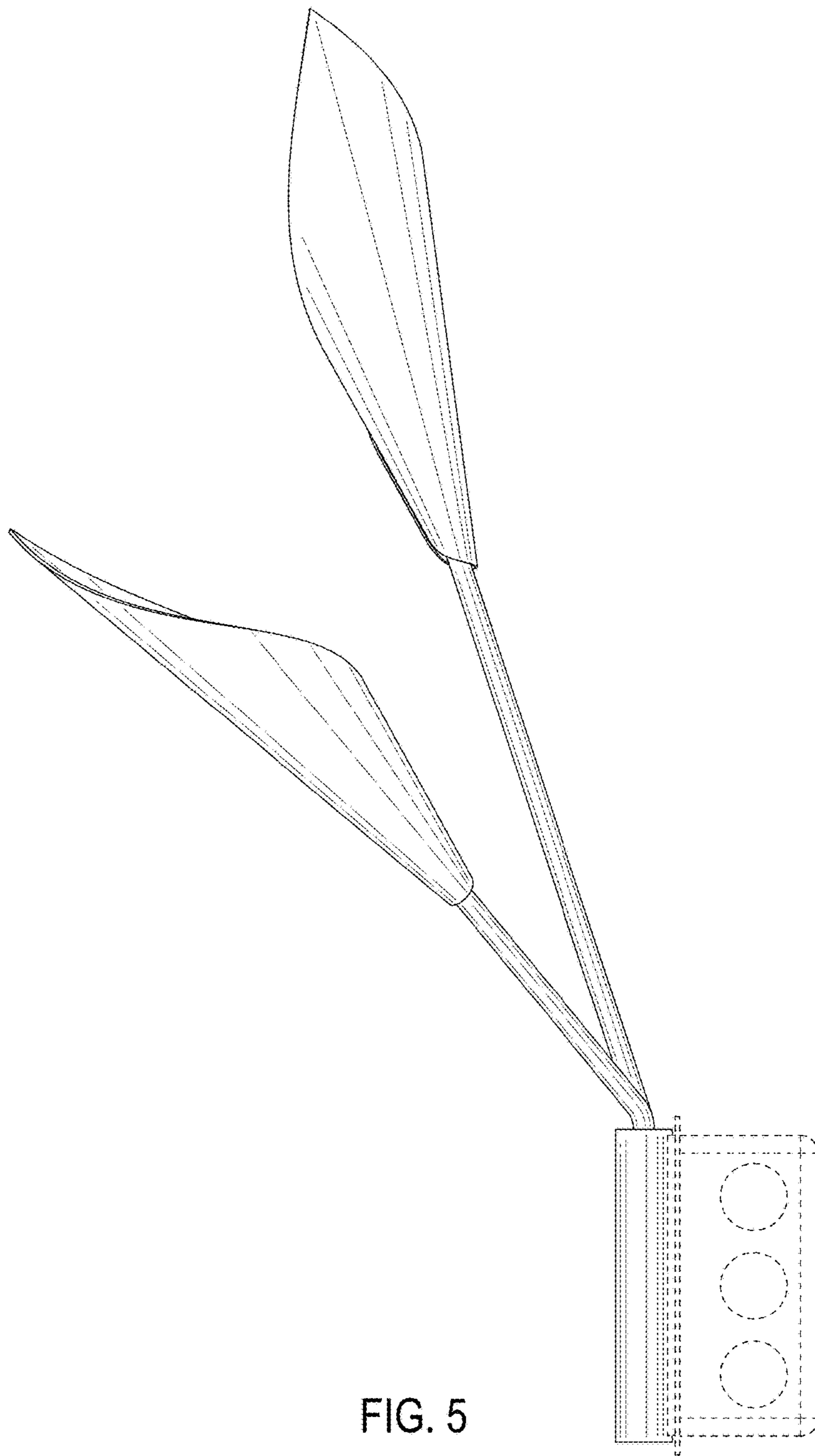

FIG. 3



FIG. 4



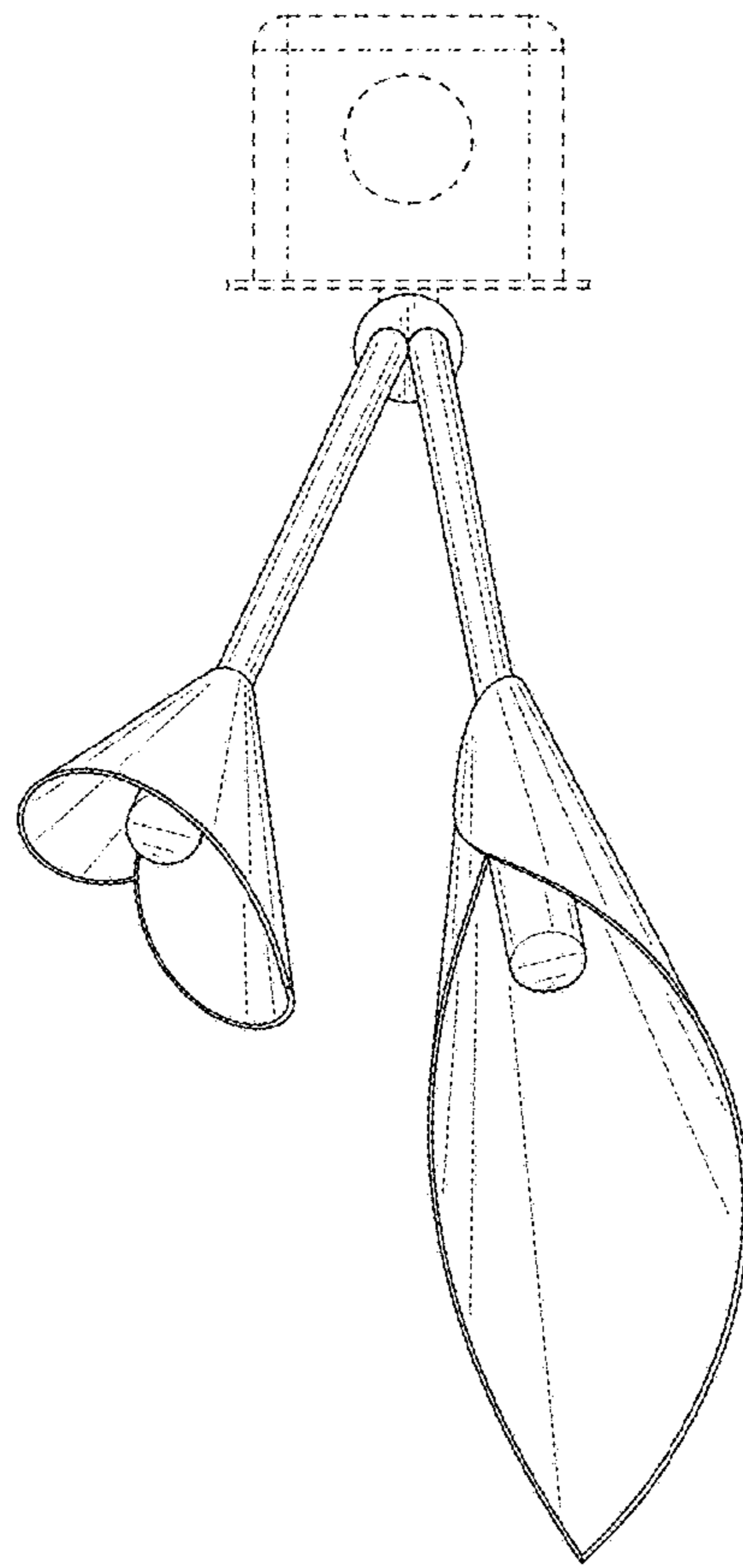

FIG. 6

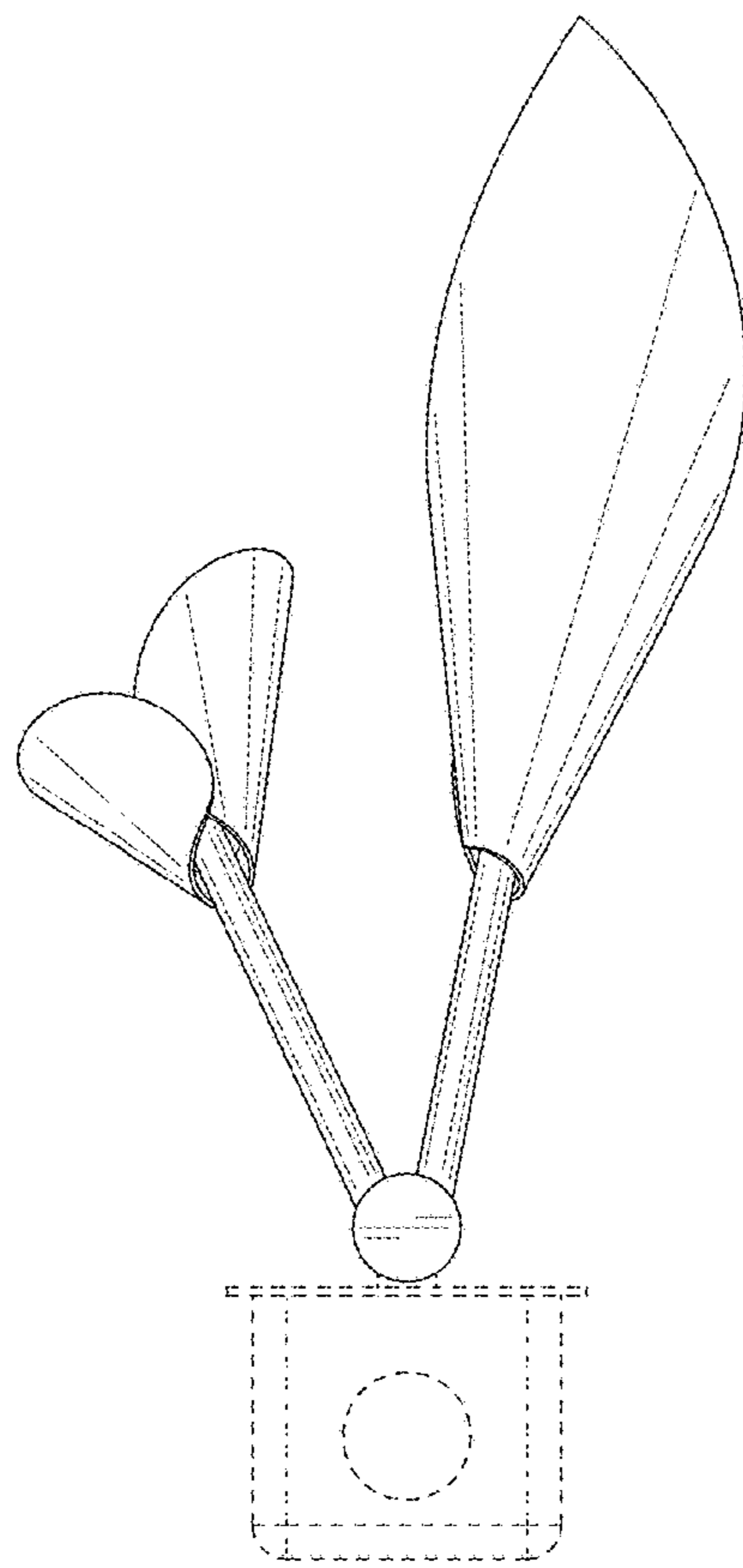

FIG. 7