



US00D855844S

(12) **United States Design Patent**  
**Peng**

(10) **Patent No.:** **US D855,844 S**

(45) **Date of Patent:** **\*\* Aug. 6, 2019**

(54) **LAMP**

(71) Applicant: **Xiao-Ping Peng**, Guangzhou (CN)

(72) Inventor: **Xiao-Ping Peng**, Guangzhou (CN)

(73) Assignee: **GUANGZHOU OVOVS INDUSTRIAL LIGHTING CO., LTD.**, Guangdong (CN)

(\*\*) Term: **15 Years**

(21) Appl. No.: **29/624,555**

(22) Filed: **Nov. 2, 2017**

(51) **LOC (12) Cl.** ..... **26-07**

(52) **U.S. Cl.**  
USPC ..... **D26/28**

(58) **Field of Classification Search**  
USPC ..... D26/28, 29, 30, 31, 32, 33, 34, 35, 36;  
362/459-468, 475-478, 485-487  
CPC ..... F21S 48/00; F21S 48/10; F21S 48/115;  
F21S 48/225; F21S 48/1233; F21S  
48/1266; F21S 48/1388; F21S 48/2268;  
F21V 21/04  
See application file for complete search history.

(56) **References Cited**

**U.S. PATENT DOCUMENTS**

D643,559 S \* 8/2011 Seymour ..... D26/28  
D643,955 S \* 8/2011 Tsai ..... D26/28

D760,406 S \* 6/2016 Huang ..... D26/28  
D788,958 S \* 6/2017 Ko ..... D26/28  
D793,592 S \* 8/2017 Chen ..... D26/28  
D796,095 S \* 8/2017 Huang ..... D26/28  
D798,475 S \* 9/2017 Georgitsis ..... D26/28  
D803,429 S \* 11/2017 Martin ..... D26/28  
D809,167 S \* 1/2018 Chi ..... D26/28  
D815,325 S \* 4/2018 Chi ..... D26/31

\* cited by examiner

*Primary Examiner* — Angela J Lee

(57) **CLAIM**

The ornamental design for a lamp, as shown and described.

**DESCRIPTION**

FIG. 1 is a perspective view of a lamp showing my new design;  
FIG. 2 is a front elevational view thereof;  
FIG. 3 is a top plan view thereof;  
FIG. 4 is a left side elevational view thereof;  
FIG. 5 is a rear elevational view thereof;  
FIG. 6 is a right side view thereof; and,  
FIG. 7 is a bottom plan view thereof.  
The broken lines in the figures represent portions of the lamp which form no part of the claimed design.

**1 Claim, 7 Drawing Sheets**

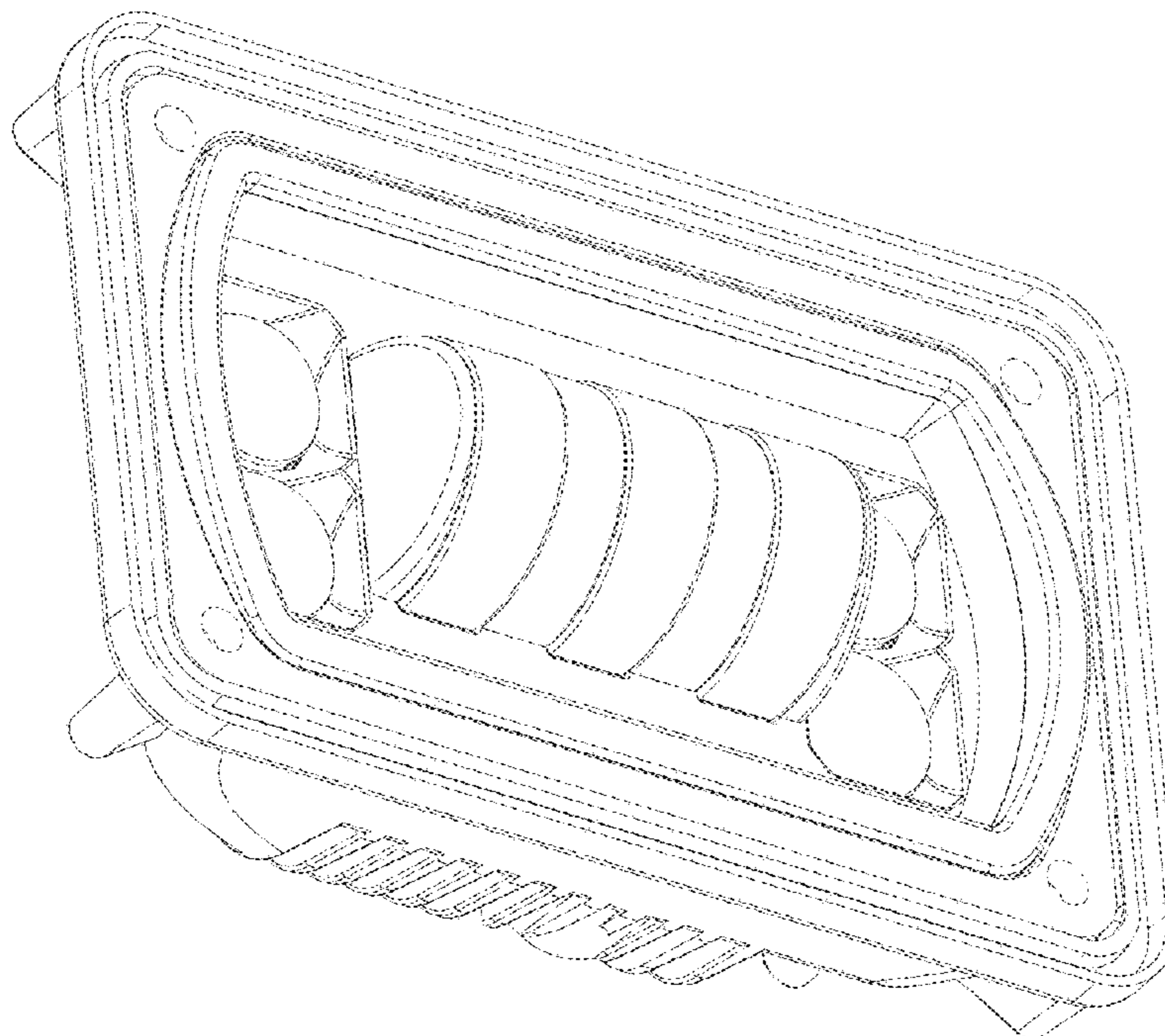

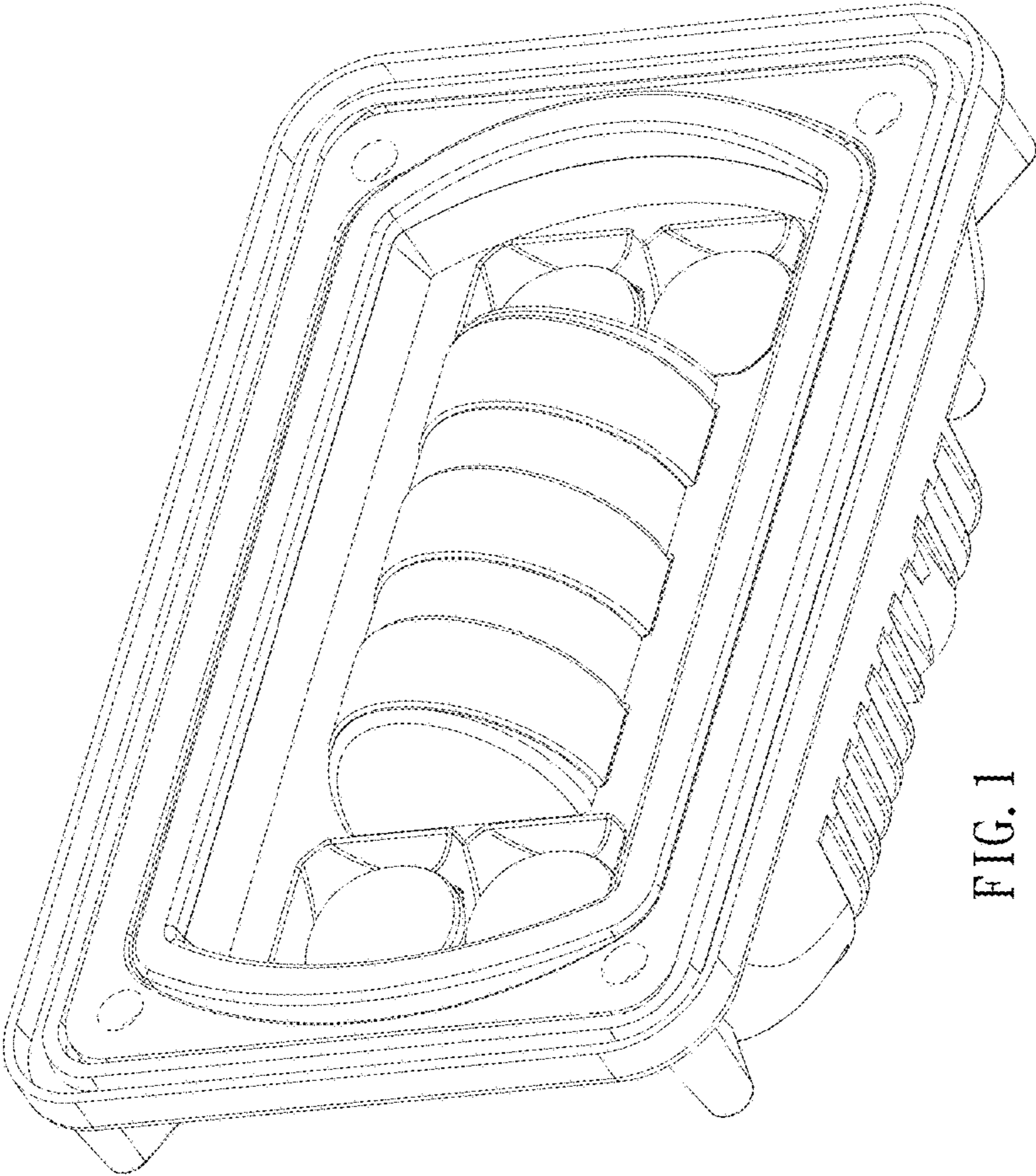

FIG. 1

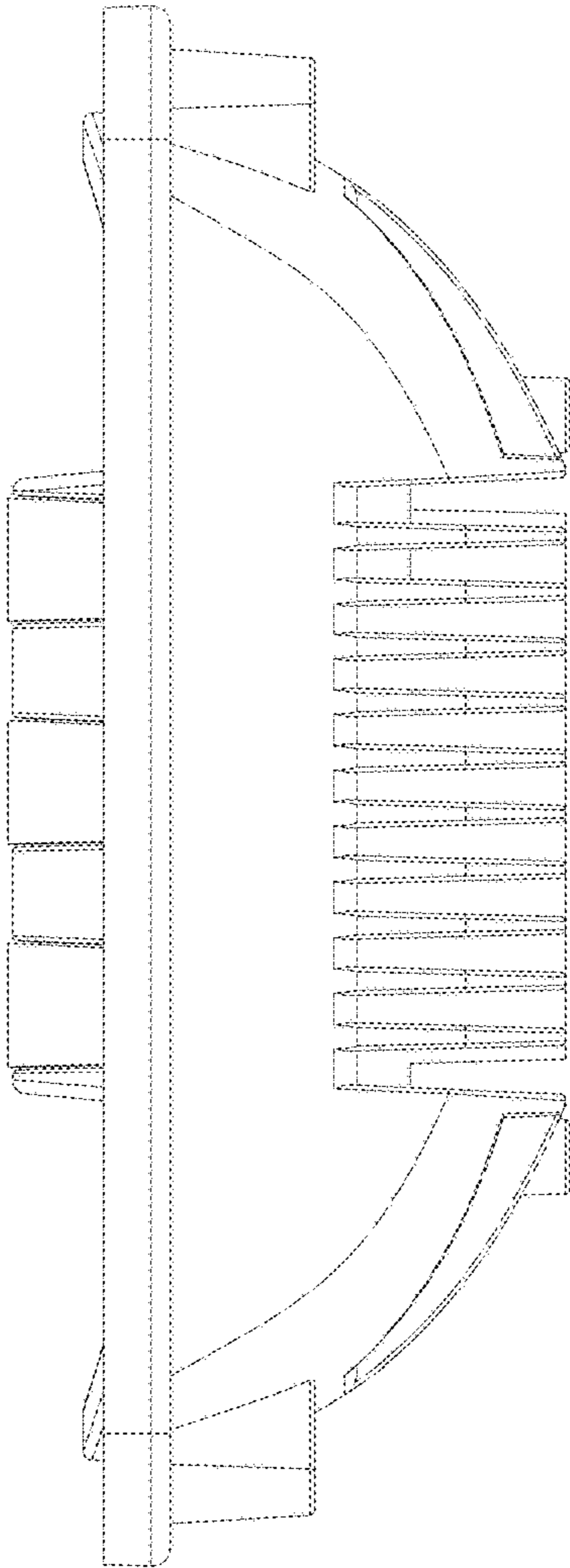

FIG. 2

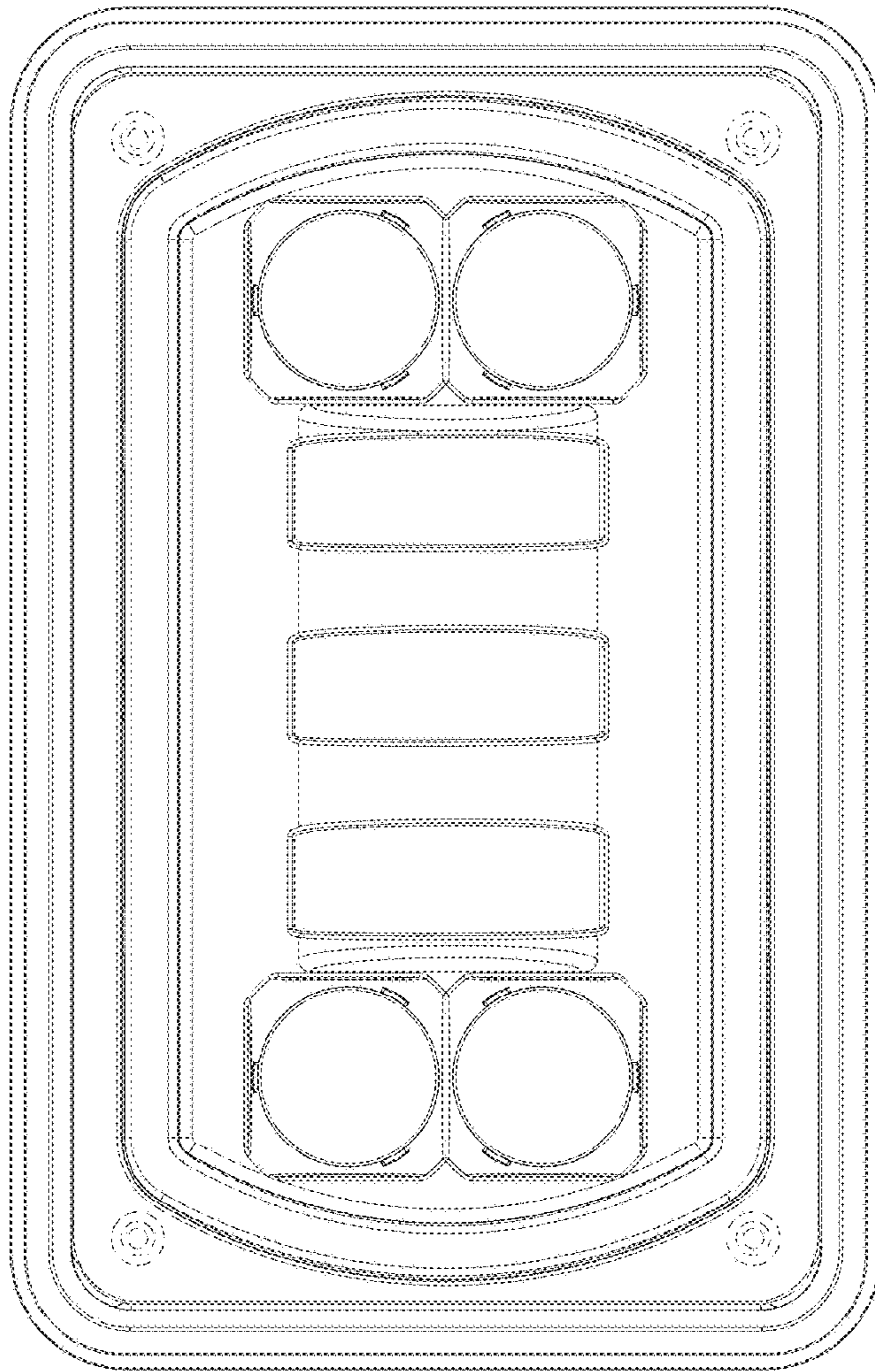

FIG. 3

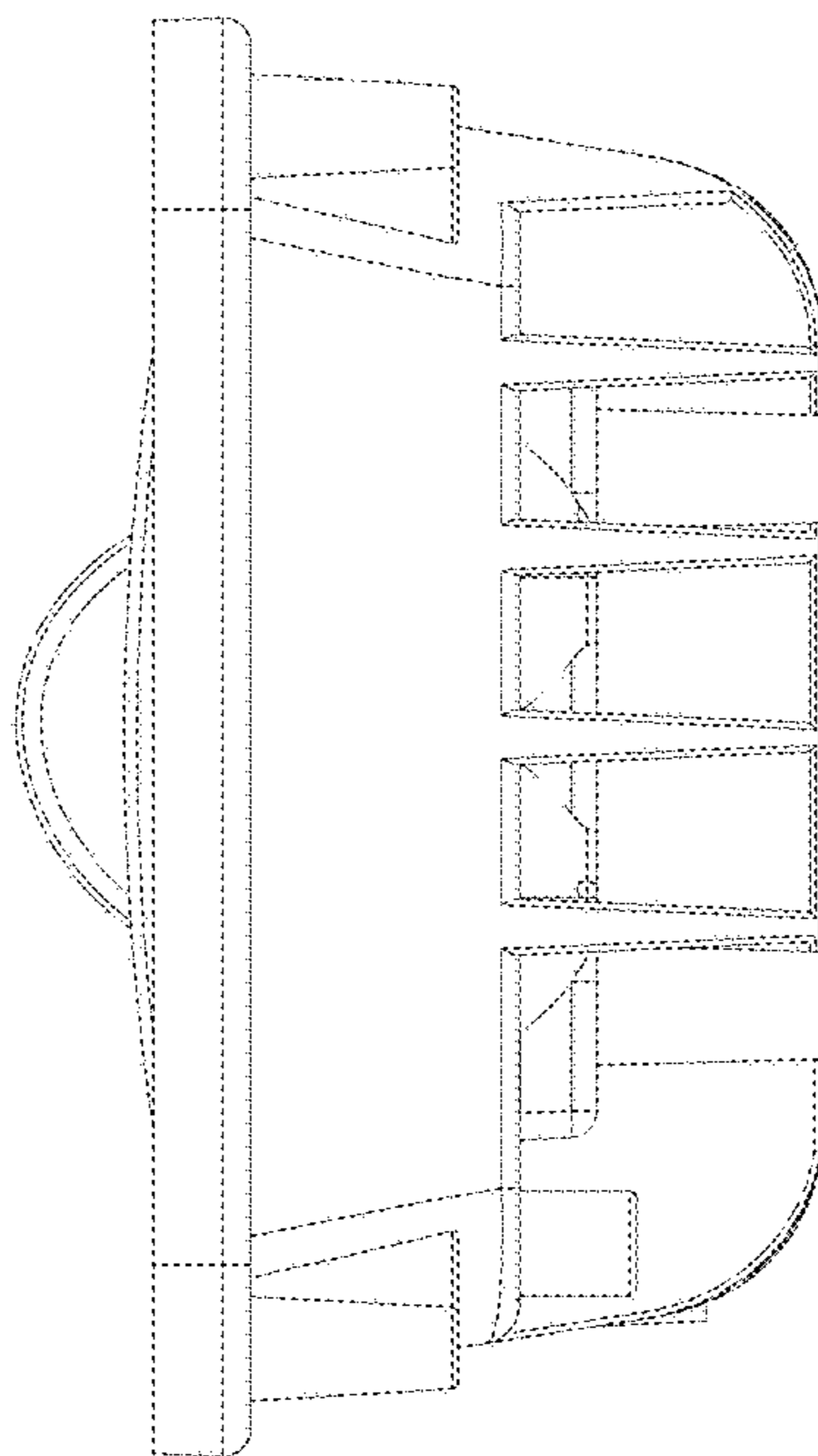

FIG. 4

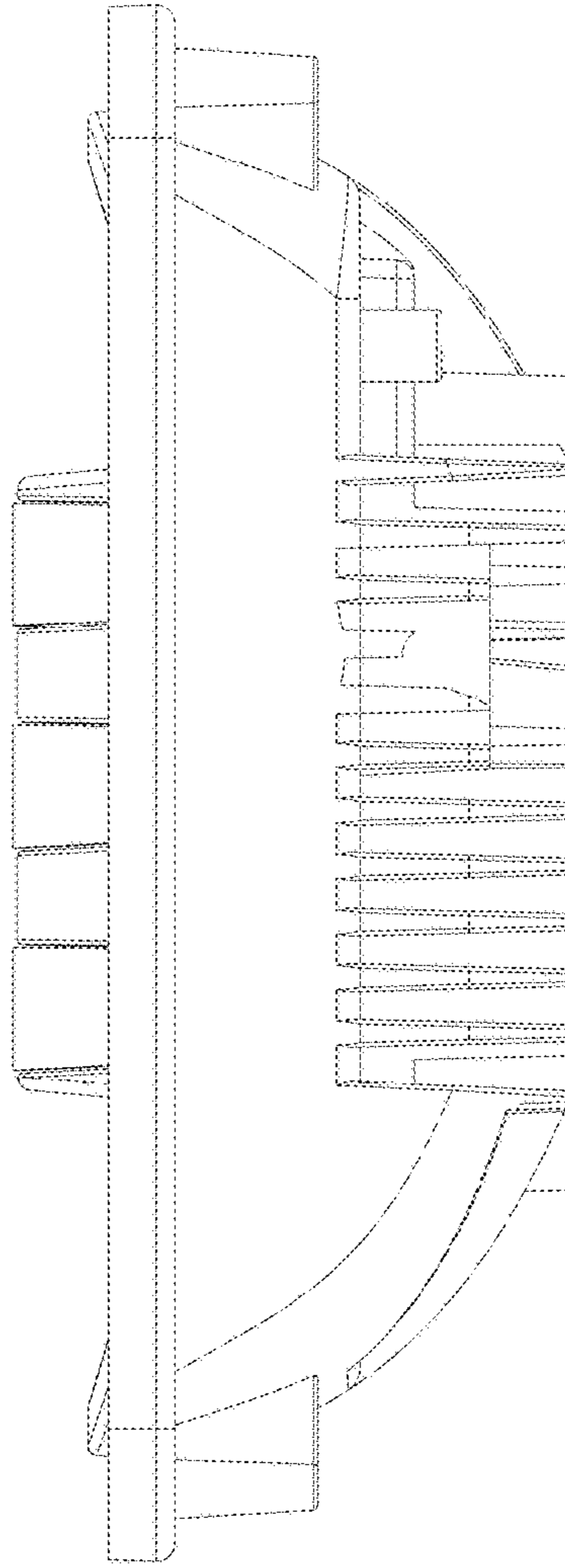

FIG. 5

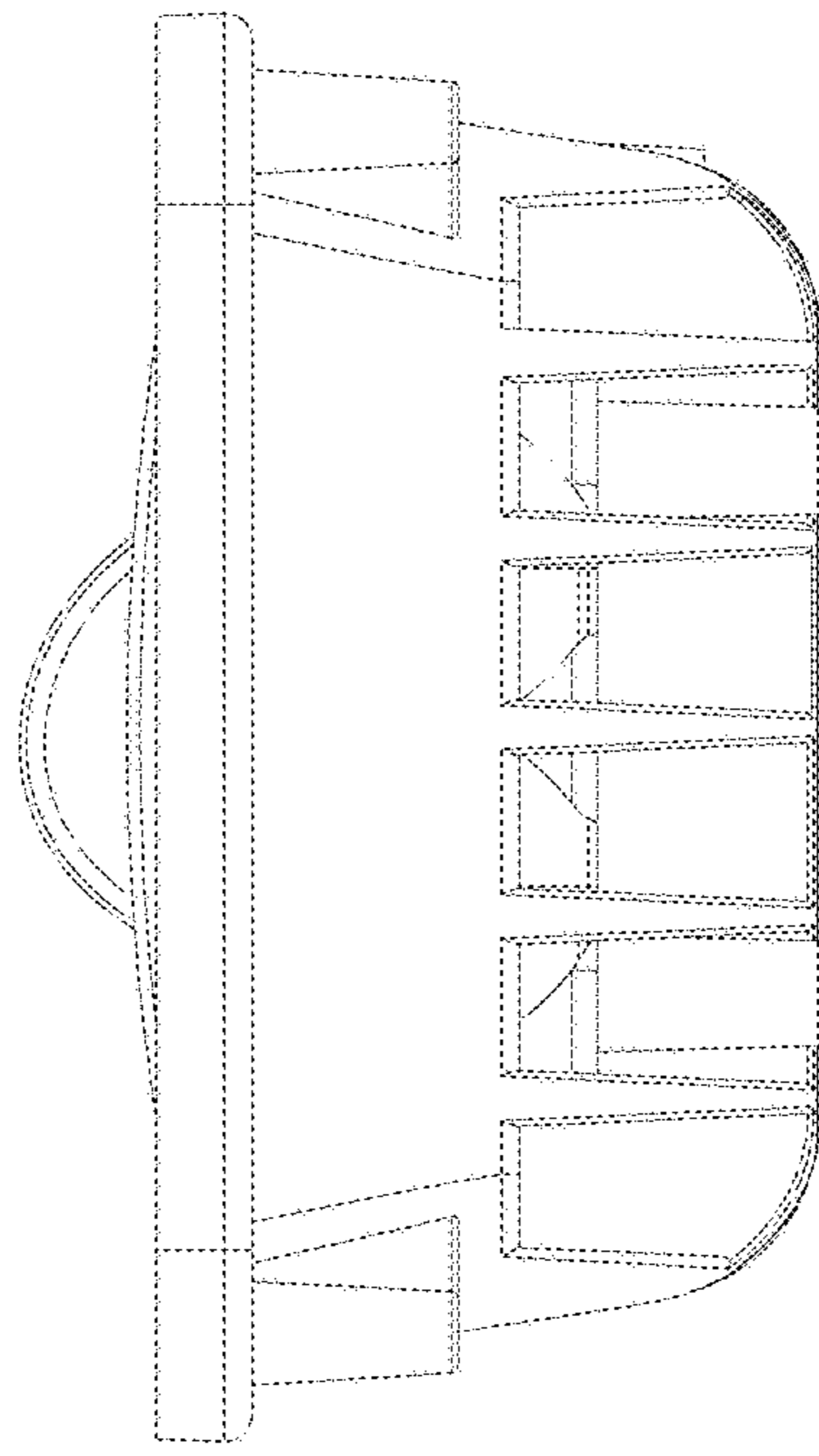

FIG. 6

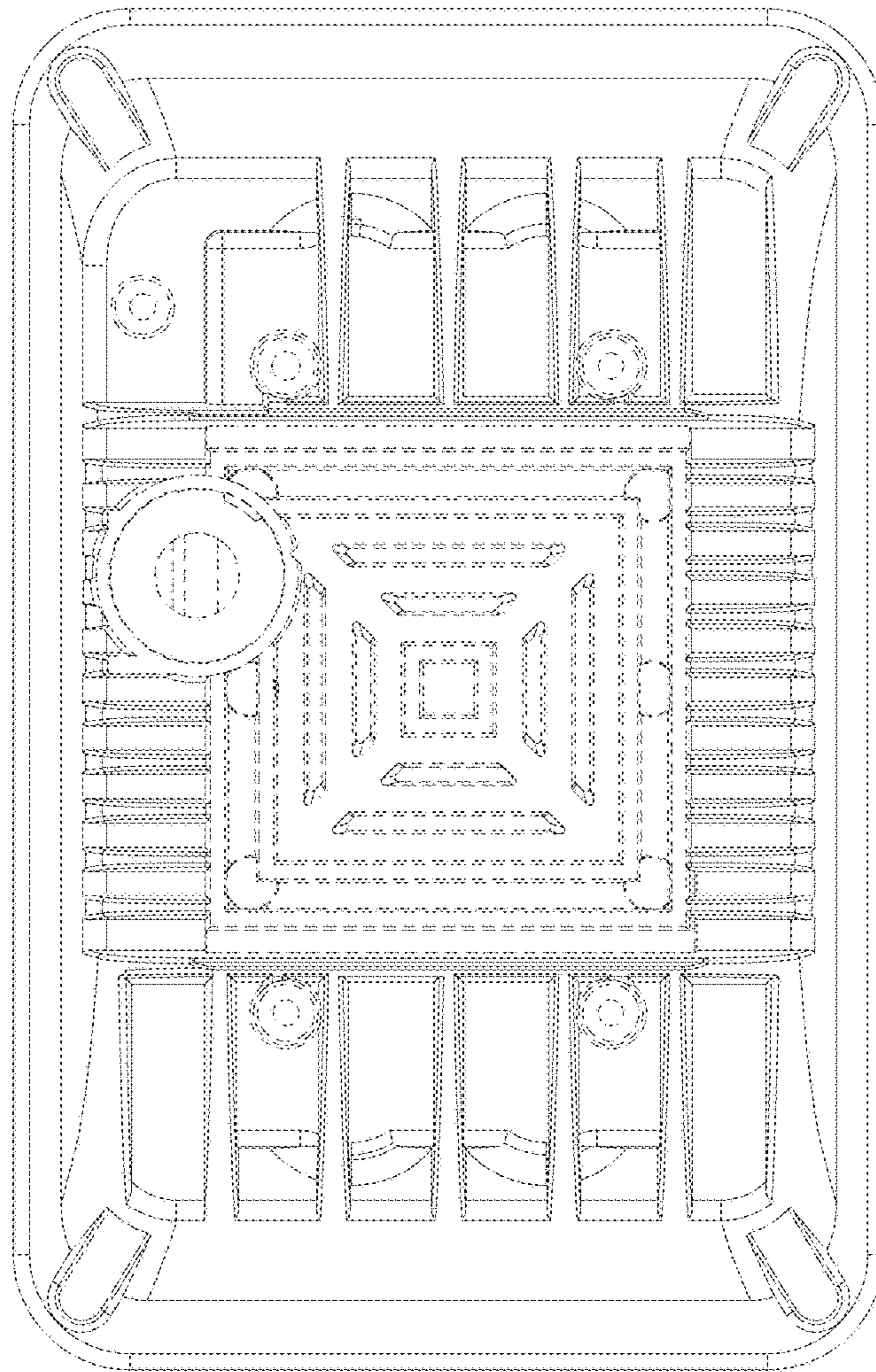

FIG. 7