



US00D855802S

(12) **United States Design Patent** (10) **Patent No.:** **US D855,802 S**
Marcoux et al. (45) **Date of Patent:** **** Aug. 6, 2019**

(54) **DISPOSABLE TOOL**

FOREIGN PATENT DOCUMENTS

(71) Applicant: **Interscope, Inc.**, Whitinsville, MA (US)

DE 33 39 322 A1 5/1984
DE 33 20 076 A1 12/1984

(72) Inventors: **Michael Walter Marcoux**, Jamaica Plain, MA (US); **Kristen Dodds Weight**, Stow, MA (US); **Sarah Kostanski**, Chelmsford, MA (US); **Jeffery Bennith Ryan, Jr.**, Whitinsville, MA (US)

(Continued)

OTHER PUBLICATIONS

Canadian Examination Report on CA Application No. 2911545 dated Nov. 20, 2015.

(Continued)

(73) Assignee: **Interscope, Inc.**, Whitinsville, MA (US)

Primary Examiner — Eliza Z Bennett-Hattan

(**) Term: **15 Years**

(74) *Attorney, Agent, or Firm* — Foley & Lardner LLP

(21) Appl. No.: **29/545,290**

(57) **CLAIM**

(22) Filed: **Nov. 11, 2015**

We claim the ornamental design for a disposable tool, as shown and described.

DESCRIPTION

Related U.S. Application Data

(63) Continuation-in-part of application No. 14/501,957, filed on Sep. 30, 2014, now Pat. No. 9,204,868, which
(Continued)

(51) **LOC (12) Cl.** **24-02**

(52) **U.S. Cl.**
USPC **D24/138**

(58) **Field of Classification Search**
USPC D24/108, 113, 127, 138, 137, 133, 147,
D24/144

(Continued)

(56) **References Cited**

U.S. PATENT DOCUMENTS

3,760,810 A 9/1973 Van Hoorn
3,834,392 A 9/1974 Lampman et al.

(Continued)

FIG. 1 is a bottom, front, left perspective view of the claimed design;

FIG. 2 is a top, rear, right perspective view thereof;

FIG. 3 is a front elevation view thereof;

FIG. 4 is a rear elevation view thereof;

FIG. 5 is a top plan view thereof;

FIG. 6 is a bottom plan view thereof;

FIG. 7 is a left elevation view thereof; and,

FIG. 8 is a right elevation view thereof.

The ornamental design which is claimed is shown in solid lines in the drawings.

The broken lines in the drawings form no part of the claimed design. Broken lines formed by equal length dashes show unclaimed subject matter. Broken lines formed of unequal length dashes (i.e., dash-dot) define bounds of the claimed design.

The disposable tool is shown with a symbolic break in its length. The appearance of any portion of the article between the break lines forms no part of the claimed design.

The unshaded areas form no part of the claim.

1 Claim, 6 Drawing Sheets

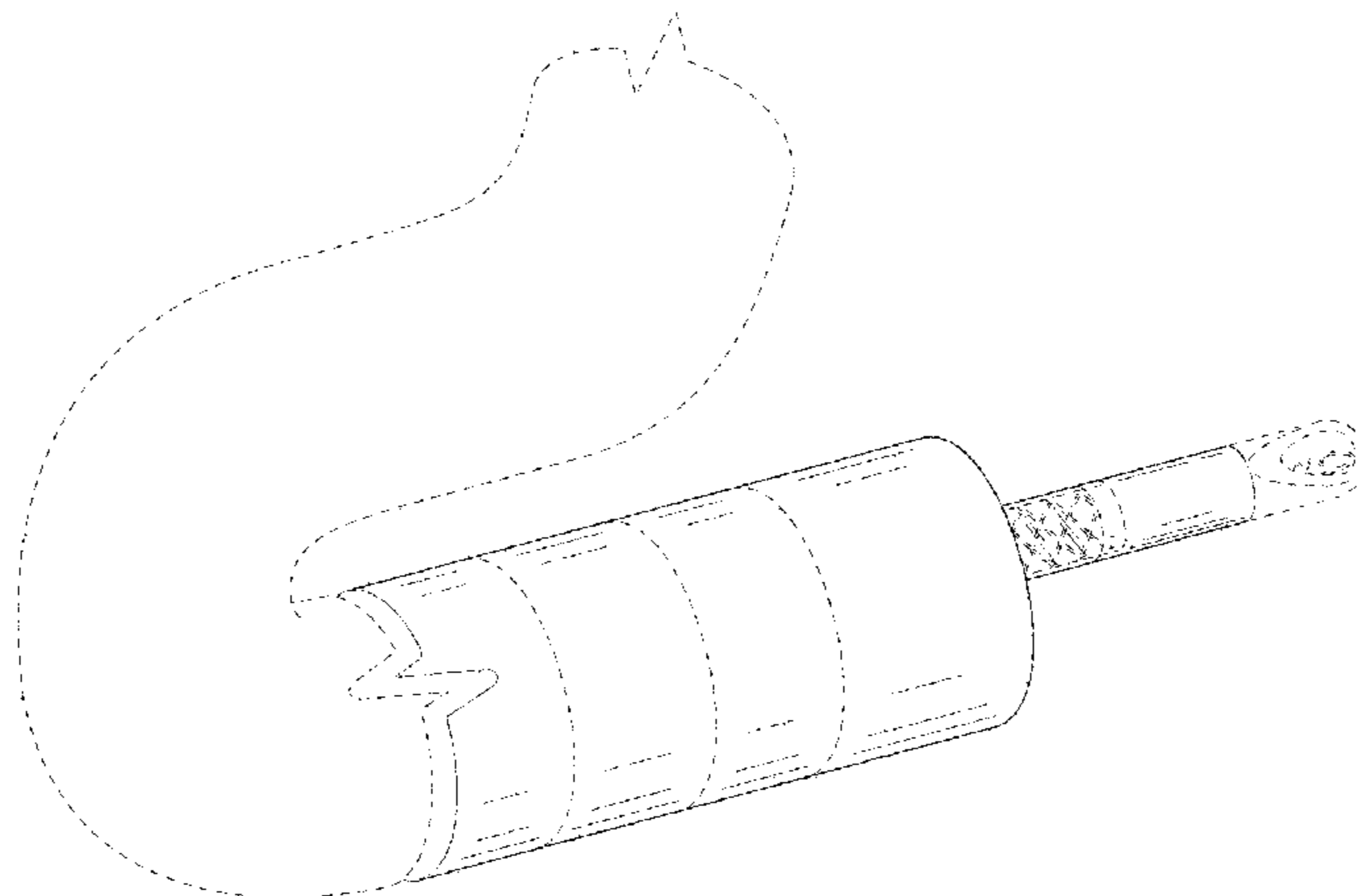

Related U.S. Application Data

is a continuation-in-part of application No. 14/280,202, filed on May 16, 2014, now Pat. No. 8,882,680, which is a continuation-in-part of application No. 13/336,491, filed on Dec. 23, 2011, now Pat. No. 9,808,146.

(58) **Field of Classification Search**

CPC A61B 1/005
See application file for complete search history.

(56) **References Cited**

U.S. PATENT DOCUMENTS

3,911,923	A	10/1975	Yoon	
4,222,380	A	9/1980	Terayama	
4,226,239	A	10/1980	Polk et al.	
4,257,419	A	3/1981	Goltner et al.	
4,548,201	A	10/1985	Yoon	
4,646,738	A	3/1987	Trott	
4,756,309	A	7/1988	Sachse et al.	
4,763,667	A	8/1988	Manzo	
4,834,729	A	5/1989	Sjostrom	
4,950,278	A	8/1990	Sachse et al.	
4,966,162	A	10/1990	Wang	
5,259,366	A *	11/1993	Reydel	A61B 1/00135 383/203
5,269,789	A	12/1993	Chin et al.	
5,320,630	A	6/1994	Ahmed	
5,320,635	A	6/1994	Smith	
5,349,940	A	9/1994	Takahashi et al.	
5,417,697	A	5/1995	Wilk et al.	
5,423,834	A	6/1995	Ahmed	
5,462,559	A	10/1995	Ahmed	
5,507,797	A	4/1996	Suzuki et al.	
5,529,580	A	6/1996	Kusunoki et al.	
5,662,671	A	9/1997	Barbut et al.	
5,871,453	A	2/1999	Banik et al.	
5,961,534	A	10/1999	Banik et al.	
6,010,515	A *	1/2000	Swain	A61B 1/00089 600/104
6,059,719	A	5/2000	Yamamoto et al.	
6,068,603	A	5/2000	Suzuki	
6,193,672	B1	2/2001	Clement	
6,245,011	B1	6/2001	Dudda et al.	
6,517,560	B1	2/2003	Toth et al.	
6,572,578	B1	6/2003	Blanchard	
6,585,694	B1	7/2003	Smith et al.	
6,645,218	B1	11/2003	Cassidy et al.	
6,666,854	B1	12/2003	Lange	
6,689,146	B1	2/2004	Himes	
6,740,030	B2 *	5/2004	Martone	A61B 1/00071 600/104
7,247,161	B2	7/2007	Johnston et al.	
7,276,074	B2	10/2007	Adams et al.	
7,625,347	B2	12/2009	Burbank et al.	
7,691,110	B2	4/2010	Secrest et al.	
7,857,784	B2	12/2010	Schmidberger et al.	
8,070,756	B2	12/2011	Secrest et al.	
8,070,762	B2	12/2011	Escudero et al.	
8,123,750	B2	2/2012	Norton et al.	
8,277,474	B2	10/2012	Norman et al.	
8,343,047	B2 *	1/2013	Albrecht	A61B 1/32 600/206
8,435,259	B2	5/2013	Dierck	
8,475,484	B2	7/2013	Wulfman et al.	
8,480,689	B2 *	7/2013	Spivey	A61B 17/06066 606/144
8,506,564	B2 *	8/2013	Long	A61B 18/1477 606/41
8,528,563	B2	9/2013	Gruber	
8,574,254	B2	11/2013	Hedstrom et al.	
8,696,621	B2	4/2014	Gunday et al.	
8,939,897	B2 *	1/2015	Nobis	A61B 1/2736 600/127

9,005,220	B2 *	4/2015	Wallace	A61B 17/0469 606/144
9,095,367	B2	8/2015	Olson et al.	
2002/0013570	A1	1/2002	Ruegg et al.	
2003/0055315	A1	3/2003	Gatto et al.	
2004/0147934	A1	7/2004	Kiester	
2004/0162572	A1	8/2004	Sauer	
2005/0090848	A1	4/2005	Adams	
2005/0159767	A1	7/2005	Adams et al.	
2005/0272976	A1	12/2005	Tanaka et al.	
2006/0064113	A1 *	3/2006	Nakao	A61B 10/06 606/113
2007/0197871	A1	8/2007	Geitz et al.	
2007/0203395	A1 *	8/2007	Mikkaichi	A61B 1/00087 600/127
2008/0082021	A1	4/2008	Ichikawa et al.	
2008/0183201	A1	7/2008	Berberich	
2008/0194910	A1	8/2008	Miyamoto et al.	
2008/0234602	A1	9/2008	Oostman et al.	
2009/0069806	A1	3/2009	De La Mora Levy et al.	
2009/0234378	A1	9/2009	Escudero et al.	
2009/0240261	A1	9/2009	Drews et al.	
2010/0010525	A1	1/2010	Lockard et al.	
2010/0016757	A1 *	1/2010	Greenburg	A61B 1/0125 600/562
2010/0036375	A1	2/2010	Regadas	
2010/0048992	A1	2/2010	Okada et al.	
2010/0081874	A1	4/2010	Miyamoto et al.	
2010/0121141	A1	5/2010	Rontal	
2010/0168512	A1	7/2010	Rahmani	
2010/0217245	A1	8/2010	Prescott	
2010/0298855	A1	11/2010	Dierck	
2011/0257477	A1 *	10/2011	McWeeney	A61B 1/00073 600/104
2011/0270126	A1	11/2011	Gunday et al.	
2012/0109130	A1	5/2012	Casey et al.	
2012/0226101	A1	9/2012	Tinkham et al.	
2012/0226103	A1	9/2012	Gunday et al.	
2013/0016316	A1	1/2013	Cheng et al.	
2013/0046313	A1	2/2013	Sullivan et al.	
2013/0046316	A1	2/2013	Sullivan et al.	
2013/0103067	A1	4/2013	Fabro et al.	
2013/0190561	A1	7/2013	Oskin et al.	
2014/0100567	A1	4/2014	Edwards et al.	
2014/0155923	A1	6/2014	Edwards et al.	
2014/0236165	A1	8/2014	Ries et al.	
2014/0249448	A1 *	9/2014	Furlong	A61B 10/04 600/563

FOREIGN PATENT DOCUMENTS

DE	19522403	A1	9/1997
EP	0 609 084	A2	8/1994
EP	1 586 275		10/2005
EP	1 875 871	A2	9/2008
WO	WO-95/30377		11/1995
WO	WO-01/22889		4/2001
WO	WO-2006/122279		11/2006
WO	WO-2012/075409	A1	6/2012

OTHER PUBLICATIONS

International Preliminary Report on Patentability dated Nov. 26, 2015 in PCT Application No. PCT/US2014/038443.
International Preliminary Report on Patentability dated Jun. 12, 2014 in PCT Application No. PCT/US2012/067614.
International Search Report and Written Opinion dated May 28, 2013 in PCT App. No. PCT/US2012/067614.
International Search Report and Written Opinion for International Patent Application No. PCT/US2014/038443 dated Sep. 1, 2014.
International Search Report and Written Opinion of the International Searching Authority for International Application No. PCT/US2015/052977 dated Dec. 18, 2015.
International Search Report and Written Opinion of the International Searching Authority for International Application No. PCT/US2015/052979 dated Dec. 17, 2015.

(56)

References Cited

OTHER PUBLICATIONS

International Search Report and Written Opinion of the International Searching Authority on International Application No. PCT/US2015/052978 dated Dec. 17, 2015.

U.S. Notice of Allowance in U.S. Appl. No. 14/501,942 dated Mar. 18, 2015.

U.S. Notice of Allowance in U.S. Appl. No. 14/501,957 dated Oct. 21, 2015.

U.S. Notice of Allowance in U.S. Appl. No. 14/280,202 dated Oct. 7, 2014.

U.S. Notice of Allowance in U.S. Appl. No. 14/501,865 dated Feb. 20, 2015.

U.S. Notice of Allowance in U.S. Appl. No. 14/537,362 dated May 26, 2015.

U.S. Office Action for U.S. Appl. No. 14/501,957 dated Nov. 14, 2014 (INT-106US).

U.S. Office Action in U.S. Appl. No. 14/501,957 dated Mar. 19, 2015.

U.S. Office Action in U.S. Appl. No. 14/280,202 dated Aug. 20, 2014.

U.S. Office Action in U.S. Appl. No. 14/501,865 dated Dec. 4, 2014.

U.S. Office Action in U.S. Appl. No. 14/501,932 dated Nov. 26, 2014.

U.S. Office Action in U.S. Appl. No. 14/501,942 dated Dec. 15, 2014.

U.S. Office Action in U.S. Appl. No. 14/537,362 dated Feb. 11, 2015.

U.S. Office Action on U.S. Appl. No. 13/336,491 dated Sep. 18, 2015.

First Office Action issued on Feb. 3, 2016 in Chinese Patent Application No. 201280068003.8.

Office Action in European Patent Application No. 14731875.2 dated Feb. 12, 2016.

U.S. Office Action for U.S. Appl. No. 13/336,491 dated Mar. 2, 2016.

U.S. Office Action for U.S. Appl. No. 14/316,203 dated Mar. 15, 2016.

* cited by examiner

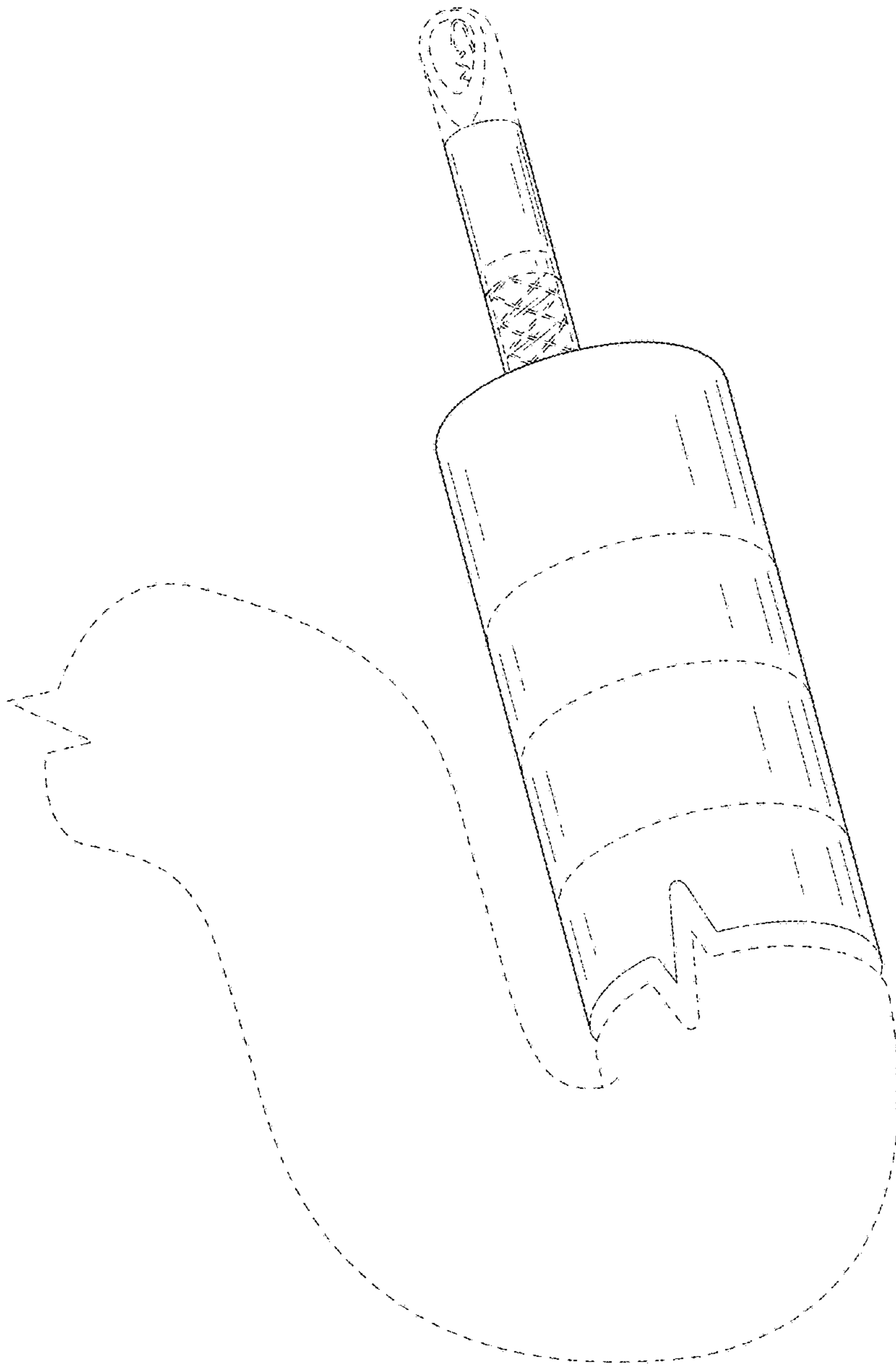

FIG. 1

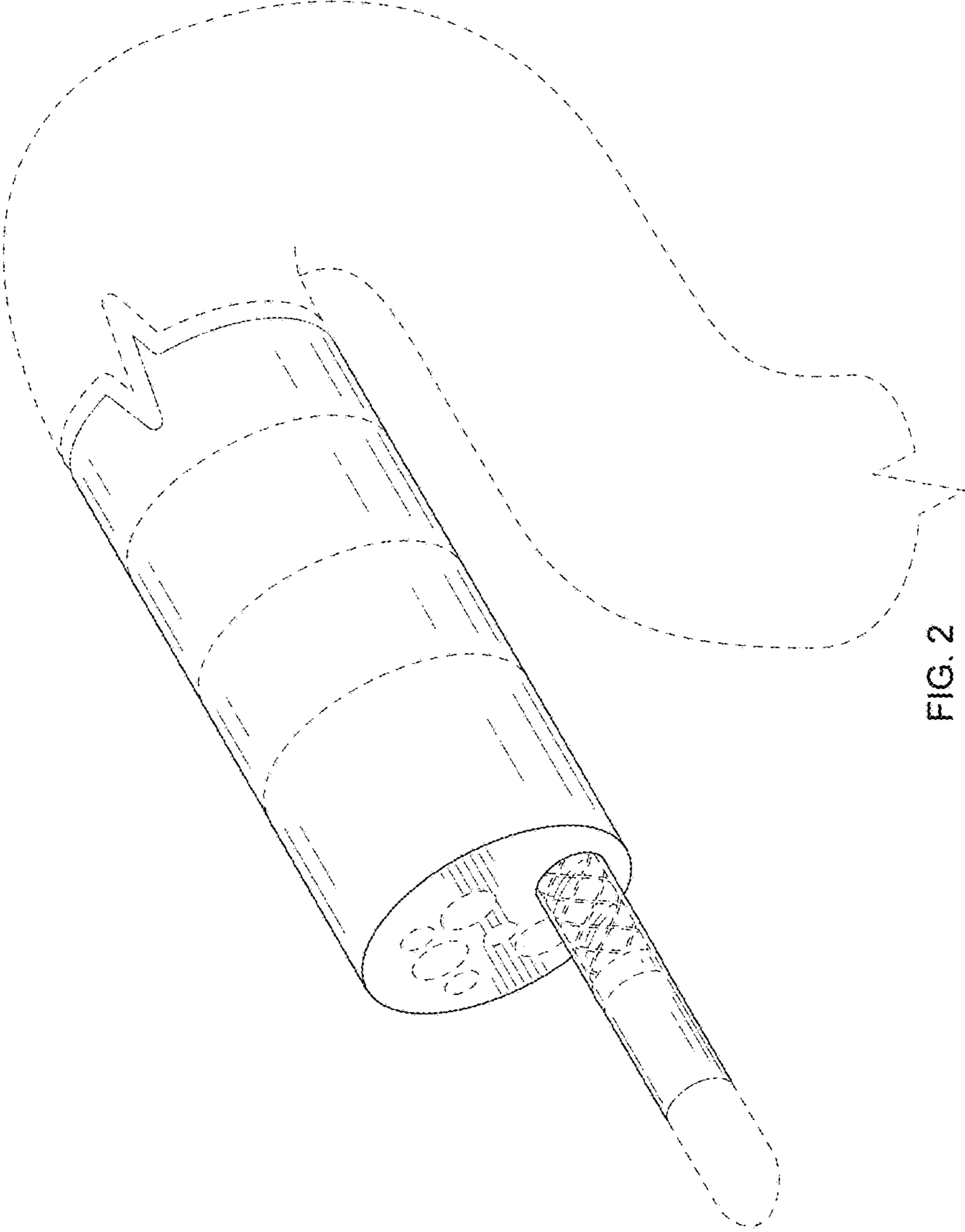

FIG. 2

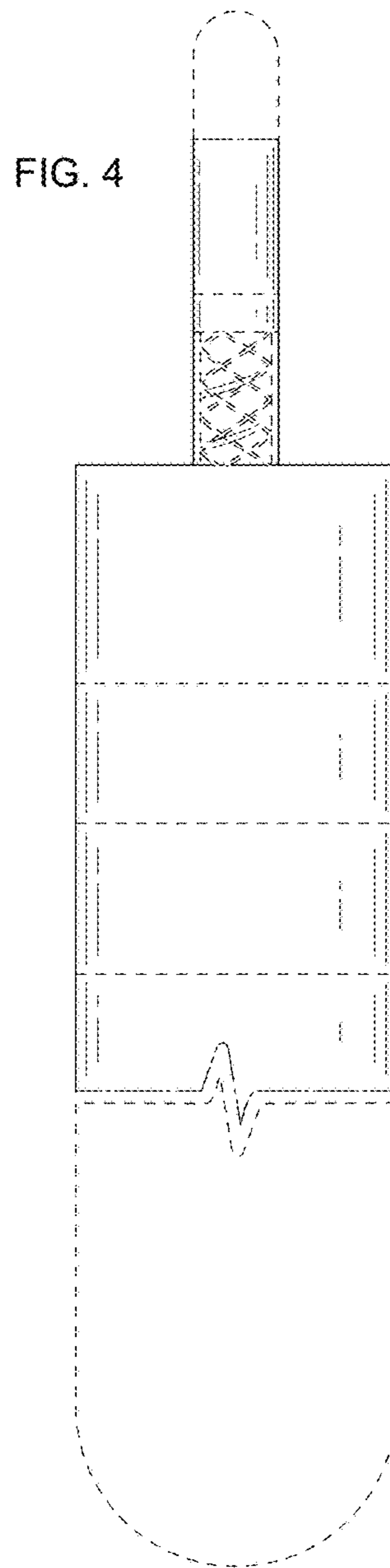
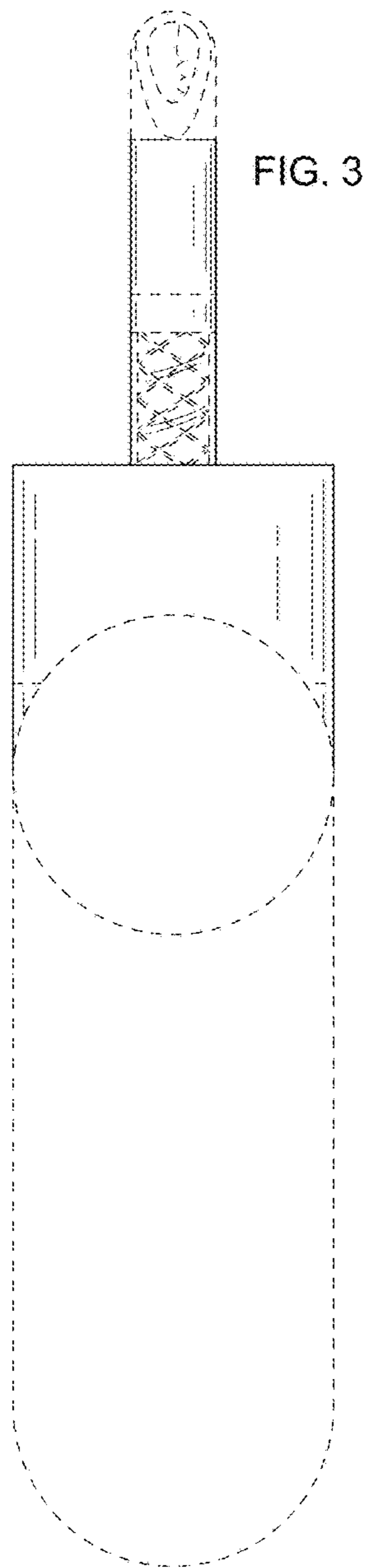

FIG. 5

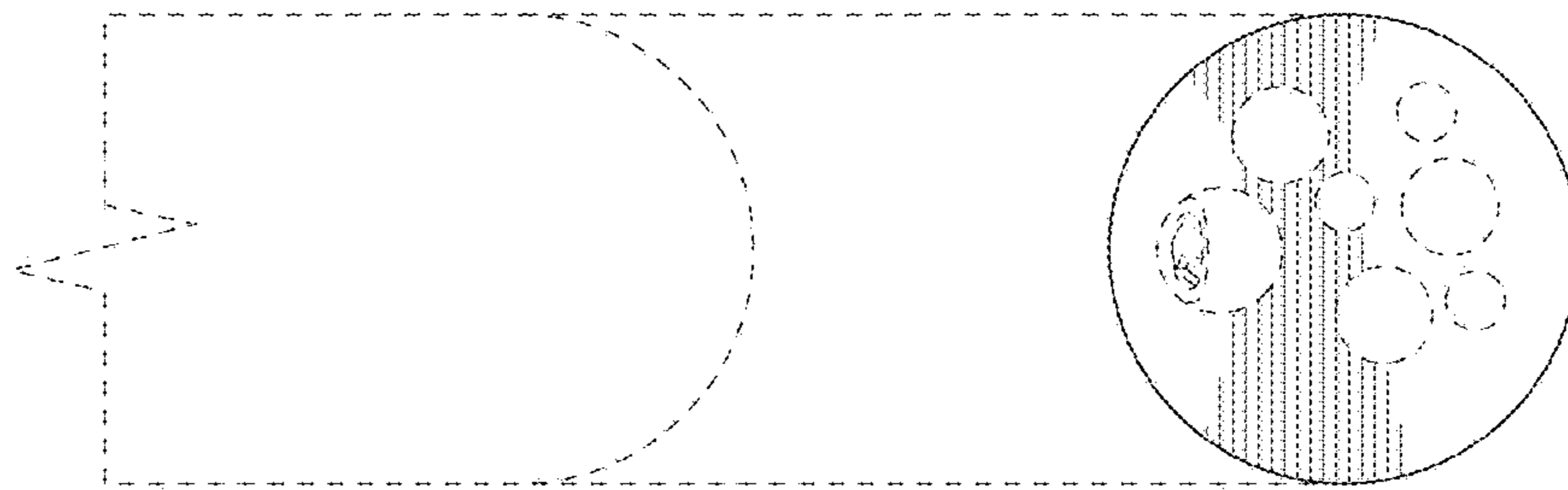

FIG. 6



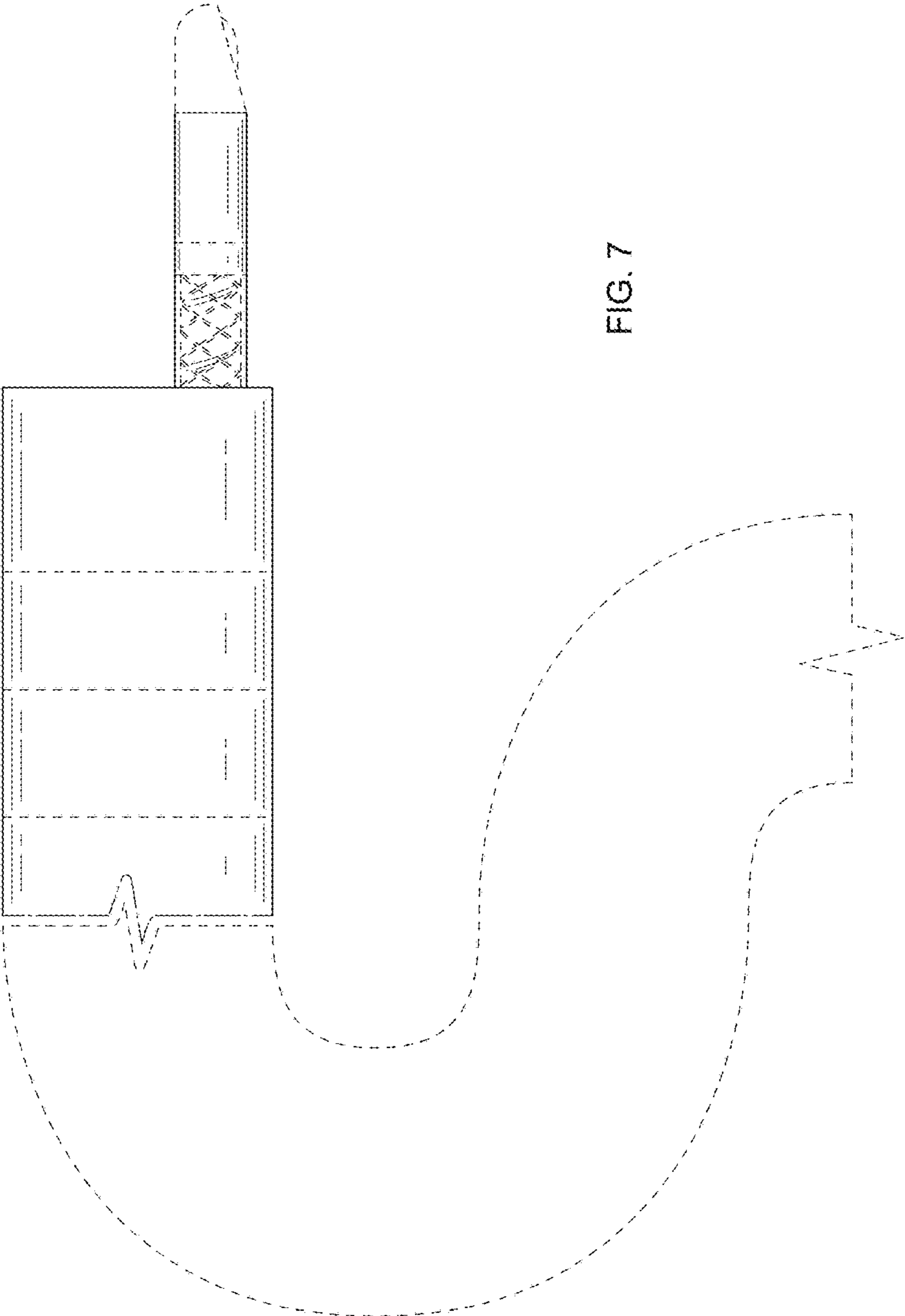

FIG. 7

