



US00D855715S

(12) **United States Design Patent**
Buonocore

(10) **Patent No.:** **US D855,715 S**

(45) **Date of Patent:** **** Aug. 6, 2019**

- (54) **PLUSH PENGUIN**
- (71) Applicant: **Ontel Products Corporation**, Fairfield, NJ (US)
- (72) Inventor: **Carly Buonocore**, Lincoln Park, NJ (US)
- (73) Assignee: **Ontel Products Corporation**, Fairfield, NJ (US)
- (**) Term: **15 Years**
- (21) Appl. No.: **29/679,236**

5,090,938	A *	2/1992	Reynolds	A63H 3/12 446/369
5,895,308	A *	4/1999	Spector	A63H 3/02 446/397
6,126,507	A *	10/2000	Lieberman	A63H 3/003 446/72
D441,411	S *	5/2001	Griswell	A63H 3/12 D21/630
D701,927	S *	4/2014	Van Der Erve	D21/576
D703,771	S *	4/2014	Carlson	D21/653
D706,368	S *	6/2014	Carlson	D21/653
D752,692	S *	3/2016	Arias Segui	D21/576
D770,325	S *	11/2016	Hu	D21/653
D773,557	S *	12/2016	Huang	D21/653
9,975,053	B1 *	5/2018	Sutton	A63H 3/12
2014/0237700	A1	8/2014	Albert		

- (22) Filed: **Feb. 4, 2019**
- (51) **LOC (12) Cl.** **21-01**
- (52) **U.S. Cl.**
USPC **D21/653**
- (58) **Field of Classification Search**
USPC D6/598; D11/158, 162; D21/576–596,
D21/604–608, 630, 653; 446/368–369,
446/376, 428, 487
CPC ... A63H 3/00; A63H 3/02; A63H 3/04; A63H
3/12; A63H 3/16; A63H 3/28; A63H
33/00; A63H 11/00; A63H 11/10; A63H
11/20; A63H 13/00; A63H 33/04; A63H
33/08
See application file for complete search history.

* cited by examiner

Primary Examiner — Sandra L Morris
(74) *Attorney, Agent, or Firm* — John S. Artz; Dickinson Wright PLLC

- (56) **References Cited**
U.S. PATENT DOCUMENTS
D282,193 S * 1/1986 Sasaki A63H 3/12
D21/653
D287,611 S * 1/1987 Sato D21/653

(57) **CLAIM**
I claim the ornamental design for a plush penguin, as shown and described.

DESCRIPTION
FIG. 1 is a front perspective view of a plush penguin; FIG. 2 is a front view of the plush penguin of FIG. 1; FIG. 3 is a rear view of the plush penguin of FIG. 1; FIG. 4 is a right side view of the plush penguin of FIG. 1; FIG. 5 is a left side view of the plush penguin of FIG. 1; FIG. 6 is a top view of the plush penguin of FIG. 1; and, FIG. 7 is a bottom view of the plush penguin of FIG. 1. The broken lines in the drawings illustrate portions of the plush penguin that form no part of the claimed design.

1 Claim, 4 Drawing Sheets

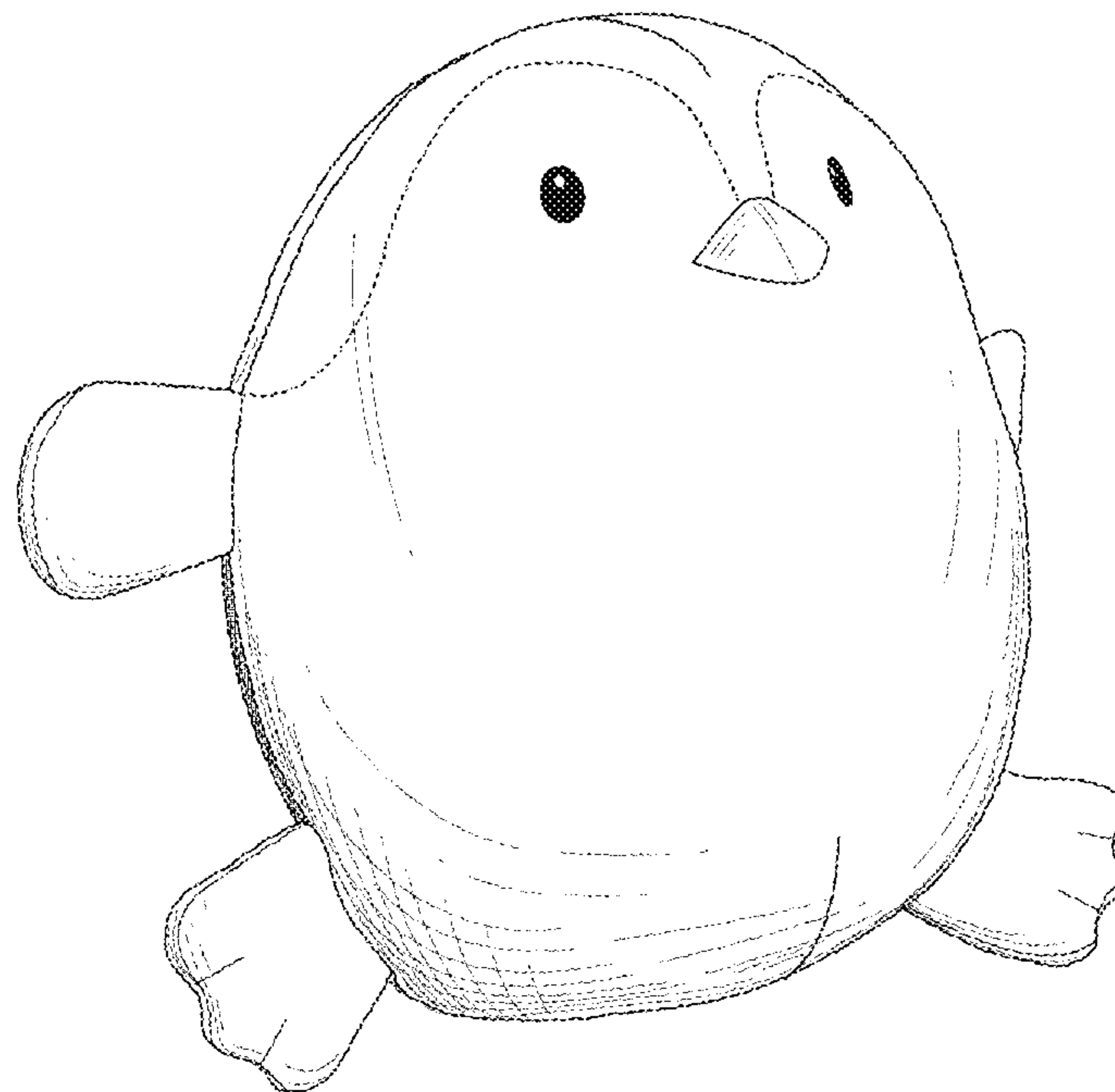

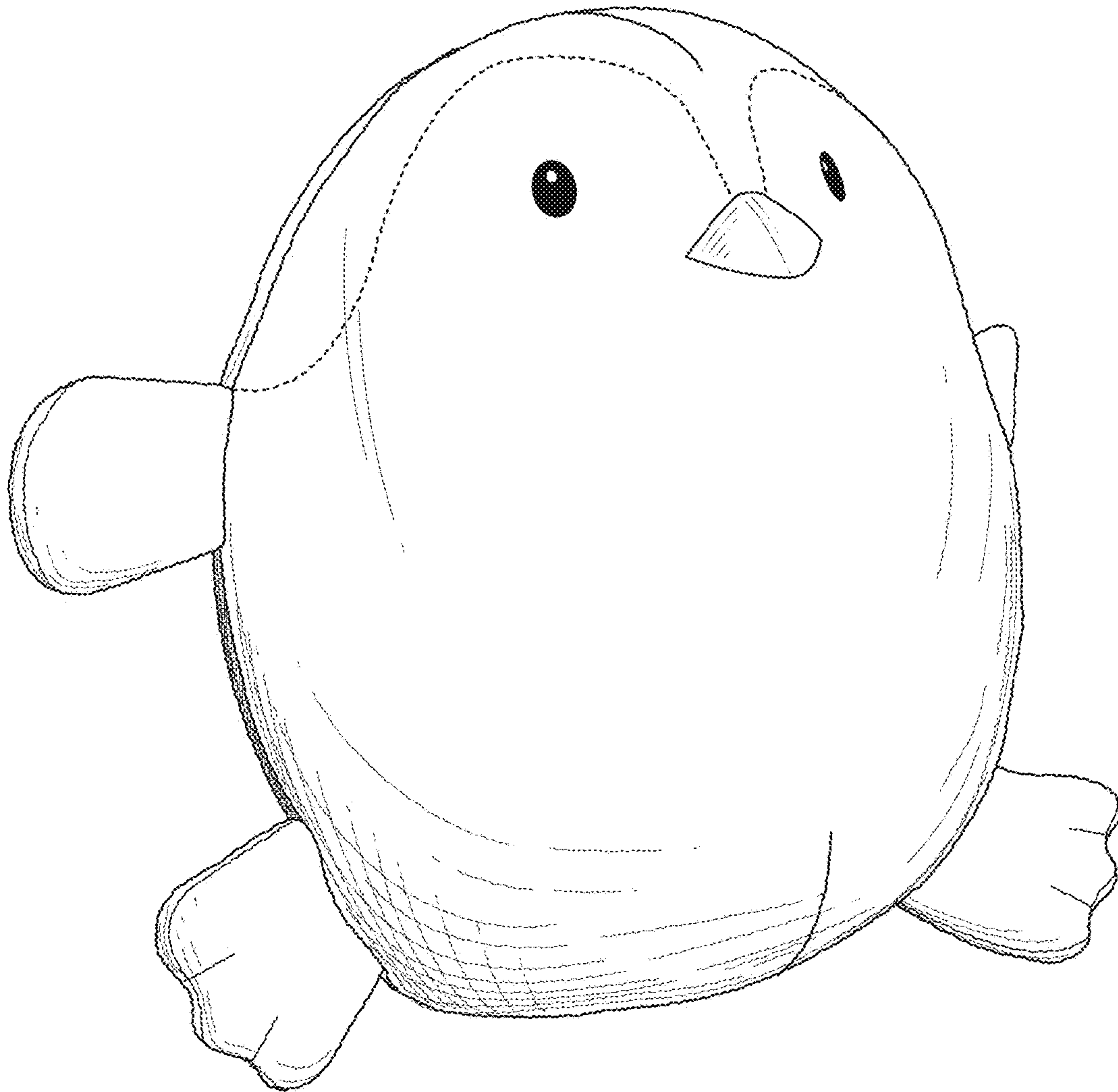

FIG. 1

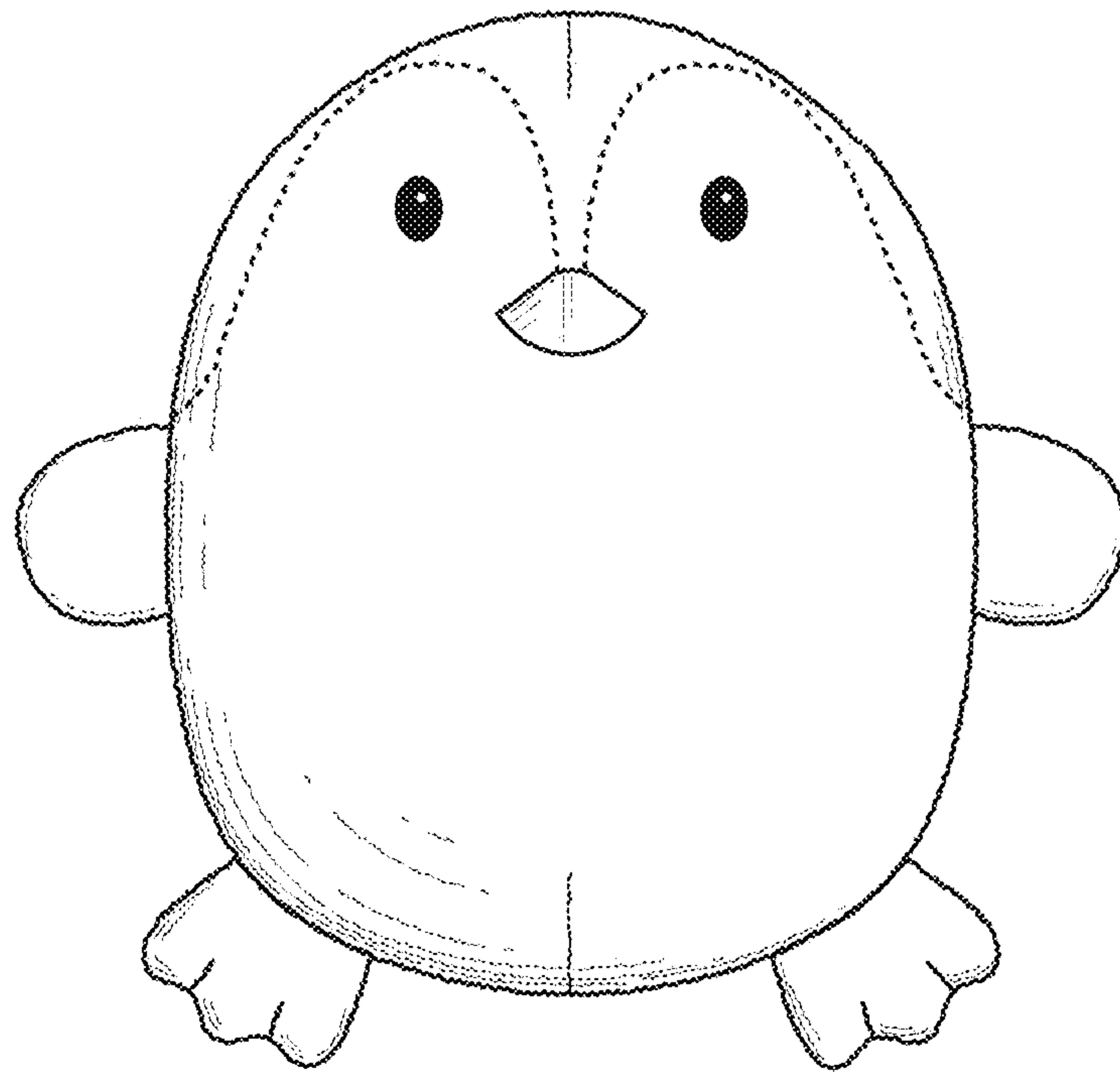

FIG. 2

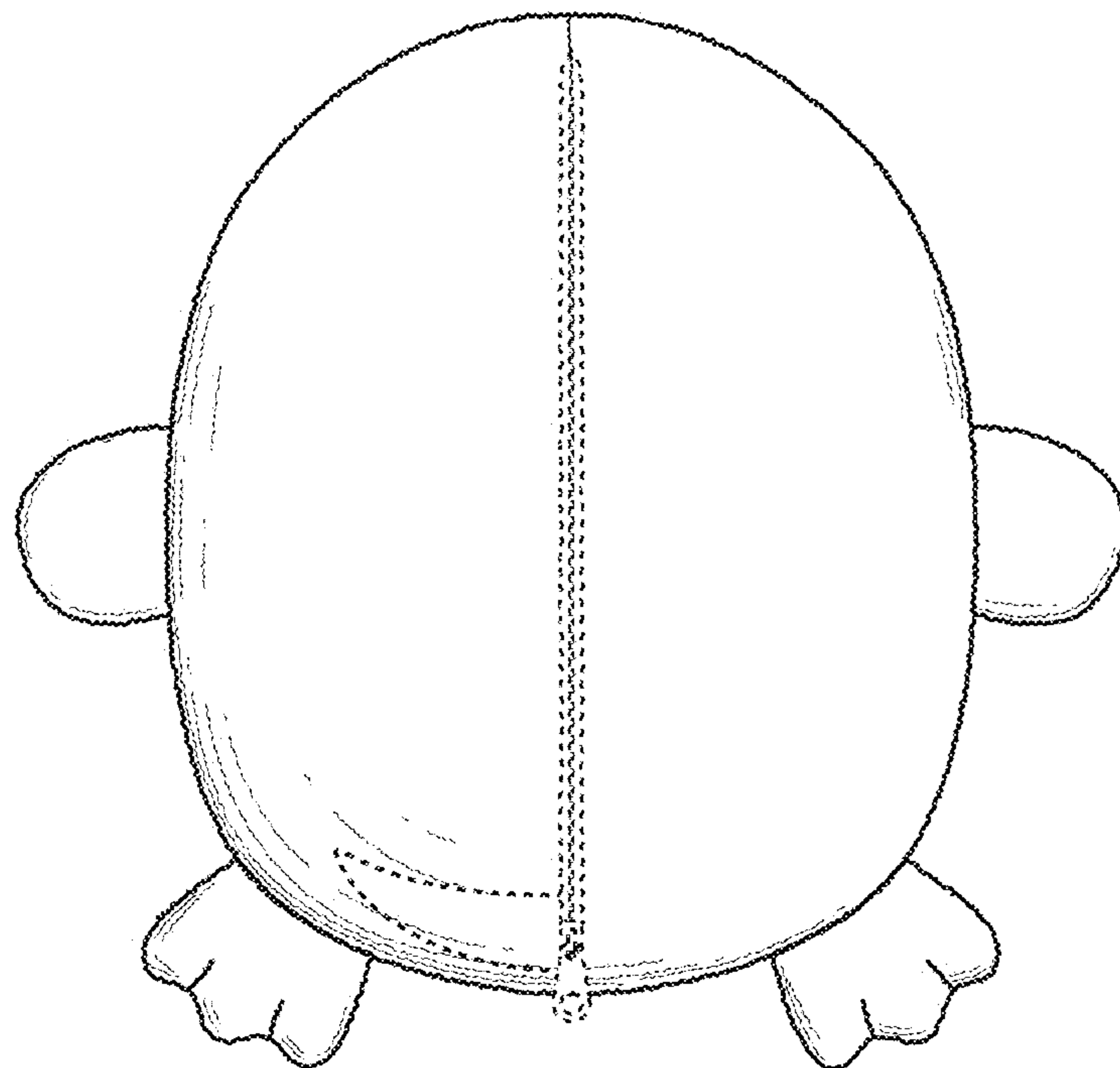

FIG. 3

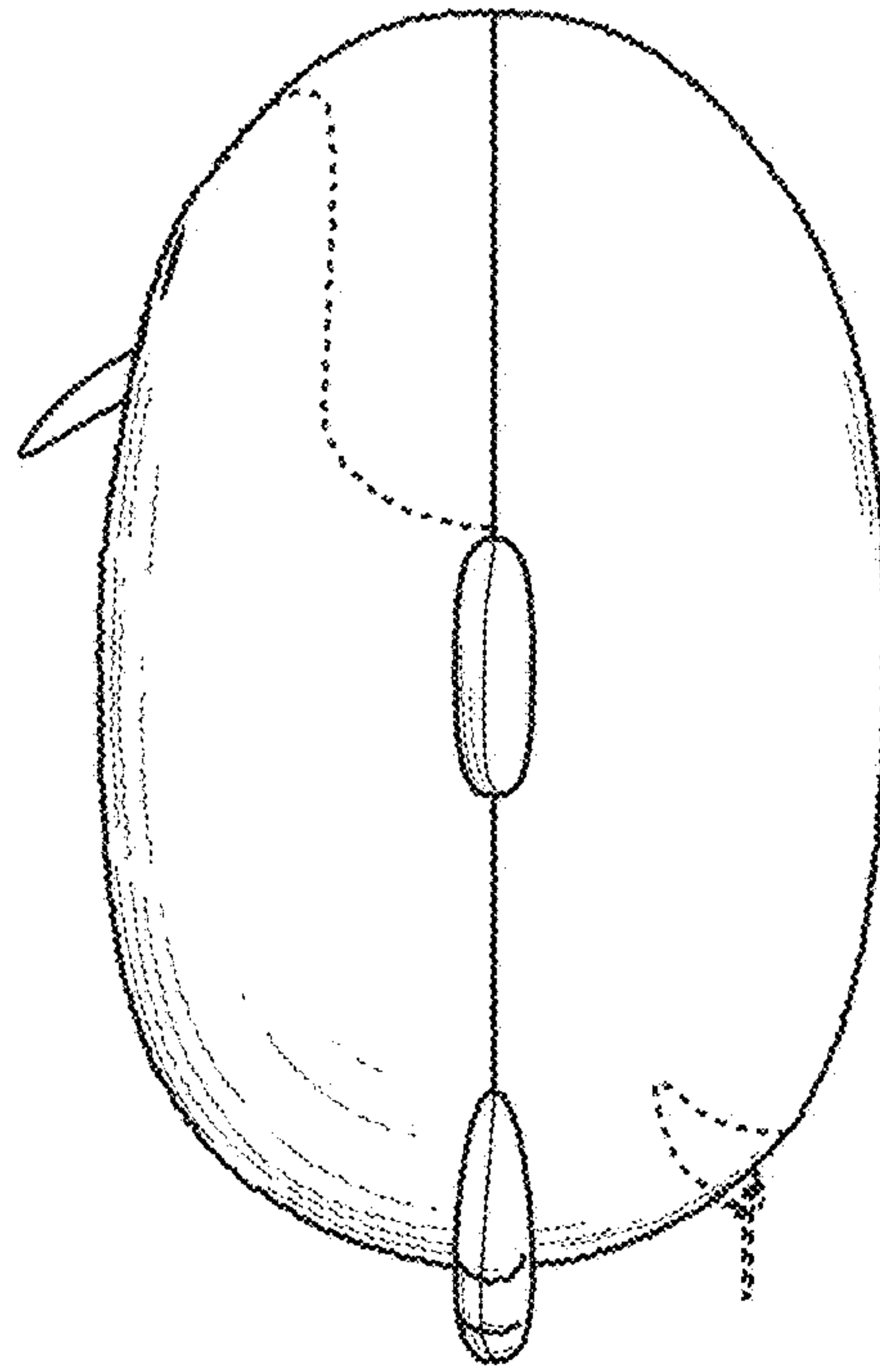

FIG. 4

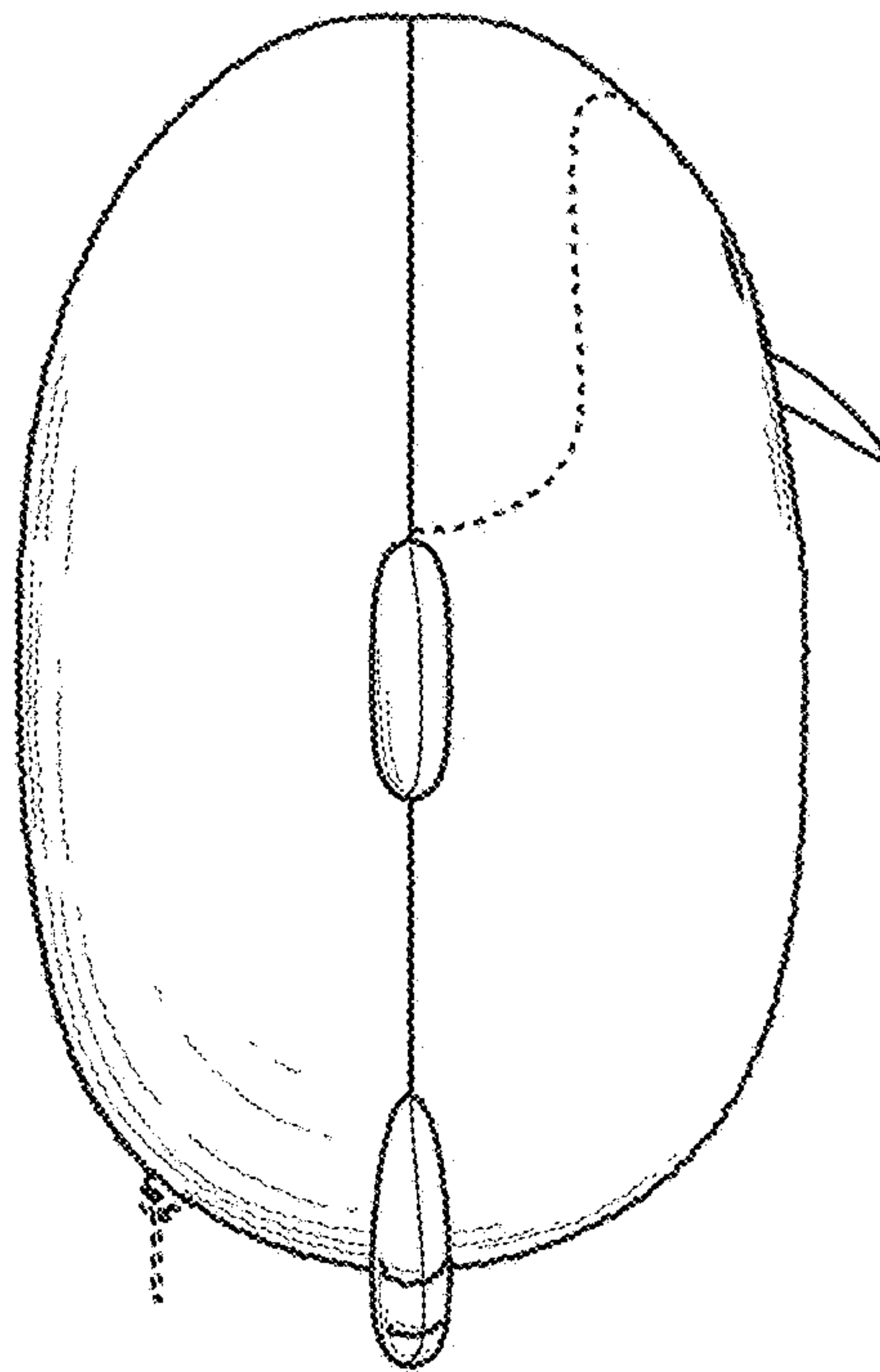

FIG. 5

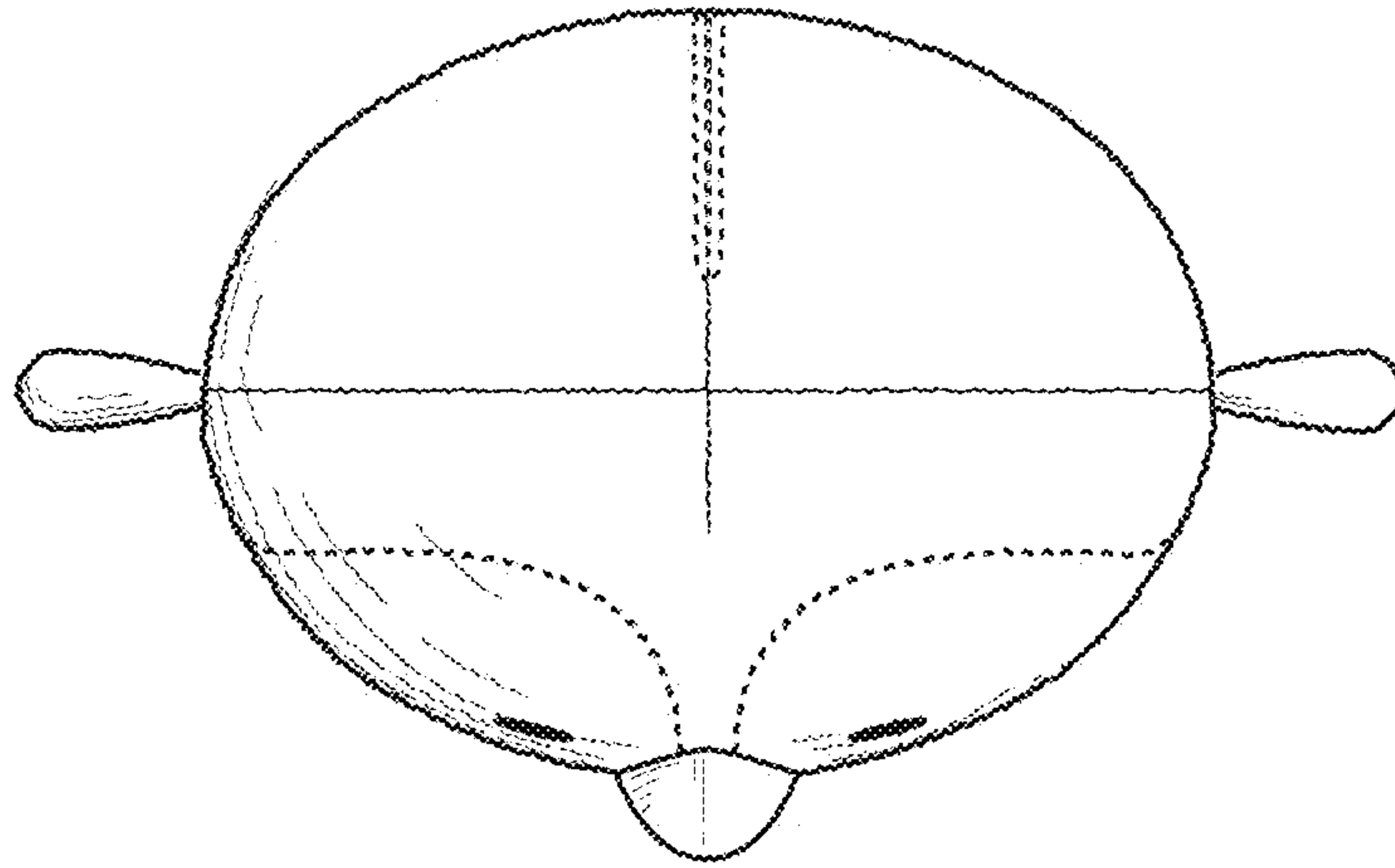

FIG. 6

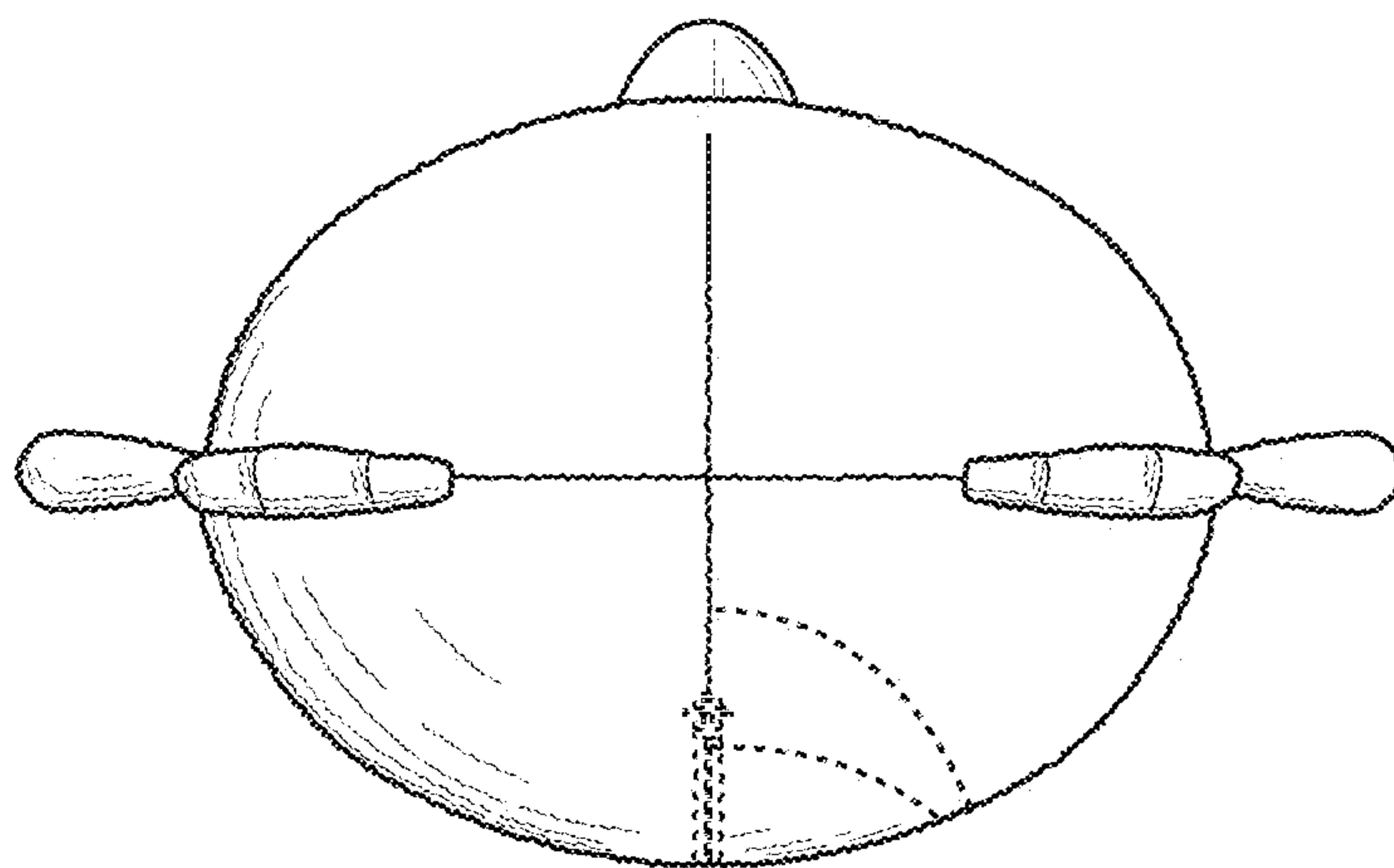

FIG. 7