



US00D855593S

(12) **United States Design Patent** (10) **Patent No.:** **US D855,593 S**
Seong et al. (45) **Date of Patent:** **** Aug. 6, 2019**

(54) **TELEVISION RECEIVER**

FOREIGN PATENT DOCUMENTS

(71) Applicant: **Samsung Electronics Co., Ltd.**,
Suwon-si (KR)

CN 2014302682129 2/2015
CN 2014303725494 2/2015

(Continued)

(72) Inventors: **Bo-Kyung Seong**, Daejeon-Si (KR);
Sung-Jin Ann, Seoul (KR); **Gil-Jae Lee**, Seoul (KR); **Won-Chul Hwang**,
Seoul (KR)

Primary Examiner — Brett Miller
(74) *Attorney, Agent, or Firm* — NSIP Law

(73) Assignee: **Samsung Electronics Co., Ltd.**,
Suwon-si (KR)

(57) **CLAIM**

We claim the ornamental design for a television receiver, as shown and described.

(**) Term: **15 Years**

DESCRIPTION

(21) Appl. No.: **29/638,255**

(22) Filed: **Feb. 26, 2018**

(30) **Foreign Application Priority Data**

Sep. 1, 2017 (KR) 30-2017-0040925

(51) **LOC (12) Cl.** **14-03**

(52) **U.S. Cl.**
USPC **D14/239**

(58) **Field of Classification Search**
USPC D14/371, 373-377, 382, 451, 126, 239,
D14/125, 127, 129; D6/708, 708.16, 300,
D6/308, 310-313, 691.6; D8/349, 354,
D8/363, 373, 376, 380, 315, 319, 320,
D8/307

CPC G06F 1/1601; H04N 5/64; H04N 5/655;
H05K 5/0017; H05K 5/0234

See application file for complete search history.

(56) **References Cited**

U.S. PATENT DOCUMENTS

D670,257 S * 11/2012 Yang D14/126
D671,540 S * 11/2012 Yukawa D14/336
D700,187 S * 2/2014 Lee D14/451

(Continued)

FIG. 1 is a front perspective view of a television receiver showing our new design;
FIG. 2 is a front view thereof;
FIG. 3 is a rear view thereof;
FIG. 4 is a left-side view thereof;
FIG. 5 is a right-side view thereof;
FIG. 6 is a top view thereof;
FIG. 7 is a bottom view thereof;
FIG. 8 is a rear perspective view thereof;
FIG. 9 is an enlarged view of the encircled portion in FIG. 6;
FIG. 10 is a front perspective view of the stand portion of the television receiver;
FIG. 11 is a front view thereof;
FIG. 12 is a rear view thereof;
FIG. 13 is a left-side view thereof;
FIG. 14 is a right-side view thereof;
FIG. 15 is a top view thereof;
FIG. 16 is a bottom view thereof; and,
FIG. 17 is a rear perspective view thereof.
The broken lines in the figures depict portions of the television receiver which form no part of the claimed design. The dot-dash broken lines encircling portions of the claimed design that are illustrated in enlargements form no part of the claimed design.

1 Claim, 17 Drawing Sheets

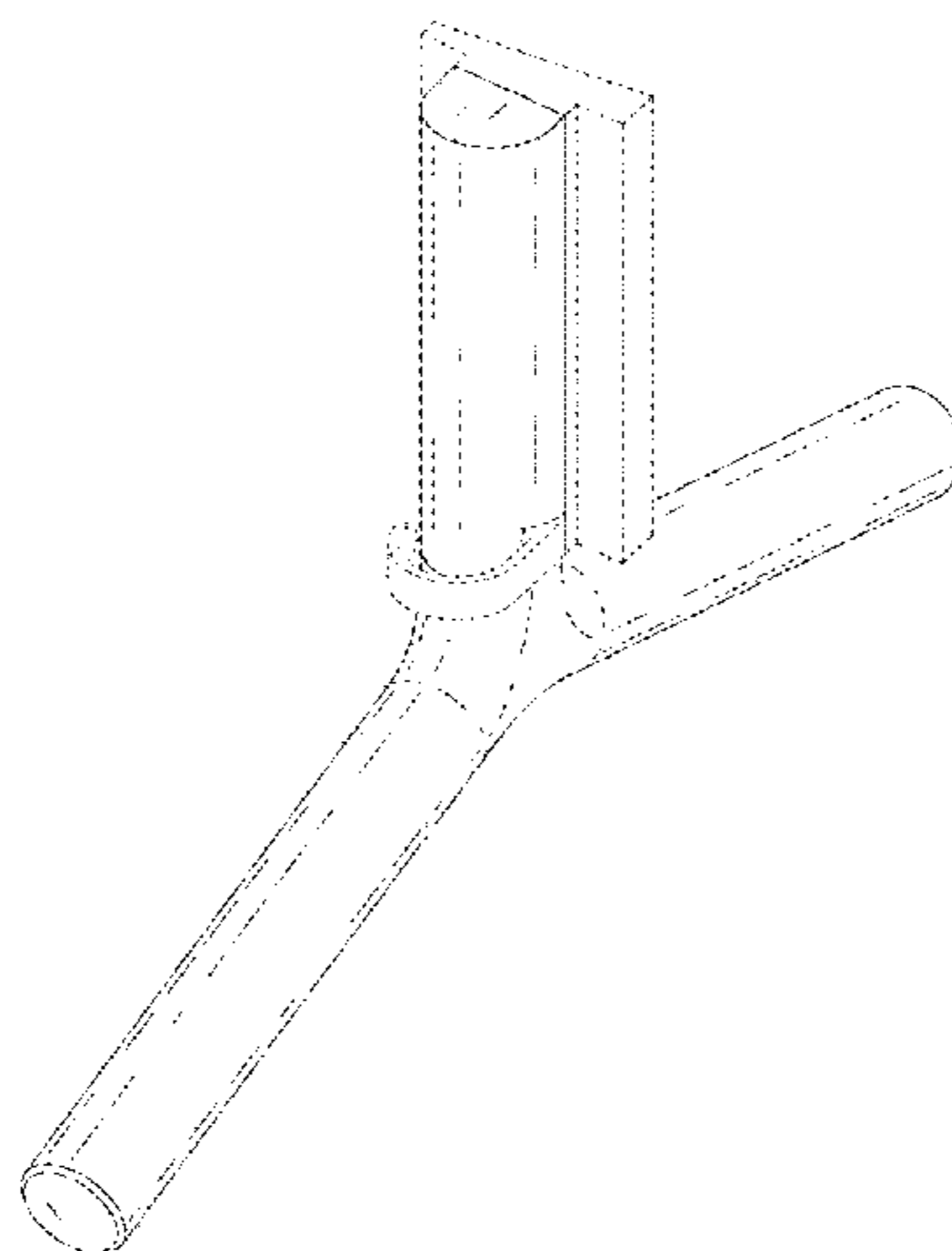

(56)

References Cited

U.S. PATENT DOCUMENTS

D705,200	S	*	5/2014	Choi	D14/239
D723,486	S	*	3/2015	Lee	D14/126
D725,661	S	*	3/2015	Snyder	D14/451
D742,364	S	*	11/2015	Reinhertz	D14/239
D746,825	S	*	1/2016	Kang	D14/451
D761,238	S	*	7/2016	Ann	D14/239
D772,684	S	*	11/2016	Zimmer	D8/307
D787,296	S	*	5/2017	Zimmer	D8/307
D787,462	S	*	5/2017	Shiono	D14/126
D808,940	S	*	1/2018	Debaigue	D14/239
D817,902	S	*	5/2018	Lee	D14/126
D818,999	S	*	5/2018	Kim	D14/239
D821,370	S	*	6/2018	Kim	D14/239
D822,670	S	*	7/2018	Hubert	D14/451
D823,824	S	*	7/2018	Won	D14/126
D824,889	S	*	8/2018	Debaigue	D14/239
D827,601	S	*	9/2018	Kim	D14/126
2010/0309618	A1	*	12/2010	Park	F16M 11/10 361/679.01

FOREIGN PATENT DOCUMENTS

CN	2014304429286	5/2015
EM	003105154-0001	10/2016
WO	DM/090 908	5/2016

* cited by examiner

FIG. 1

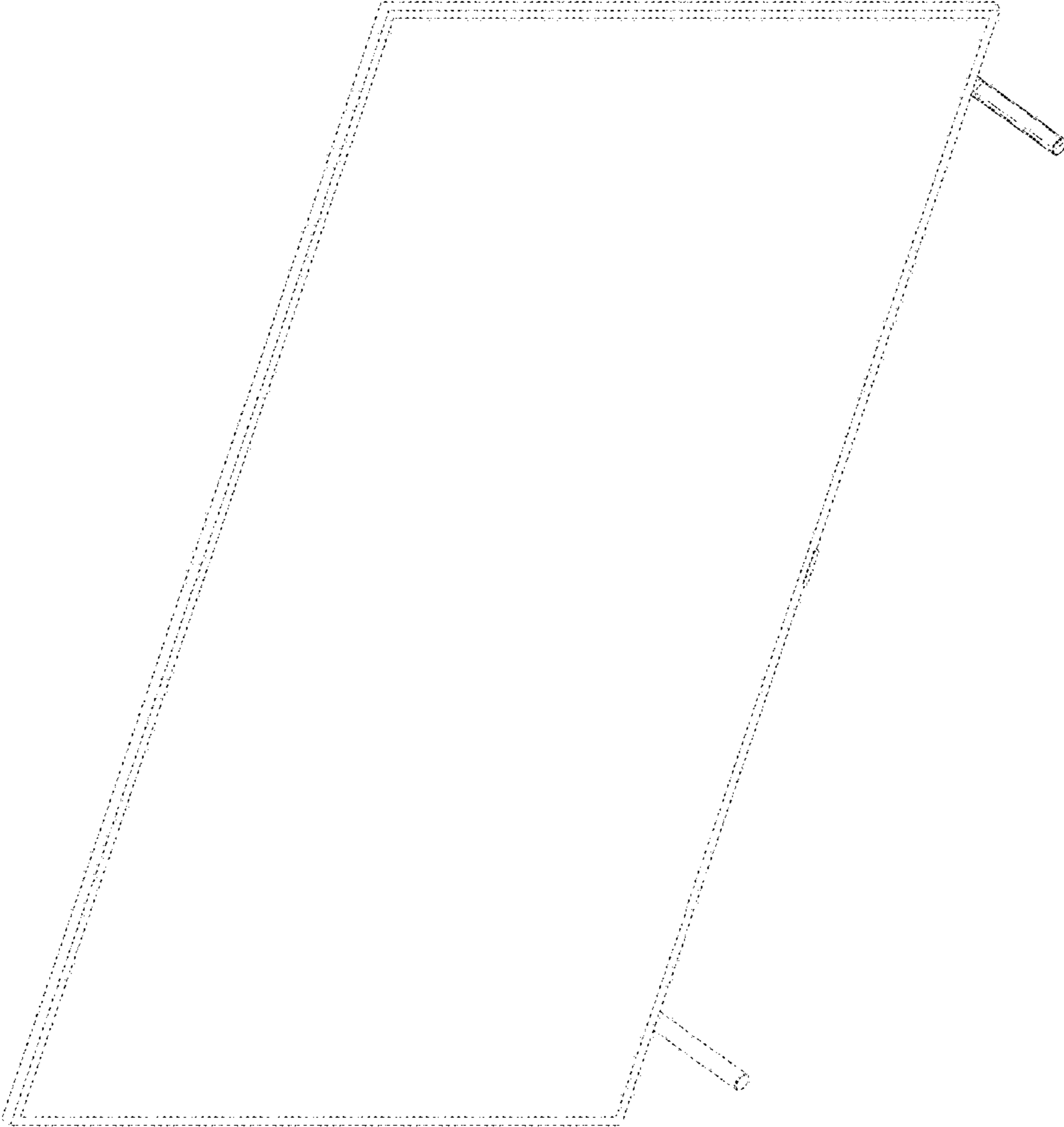

FIG. 2

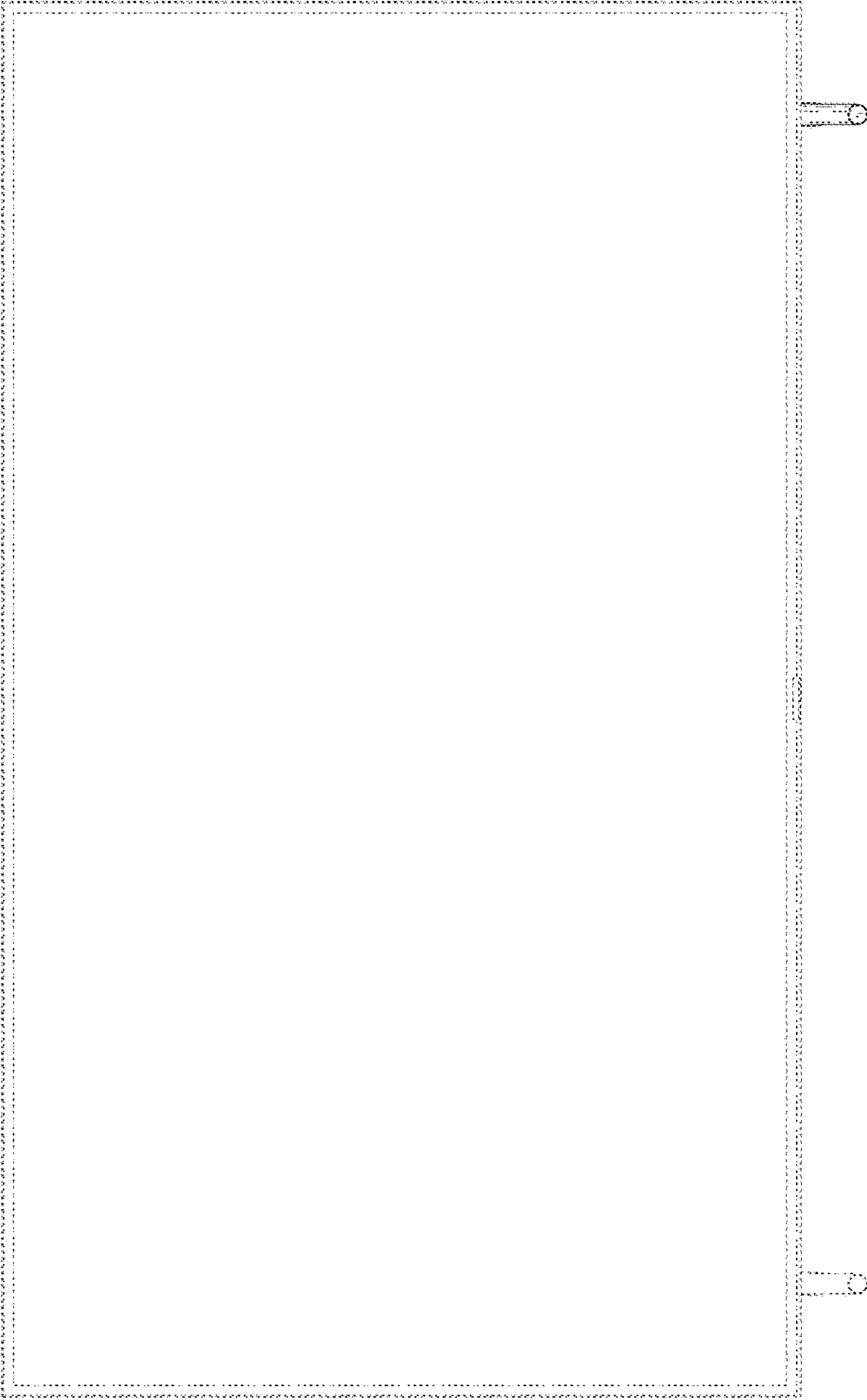

FIG. 3

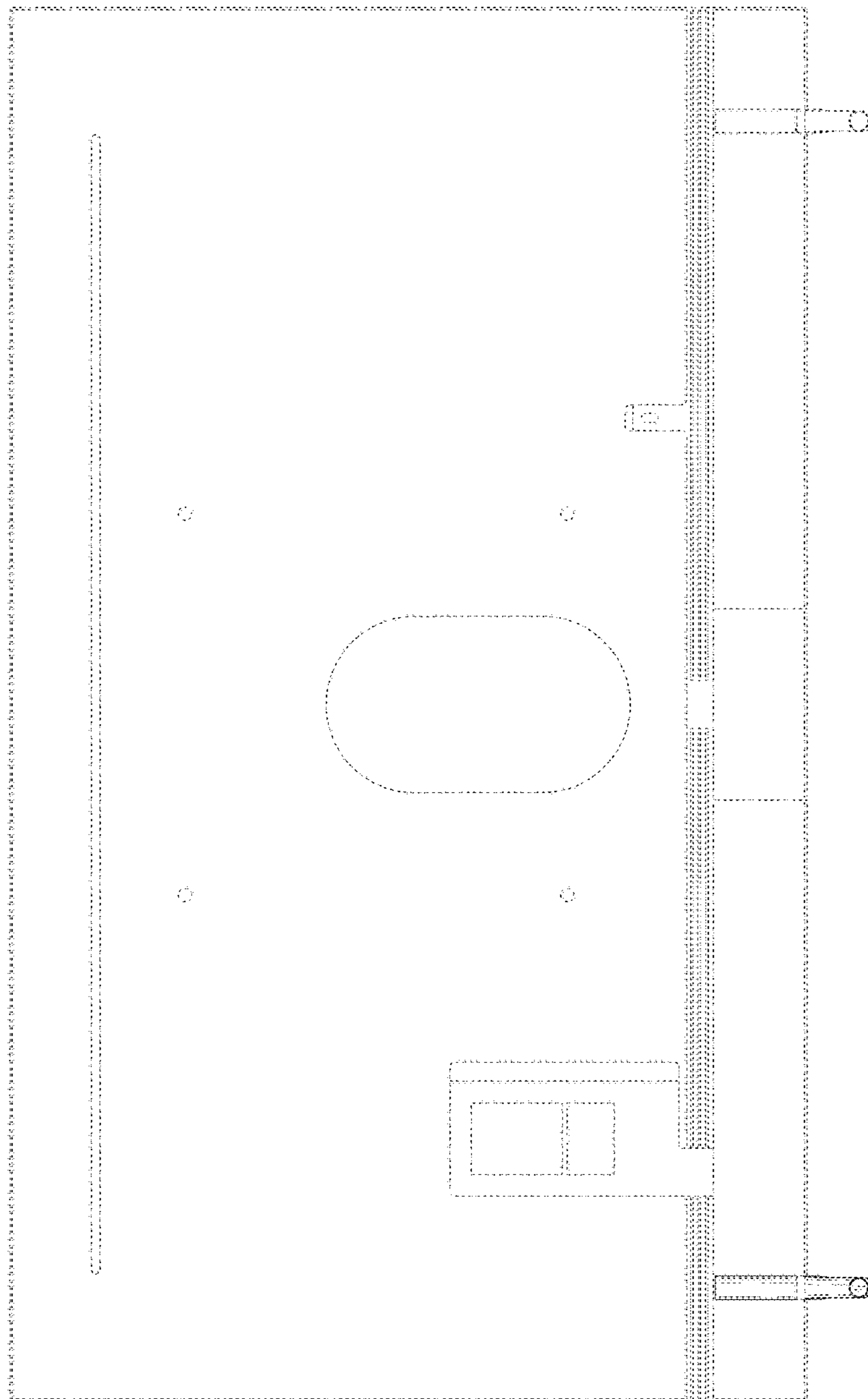

FIG. 4

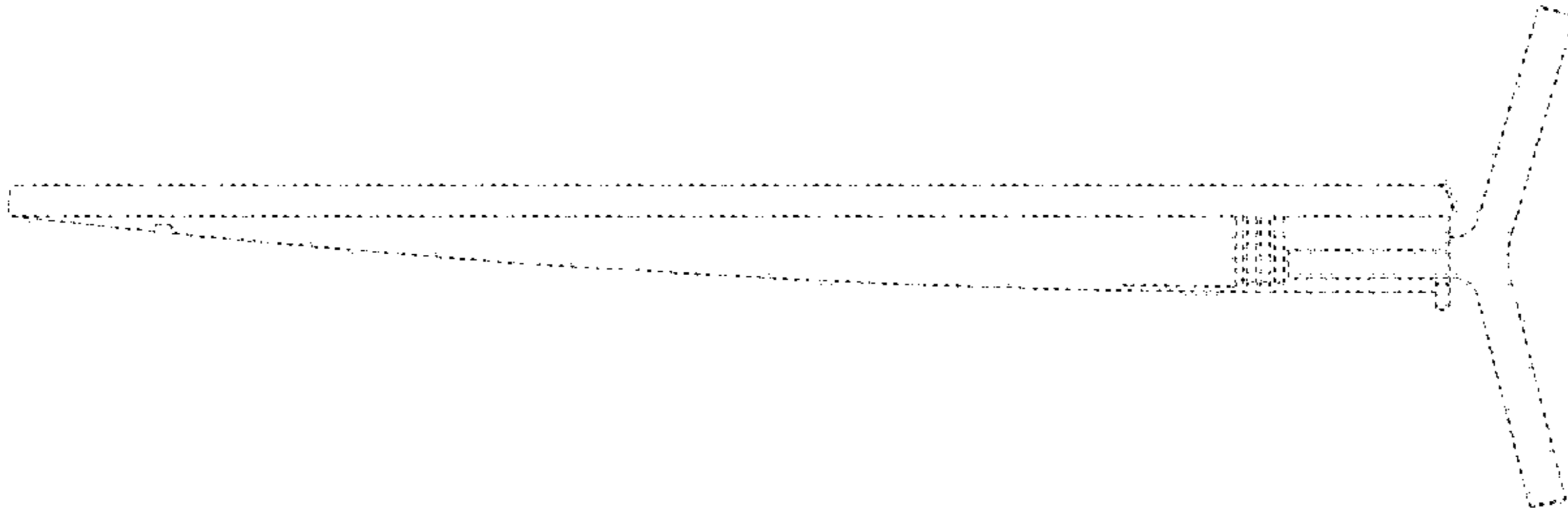

FIG. 5

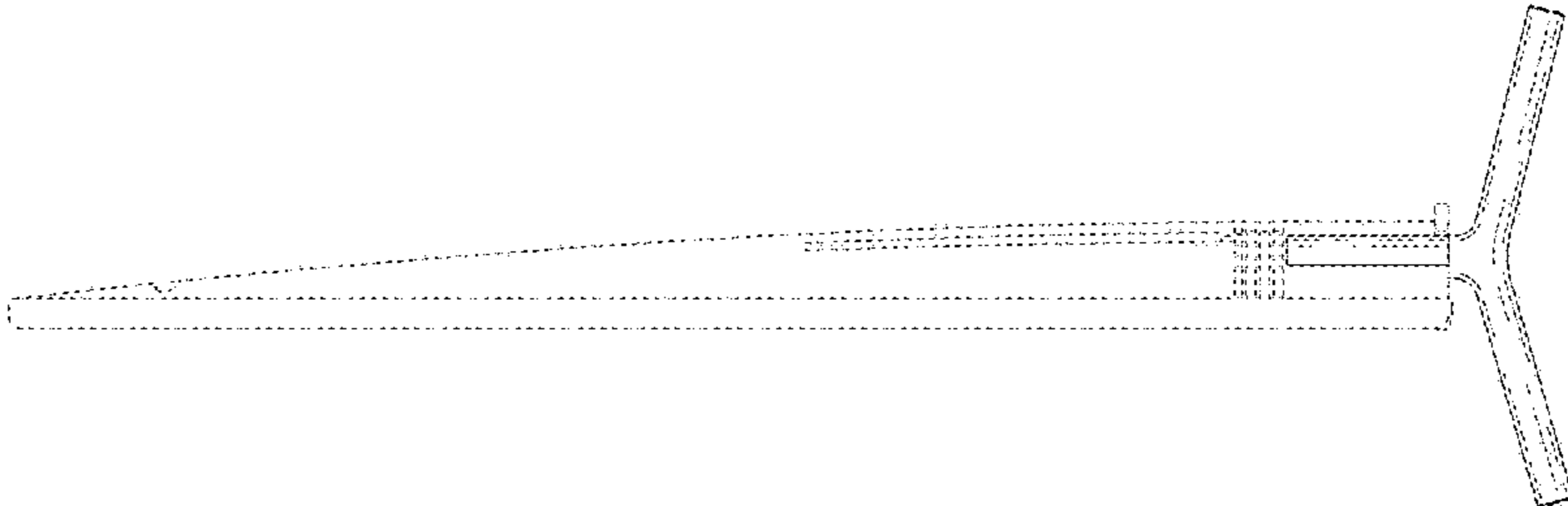

FIG. 6

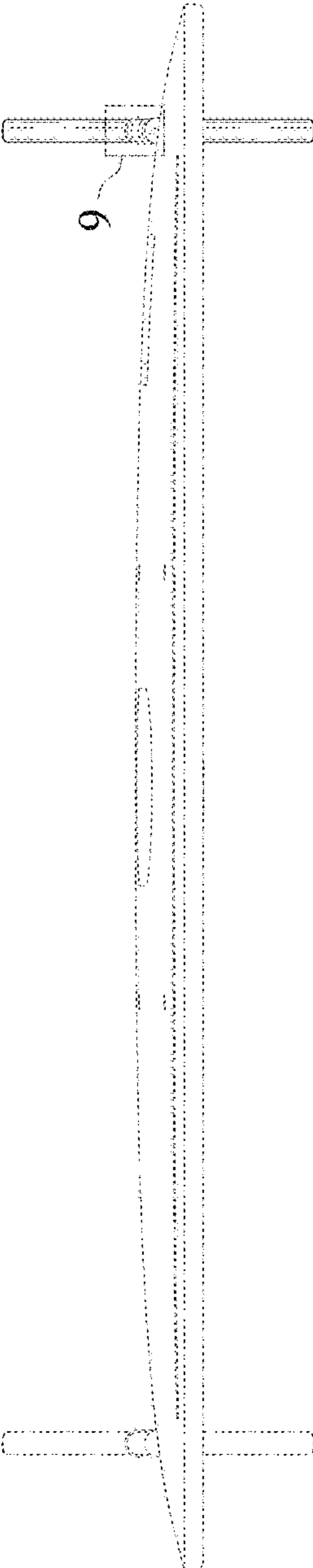

FIG. 7

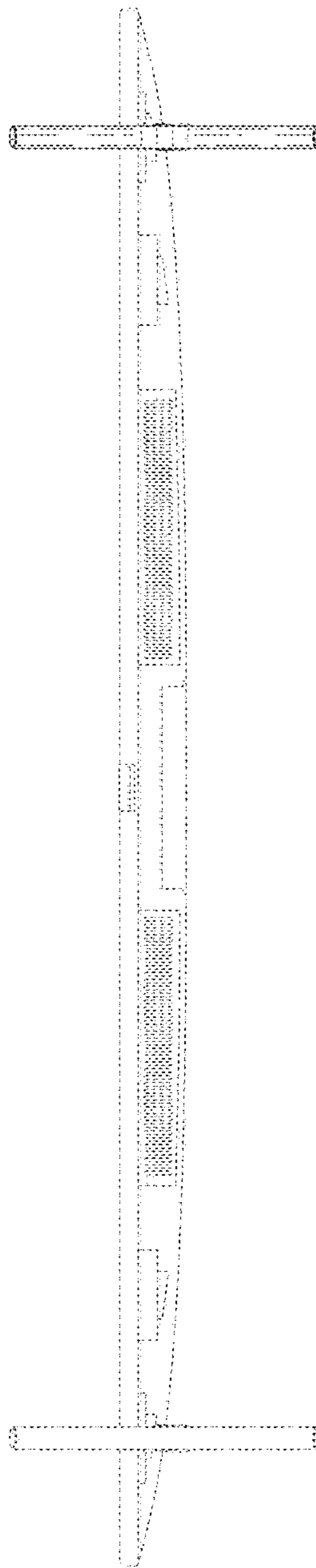

FIG. 8

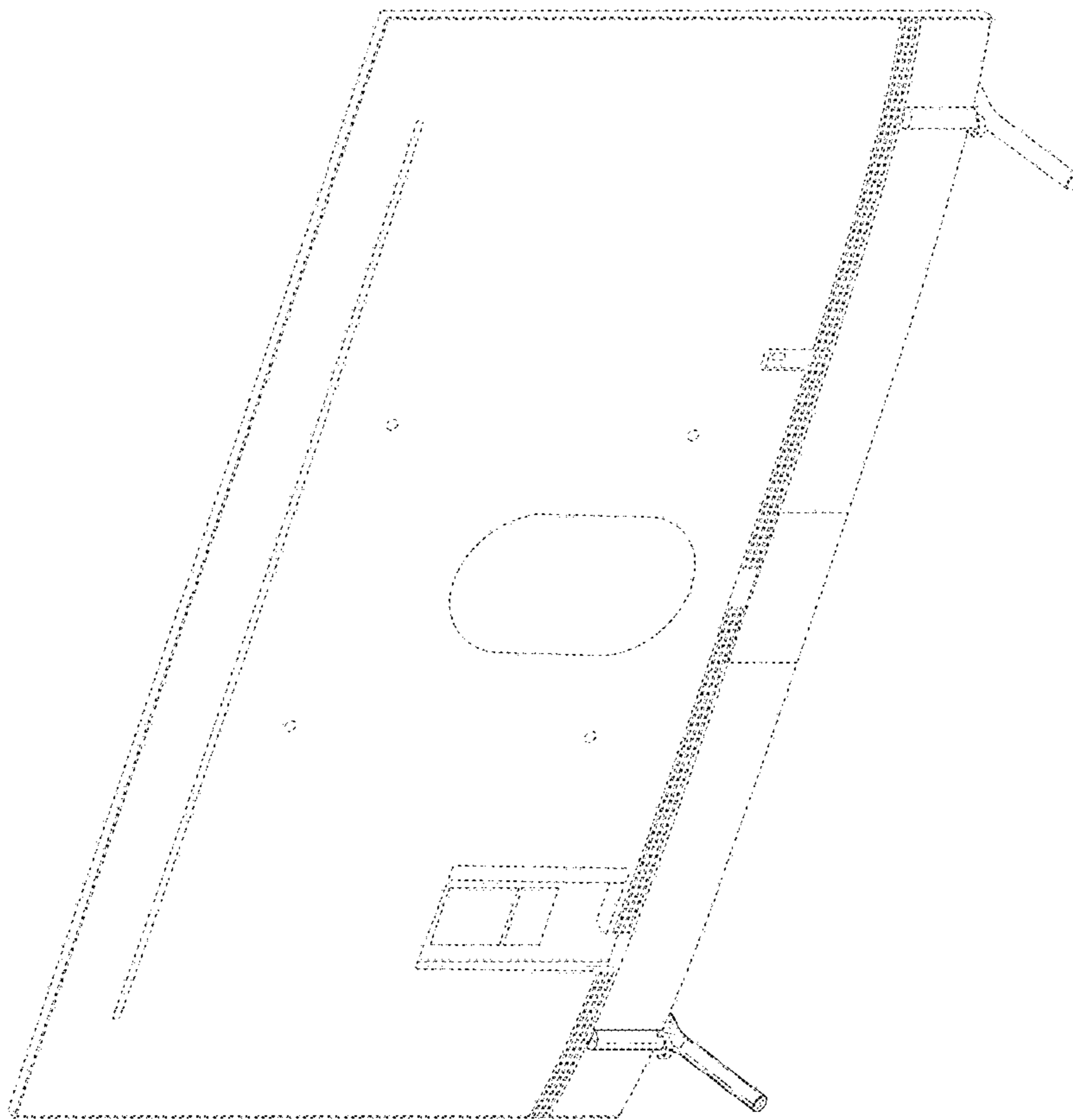

FIG. 9

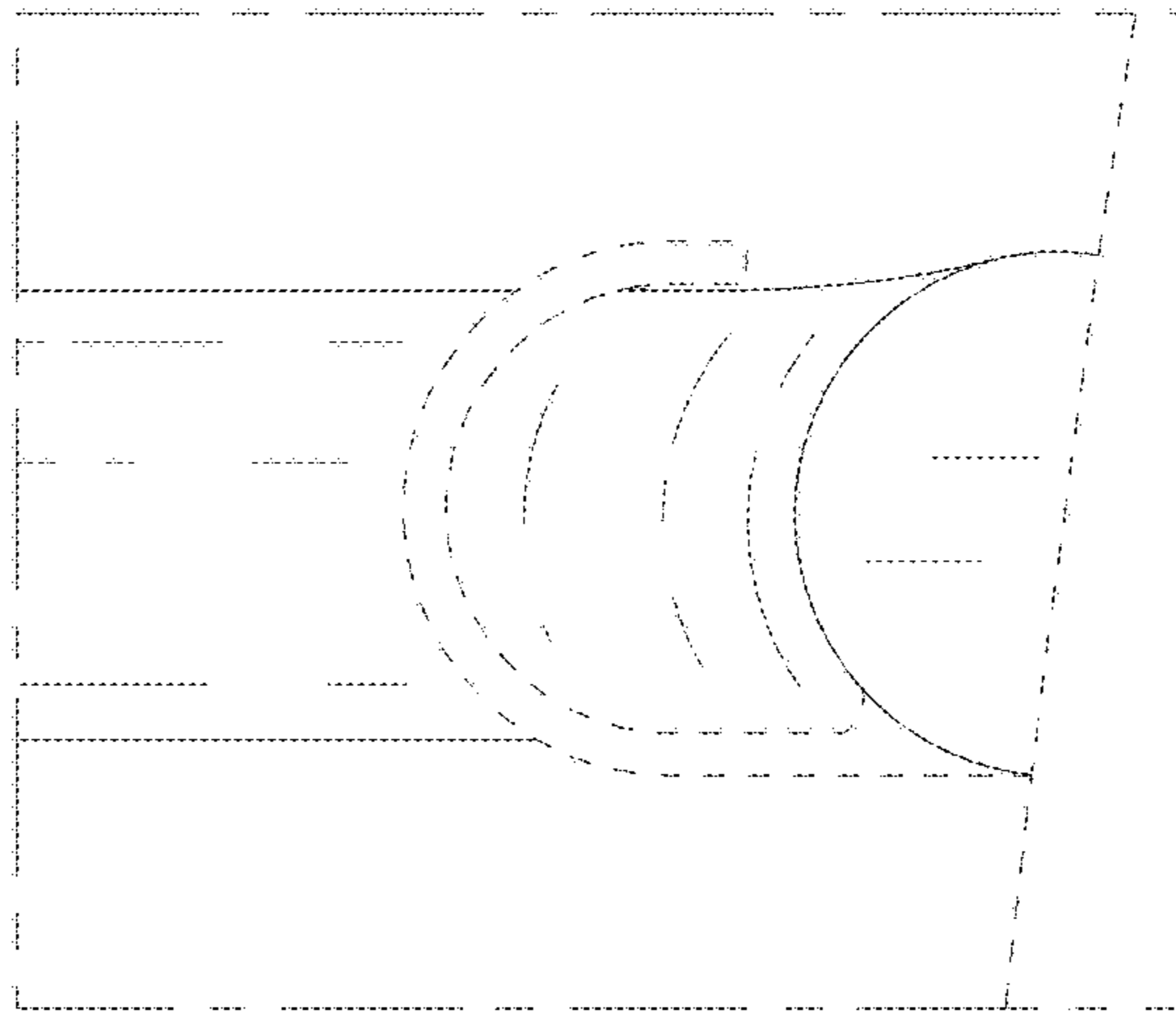

FIG. 10

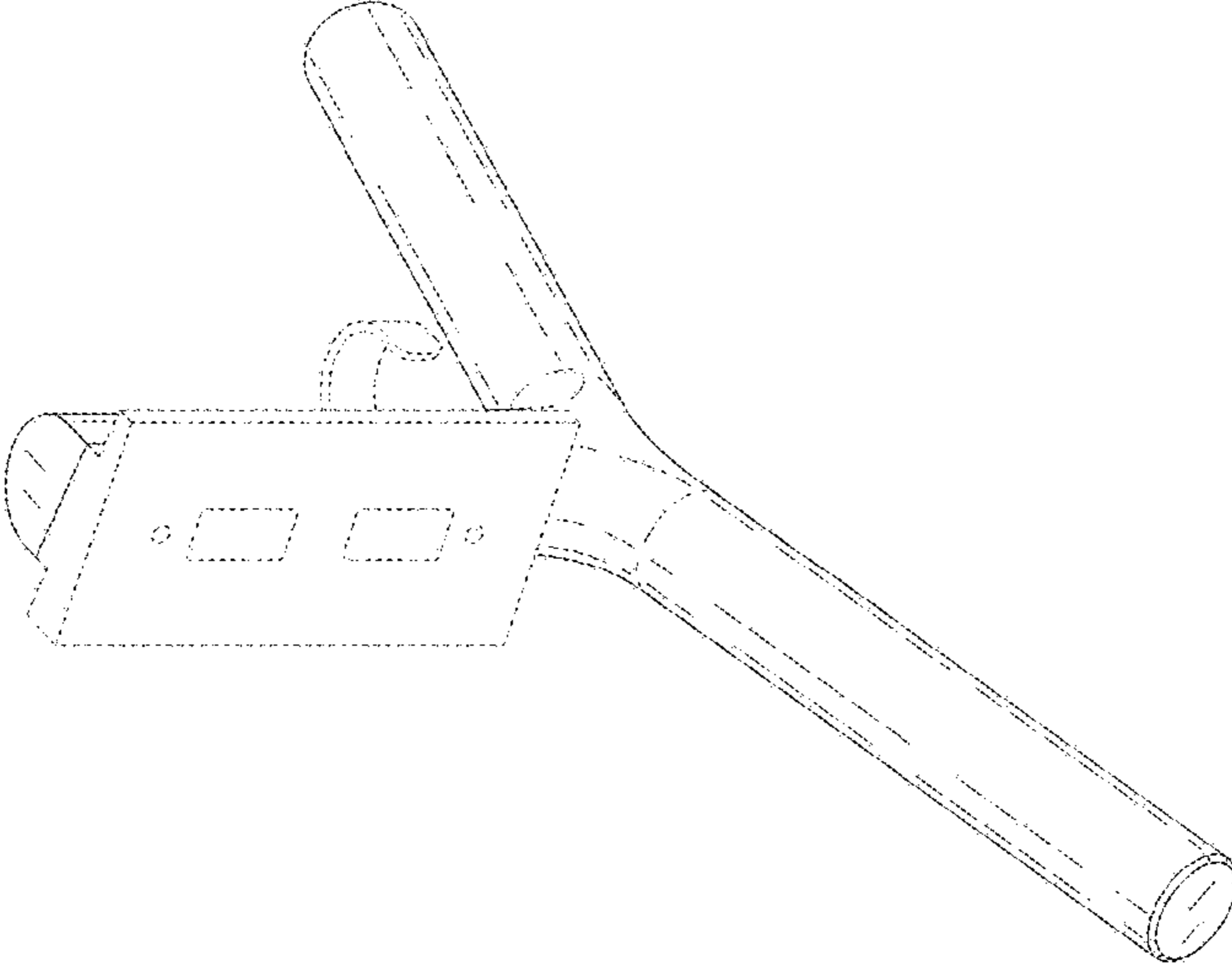

FIG. 11

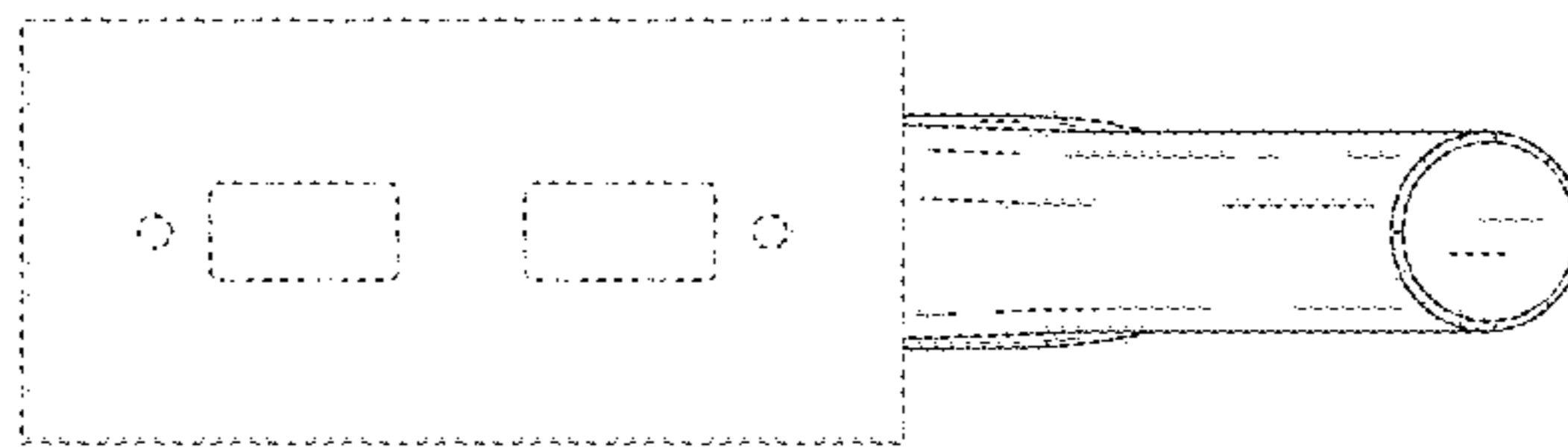

FIG. 12

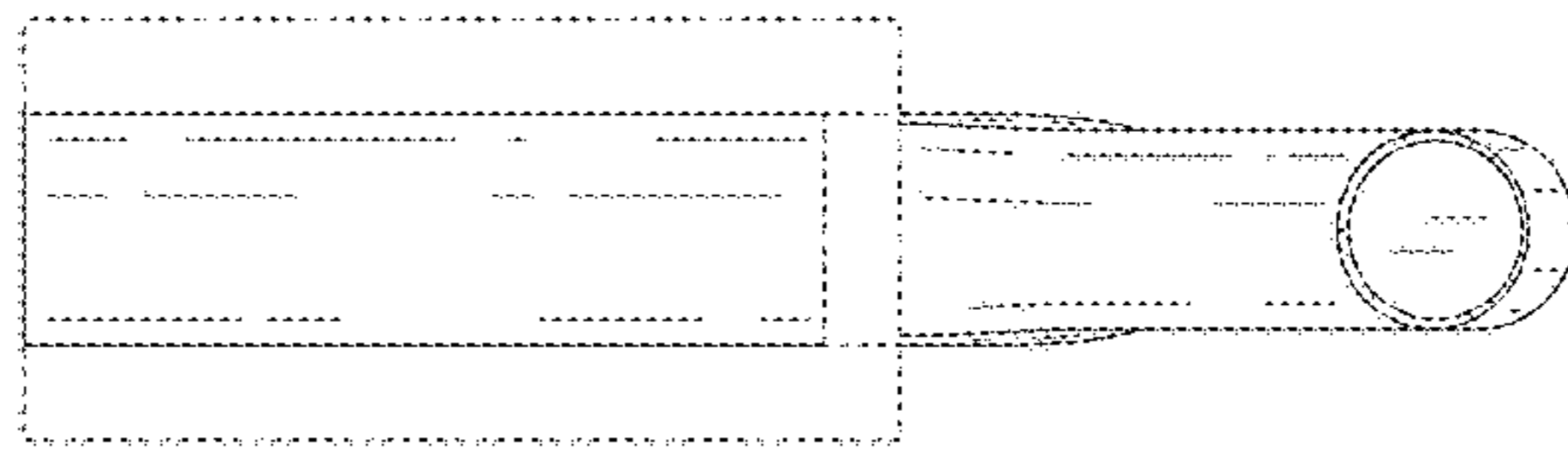

FIG. 13

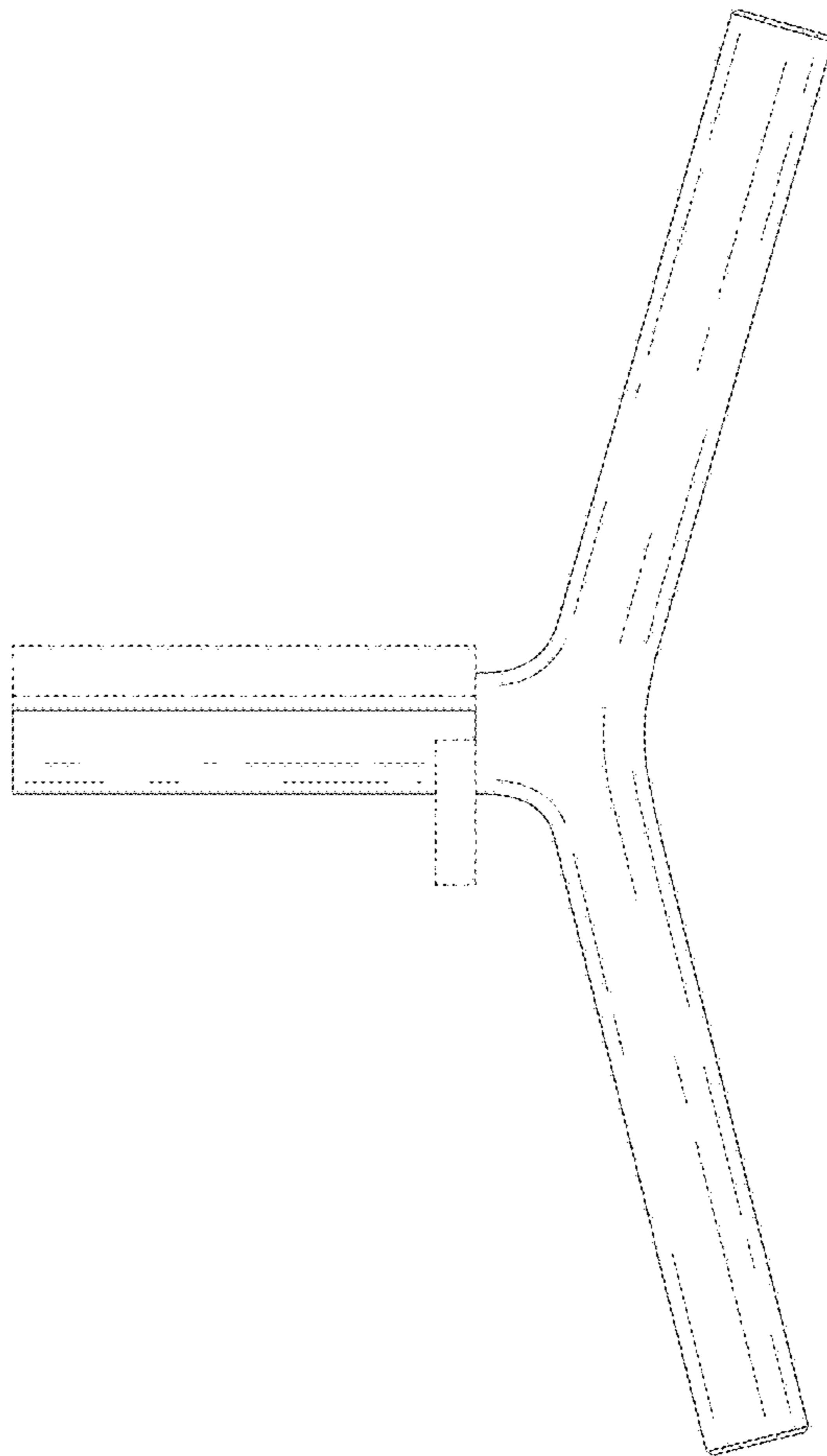
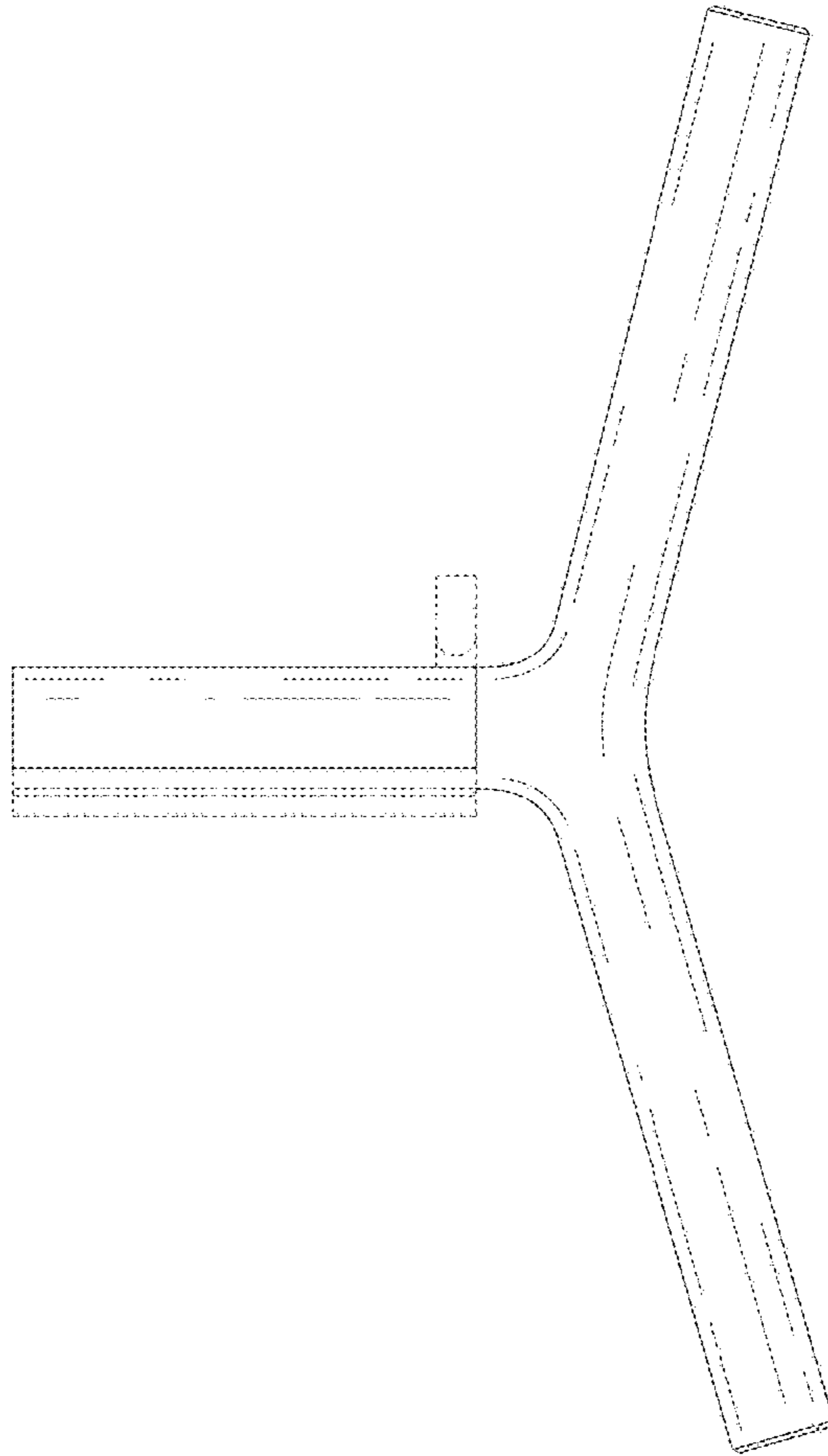
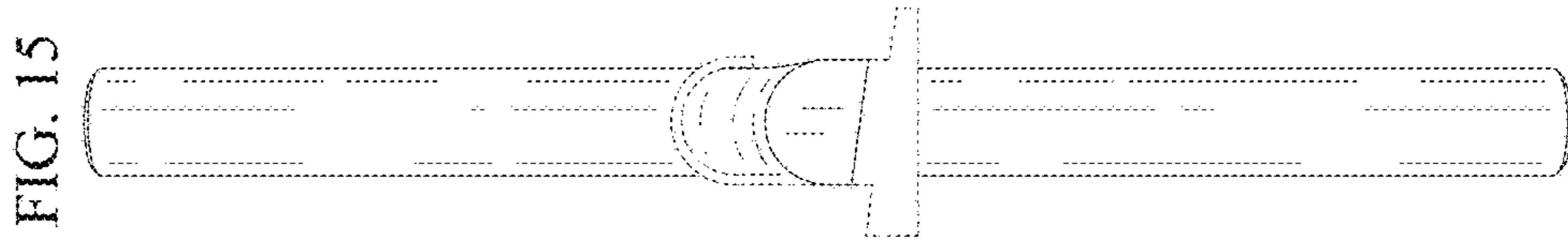

FIG. 14





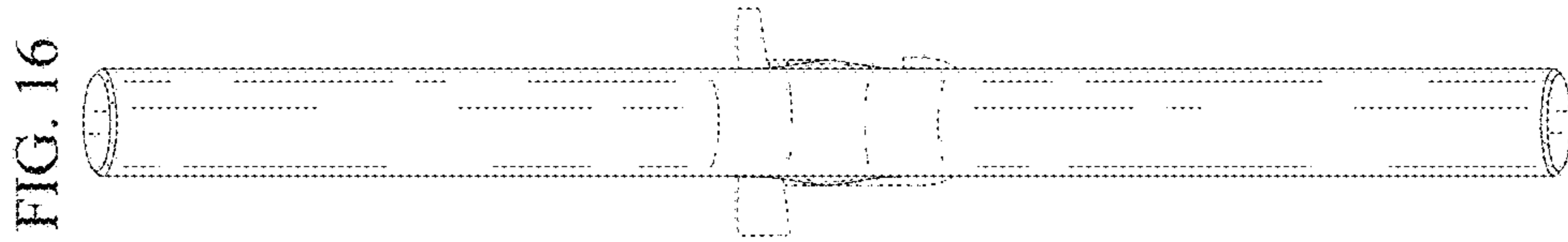

FIG. 17

