



US00D855589S

(12) **United States Design Patent** (10) **Patent No.:** **US D855,589 S**
Madsen (45) **Date of Patent:** **** Aug. 6, 2019**

(54) **EARPHONES**
(71) Applicant: **LIZN APS**, Vejle Øst (DK)
(72) Inventor: **Torben Madsen**, Aarhus C (DK)
(**) Term: **15 Years**

D783,578 S * 4/2017 Bristol D14/223
D786,221 S * 5/2017 Stoch D14/223
D787,480 S * 5/2017 Morris D14/223
D789,911 S * 6/2017 Katopis D14/223
D808,934 S * 1/2018 Tang D14/223
D813,206 S * 3/2018 Tang D14/223
D816,637 S * 5/2018 Hardi D14/205

* cited by examiner

(21) Appl. No.: **35/504,011**
(22) Filed: **Aug. 30, 2017**

Primary Examiner — Melanie H Tung
Assistant Examiner — Bao-Yen T Nguyen

(80) **Hague Agreement Data**
Int. Filing Date: **Aug. 30, 2017**
Int. Reg. No.: **DM/098412**
Int. Reg. Date: **Aug. 30, 2017**
Int. Reg. Pub. Date: **Nov. 24, 2017**

(57) **CLAIM**

The ornamental design for an earphone, as shown and described.

(51) **LOC (12) Cl.** **14-01**
(52) **U.S. Cl.**
USPC **D14/223**
(58) **Field of Classification Search**
USPC D14/205, 206, 223
CPC H04R 1/10; H04R 1/1016; H04R 1/1066;
H04R 1/105; H04R 1/1033; H04R 1/08;
H04R 5/033; H04R 5/0335; H04R 25/00
See application file for complete search history.

DESCRIPTION

FIG. 1.1 is a perspective view of an earphone, showing my new design;
FIG. 1.2 is a front view thereof;
FIG. 1.3 is a right side view thereof;
FIG. 1.4 is a back view thereof;
FIG. 1.5 is a left side view thereof;
FIG. 1.6 is a top view thereof;
FIG. 1.7 is a bottom view thereof;
FIG. 2.1 is a perspective view thereof in another embodiment;
FIG. 2.2 is a front view thereof;
FIG. 2.3 is a right side view thereof;
FIG. 2.4 is a back view thereof;
FIG. 2.5 is a left side view thereof;
FIG. 2.6 is a top view thereof; and
FIG. 2.7 is a bottom view thereof;
In the reproductions, the broken lines illustrate portions of the earphones and form no part of the claimed design.

(56) **References Cited**
U.S. PATENT DOCUMENTS

D618,209 S * 6/2010 Andre D14/205
D618,210 S * 6/2010 Andre D14/205
D647,081 S * 10/2011 Kwon D14/223
D700,905 S * 3/2014 Pavitsich D14/223
D752,542 S * 3/2016 Lamar D14/205
D781,822 S * 3/2017 Morris D14/223

1 Claim, 14 Drawing Sheets

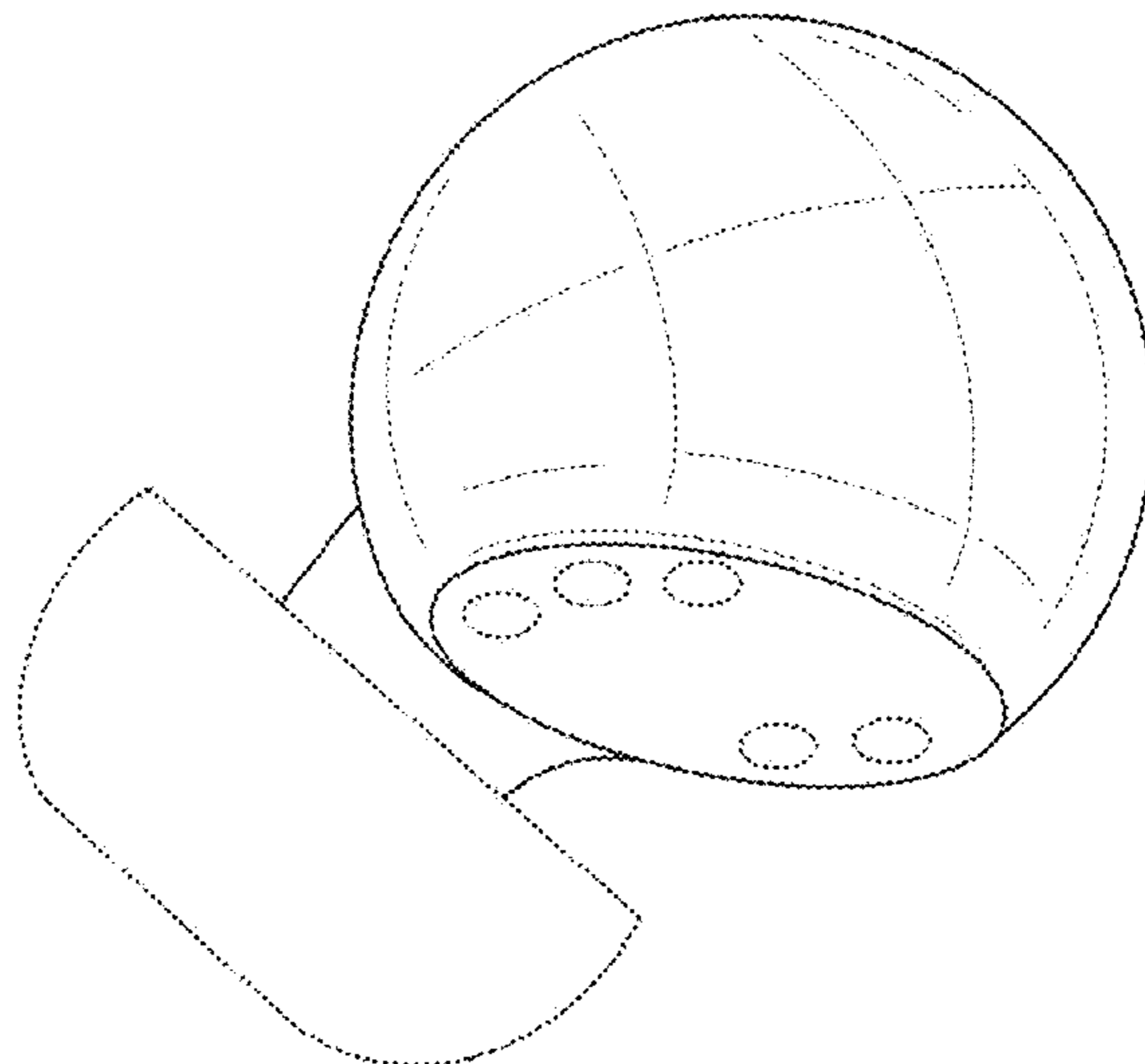

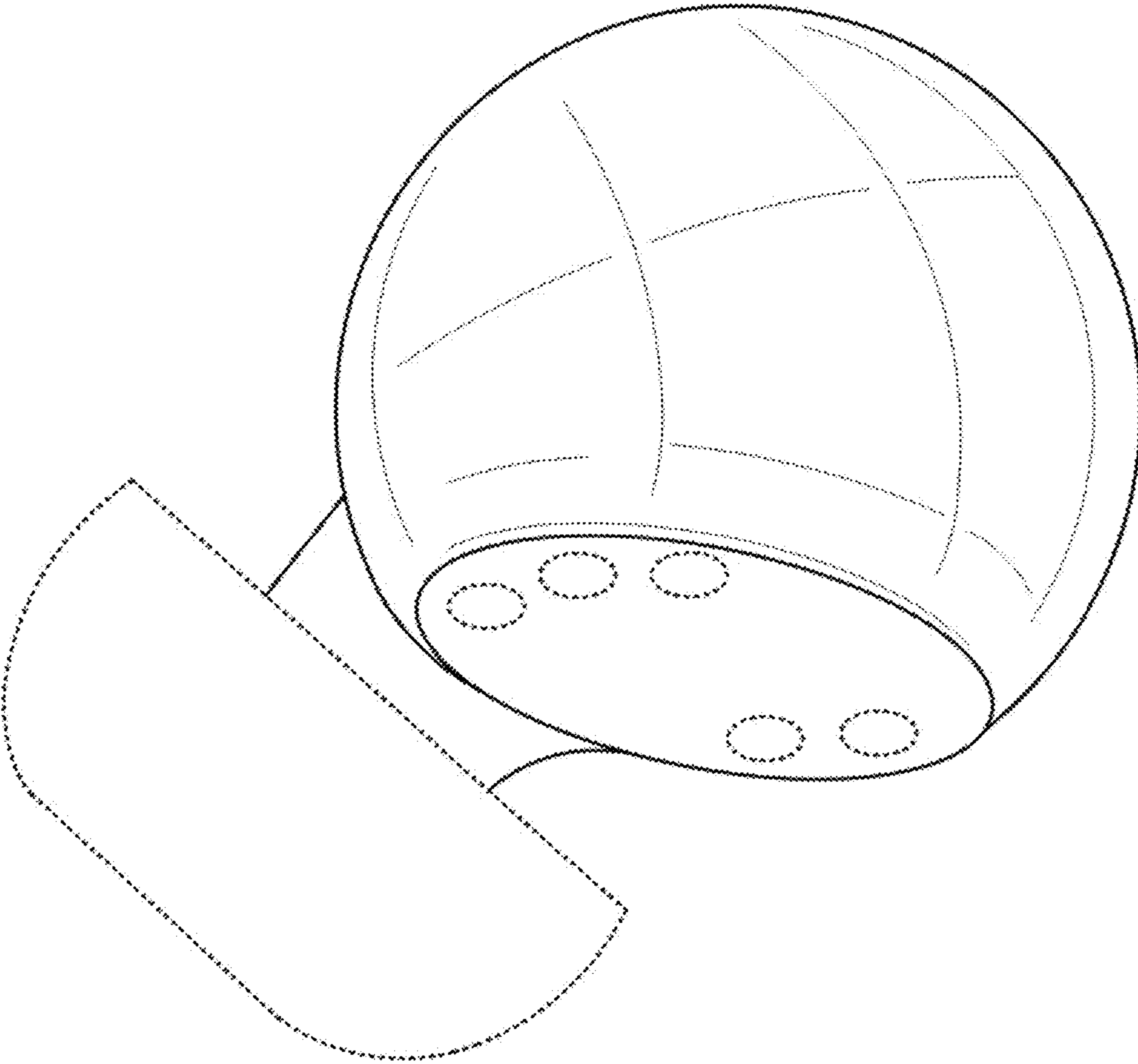

1.1

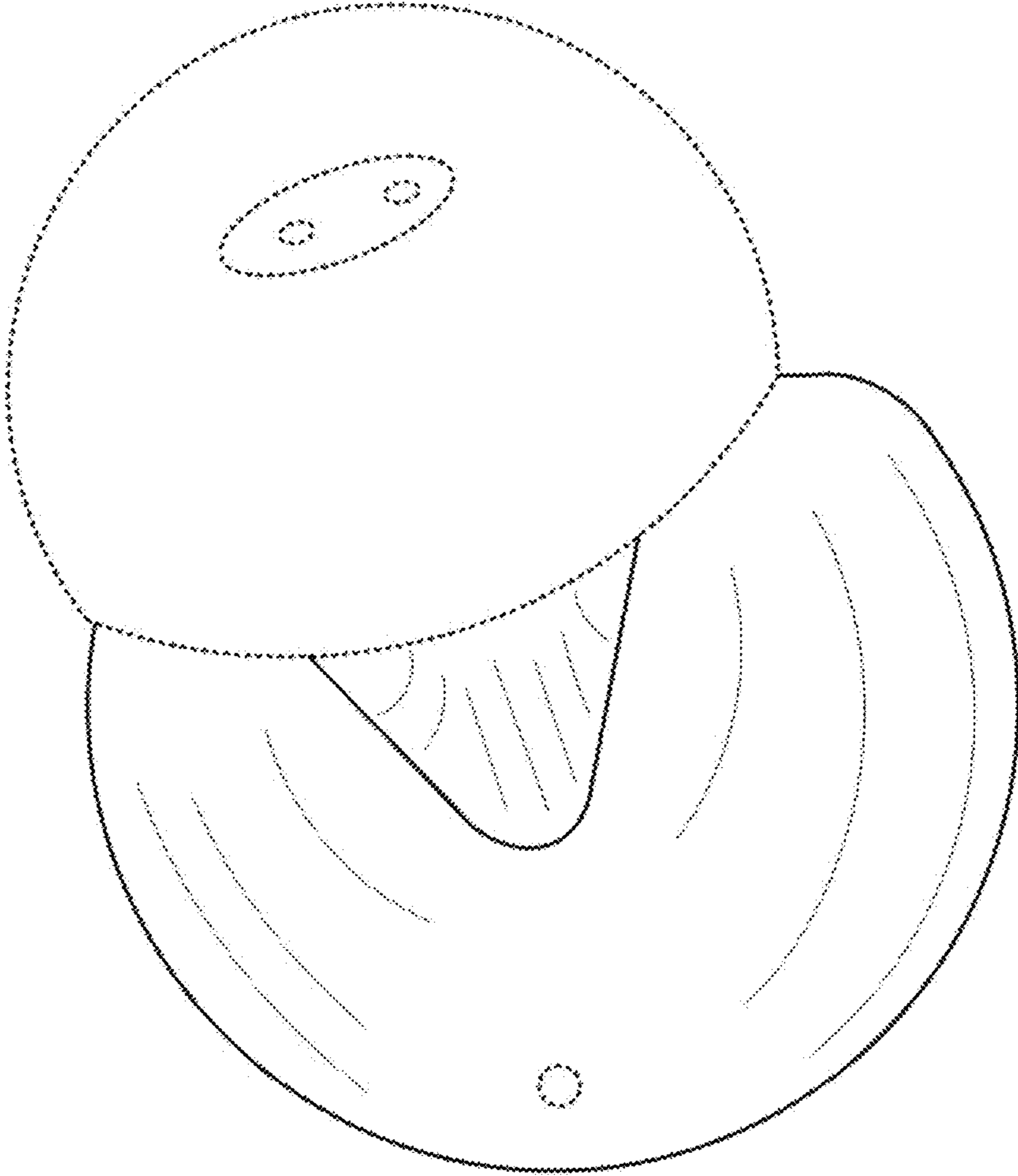

1.2

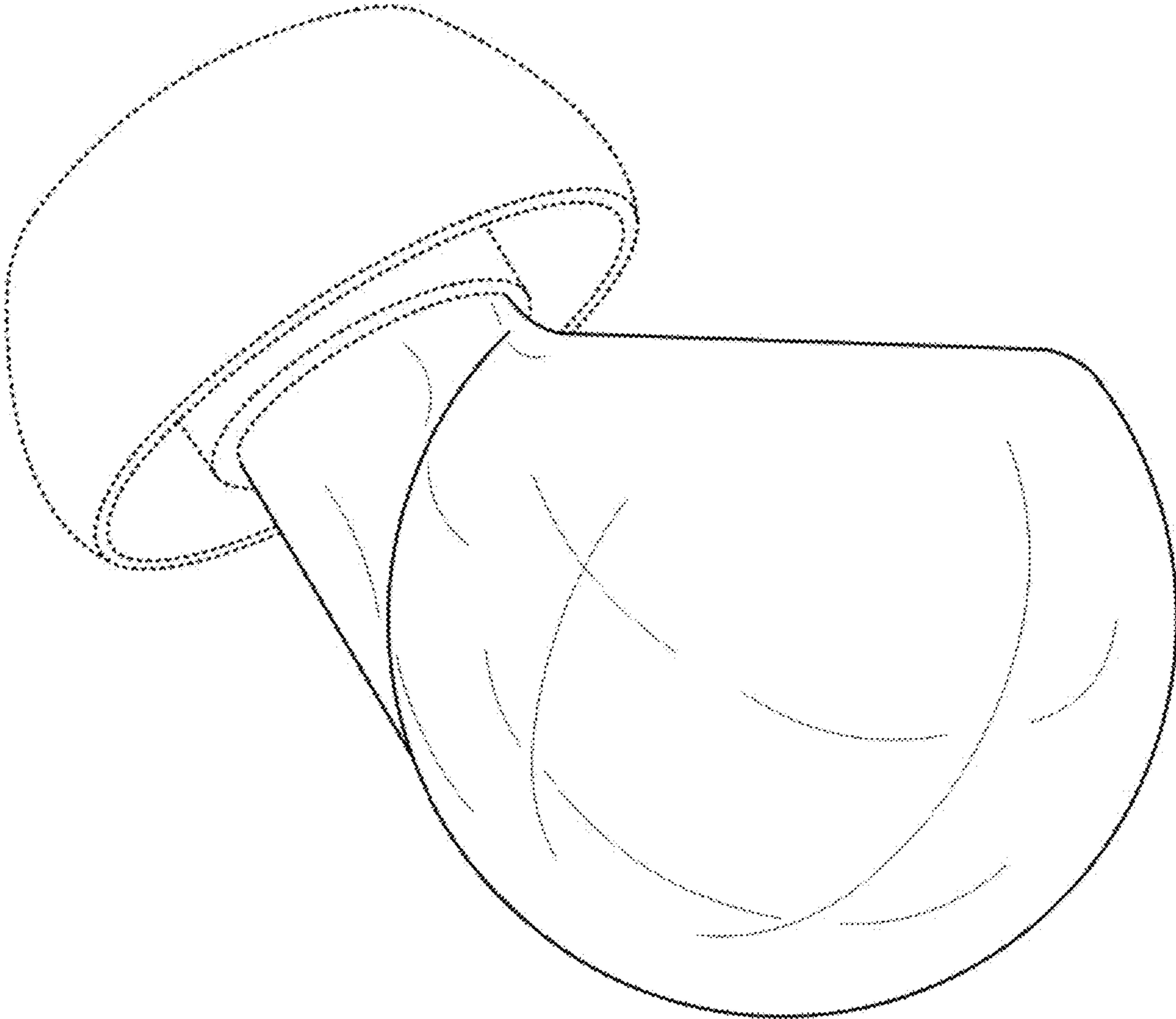

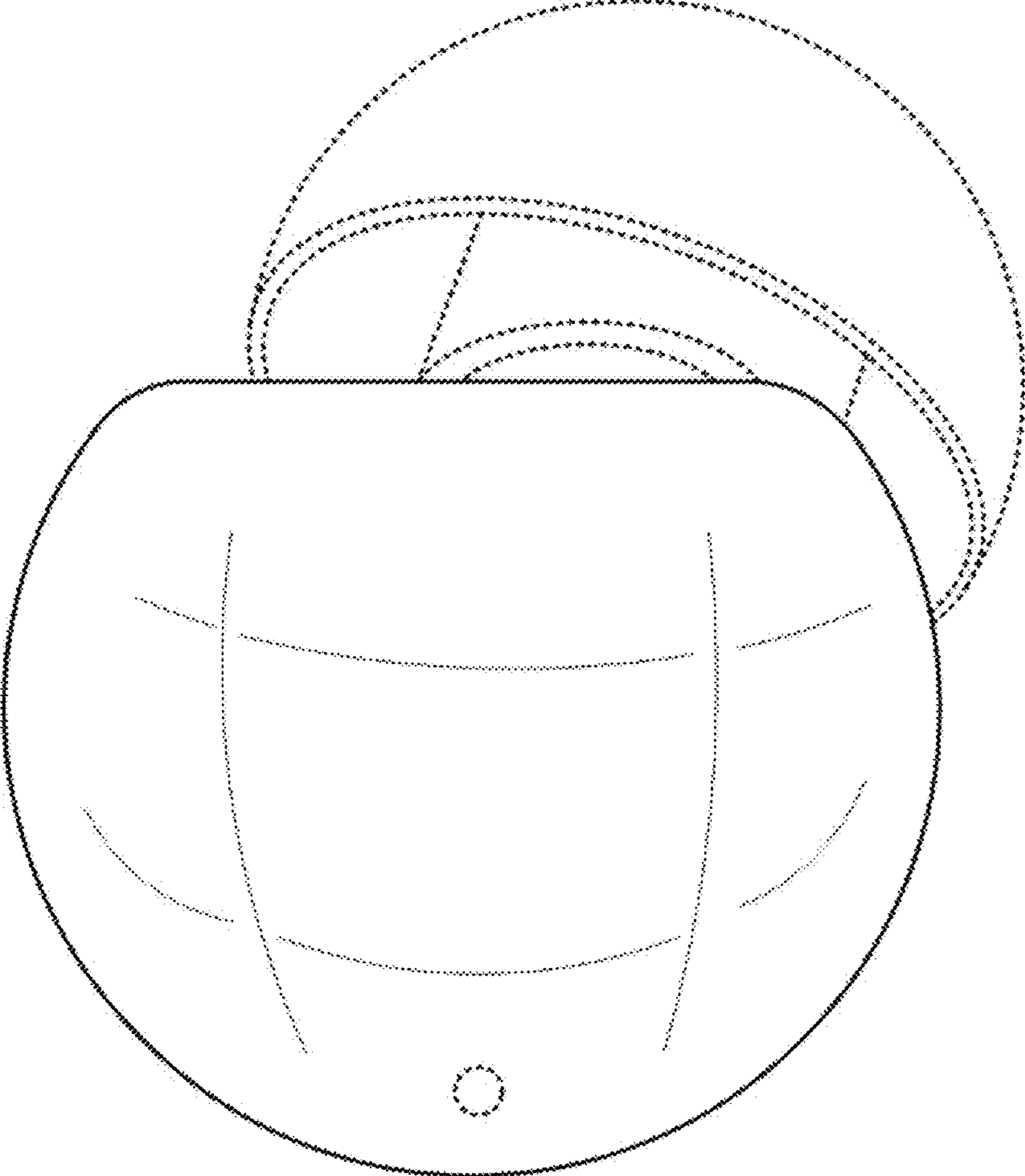

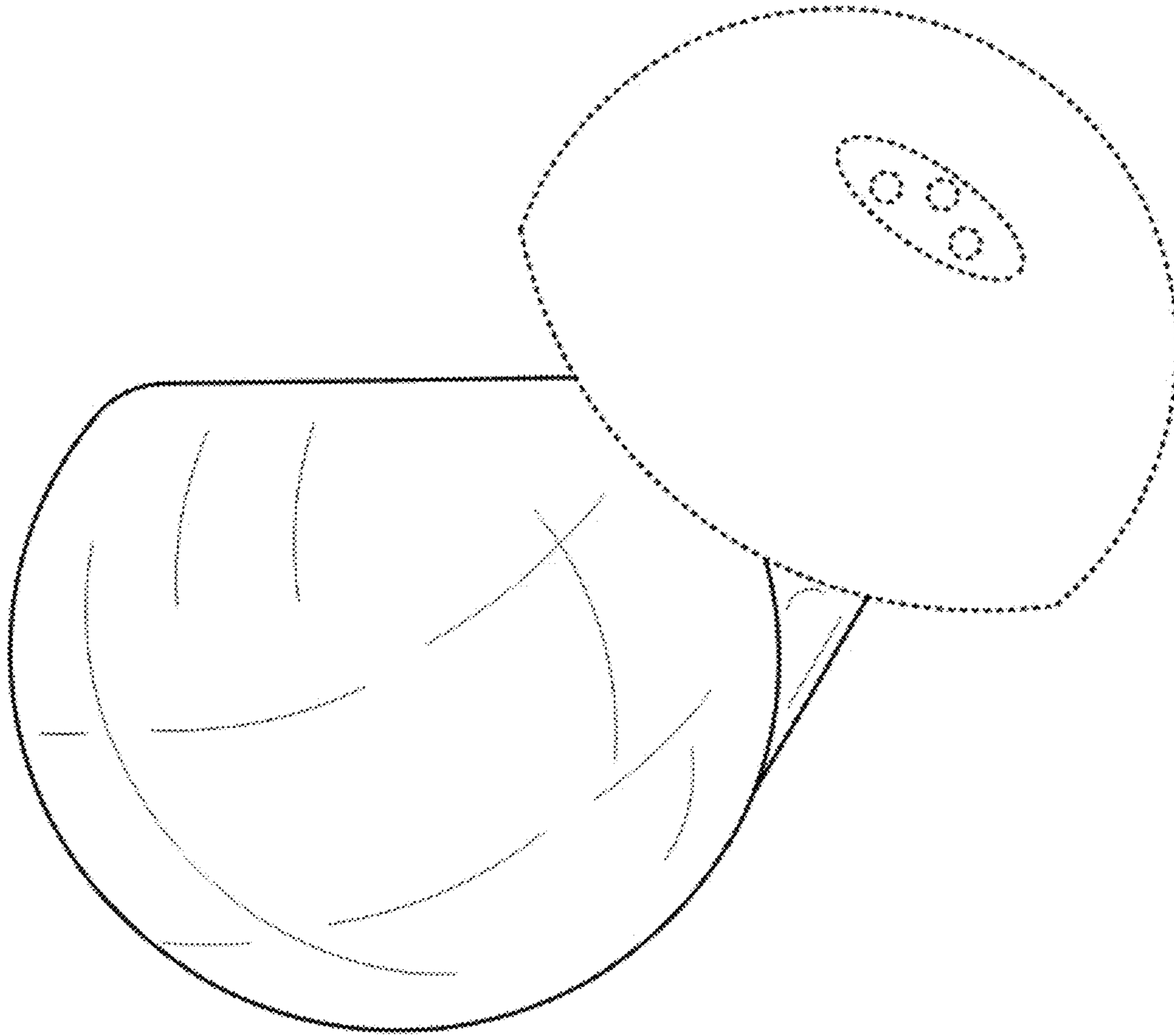

1.5

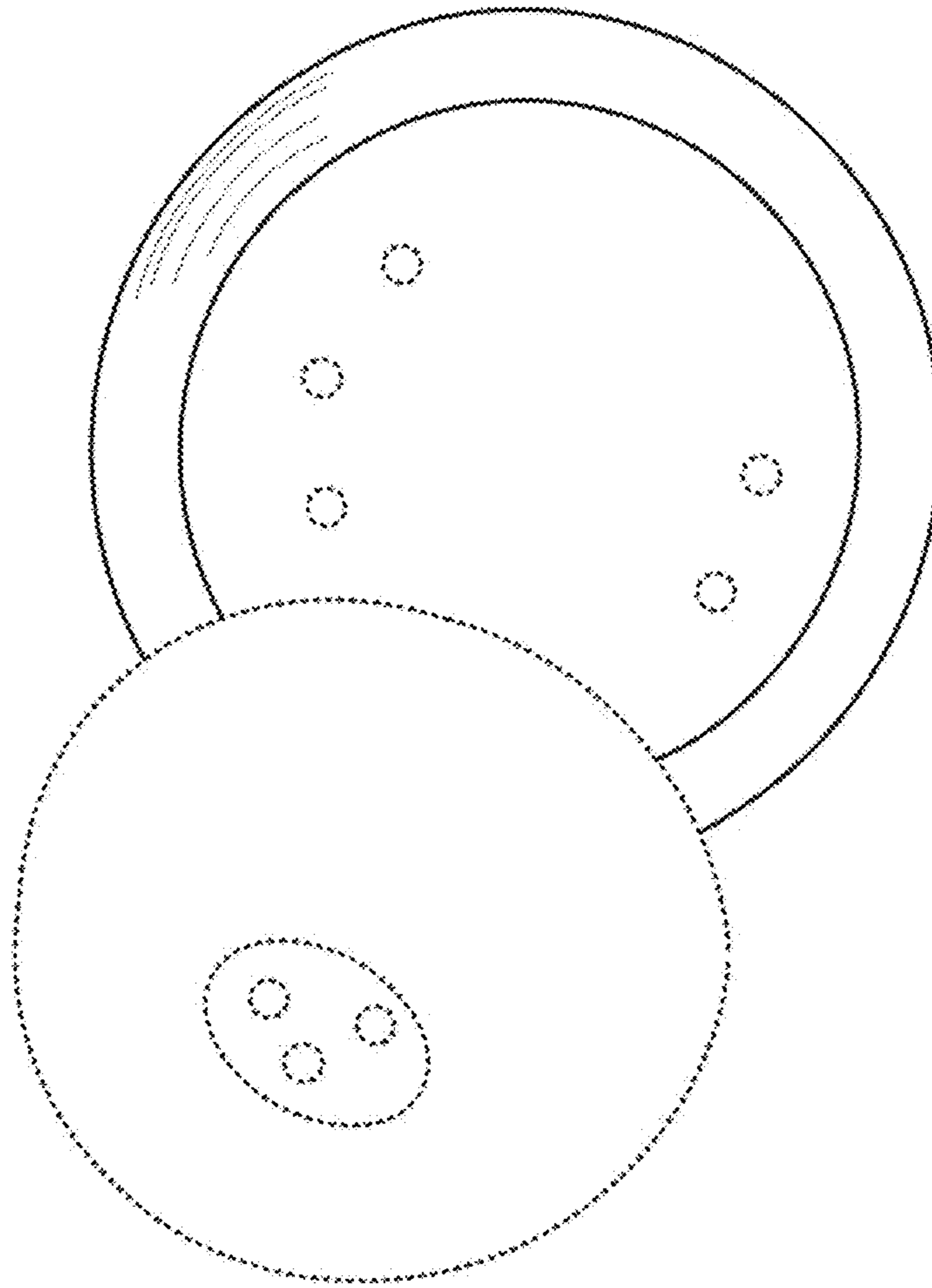

1.6

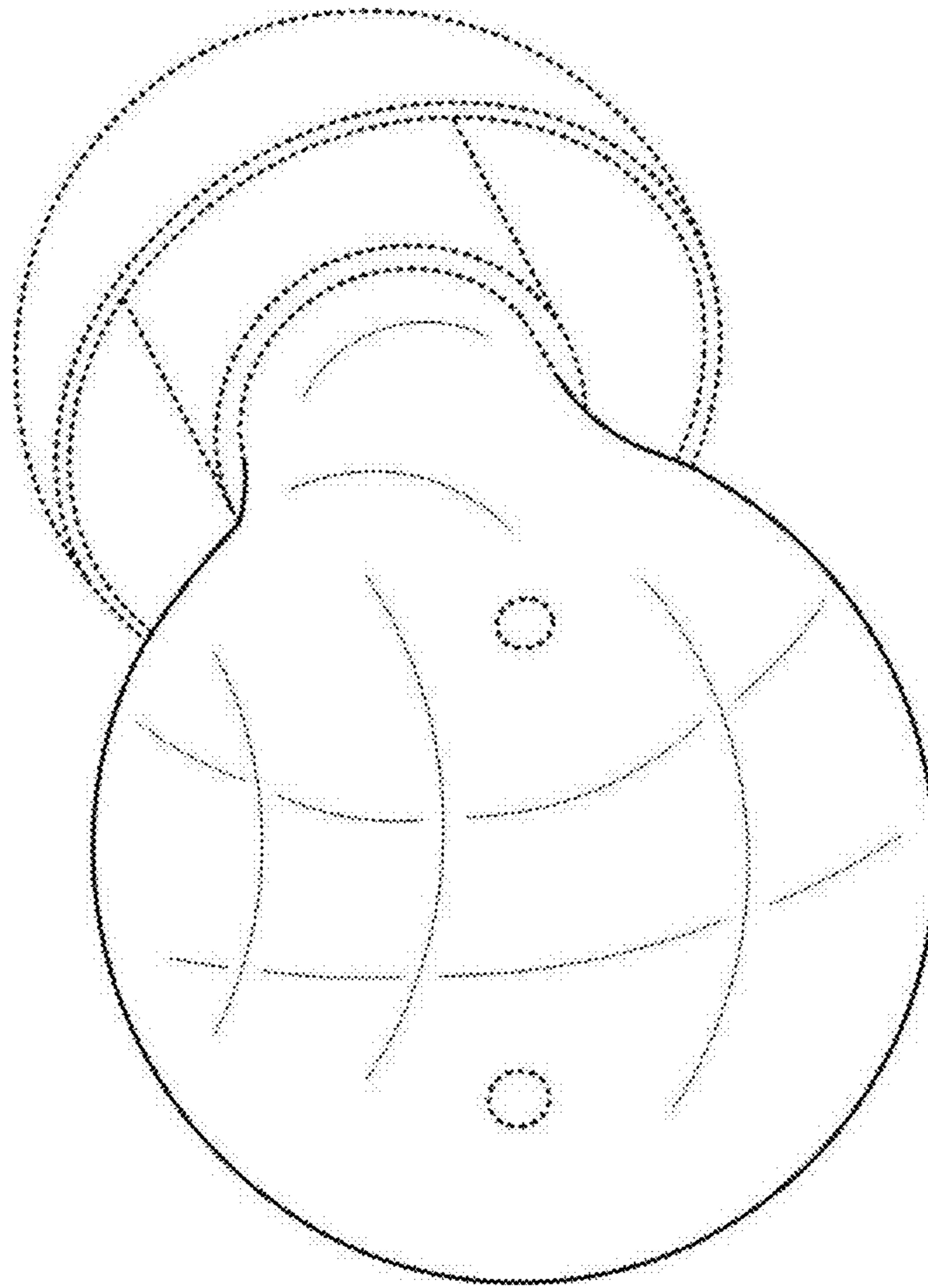

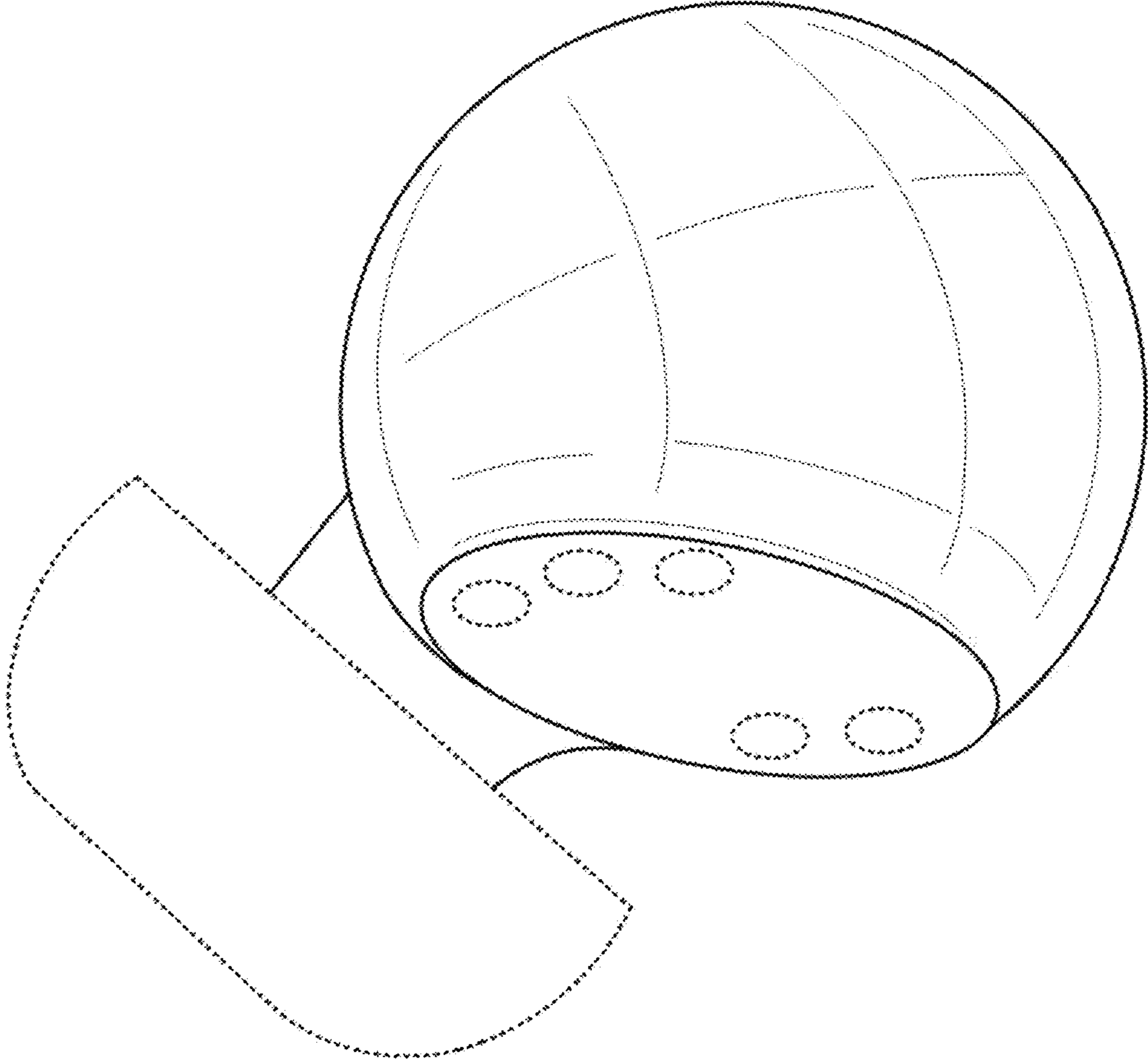

2.1

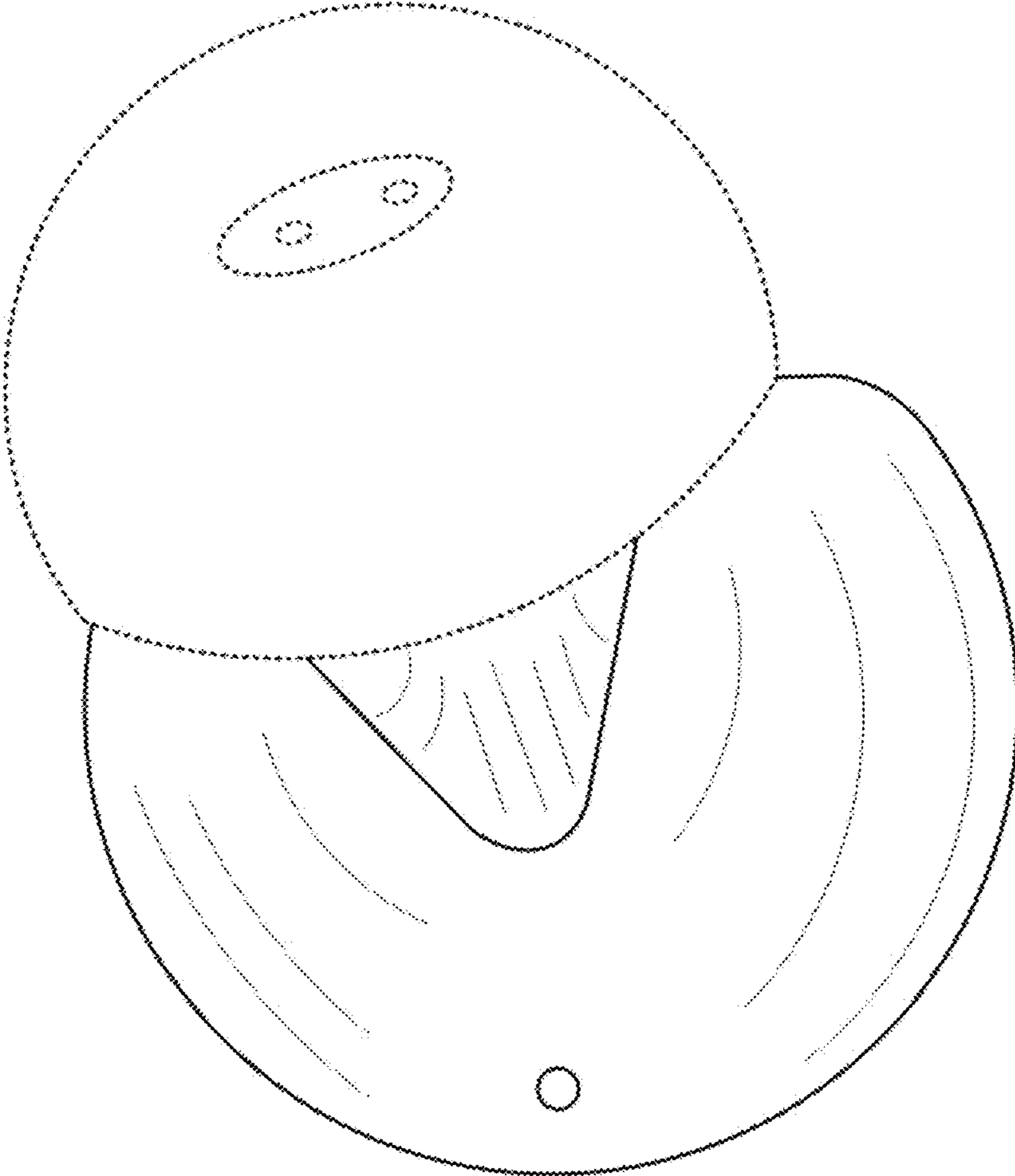

2.2

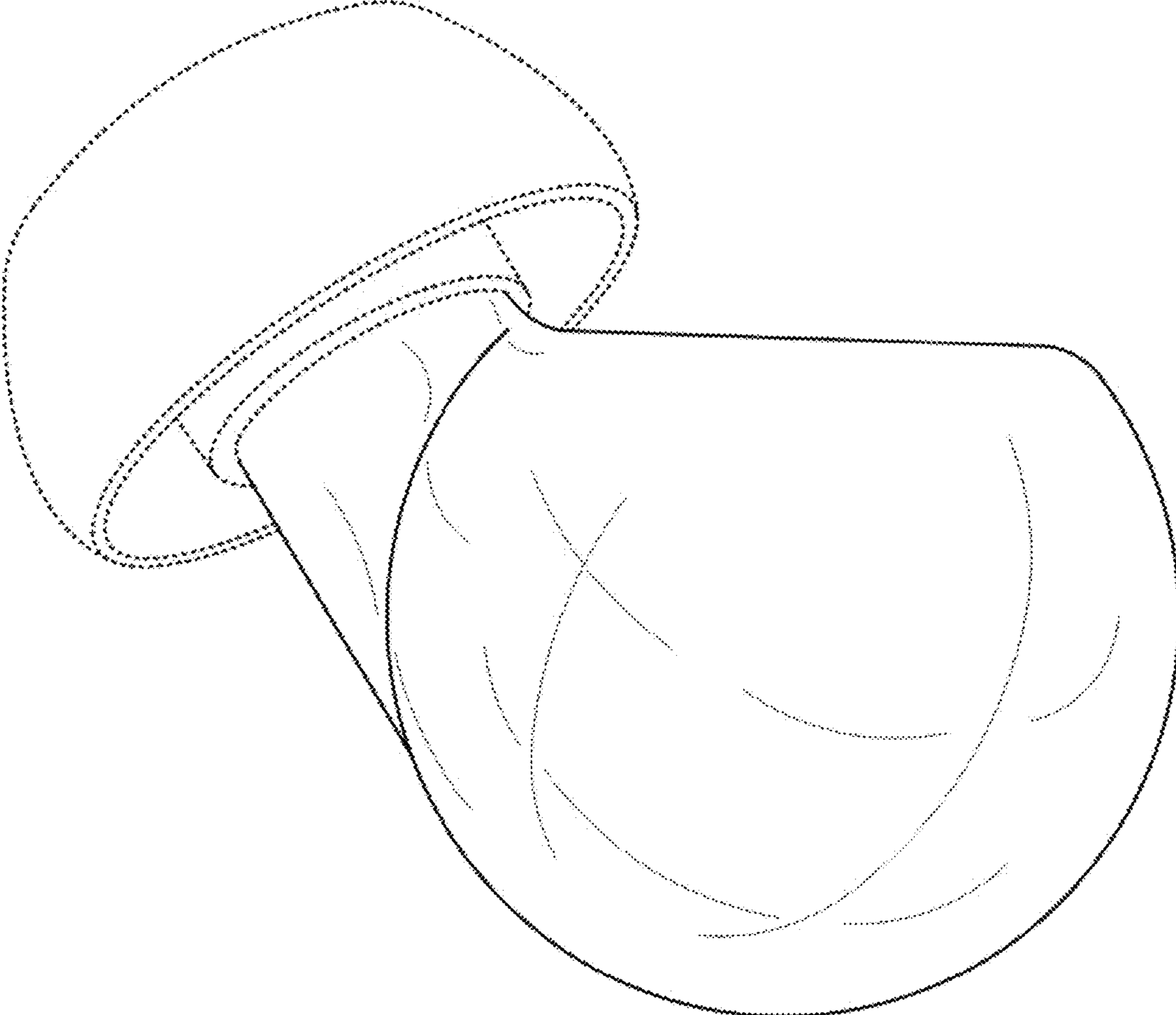

2.3

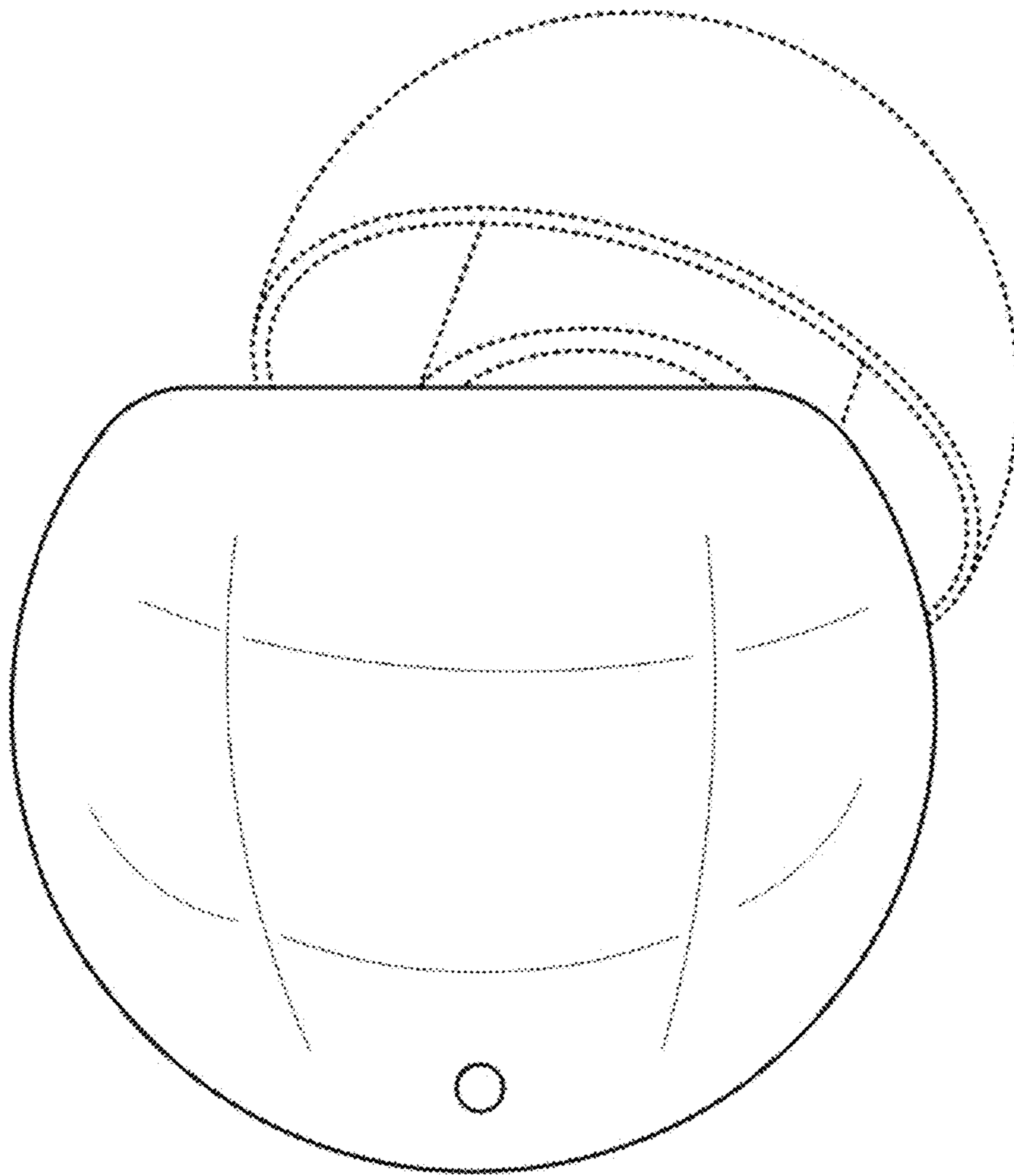

2.4

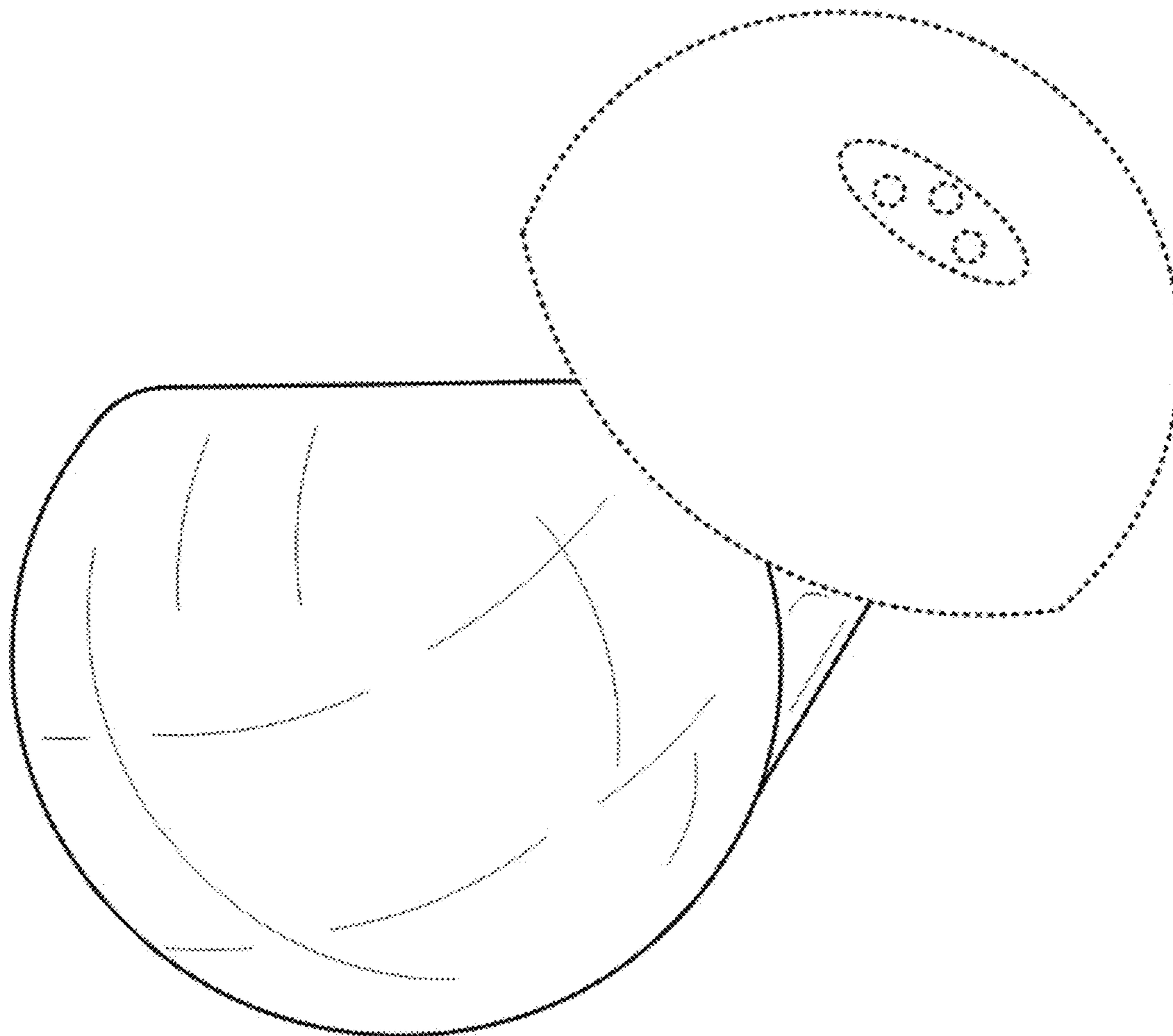

2.5

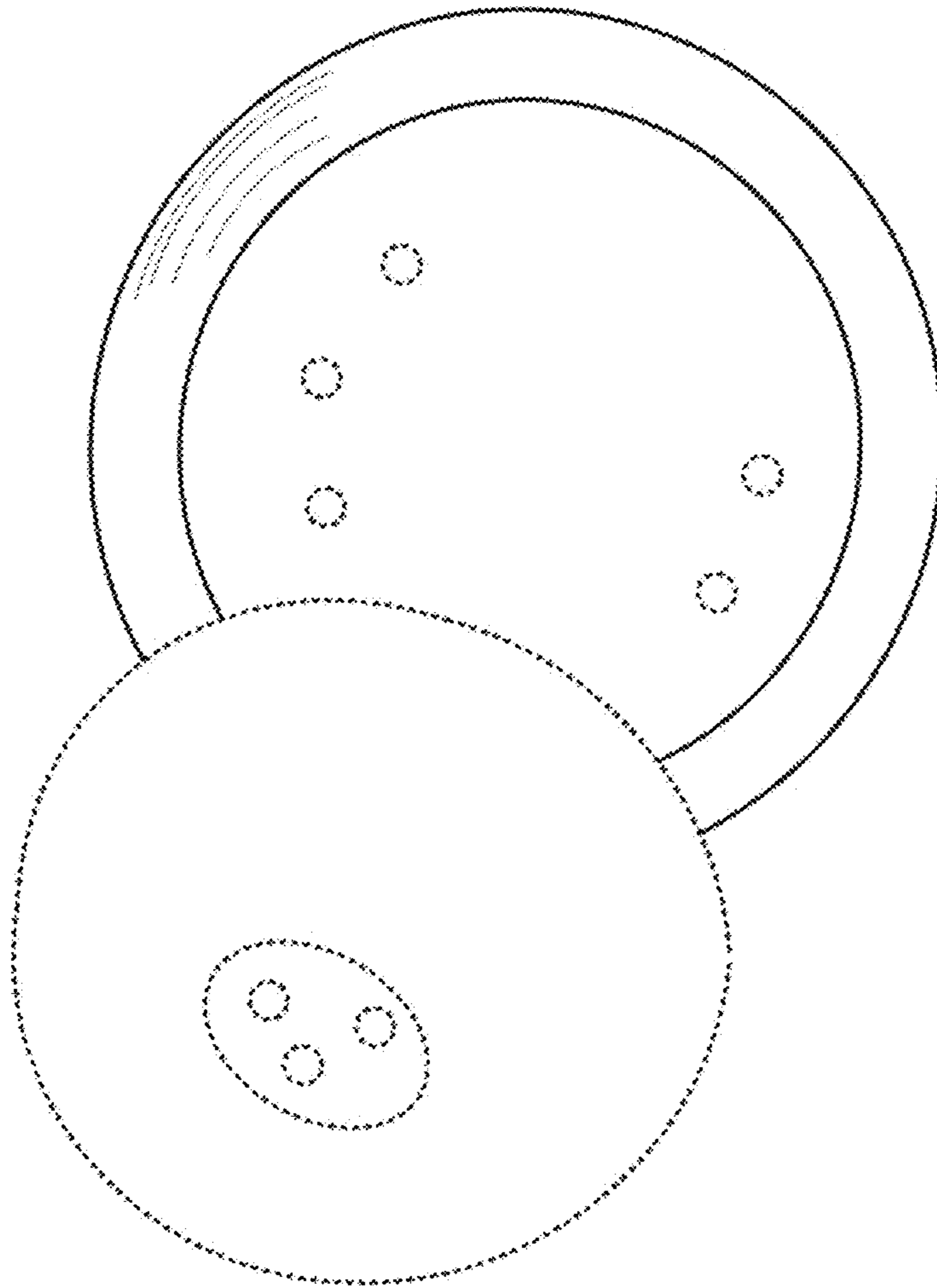

2.6

