



US00D855528S

(12) **United States Design Patent** (10) **Patent No.:** **US D855,528 S**
Re (45) **Date of Patent:** **** Aug. 6, 2019**

(54) **VENT AND DIFFUSER FOR VEHICLE OR REPLICIA THEREOF**

FOREIGN PATENT DOCUMENTS

(71) Applicant: **Aston Martin Lagonda Limited**,
Warwick (GB)

DE 2727517 A1 12/1978
DE 4321969 A1 2/1994
(Continued)

(72) Inventor: **Antonino Lo Re**, Warwick (GB)

OTHER PUBLICATIONS

(73) Assignee: **Aston Martin Lagonda Limited** (GB)

U.S. Appl. No. 29/530,866, filed Jun. 19, 2015.
(Continued)

(**) Term: **15 Years**

(21) Appl. No.: **29/616,014**

Primary Examiner — Susan Bennett Hattan
Assistant Examiner — Suzanne E Tisdell
(74) *Attorney, Agent, or Firm* — Dorsey & Whitney LLP

(22) Filed: **Sep. 1, 2017**

(30) **Foreign Application Priority Data**

(57) **CLAIM**

Mar. 1, 2017 (EM) 003778265-0005

The ornamental design for a vent and diffuser for vehicle or replica thereof, as shown and described.

(51) **LOC (12) Cl.** **12-16**

(52) **U.S. Cl.**
USPC **D12/196**

DESCRIPTION

(58) **Field of Classification Search**
USPC D12/86, 90, 91, 92, 163, 169, 171, 196,
D12/216
CPC B60R 19/02; B60R 19/04; B62D 25/00;
B62D 25/06; B62D 25/08; B62D 35/00
See application file for complete search history.

FIG. 1 is a front perspective view of a vent and diffuser for vehicle or replica thereof in accordance with the present design;
FIG. 2 is a front elevation view thereof;
FIG. 3 is another front perspective view thereof;
FIG. 4 is a right side elevation view thereof;
FIG. 5 is a rear perspective view thereof; and,
FIG. 6 is a top plan view thereof.

(56) **References Cited**

U.S. PATENT DOCUMENTS

D562,747 S * 2/2008 Golden D12/184
D620,396 S 7/2010 Reichman et al.
D626,466 S 11/2010 Reichman et al.
D629,718 S 12/2010 Reichman et al.
D629,719 S 12/2010 Reichman et al.
D629,725 S 12/2010 Reichman et al.
D630,140 S 1/2011 Reichman et al.
D670,640 S 11/2012 Reichman et al.
D680,045 S * 4/2013 Hamilton D12/184
D681,523 S * 5/2013 Messale D12/184

Portions of the vehicle shown in evenly spaced broken lines depict environmental structures that form no part of the claim. Portions of the vent and diffuser shown in dot-dash lines depict an unclaimed boundary between claimed and unclaimed portions of the vehicle.

Any combination of the illustrated features may be claimed in this application or a continuing application claiming priority to this application by converting any of the solid lines to broken lines, any of the broken lines to solid lines, or any combination thereof.

(Continued)

1 Claim, 4 Drawing Sheets

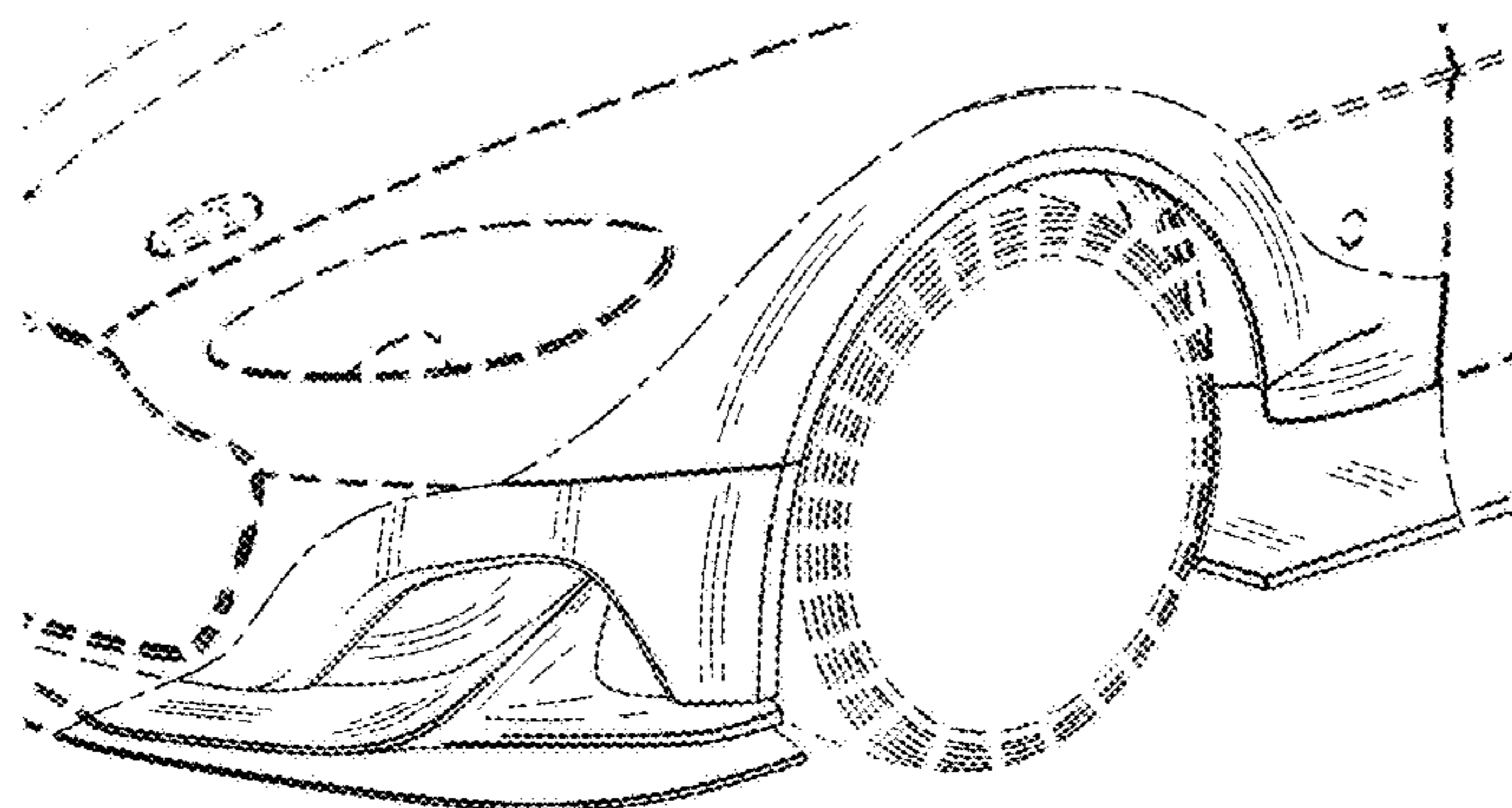

(56)

References Cited

U.S. PATENT DOCUMENTS

D687,348 S 8/2013 Nurnberger
 D689,812 S 9/2013 Reichman et al.
 D691,530 S * 10/2013 Song D12/184
 D692,800 S 11/2013 Wiltshire
 D693,748 S * 11/2013 Mackay D12/184
 D694,686 S * 12/2013 Deluy D12/186
 D695,172 S * 12/2013 Kavaja D12/184
 D703,596 S * 4/2014 Campbell D12/184
 D704,102 S 5/2014 Nurnberger
 D704,601 S 5/2014 Nurnberger
 D711,798 S * 8/2014 O'Donnell D12/184
 D721,314 S * 1/2015 Platto D12/184
 D722,930 S * 2/2015 George D12/184
 D726,079 S 4/2015 Reichman et al.
 D727,804 S 4/2015 Nurnberger
 D730,777 S 6/2015 Nurnberger
 D739,789 S 9/2015 Payne
 D740,188 S * 10/2015 Blanski D12/184
 D740,725 S 10/2015 Payne
 D746,742 S * 1/2016 Curic D12/184
 D749,478 S * 2/2016 Battams D12/184
 D758,247 S 6/2016 Nurnberger et al.
 D762,538 S * 8/2016 Platto D12/184
 9,403,557 B1 * 8/2016 Sharma C21D 1/06
 D766,474 S 9/2016 Holgate et al.
 D772,128 S 11/2016 Platt
 D774,950 S 12/2016 Holgate et al.
 D774,995 S 12/2016 Holgate et al.
 D775,031 S * 12/2016 Frascella D12/184
 D777,070 S 1/2017 Nurnberger
 D778,790 S 2/2017 Nurnberger
 D780,632 S 3/2017 Nurnberger
 D780,633 S 3/2017 Payne et al.
 D780,634 S 3/2017 Segui et al.
 D780,636 S 3/2017 Kahn
 D785,525 S 5/2017 Nurnberger
 D786,155 S 5/2017 Holgate et al.
 D786,744 S 5/2017 Nurnberger et al.
 D787,395 S * 5/2017 Curic D12/181
 D789,856 S * 6/2017 Wolff D12/196
 D796,404 S 9/2017 Nurnberger
 D800,619 S 10/2017 Platt
 D801,558 S 10/2017 Nurnberger et al.
 D817,829 S * 5/2018 Behmer D12/184
 2003/0072094 A1 * 4/2003 Englander B60R 1/0605
 359/871
 2005/0257362 A1 * 11/2005 Andre B62D 25/06
 29/469.5
 2007/0036948 A1 * 2/2007 Jaeger B60R 13/04
 428/192
 2007/0096454 A1 * 5/2007 Iverson B62D 25/18
 280/851
 2007/0182212 A1 * 8/2007 Roux B60R 21/34
 296/198
 2007/0259556 A1 * 11/2007 Parkinson B62D 25/163
 439/374
 2007/0267885 A1 * 11/2007 Thelen B60R 9/00
 296/37.6
 2008/0001390 A1 * 1/2008 Iverson B62D 25/18
 280/848
 2011/0248526 A1 * 10/2011 Hamasaki B62D 25/161
 296/198
 2016/0144902 A1 * 5/2016 Avalos Sartorio B62D 25/18
 280/848
 2016/0207444 A1 * 7/2016 Tatara B60R 11/04
 2018/0009398 A1 * 1/2018 Onishi B32B 3/28

FOREIGN PATENT DOCUMENTS

EM 0002129230001 10/2004
 EM 0002129230002 10/2004
 EM 0010678390001 1/2009
 EM 0016500520001 12/2009
 EM 0016746310001 2/2010

EM 0016746310002 2/2010
 EM 0016746310003 2/2010
 EM 0016746310005 2/2010
 EM 0019998480001 2/2012
 EM 0019998480003 2/2012
 EM 0020336210001 4/2012
 EM 0020336210003 4/2012
 EM 0020336210005 4/2012
 EM 0020336210006 4/2012
 EM 0020479770002 5/2012
 EM 0021714880001 1/2013
 EP 0896892 A1 2/1999
 EP 0906863 A2 7/1999
 EP 2476603 A2 7/2012
 GB 2327912 A 2/1999
 GB 3013456 7/2003
 GB 2396881 A 7/2004
 GB 3024223 3/2006
 JP 1400694 8/2010
 JP 1444677 6/2012
 WO 0212028 A1 2/2002

OTHER PUBLICATIONS

U.S. Appl. No. 29/534,648, filed Jul. 30, 2015.
 U.S. Appl. No. 29/542,940, filed Oct. 19, 2015.
 U.S. Appl. No. 29/573,909, filed Aug. 10, 2016.
 U.S. Appl. No. 29/583,268, filed Nov. 3, 2016.
 U.S. Appl. No. 29/583,272, filed Nov. 3, 2016.
 U.S. Appl. No. 29/583,278, filed Nov. 3, 2016.
 U.S. Appl. No. 29/584,625, filed Nov. 16, 2016.
 U.S. Appl. No. 29/584,629, filed Nov. 16, 2016.
 U.S. Appl. No. 29/589,582, filed Jan. 3, 2017.
 U.S. Appl. No. 29/589,583, filed Jan. 3, 2017.
 U.S. Appl. No. 29/589,586, filed Jan. 3, 2017.
 U.S. Appl. No. 29/589,618, filed Jan. 3, 2017.
 U.S. Appl. No. 29/589,621, filed Jan. 3, 2017.
 U.S. Appl. No. 29/595,005, filed Feb. 24, 2017.
 U.S. Appl. No. 29/604,102, filed May 15, 2017.
 U.S. Appl. No. 29/616,003, filed Sep. 1, 2017.
 U.S. Appl. No. 29/616,006, filed Sep. 1, 2017.
 U.S. Appl. No. 29/616,008, filed Sep. 1, 2017.
 U.S. Appl. No. 29/616,010, filed Sep. 1, 2017.
 U.S. Appl. No. 29/542,940, filed Oct. 19, 2015, Kahn.
 U.S. Appl. No. 29/573,909, filed Aug. 10, 2016, Cooper.
 U.S. Appl. No. 29/582,156, filed Oct. 25, 2016, Earley.
 U.S. Appl. No. 29/582,165, filed Oct. 25, 2016, Earley.
 U.S. Appl. No. 29/582,167, filed Oct. 25, 2016, Earley.
 U.S. Appl. No. 29/582,170, filed Oct. 25, 2016, Earley.
 U.S. Appl. No. 29/583,268, filed Nov. 3, 2016, Nurnberger et al.
 U.S. Appl. No. 29/583,272, filed Nov. 3, 2016, Nurnberger et al.
 U.S. Appl. No. 29/583,278, filed Nov. 3, 2016, Nurnberger et al.
 U.S. Appl. No. 29/584,625, filed Nov. 16, 2016, Nurnberger et al.
 U.S. Appl. No. 29/584,629, filed Nov. 16, 2016, Nurnberger et al.
 U.S. Appl. No. 29/589,582, filed Jan. 3, 2017, Nurnberger et al.
 U.S. Appl. No. 29/589,583, filed Jan. 3, 2017, Nurnberger et al.
 U.S. Appl. No. 29/589,586, filed Jan. 3, 2017, Nurnberger et al.
 U.S. Appl. No. 29/589,618, filed Jan. 3, 2017, Nurnberger et al.
 U.S. Appl. No. 29/589,621, filed Jan. 3, 2017, Nurnberger et al.
 U.S. Appl. No. 29/595,005, filed Feb. 24, 2017, Nurnberger et al.
 U.S. Appl. No. 29/604,102, filed May 15, 2017, Nurnberger et al.
 U.S. Appl. No. 29/616,003, filed Sep. 1, 2017, Re et al.
 U.S. Appl. No. 29/616,006, filed Sep. 1, 2017, Re et al.
 U.S. Appl. No. 29/616,008, filed Sep. 1, 2017, Re et al.
 U.S. Appl. No. 29/616,010, filed Sep. 1, 2017, Re et al.
 U.S. Appl. No. 29/621,813, filed Oct. 11, 2017, Nurnberger et al.
 U.S. Appl. No. 29/621,815, filed Oct. 11, 2017, Nurnberger et al.
 U.S. Appl. No. 29/626,411, filed Nov. 16, 2017, Nurnberger et al.
 U.S. Appl. No. 29/626,415, filed Nov. 16, 2017, Nurnberger et al.
 U.S. Appl. No. 29/626,419, filed Nov. 16, 2017, Hill et al.
 U.S. Appl. No. 29/626,801, filed Nov. 20, 2017, Hill et al.
 U.S. Appl. No. 29/631,883, filed Jan. 3, 2018, Hill et al.
 U.S. Appl. No. 29/631,887, filed Jan. 3, 2018, Hill et al.

(56)

References Cited

OTHER PUBLICATIONS

“2009 Aston Martin Vantage 2-door Coupe Man Grille”. Found online Mar. 21, 2016 at motorauthority.com. Page dated c. 2009. Retrieved from http://www.motorauthority.com/image/100236184_2009-aston-martin-vantage-2-door-coupe-man-grille.

“2011 Aston Martin One-77.” Electronic Brochure., Jun. 22, 2010 [online], [retrieved on Sep. 5, 2014]. Retrieved from the Internet <URL: http://www.auto-brochures.com/makes/Aston_Martin/one-77/Aston%20Martin_int%20one-77.pdf>.

“2012 Aston Martin Virage”, Online Review dated Mar. 21, 2012 (Retrieved from the Internet Jan. 20, 2016), Available at <http://www.autoblog.com/2012/03/21/2012-aston-martin-virage-review-road-test>.

“Aston Martin Sedan/Lagonda Spy Photos”. Found online Mar. 21, 2016 at forums.nasioc.com. Page dated May 9, 2014. Retrieved from <http://forums.nasioc.com/forums/showthread.php?t=2628222>.

“Cars Wheels Design”, Online Blog dated Oct. 13, 2011 (Retrieved from the Internet Jan. 20, 2016), Available at <http://wheelsdesigns.blogspot.com/2011/10/aston-martin-wheels.html>.

“eAutoZine: Aston Martin Lagonda Returns in Summer 2014”. Found online Mar. 21, 2016 at eautozine.com. Page dated Jun. 22, 2014. Retrieved from <http://www.eautozine.com/page/4/>.

1976 and 1987 Aston Martin Lagonda, [online], [site visited Jul. 24, 2014], Available from Internet, <URL: <http://www.astonmartin.com/heritage/past-models/lagonda>>, 2 pages.

2003 Aston Martin DB7 Vantage, [online], [site visited Jan. 3, 2014], Available from Internet, <URL: <http://www.conceptcarz.com/view/photo/291097,6877/2003-Aston-Martin-DB7-Vantage.aspx>>, 2 pages.

2011 Aston Martin Rapide, [online article Feb. 4, 2010, [site visited Jan. 3, 2014], Available from Internet, <URL: http://www.roadandtrack.com/car-reviews/first-drives/photos-2011-aston-martin-rapide?click=main_sr#slide-1>, 6 pages.

2014 Aston Martin Rapide S, announced Dec. 30, 2013, [online], [site visited Jan. 3, 2014], Available from Internet, <URL: <http://www.astonmartin.com/en-us/cars/rapide-s>>, 35 pages.

Aston Martin 2013, “Aston Martin Centenary Celebration Programme,” 2013; 204 pages.

Aston Martin DB9 Brochure; Website[online]: <http://www.auto-brochures.com>, Jan. 27, 2012 [retrieved on Oct. 22, 2013]. Retrieved

from the internet: <URL: http://www.auto-brochures.com/makes/Aston_Martin/db9/Aston%20Martin_int%20DB9_1.pdf>; 41 pages.

Aston Martin IDBS Brochure; Website[online]: <http://www.auto-brochures.com>, Jan. 27, 2012 [retrieved on Oct. 22, 2013]. Retrieved from the internet: <URL: http://www.auto-brochures.com/makes/Aston_Martin/dbs/Aston%20Martin_int%20DBS_1.pdf>; 62 pages.

Aston Martin, “Vulcan”, <http://www.astonmartin.com/vulcan> [Retrieved from the Internet on Oct. 21, 2016], 2 Pages.

European Patent Office; PCT International Preliminary Examination Report dated Dec. 5, 2002; PCT/GB01/03563; 11 pages.

European Patent Office; PCT International Search Report dated Nov. 21, 2001; PCT/GB01/03563; 3 pages.

European Patent Office; PCT Written Opinion dated Aug. 21, 2002; PCT/GB01/03563; 5 pages.

European Patent Office; PCT Written Opinion dated Mar. 6, 2002; PCT/GB01/03563; 5 pages.

Youtube, “First Look: Aston Martin Vulcan—Geneva 2015”, <https://www.youtube.com/watch?v=weY6qeOJIBe>, Published Mar. 5, 2015, 2 Pages.

“Extremely Striking ‘Bespoke’ Aston Martin Super-Saloon Spied”. Found online Mar. 21, 2016 at forums.vwvortex.com. Page dated May 8, 2014., Retrieved from <http://forums.vwvortex.com/showthread.php?6969673-Extremely-striking-quot-Bespoke-quot-Aston-Martin-super-saloon-spied-Built-by-0-by-Aston-Martin-will-be-very-limited-run-could-be-badged-Lagonda>.

Carrion, Annette. “2014 Aston Martin Vanquish Volante Neiman Marcus . . .” European Car Web., Jun. 22, 2010 [online], [retrieved on Sep. 5, 2014]., Retrieved from the Internet <URL: http://www.europeancarweb.com/news/1311_2014_aston_martin_vanquish_volante_neiman_marcus_edition/photo_06.html>.

Vijayenthiran, Viknesh. “Aston Martin Builds and Sells Two CC100 Speedsters: Report.” Motor Authority., Jul. 26, 2013 [online], [retrieved on Sep. 5, 2014]., Retrieved from the Internet <URL: http://www.motorauthority.com/news/1085797_aston-martin-builds-and-sells-two-cc100-speedsters-report>.

2008 Aston Martin DB9 Grill & Front View Photo. Website[online]: <http://www.motortrend.com>, Jun. 12, 2008 [retrieved on Oct. 22, 2013]., Retrieved from the internet: <URL: http://www.motortrend.com/cars/2008/aston_martin/db9/photos/exterior/grill_front_view.html>; 1 page.

* cited by examiner

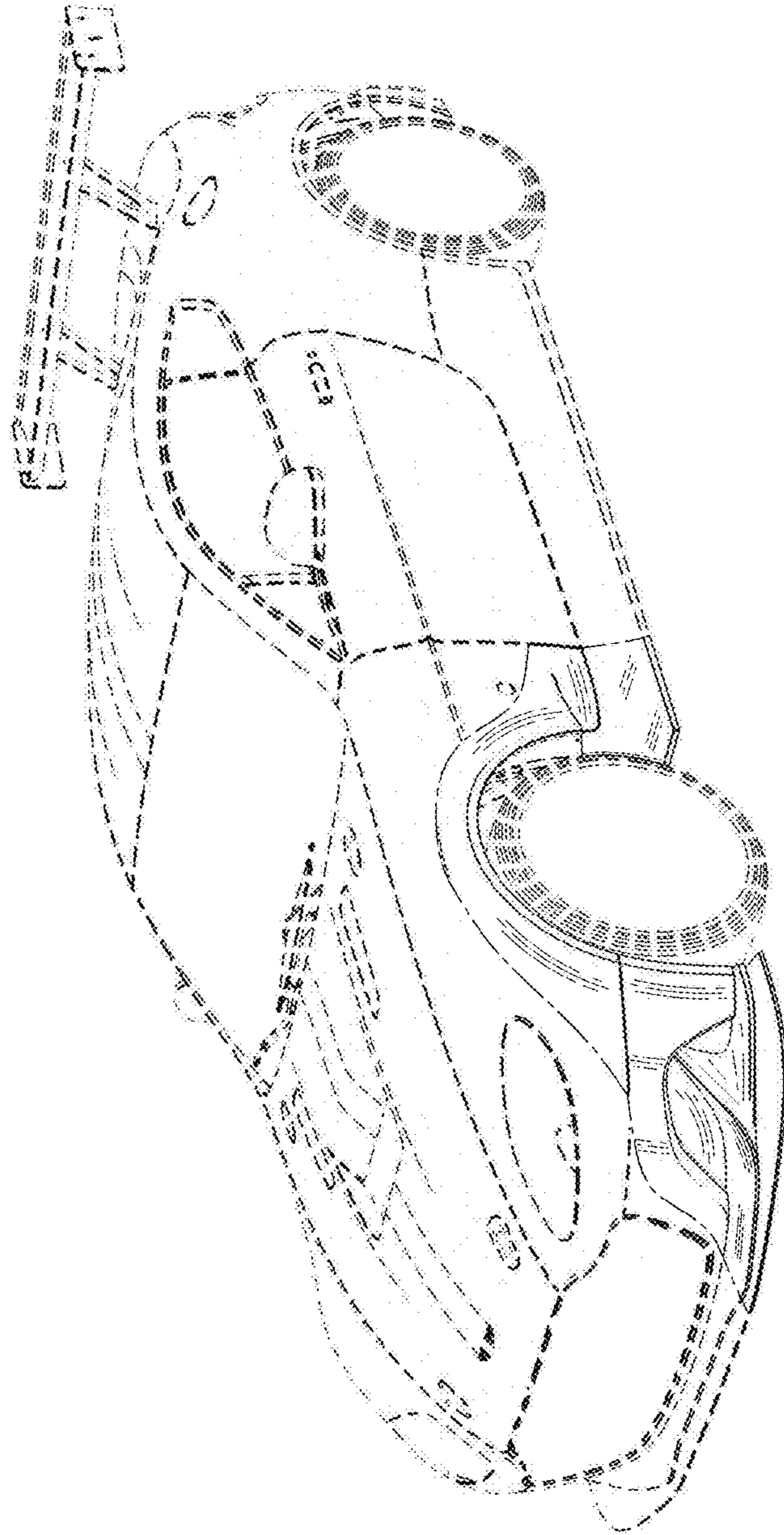

Fig. 1

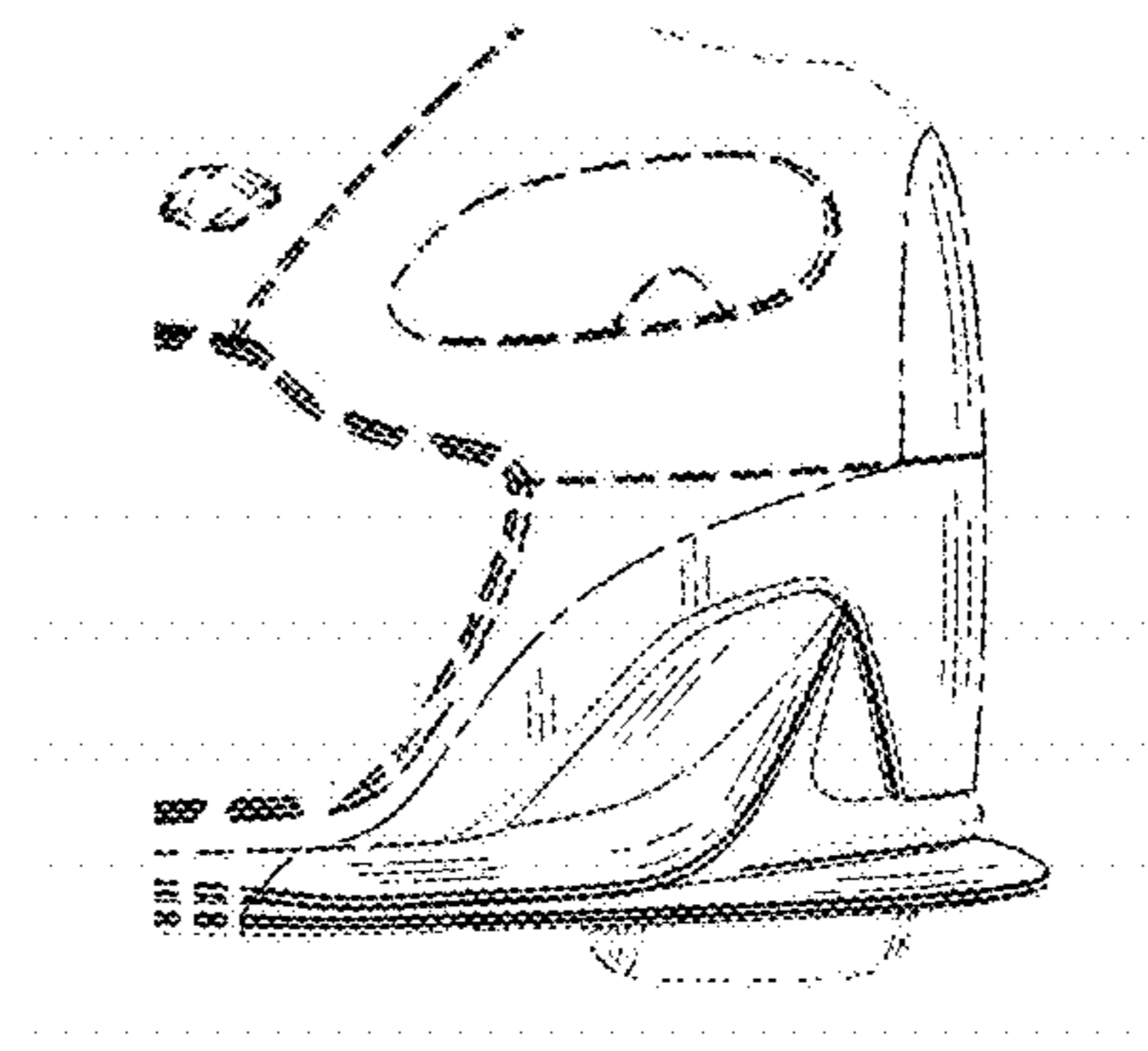

Fig. 2

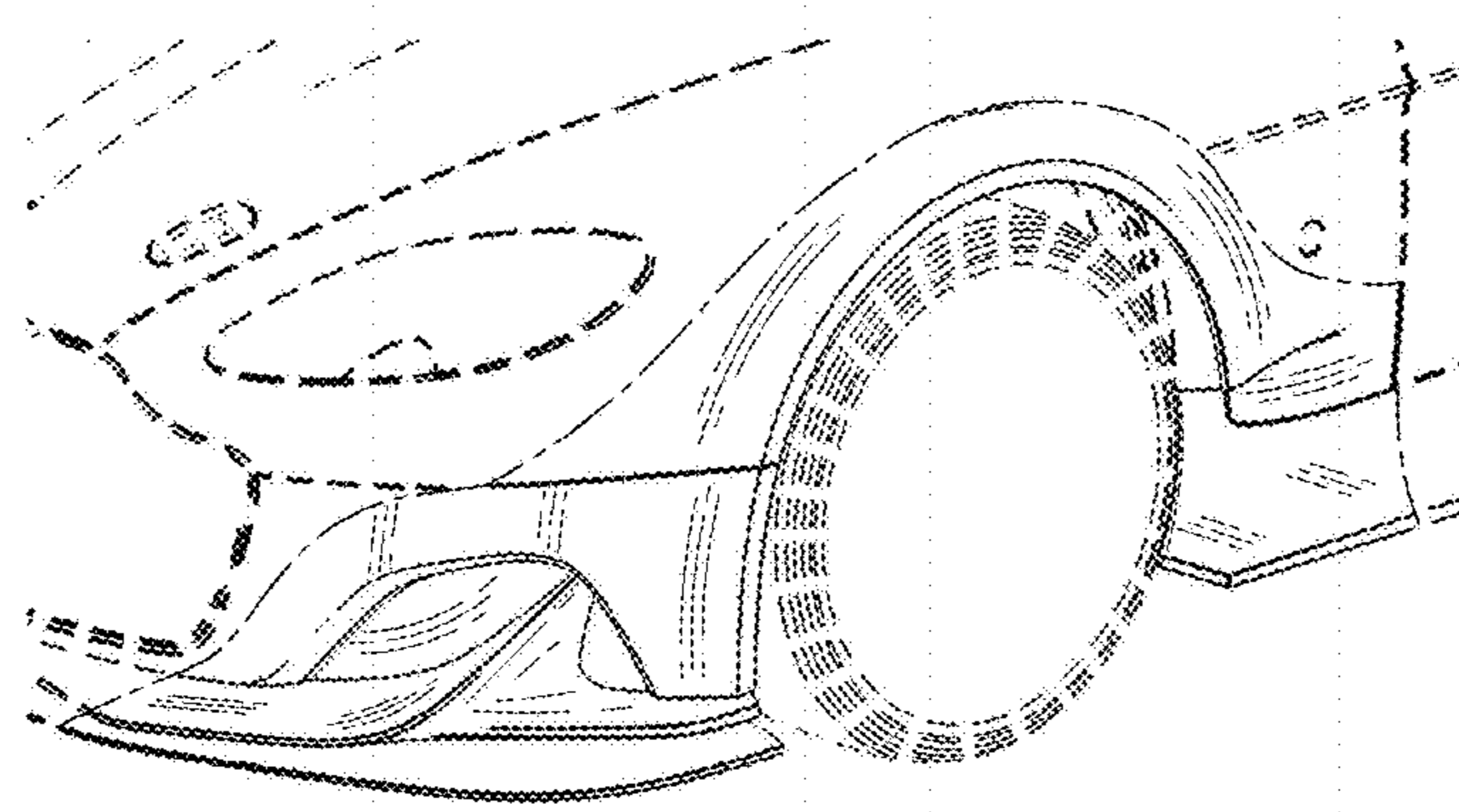

Fig. 3

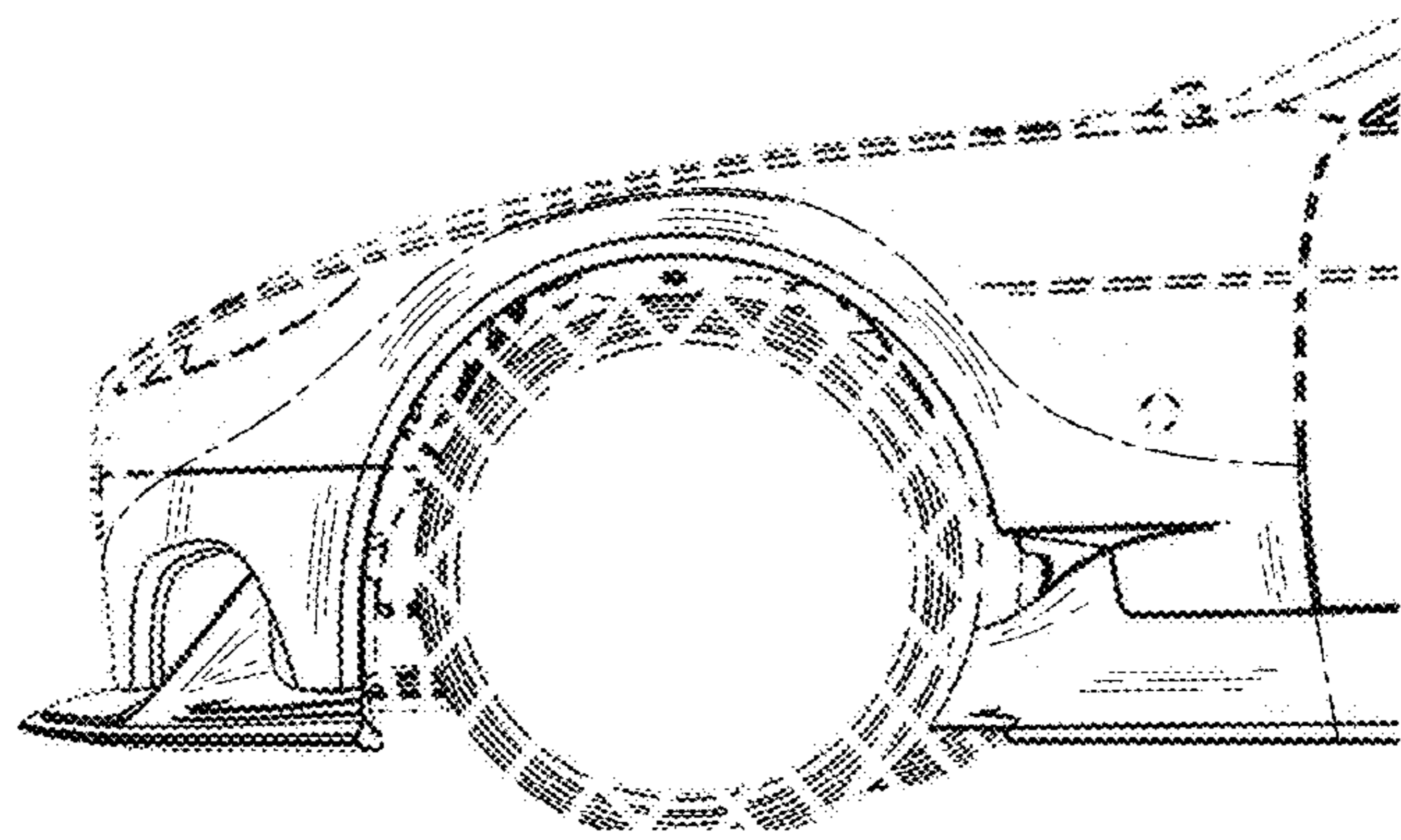

Fig. 4

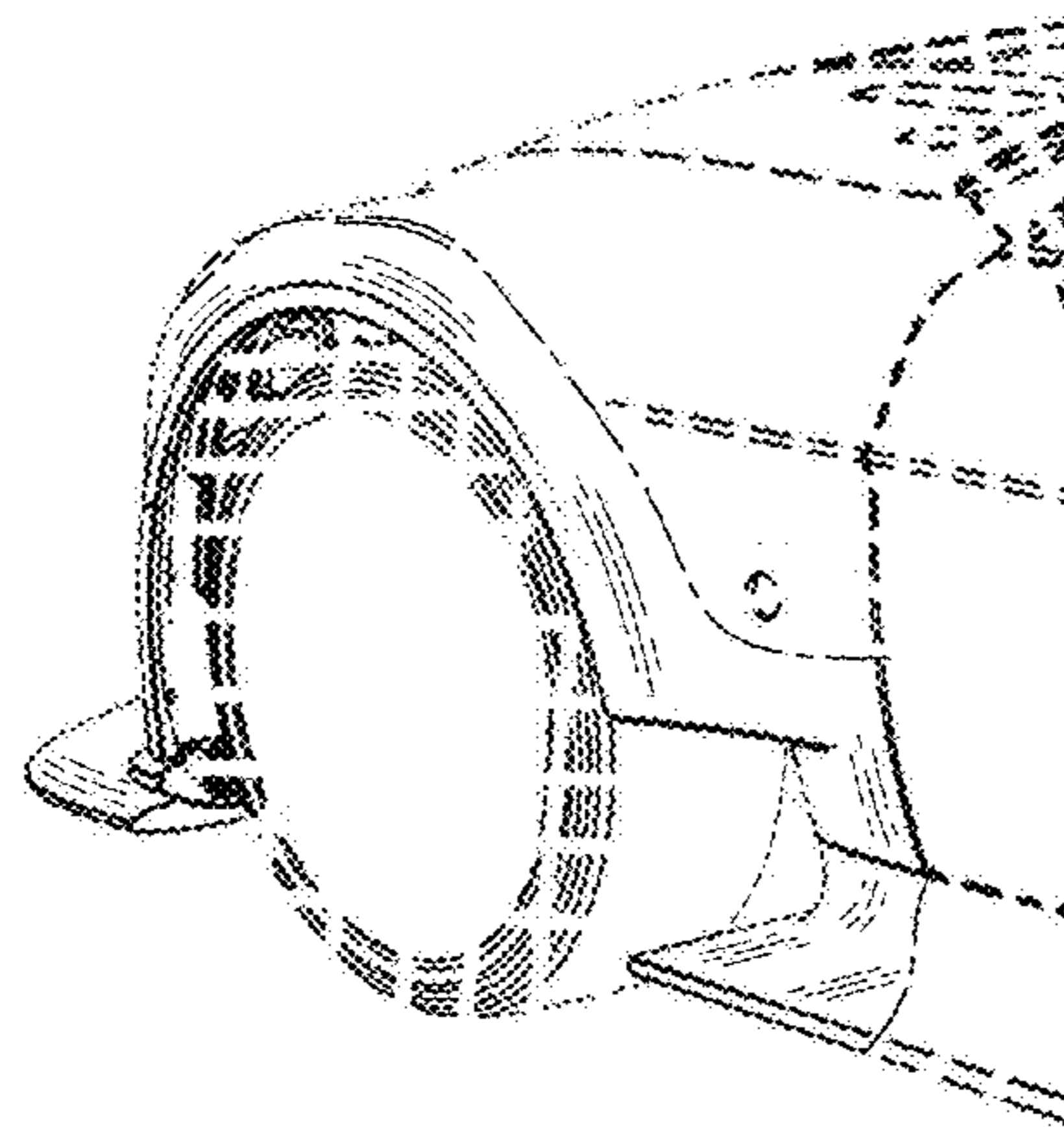

Fig. 5

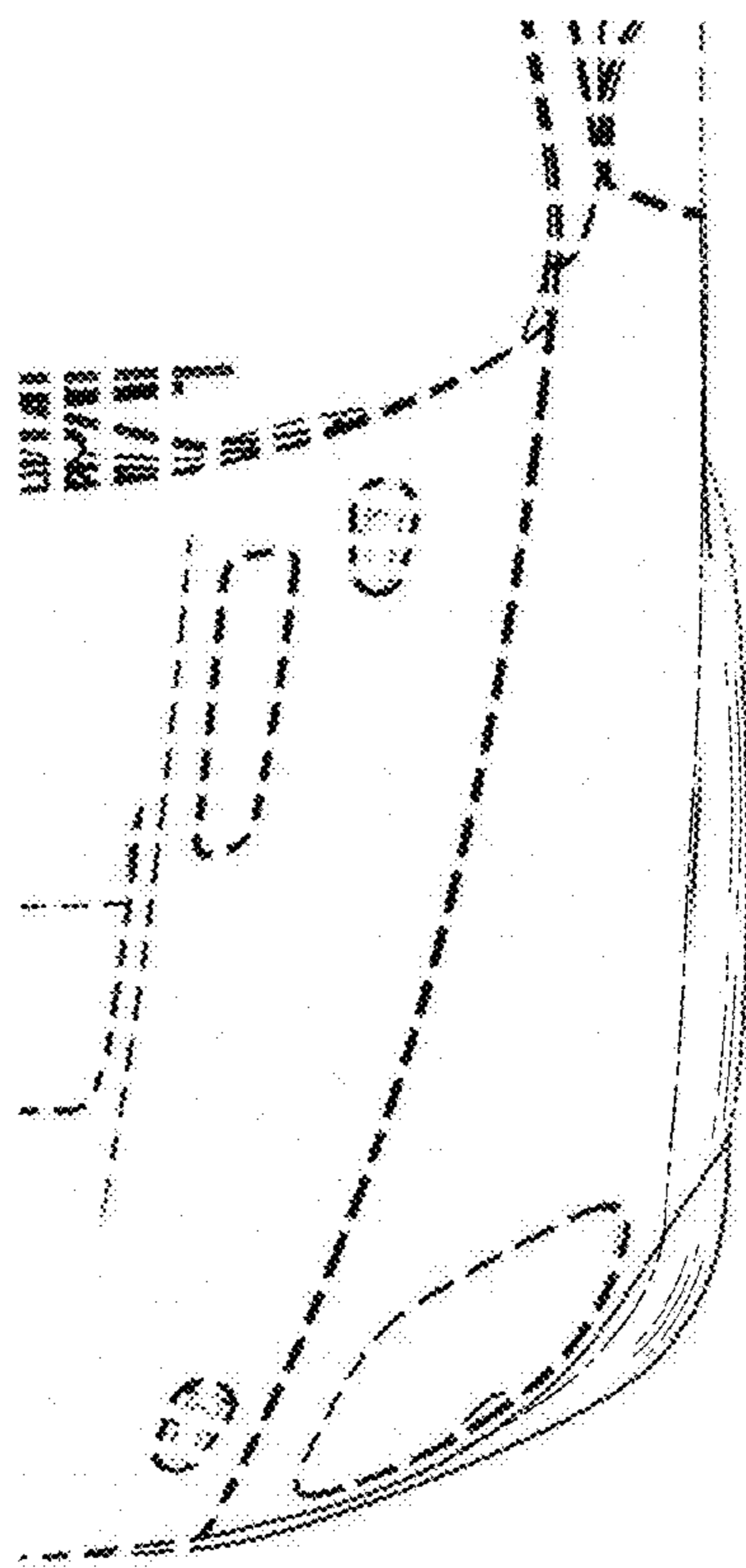

Fig. 6