



US00D855479S

(12) **United States Design Patent** (10) **Patent No.:** **US D855,479 S**
Charrier (45) **Date of Patent:** **** Aug. 6, 2019**

- (54) **WATCH CASE**
- (71) Applicant: **Richemont International SA,**
Villars-sur-Glane (CH)
- (72) Inventor: **Alix Charrier,** Avallon (FR)
- (73) Assignee: **Richemont International SA,**
Villars-sur-Glane (CH)
- (**) Term: **15 Years**
- (21) Appl. No.: **29/645,868**
- (22) Filed: **Apr. 30, 2018**
- (51) **LOC (12) Cl.** **10-02**
- (52) **U.S. Cl.**
USPC **D10/30**
- (58) **Field of Classification Search**
USPC D10/1-2, 6, 10, 30-39, 40-41, 102-103,
D10/122-129, 132; D11/3; D14/344,
D14/440
CPC G04B 37/00; G04B 37/005; G04B 37/22;
G04B 17/00; G04B 19/223; G04B 19/24;
G04B 45/00; G04B 45/0061; G04B
45/0069; G04B 45/0076; G04B 45/0084;
A45C 11/10; A45C 11/12; A45C 13/008
See application file for complete search history.

- (56) **References Cited**
U.S. PATENT DOCUMENTS
- | | | | | | |
|------------|---|---------|------------|-------|--------|
| D386,421 S | * | 11/1997 | Kennedy | | D10/30 |
| D390,148 S | * | 2/1998 | Brzezinski | | D10/30 |
| D452,175 S | * | 12/2001 | Finazzi | | D10/39 |
| D530,628 S | * | 10/2006 | Raffy | | D10/32 |
| D544,372 S | * | 6/2007 | Seyr | | D10/32 |

- | | | | | | |
|------------|---|---------|------------|-------|---------|
| D547,677 S | * | 7/2007 | Kume | | D10/38 |
| D555,520 S | * | 11/2007 | Strasser | | D10/39 |
| D591,178 S | * | 4/2009 | Magada | | D10/38 |
| D649,069 S | * | 11/2011 | Galli | | D10/30 |
| D675,942 S | * | 2/2013 | Giannini | | D10/33 |
| D690,611 S | * | 10/2013 | Inoue | | D10/39 |
| D725,493 S | * | 3/2015 | Rimanelli | | D10/30 |
| D756,239 S | * | 5/2016 | Delhotal | | D10/30 |
| D762,494 S | * | 8/2016 | Galli | | D10/126 |
| D786,705 S | * | 5/2017 | Babcock | | D10/30 |
| D802,446 S | * | 11/2017 | El Alej | | D10/30 |
| D814,947 S | * | 4/2018 | Emmenegger | | D10/39 |
| D816,517 S | * | 5/2018 | Emmenegger | | D10/39 |
| D821,254 S | * | 6/2018 | McKean | | D11/80 |
| D827,453 S | * | 9/2018 | Davoli | | D10/37 |

* cited by examiner

Primary Examiner — Sandra S Snapp
Assistant Examiner — Katherine Glennon
(74) *Attorney, Agent, or Firm* — Taft Stettinius & Hollister LLP

(57) **CLAIM**
The ornamental design for a watch case, as shown and described.

DESCRIPTION

FIG. 1 is a front elevational view of a watch case showing my new design;
FIG. 2 is a rear elevational view thereof;
FIG. 3 is a right side elevational view thereof;
FIG. 4 is a left side elevational view thereof;
FIG. 5 is a bottom plan view thereof;
FIG. 6 is a top plan view thereof;
FIG. 7 is a front, right side perspective view thereof; and,
FIG. 8 is a rear, left side perspective view thereof.

1 Claim, 8 Drawing Sheets

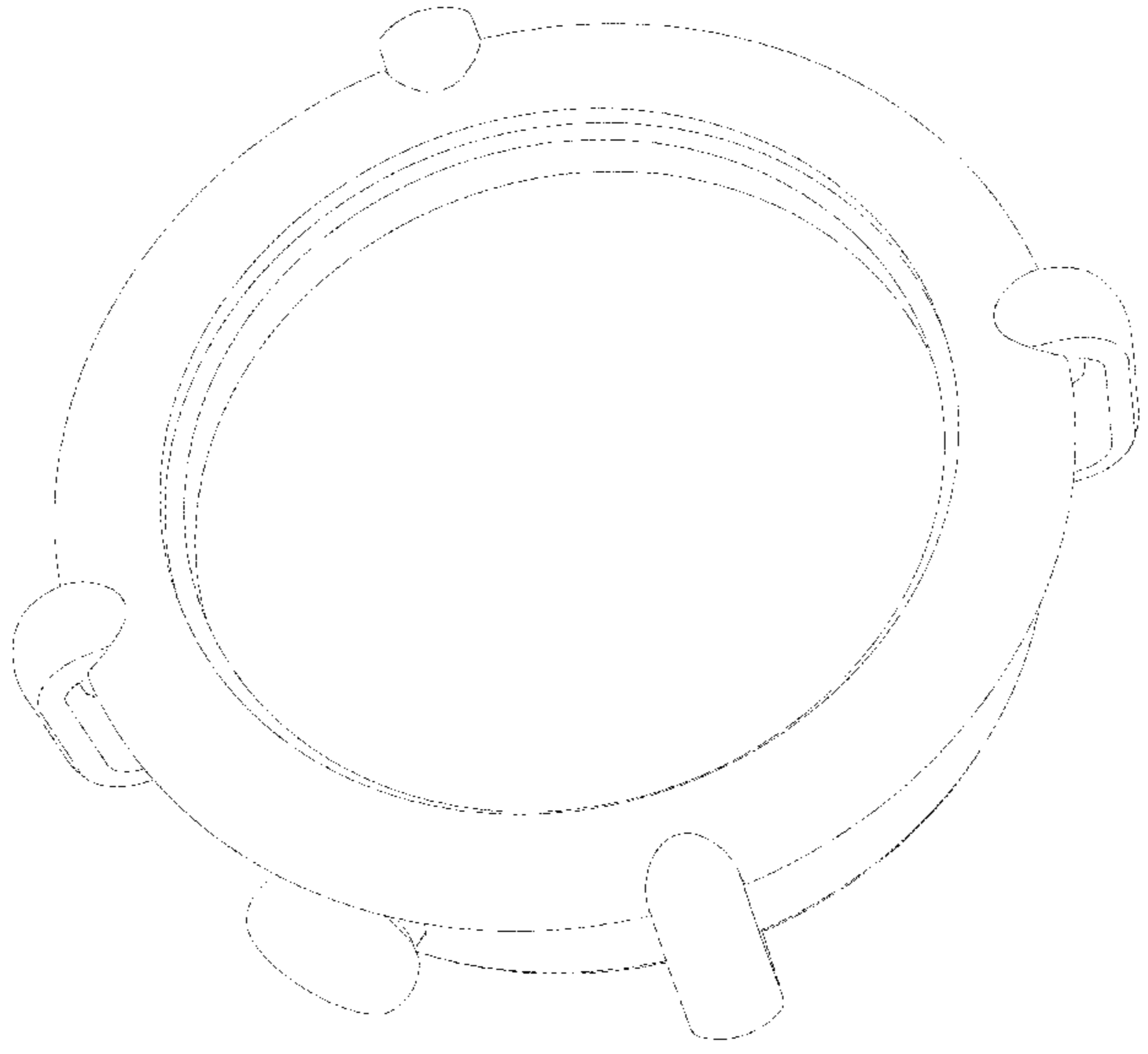

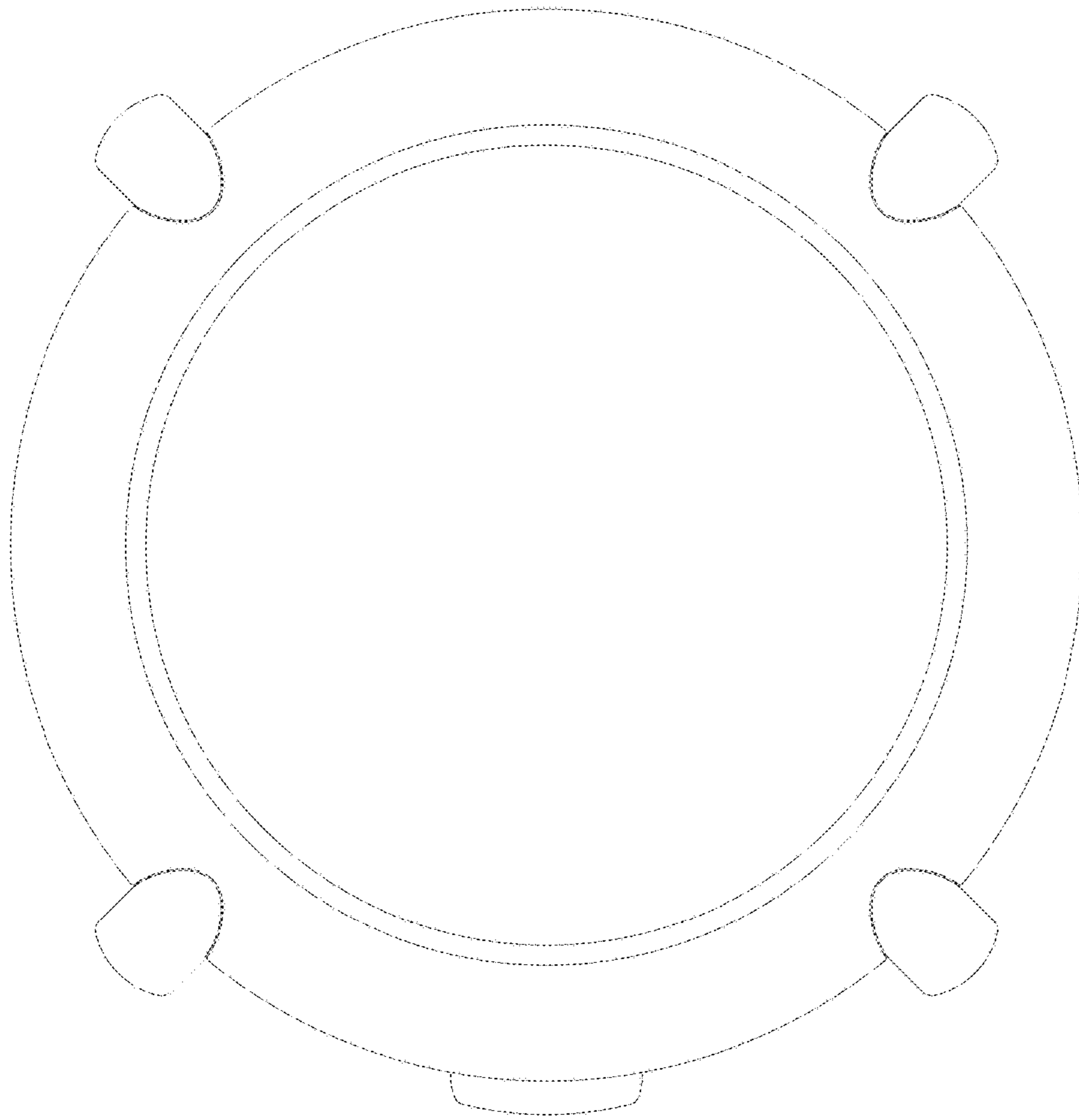

Fig. 1

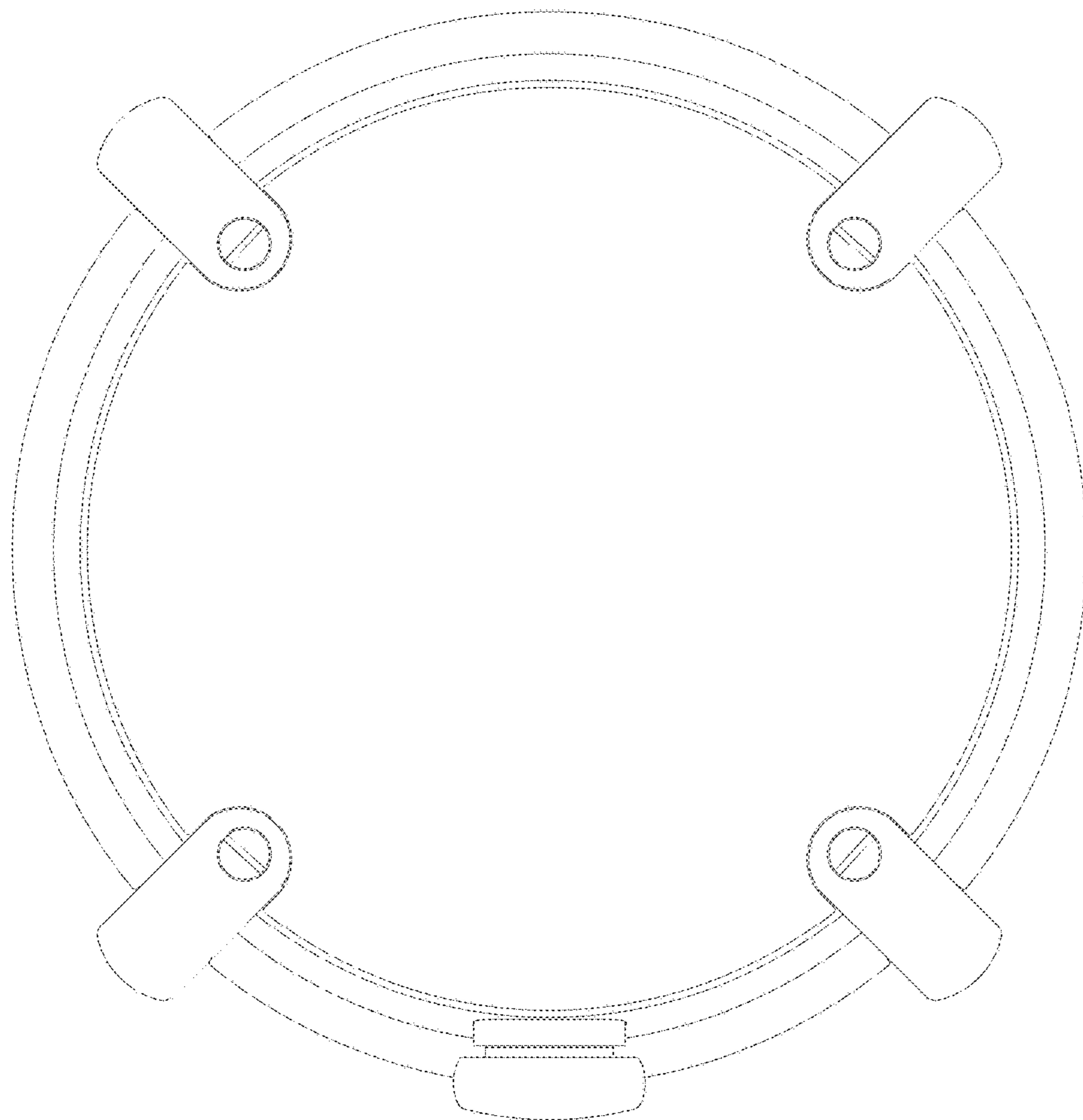

Fig. 2

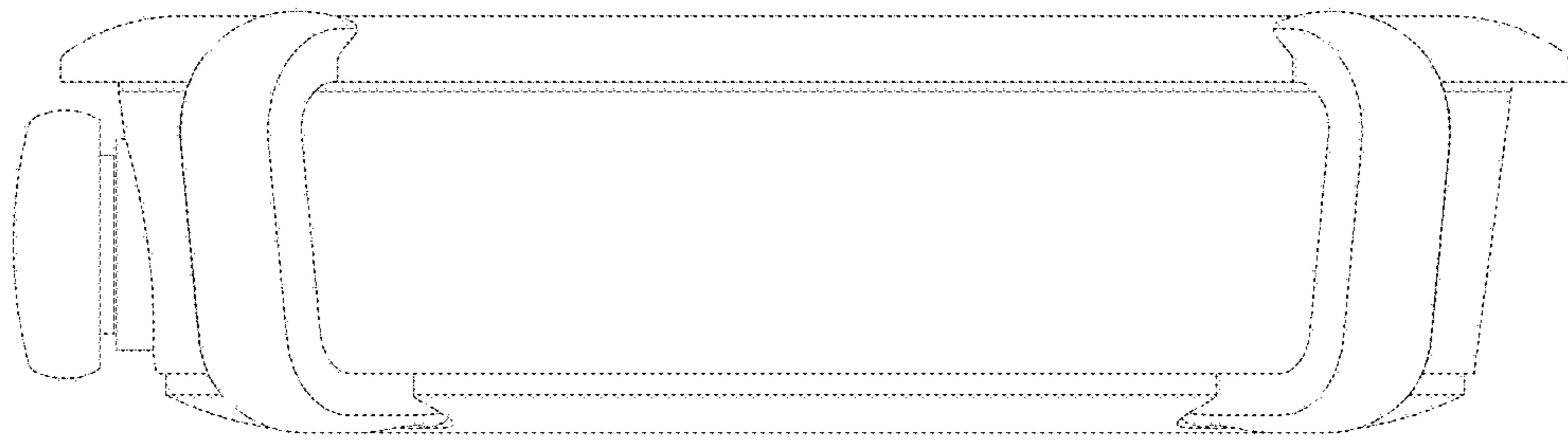

Fig. 3

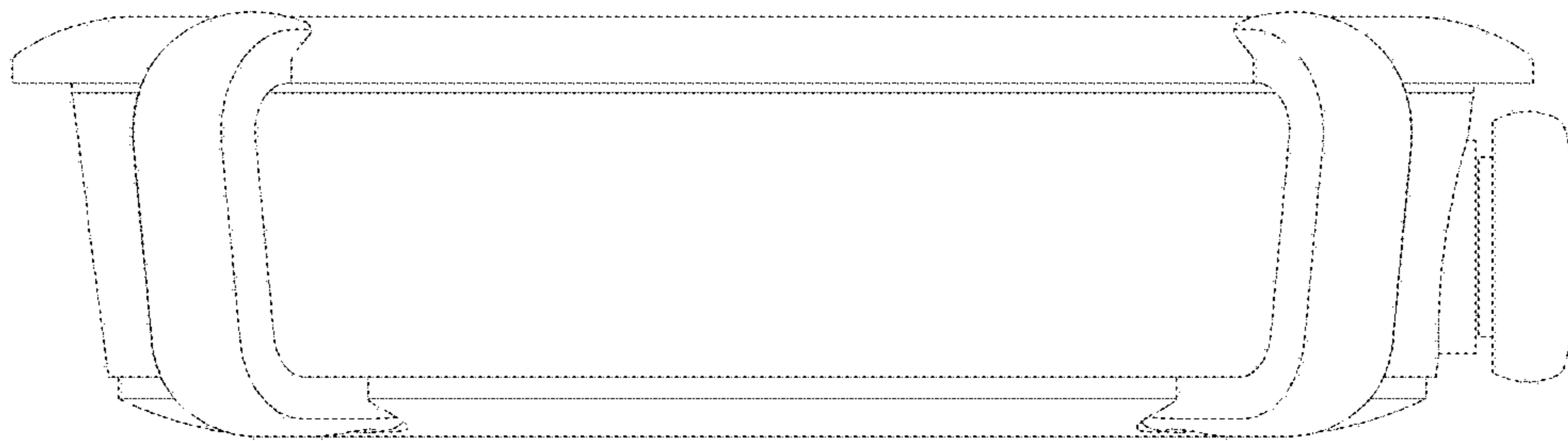

Fig. 4

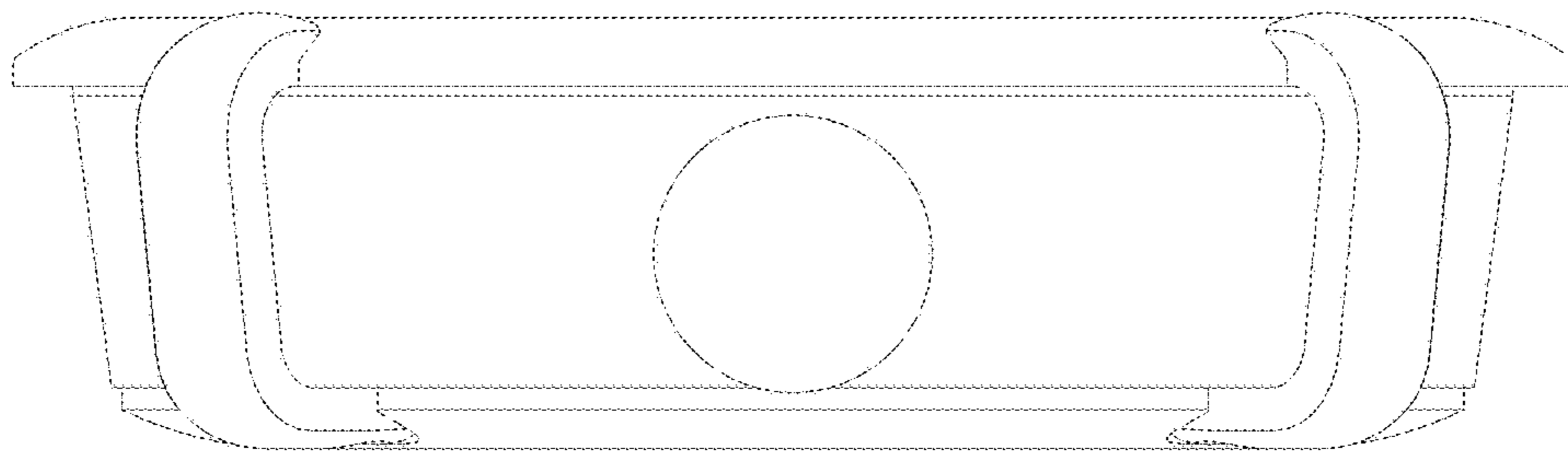

Fig. 5

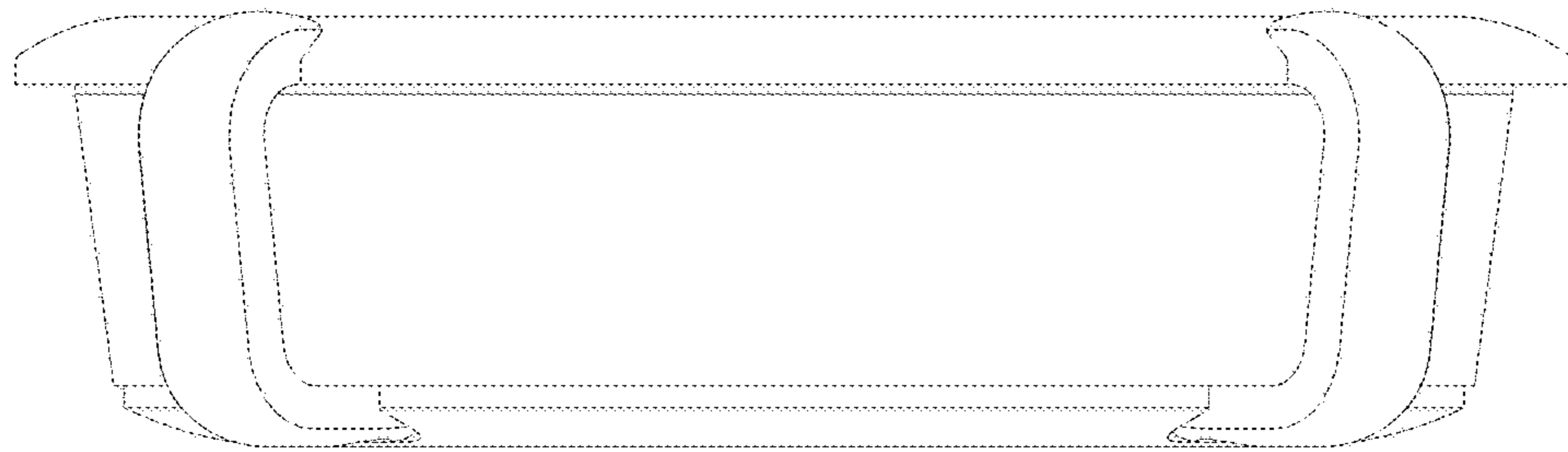

Fig. 6

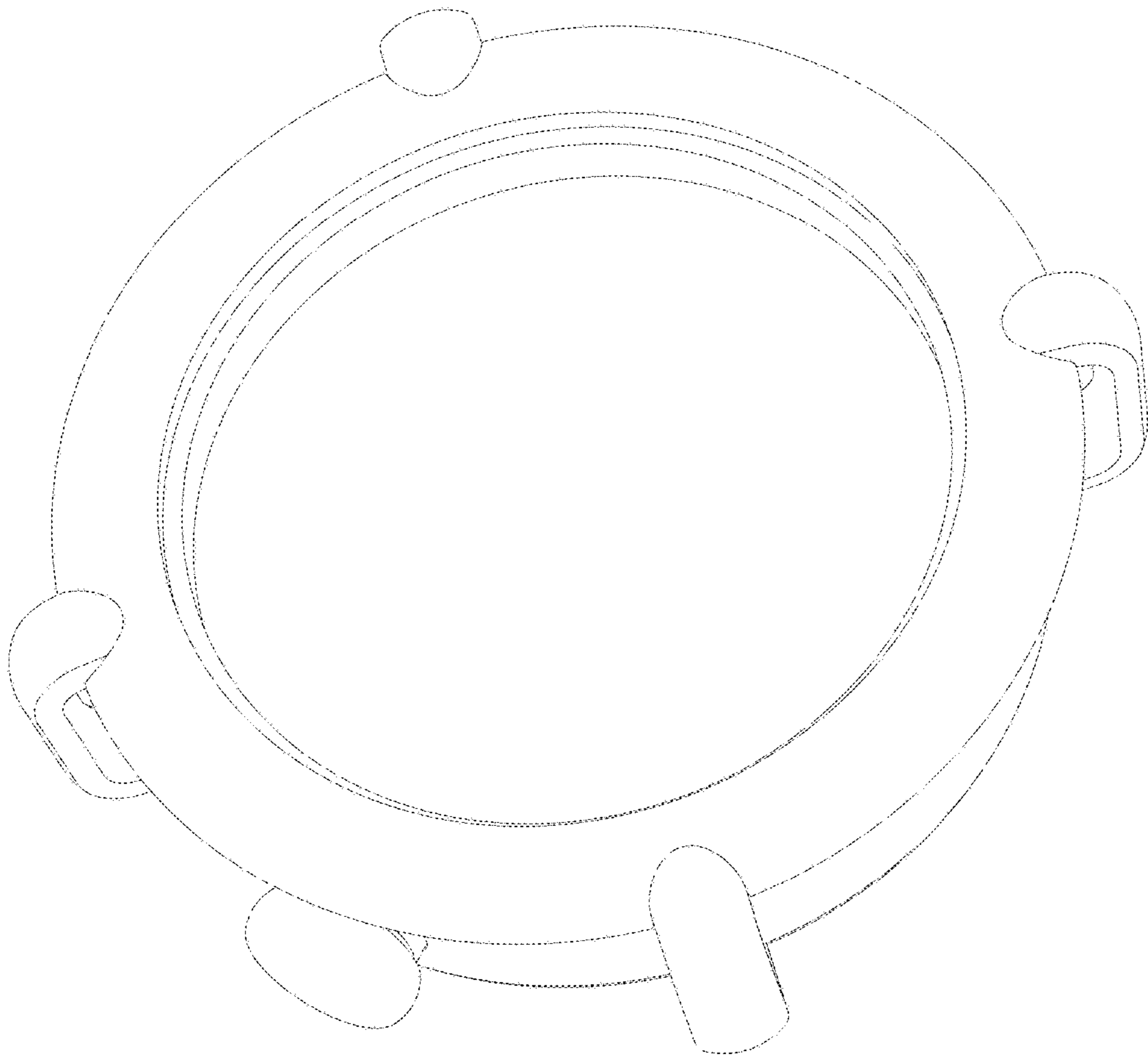

Fig. 7

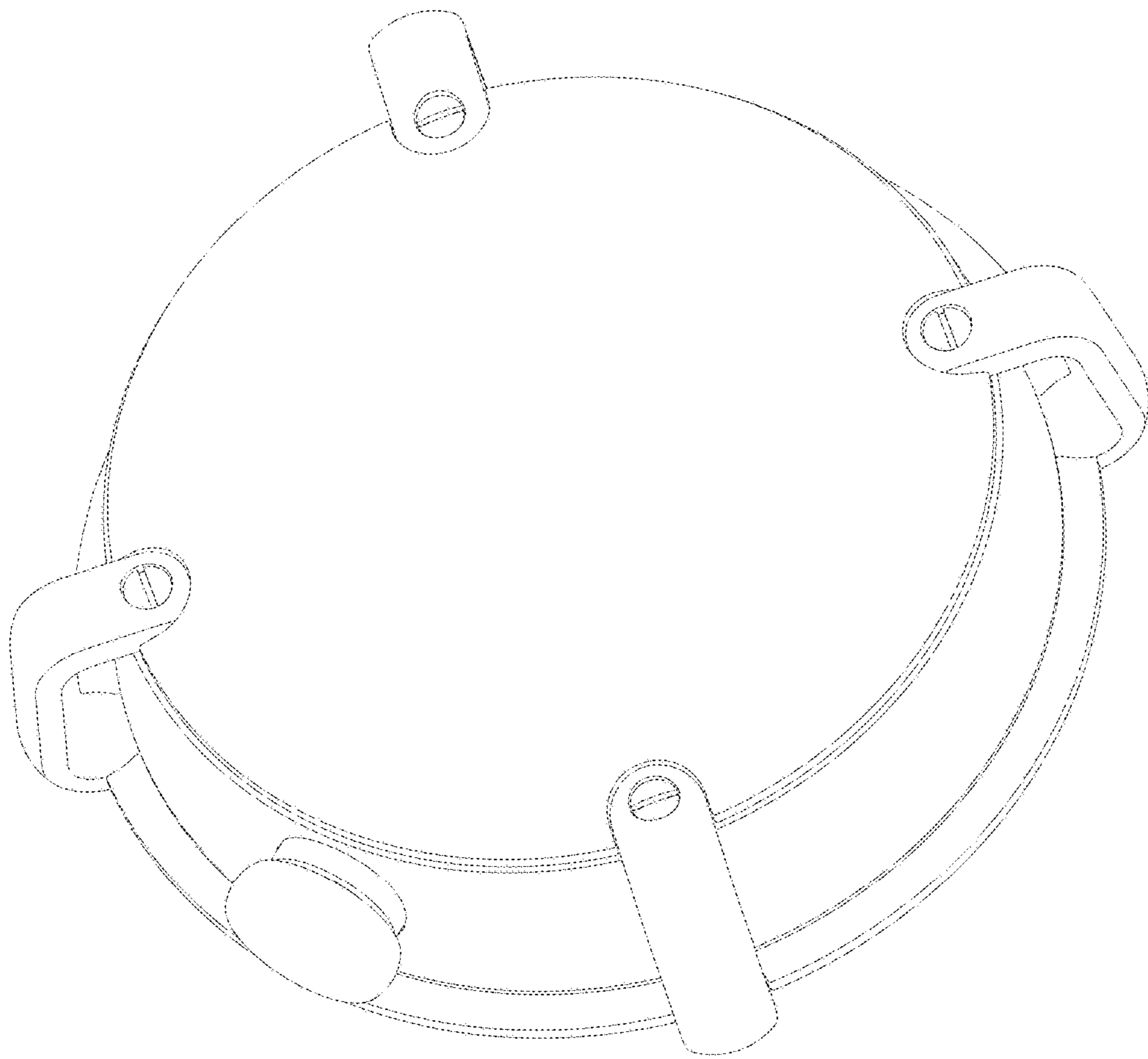

Fig. 8