



US00D855472S

(12) **United States Design Patent**
Scheffler

(10) **Patent No.:** **US D855,472 S**
(45) **Date of Patent:** **** Aug. 6, 2019**

(54) **BOTTLE WITH CAP AND
OPENING-CLOSURE SYSTEM**

(71) Applicant: **SPI Group S.à.r.l.**, Luxembourg (LU)

(72) Inventor: **Yuri Scheffler**, Crans-Montana (CH)

(73) Assignee: **SPI GROUP S.À.R.L.**, Luxembourg (LU)

(**) Term: **15 Years**

(21) Appl. No.: **29/609,630**

(22) Filed: **Jul. 3, 2017**

(30) **Foreign Application Priority Data**

Apr. 25, 2017 (MX) MX/f/2017/001175

(51) **LOC (12) Cl.** **09-01**

(52) **U.S. Cl.**
USPC **D9/563; D9/443; D9/575**

(58) **Field of Classification Search**
USPC D9/439, 443, 516, 520, 521, 544, 546,
D9/559, 560, 561, 563, 564, 567,
D9/572-575, 715, 719

CPC . B65D 21/0204; B65D 21/02; B65D 21/0213
See application file for complete search history.

(56) **References Cited**

U.S. PATENT DOCUMENTS

200,991 A	3/1878	Dietz
206,341 A	7/1878	Martin
301,599 A	7/1884	Hunt
314,025 A	3/1885	Hoyt
D17,215 S	3/1887	Park
D19,052 S	4/1889	Van Houten
D20,026 S	7/1890	Bentley
D21,192 S	12/1891	Van Houten
599,269 A	2/1898	Stadel
640,897 A	1/1900	Fowler
D34,996 S	8/1901	Brawner

719,515 A	2/1903	Schiefer
815,902 A	3/1906	Cardell
823,437 A	6/1906	Peterson
913,214 A	2/1909	Peterson
945,842 A	1/1910	Fagerdtroem et al.

(Continued)

OTHER PUBLICATIONS

European Union Intellectual Property Office Certificate Registration
No. 003864081-0001, registered Apr. 20, 2017.

(Continued)

Primary Examiner — Ian Simmons

Assistant Examiner — Keith Frank

(74) *Attorney, Agent, or Firm* — Wenderoth, Lind &
Ponack, L.L.P.

(57) **CLAIM**

The ornamental design for a bottle with cap, as shown and described.

DESCRIPTION

FIG. 1 is a perspective view of a bottle with cap;
FIG. 2 is a front view of FIG. 1;
FIG. 3 is a rear view of FIG. 1;
FIG. 4 is a side view of FIG. 1;
FIG. 5 is a side view of FIG. 1;
FIG. 6 is a top view of FIG. 1;
FIG. 7 is a bottom view of FIG. 1;
FIG. 8 is a perspective view of the bottle with cap of FIG. 1, with logo elements on the bottom, side, and opening-closure system;
FIG. 9 is a front view of FIG. 8;
FIG. 10 is a rear view of FIG. 8;
FIG. 11 is a side view of FIG. 8;
FIG. 12 is a side view of FIG. 8;
FIG. 13 is a top view of FIG. 8; and,
FIG. 14 is a bottom view of FIG. 8.

1 Claim, 14 Drawing Sheets

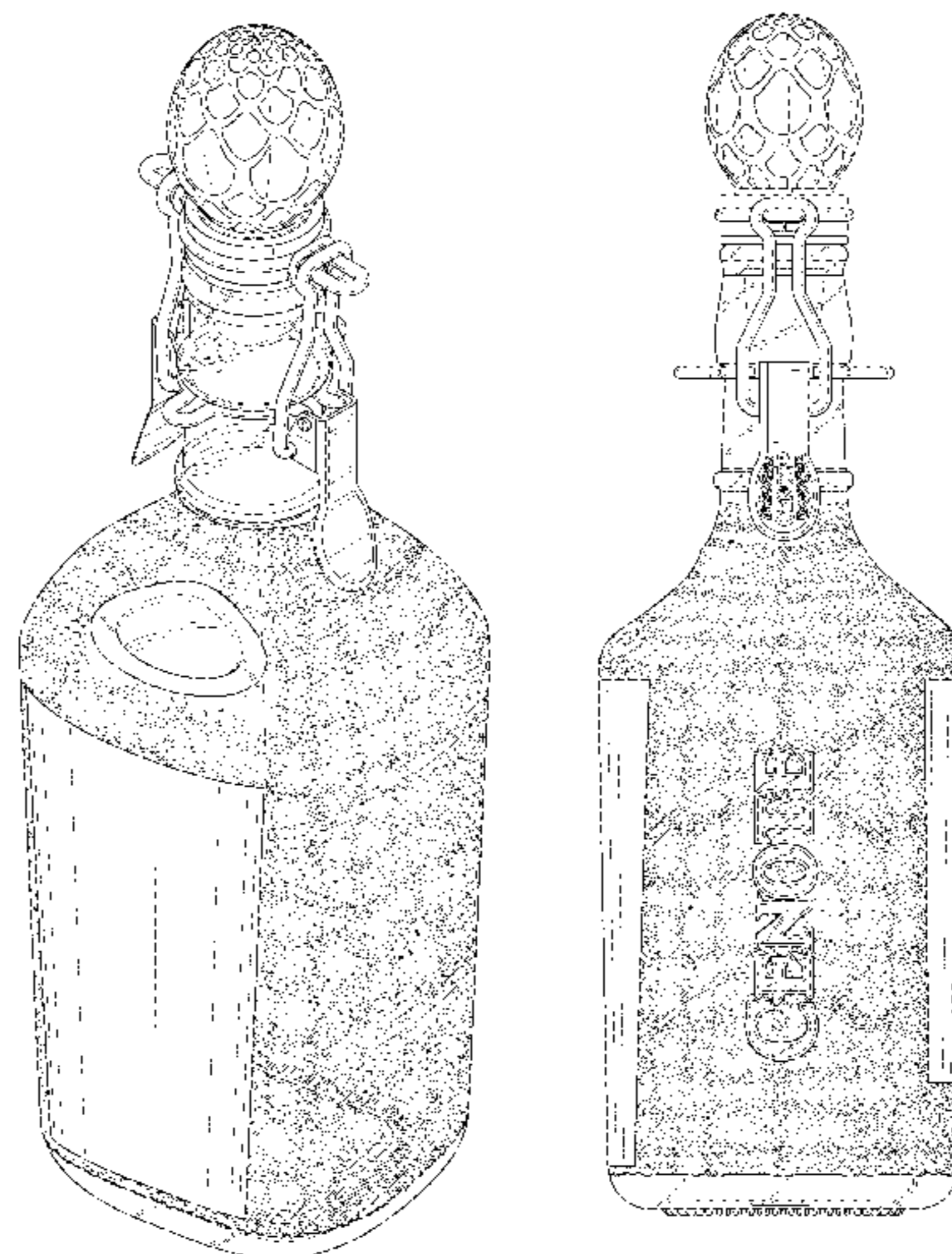

(56)

References Cited

U.S. PATENT DOCUMENTS

946,334 A 1/1910 Cardell
 1,011,198 A 12/1911 Holmes
 1,109,570 A 9/1914 Fulmer et al.
 1,298,128 A 3/1919 White
 1,330,966 A 2/1920 White
 1,348,808 A 8/1920 Kivlan
 1,383,215 A 6/1921 Kivlan
 1,420,892 A 6/1922 Thompson
 D62,311 S 5/1923 Schoenbrun
 1,519,988 A 12/1924 Clark
 D70,957 S 8/1926 Guerin
 D71,125 S 9/1926 Becker
 D74,894 S 4/1928 Onthank
 D80,729 S 3/1930 Huret
 D83,658 S * 3/1931 Baxter D9/546
 D98,040 S 12/1935 Lewis
 2,096,098 A 10/1937 Fraysur
 D166,477 S 4/1952 Margolis
 D186,971 S 12/1959 Chakine
 D192,826 S 5/1962 Du Pree
 4,175,668 A 11/1979 Hebert
 D270,614 S 9/1983 Desgrippes
 D275,368 S * 9/1984 du Chambon D9/520
 D277,079 S * 1/1985 Wirkkala D9/531
 D292,371 S * 10/1987 Cooper D9/561
 D307,545 S 5/1990 Hibbert
 D325,345 S 4/1992 Holland
 D335,444 S 5/1993 Marchini
 D342,903 S 1/1994 Ricci
 D415,414 S * 10/1999 Pekarev D9/652
 D423,935 S * 5/2000 Frazer D9/520
 D472,469 S 4/2003 Versace
 D486,072 S * 2/2004 Potocki D9/567

D562,150 S 2/2008 Gamarra
 D619,470 S 7/2010 Zeidan
 D646,178 S * 10/2011 Barber D9/560
 D653,558 S * 2/2012 Kania D9/560
 D678,063 S * 3/2013 Dubow D7/628
 D684,065 S * 6/2013 Wiseman D9/500
 D707,565 S * 6/2014 Villasol D9/520
 D734,163 S * 7/2015 Infahsaeng D9/500
 D739,756 S * 9/2015 Manley D9/544
 D739,760 S * 9/2015 Manley D9/544
 D742,754 S * 11/2015 Roth D9/439
 9,254,057 B1 2/2016 McGinn
 9,332,867 B2 5/2016 Chase et al.
 D784,146 S * 4/2017 Notheis D7/511
 D794,460 S * 8/2017 Notheis D9/443
 D815,543 S * 4/2018 Mazzer D9/611
 D818,361 S * 5/2018 Kaiser D9/435
 D825,338 S * 8/2018 Manley D9/516
 2015/0060459 A1 3/2015 Wu

OTHER PUBLICATIONS

European Union Intellectual Property Office Certificate of Registration No. 003871169-0001, registered Apr. 25, 2017.
 European Union Intellectual Property Office Certificate of Registration No. 003871722-0001, registered Apr. 25, 2017.
 European Union Intellectual Property Office Certificate of Registration No. 003872662-0001, registered Apr. 25, 2017.
 European Union Intellectual Property Office Certificate of Registration No. 003872696-0001, registered Apr. 25, 2017.
 European Union Intellectual Property Office Certificate of Registration No. 003872829-0001, registered Apr. 25, 2017.
 European Union Intellectual Property Office Certificate of Registration No. 004026078-0001, registered May 31, 2017.

* cited by examiner

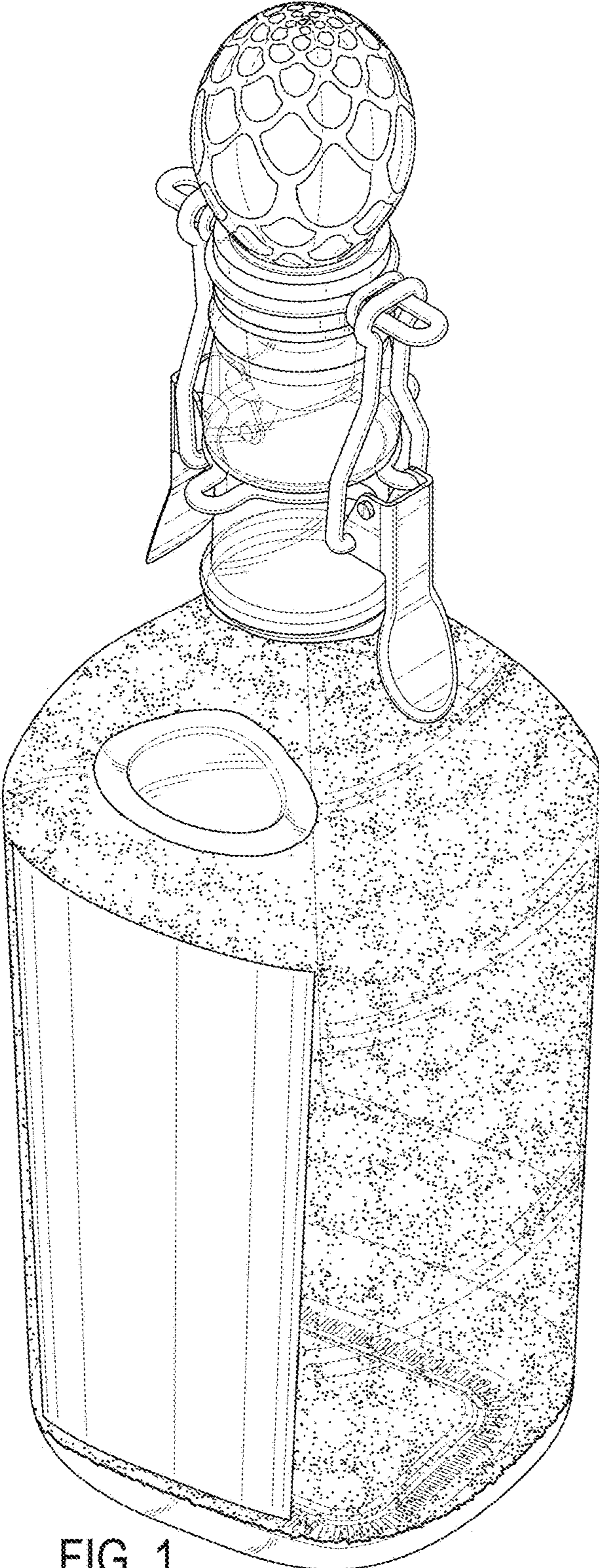

FIG. 1

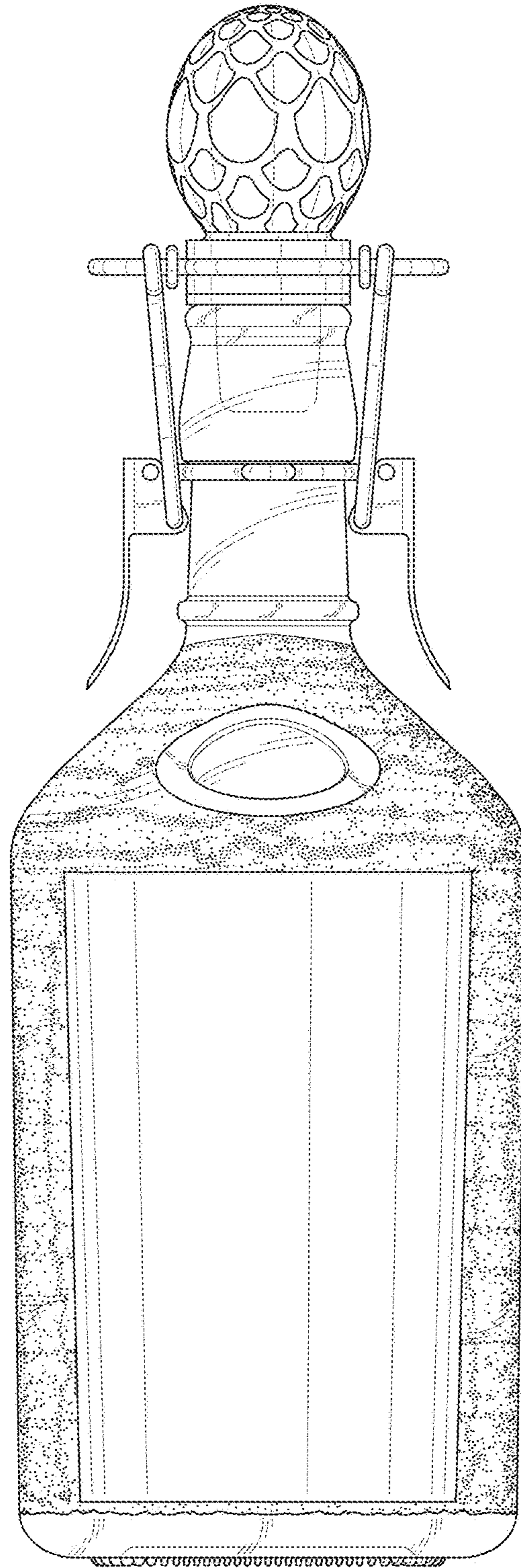

FIG. 2

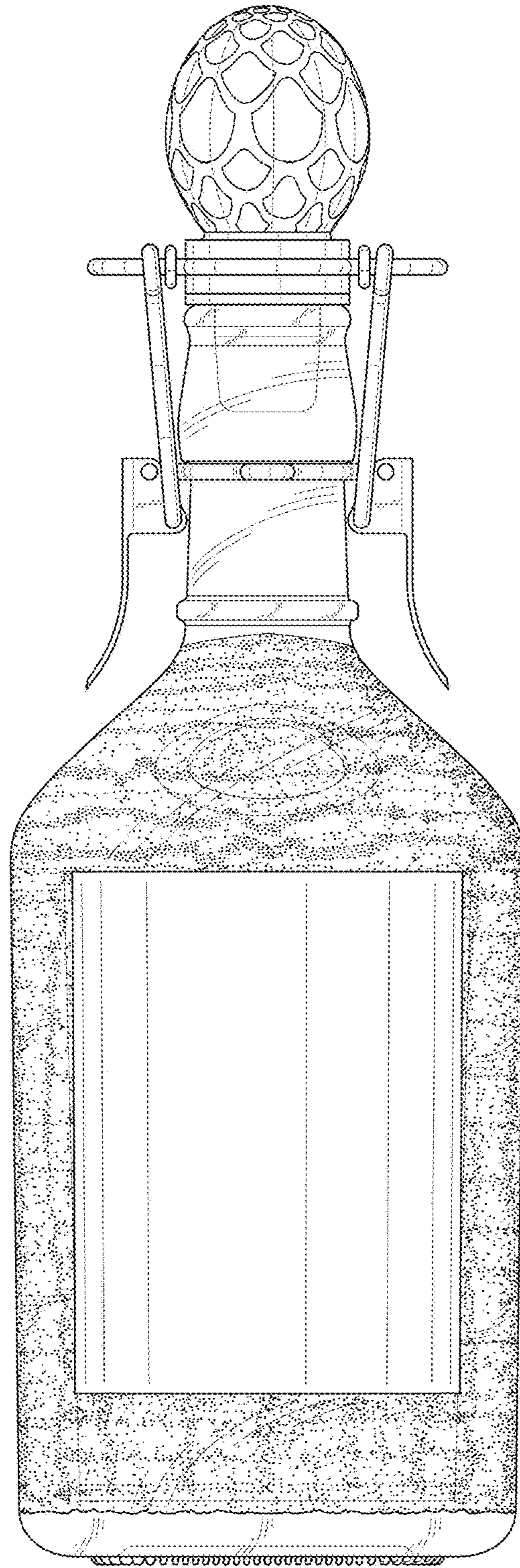

FIG. 3

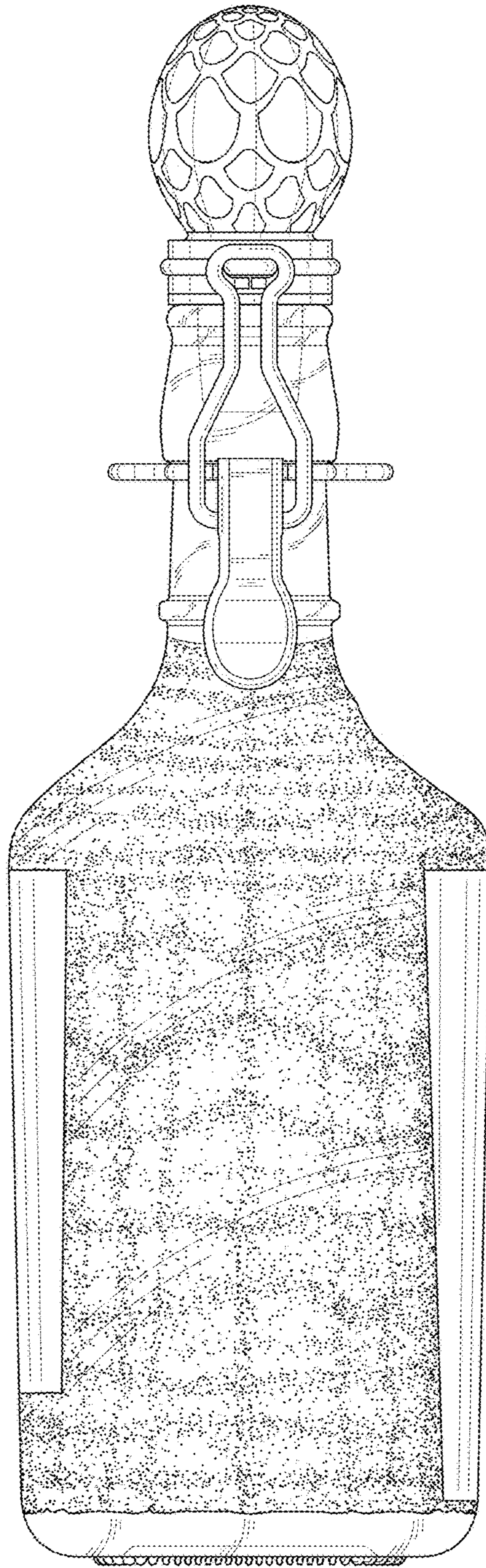

FIG. 4

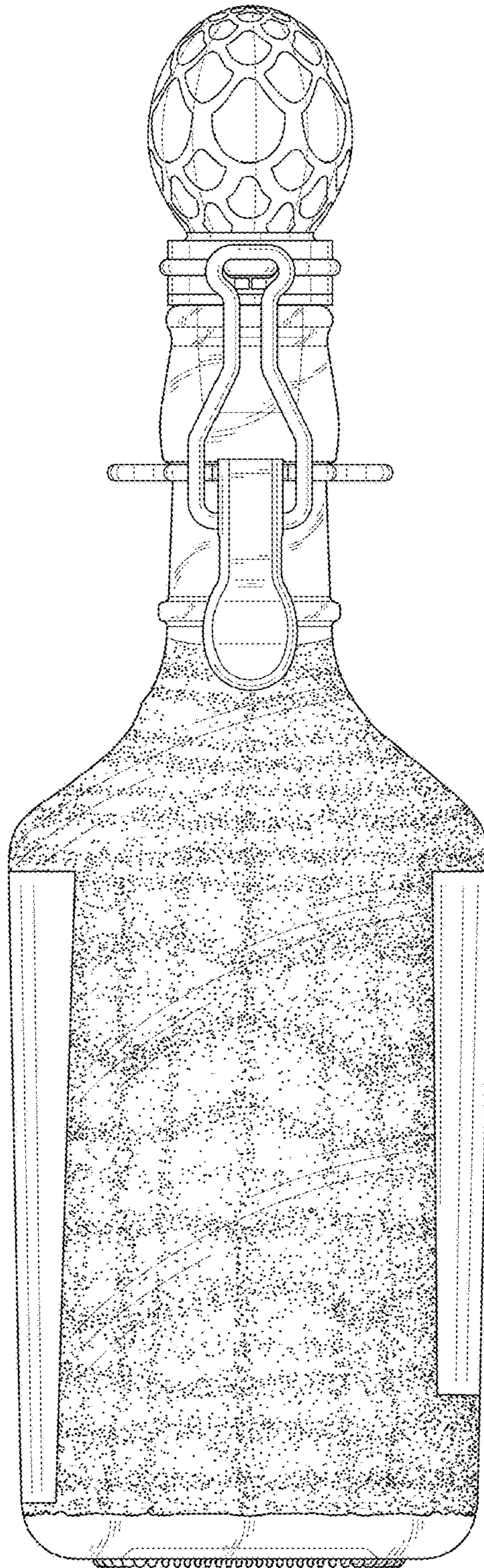

FIG. 5

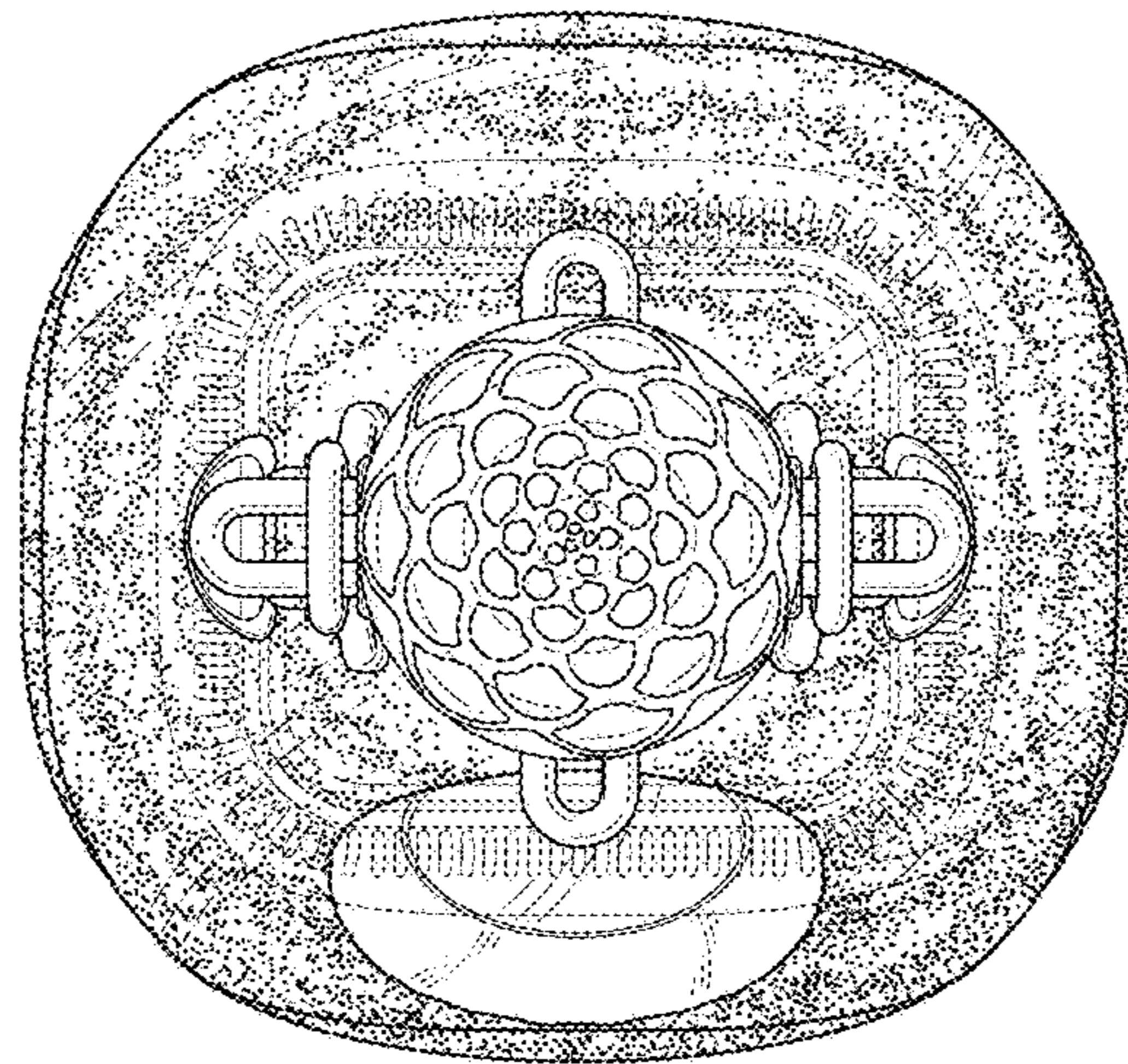

FIG. 6

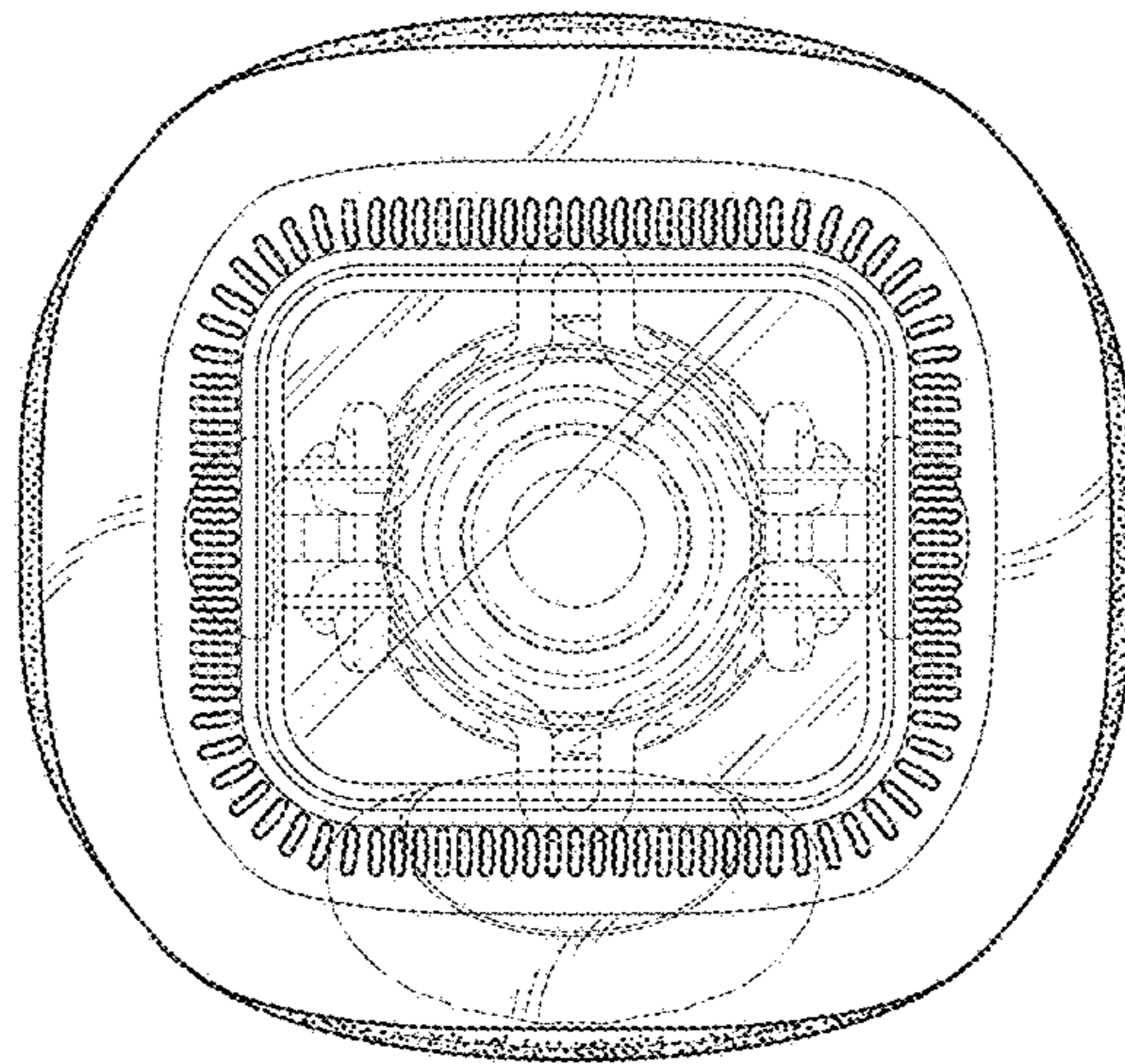

FIG. 7

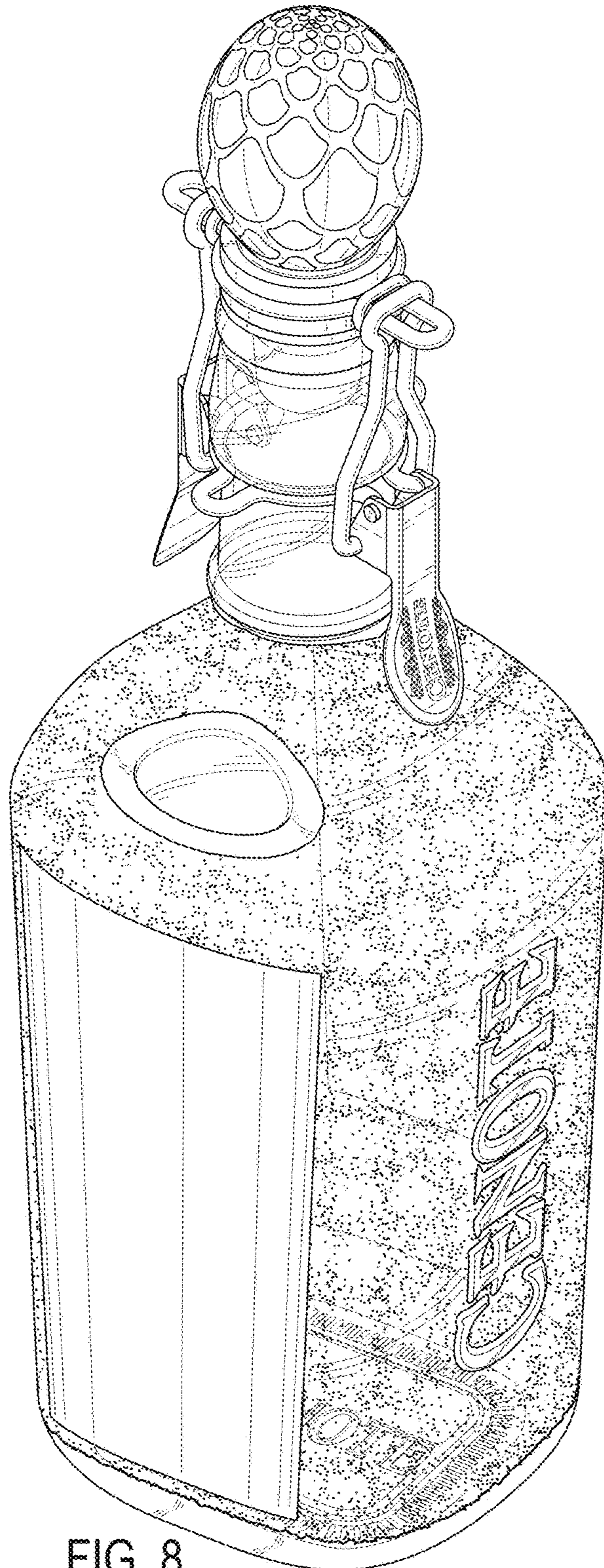

FIG. 8

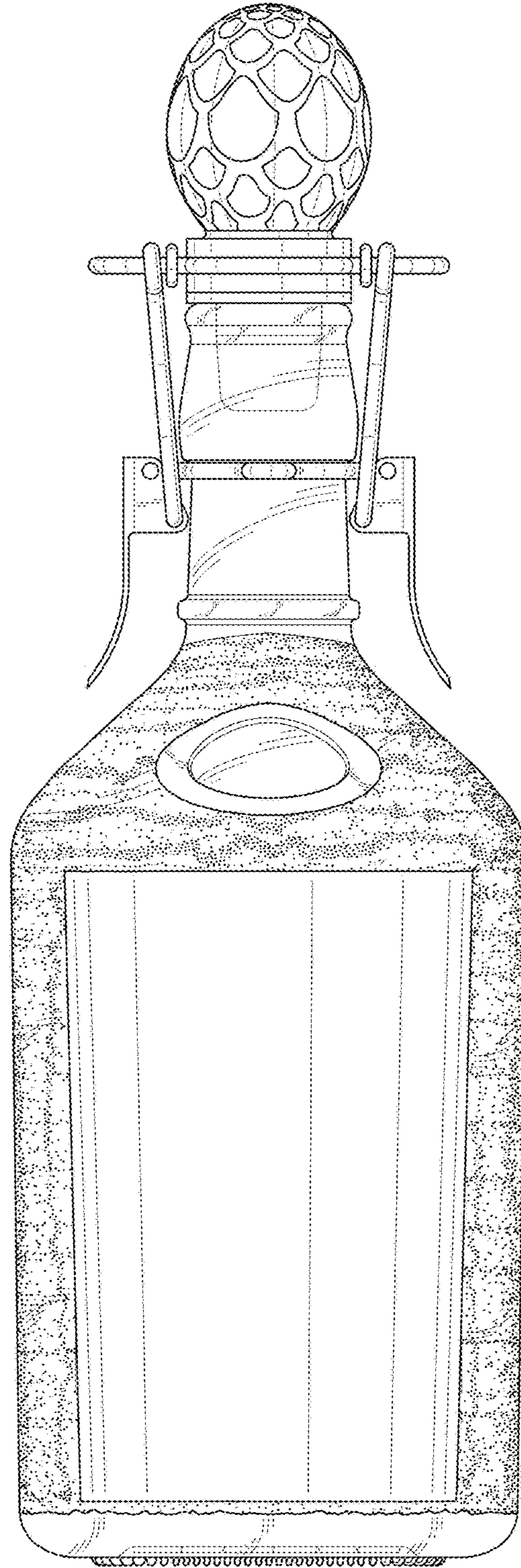

FIG. 9

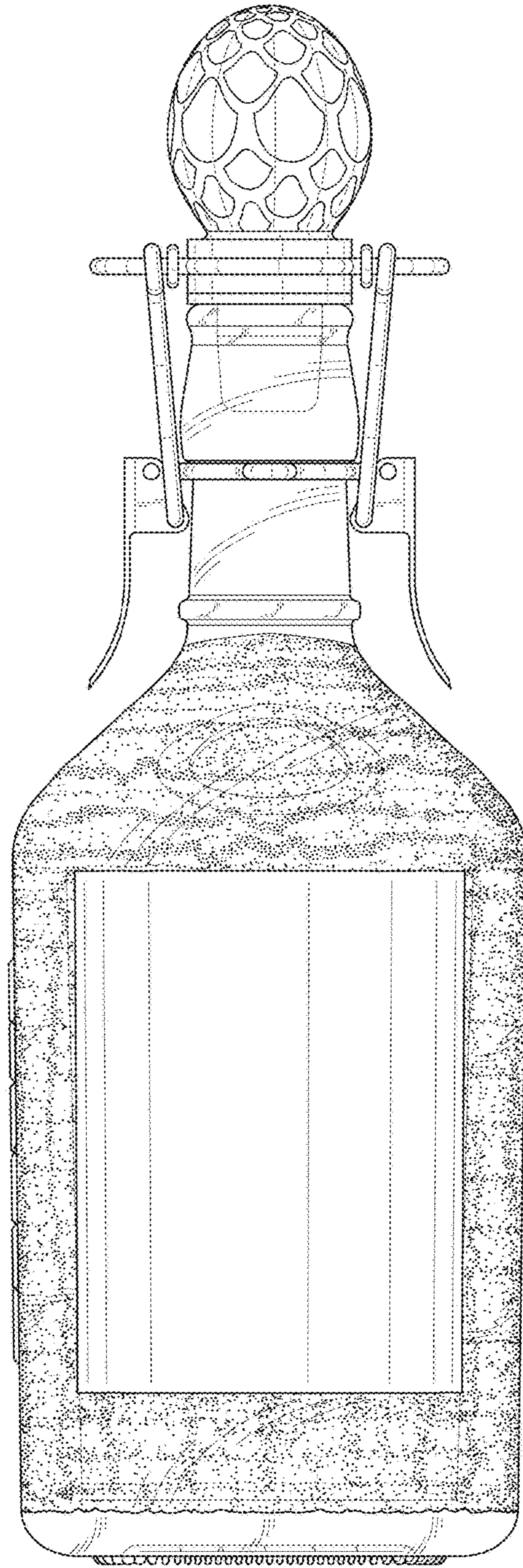

FIG. 10

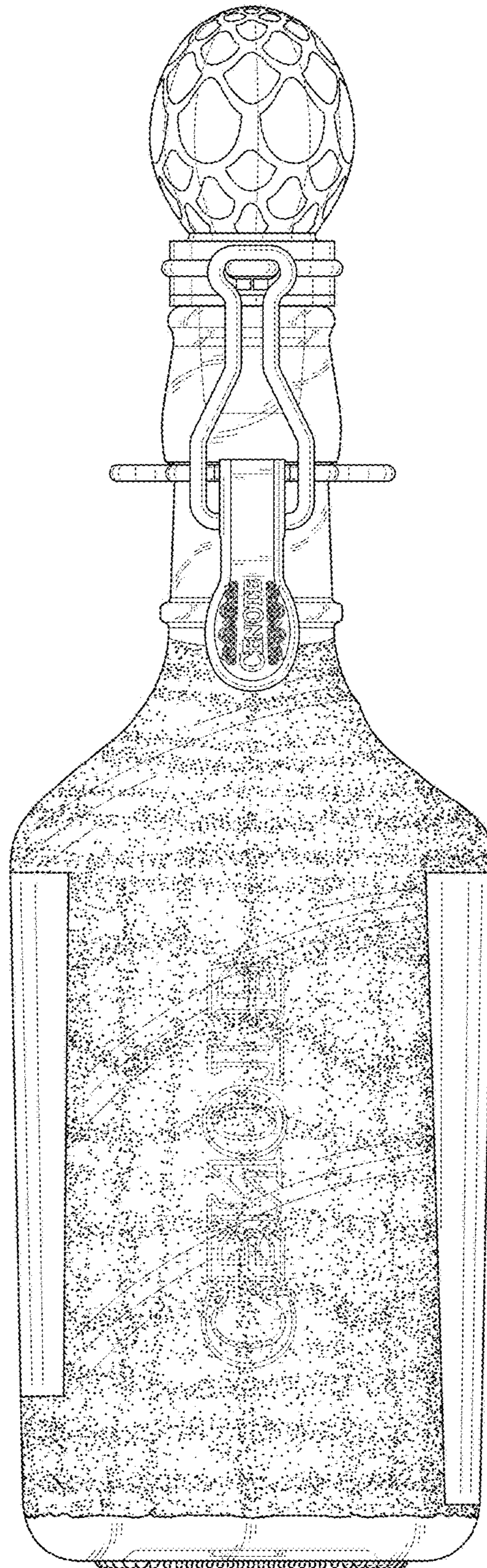

FIG. 11

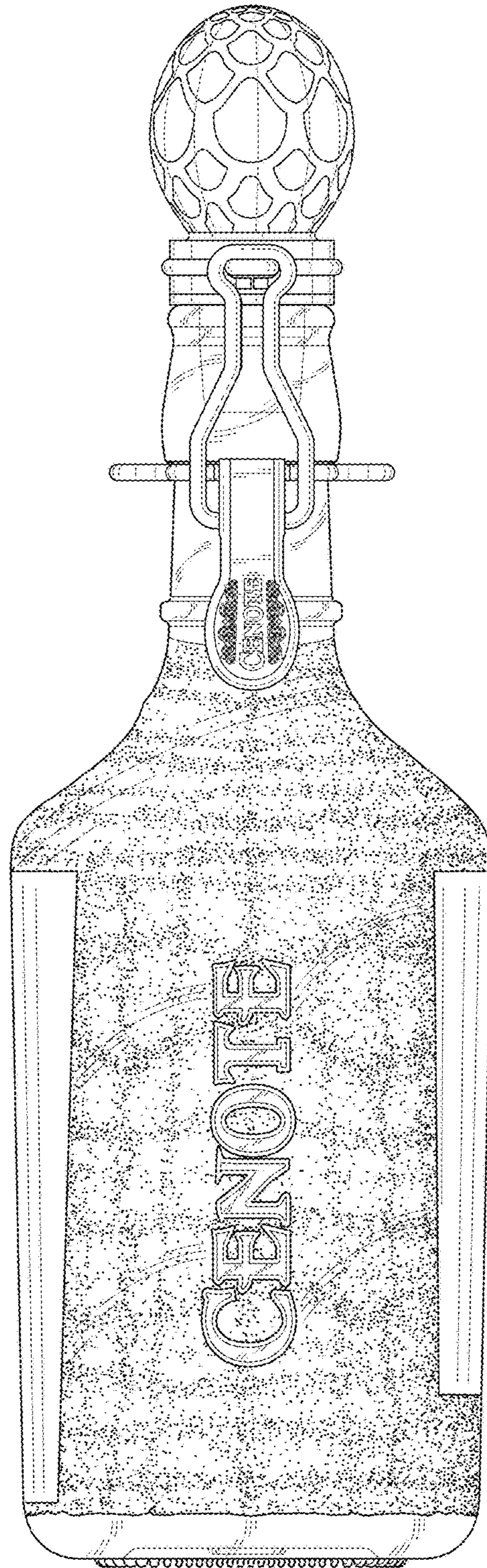

FIG. 12

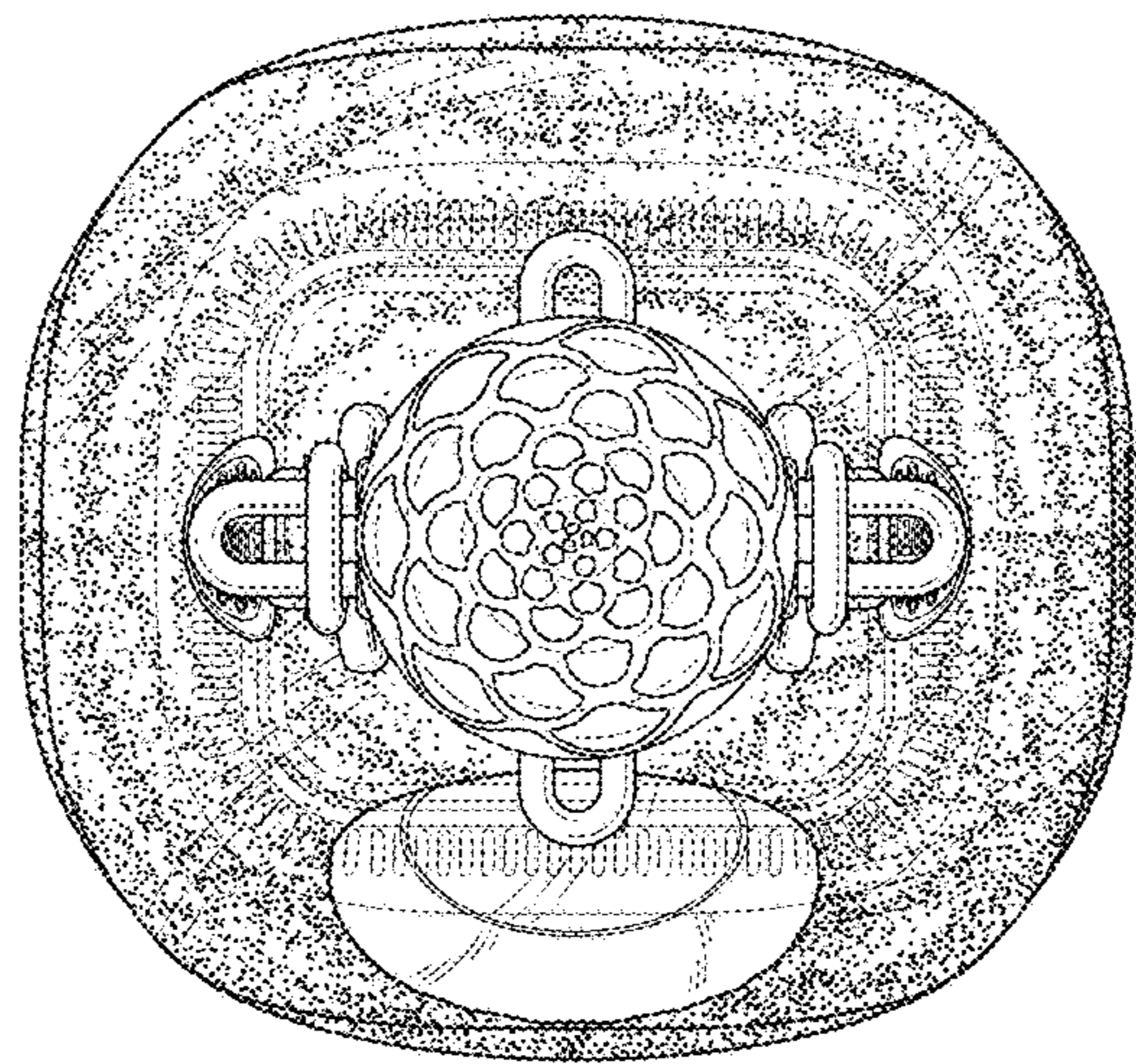

FIG. 13

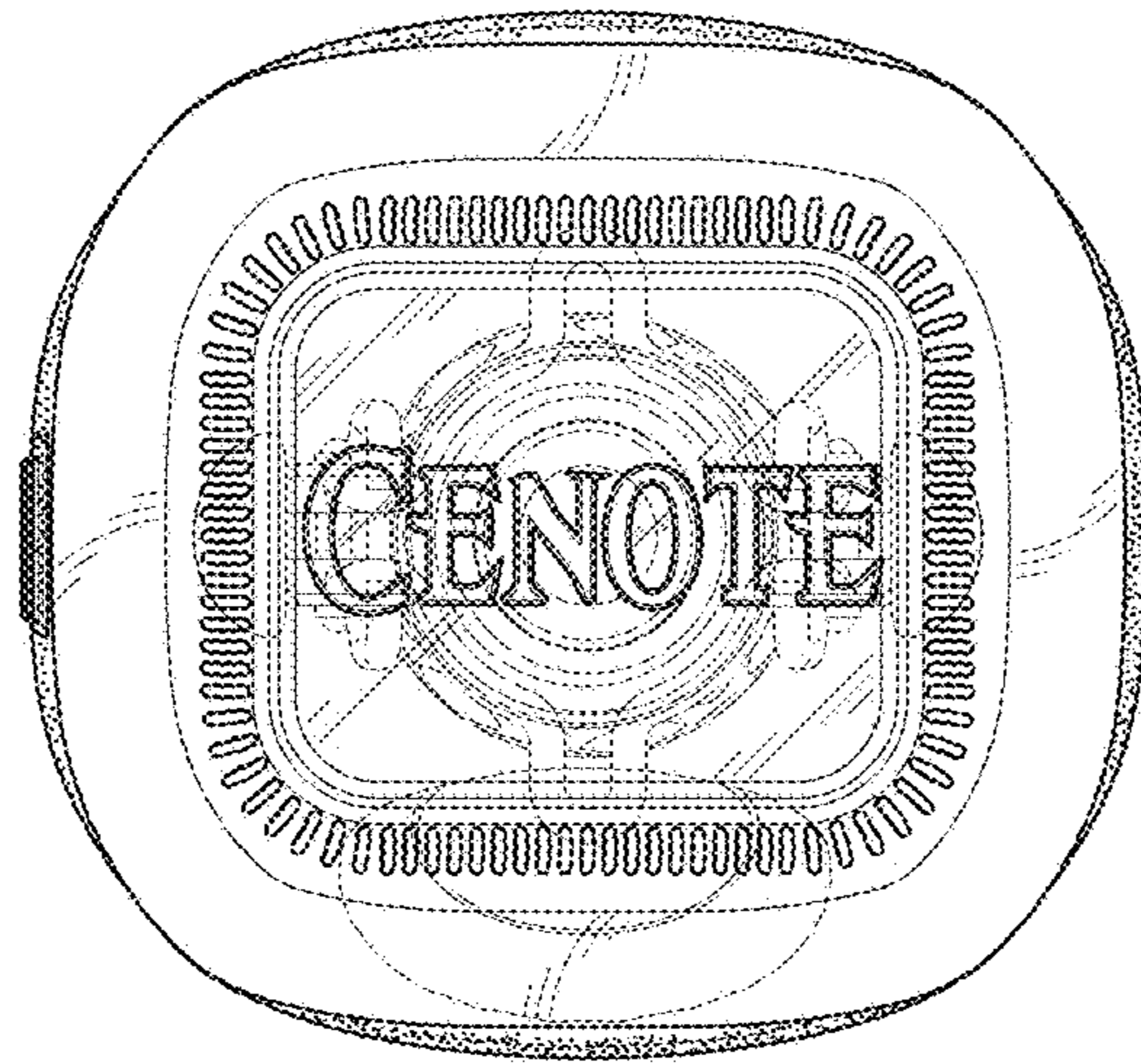

FIG. 14