



US00D855471S

(12) **United States Design Patent**  
**Kim**

(10) **Patent No.:** **US D855,471 S**

(45) **Date of Patent:** **\*\* Aug. 6, 2019**

(54) **COSMETIC VESSEL**

(71) Applicant: **LG HOUSEHOLD & HEALTH CARE LTD.**, Seoul (KR)

(72) Inventor: **Joung Eun Kim**, Seoul (KR)

(73) Assignee: **LG HOUSEHOLD & HEALTH CARE LTD.**, Seoul (KR)

(\*\*) Term: **15 Years**

(21) Appl. No.: **29/589,872**

(22) Filed: **Jan. 5, 2017**

(30) **Foreign Application Priority Data**

Dec. 8, 2016 (KR) ..... 30-2016-0059441

(51) **LOC (12) Cl.** ..... **09-01**

(52) **U.S. Cl.**  
USPC ..... **D9/529; D9/453; D9/454; D9/504;**  
**D9/551; D9/556; D9/558**

(58) **Field of Classification Search**  
USPC ..... **D9/434-435, 444-445, 449, 453-454,**  
**D9/500, 503-504, 516, 529, 549, 558,**  
**D9/715, 520, 548**

CPC ..... **B65D 1/00; B65D 1/02; B65D 1/0223;**  
**B65D 23/00; B65D 81/00; B65D**  
**2501/00; B65D 2501/009**

See application file for complete search history.

(56) **References Cited**

**U.S. PATENT DOCUMENTS**

D142,654 S \* 10/1945 Newport, Jr. .... D9/503  
D152,625 S \* 2/1949 Kronman ..... D9/453  
6,923,347 B2 \* 8/2005 Winckels ..... A45D 40/0068  
206/229  
D542,134 S \* 5/2007 Chadfield ..... D9/445

D578,393 S \* 10/2008 Canamasas Puigbo ..... D9/500  
D610,009 S \* 2/2010 Prufer ..... D9/504  
D618,557 S \* 6/2010 Jin ..... D9/545  
D621,708 S \* 8/2010 Thomas ..... D9/500  
D645,747 S \* 9/2011 Yu ..... D9/445  
D645,751 S \* 9/2011 Baek ..... D9/504  
D656,034 S \* 3/2012 Wanders ..... D9/428  
D695,116 S \* 12/2013 Ahn ..... D9/454  
D730,191 S \* 5/2015 Hardy ..... D9/454  
D773,628 S \* 12/2016 Gobber ..... D23/366  
D782,912 S \* 4/2017 Jeong ..... D28/4  
D793,236 S \* 8/2017 Santos ..... D9/454  
D806,546 S \* 1/2018 Lloyd ..... D9/451  
D814,301 S \* 4/2018 Weinrich ..... D9/503  
D817,174 S \* 5/2018 Weinrich ..... D9/503  
D817,178 S \* 5/2018 Jeong ..... D9/558  
D832,710 S \* 11/2018 Kim ..... D9/529

\* cited by examiner

*Primary Examiner* — Dana Meyrow

(74) *Attorney, Agent, or Firm* — Mintz Levin Cohn Ferris  
Glovsky and Popeo, P.C.; Kongsik Kim; Jhongwoo Jay  
Peck

(57) **CLAIM**

The ornamental design for a cosmetic vessel, as shown and described.

**DESCRIPTION**

FIG. 1 is a perspective view of a cosmetic vessel according to the present invention.

FIG. 2 is a front view of the cosmetic vessel of FIG. 1.

FIG. 3 is a rear view of the cosmetic vessel of FIG. 1.

FIG. 4 is a left side view of the cosmetic vessel of FIG. 1.

FIG. 5 is a right side view of the cosmetic vessel of FIG. 1; and,

FIG. 6 is a top view of the cosmetic vessel of FIG. 1.

A bottom view is omitted since it does not contain ornamental features.

**1 Claim, 6 Drawing Sheets**

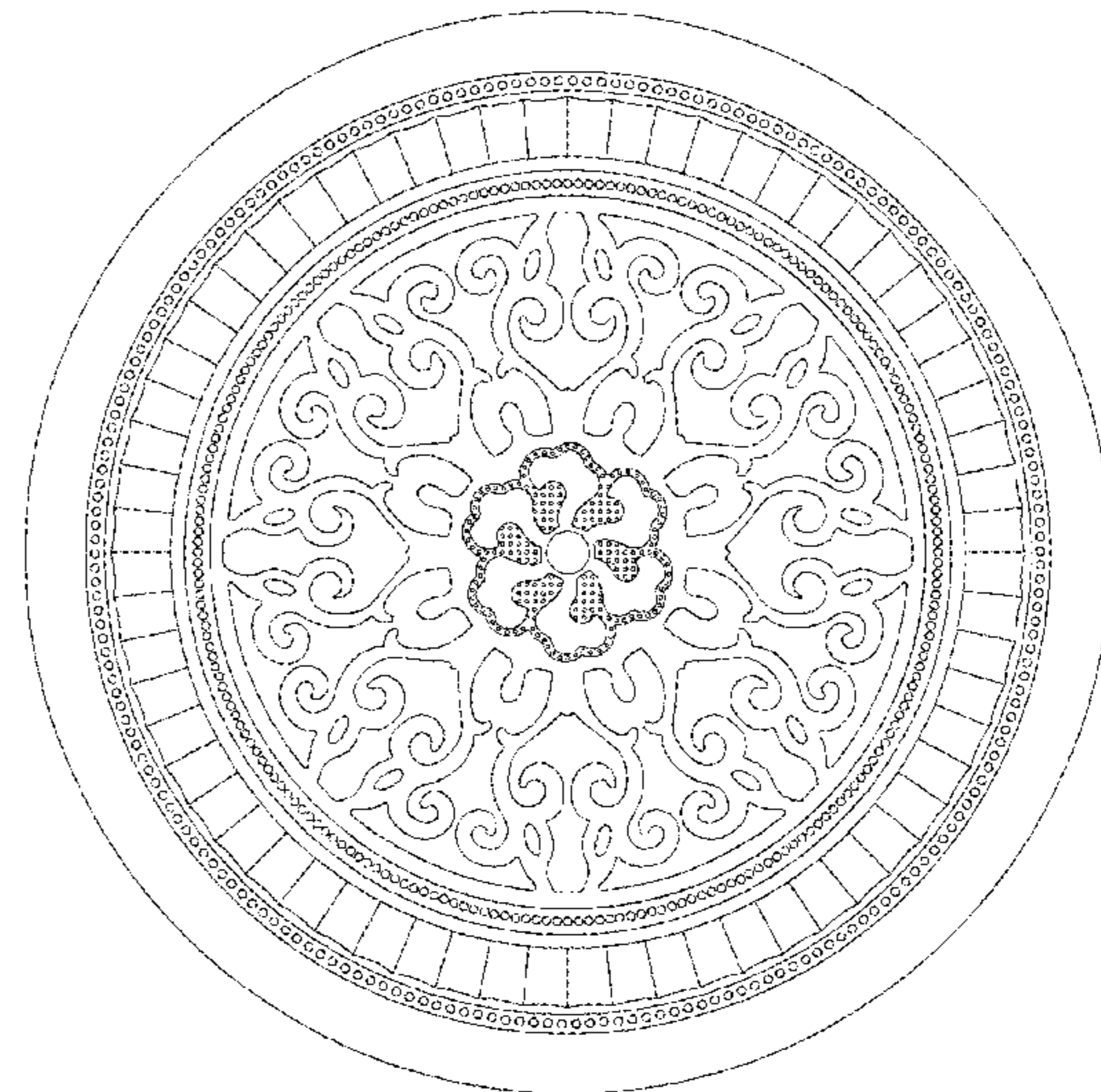
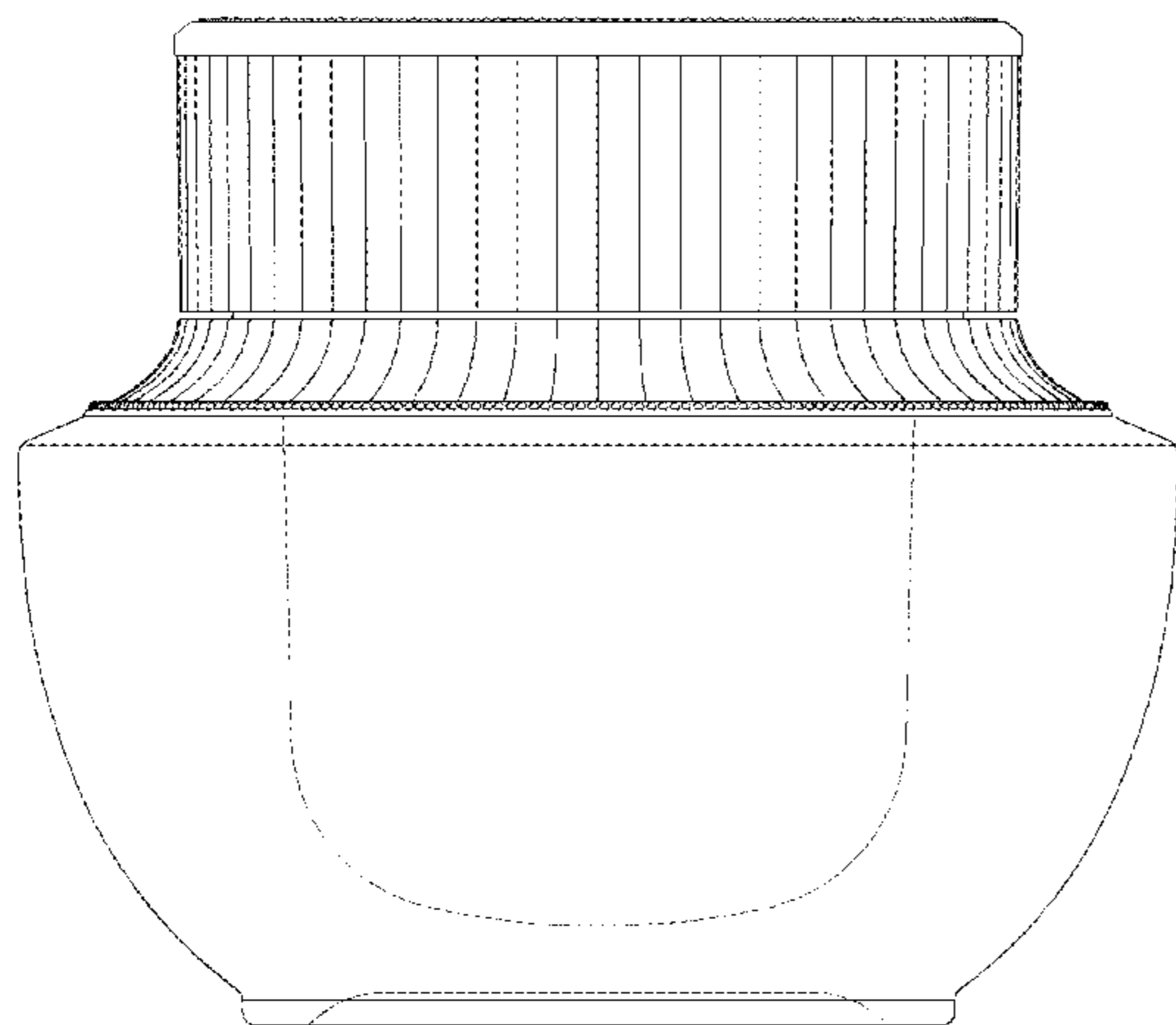

FIG. 1

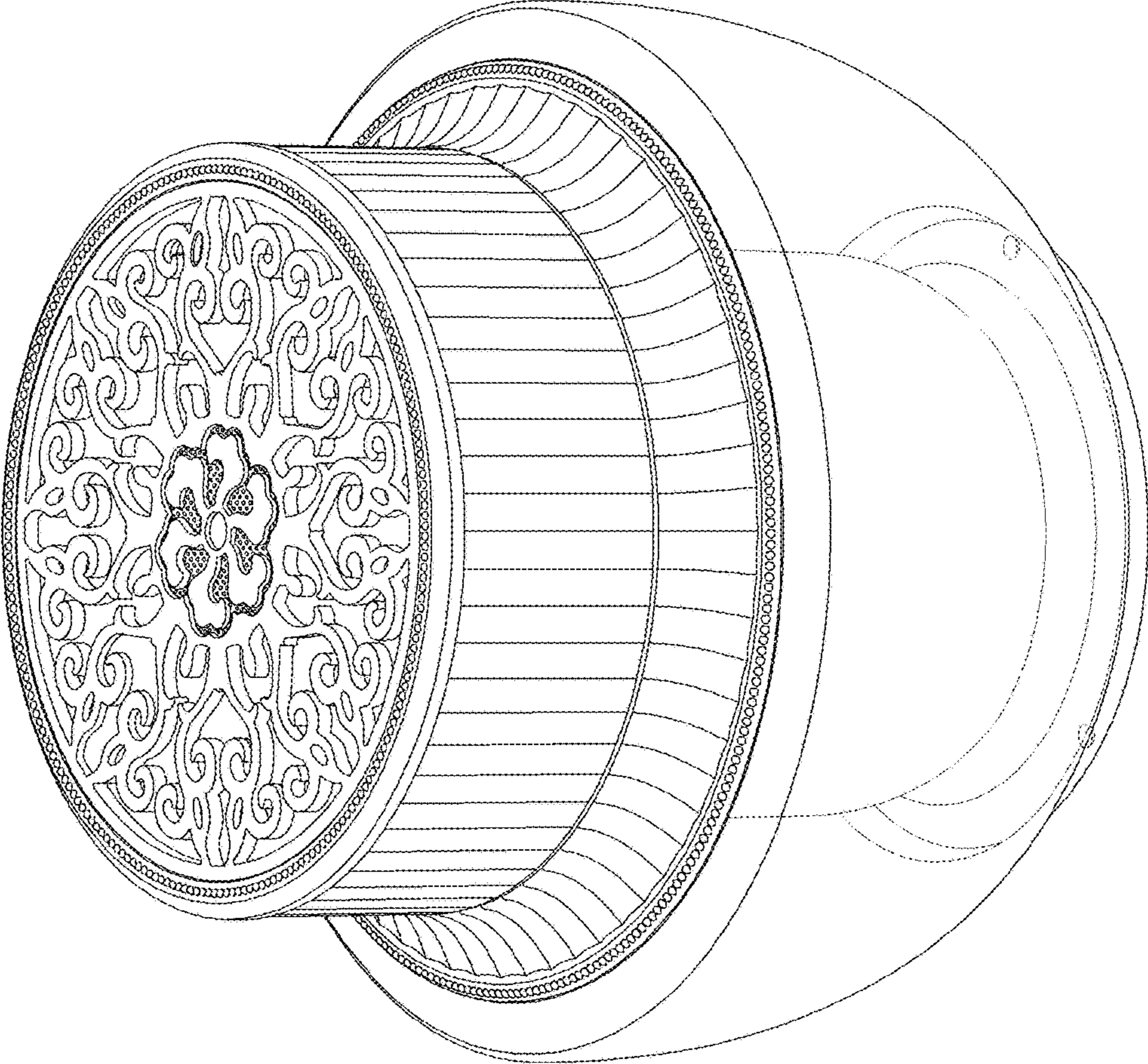

FIG. 2

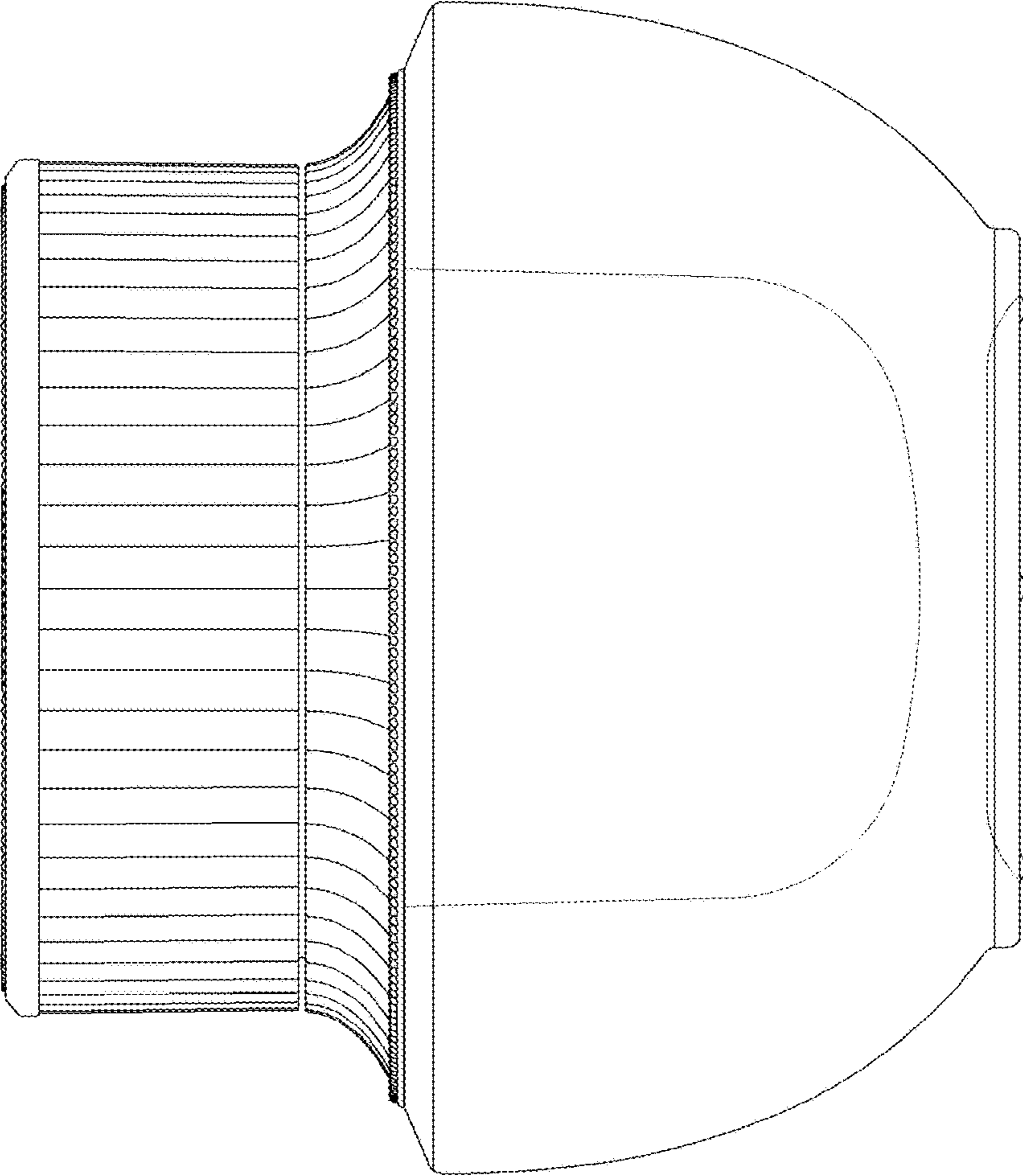

FIG. 3

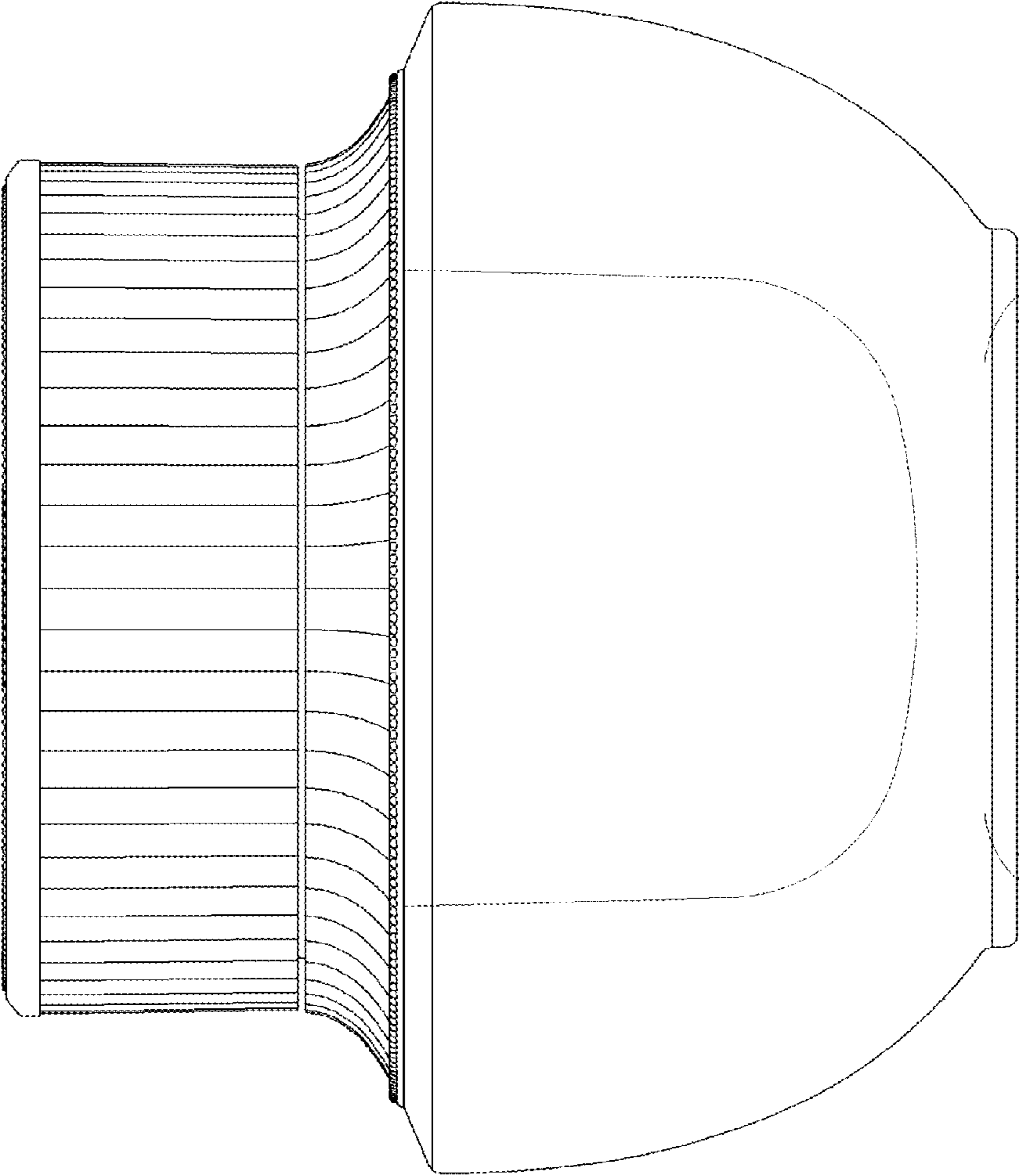

FIG. 4

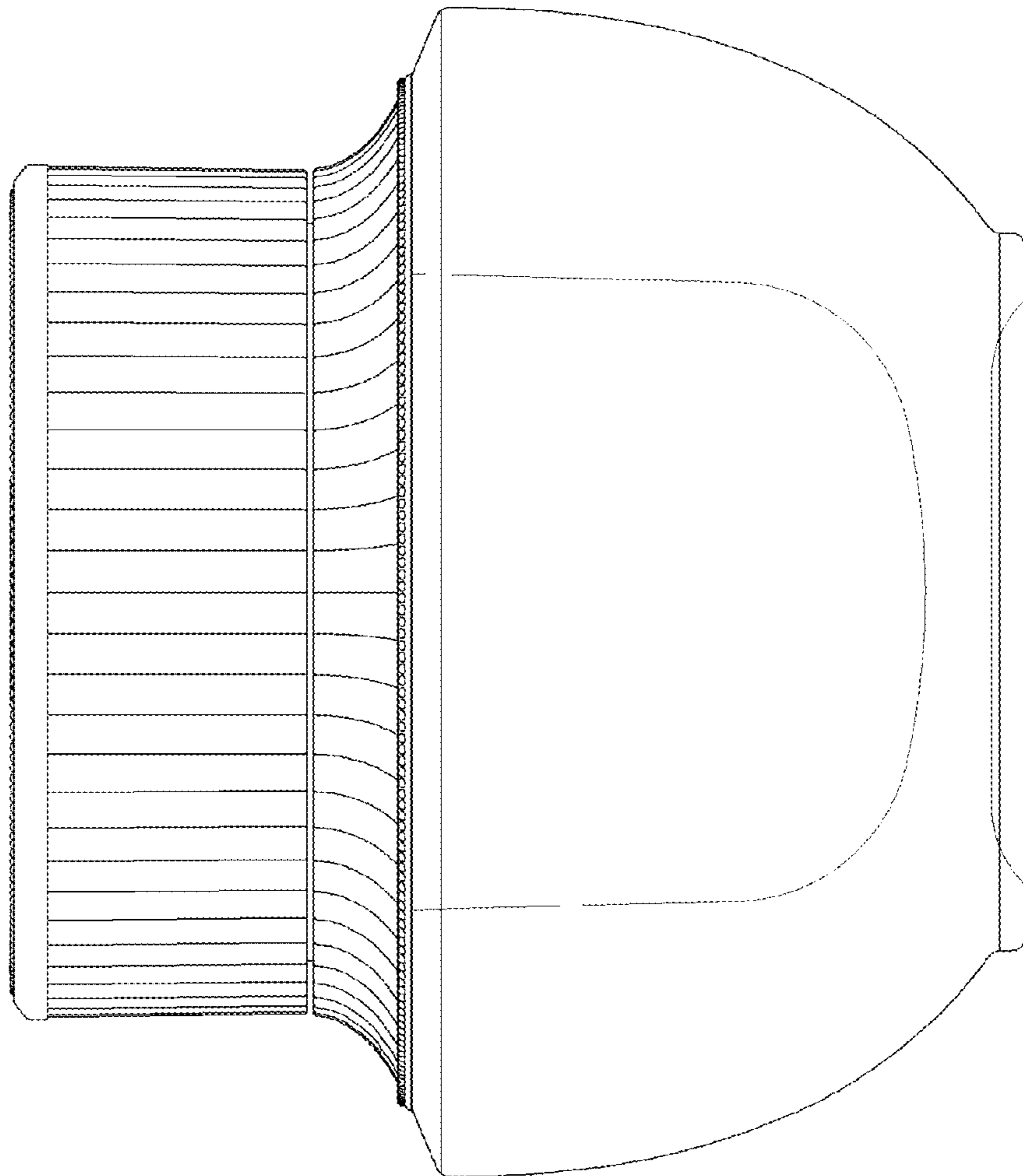

FIG. 5

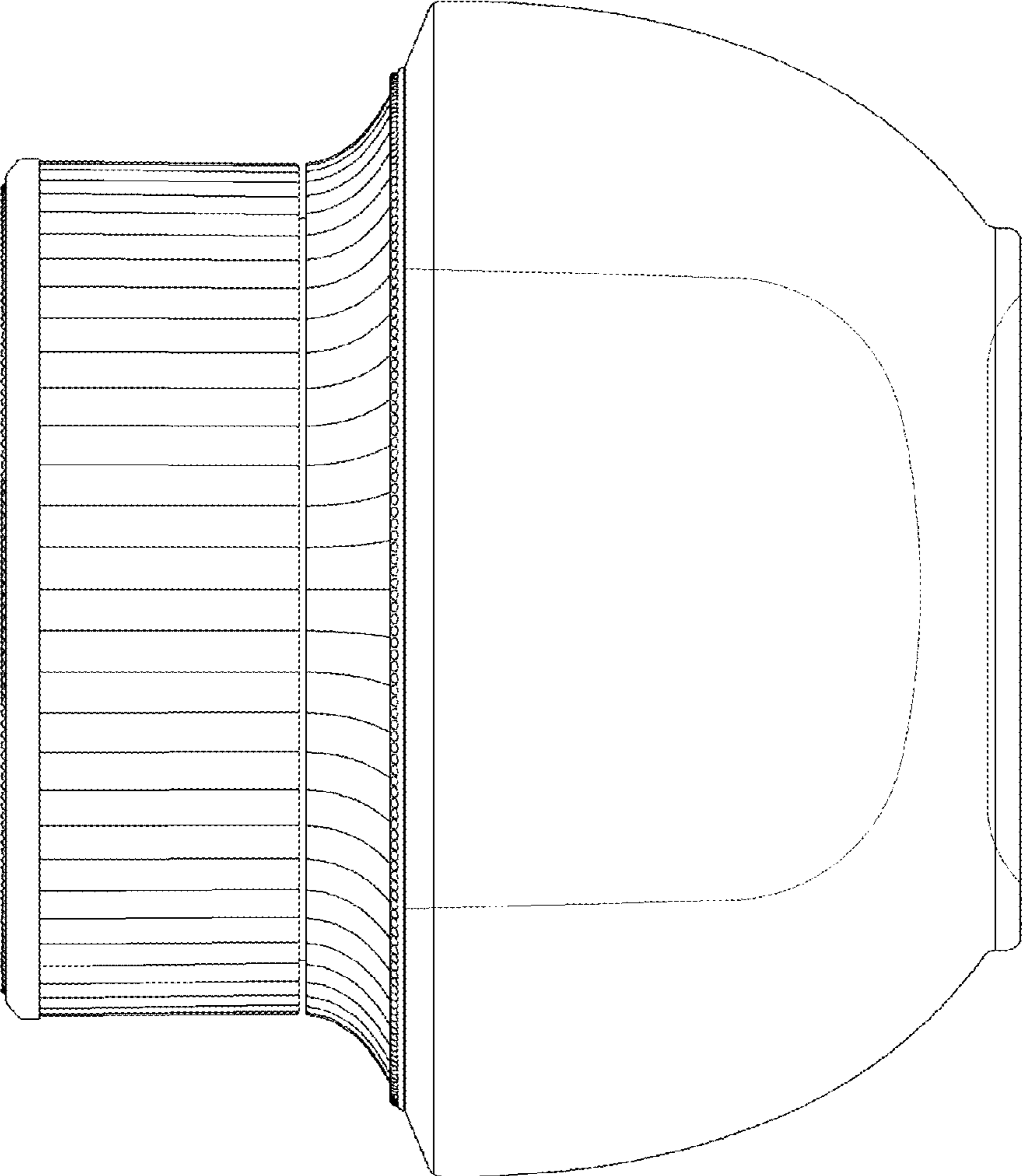

FIG. 6

