



US00D855470S

(12) **United States Design Patent**
Sterling

(10) **Patent No.:** **US D855,470 S**

(45) **Date of Patent:** **** Aug. 6, 2019**

(54) **CONTAINER**

(71) Applicant: **Henkel IP & Holding GmbH,**
Duesseldorf (DE)

(72) Inventor: **Daniel Peter Sterling,** Fairfield, CT
(US)

(73) Assignee: **Henkel IP & Holding GmbH** (DE)

(**) Term: **15 Years**

(21) Appl. No.: **29/635,972**

(22) Filed: **Feb. 5, 2018**

(51) **LOC (12) Cl.** **09-01**

(52) **U.S. Cl.**
USPC **D9/528; D9/531; D9/575**

(58) **Field of Classification Search**
USPC D9/516, 523, 527, 528, 530, 531-533,
D9/537, 538, 539, 560, 575, 715, 719
CPC B65D 23/10; B65D 1/0223; B65D 1/18;
B65D 15/22
See application file for complete search history.

(56) **References Cited**

U.S. PATENT DOCUMENTS

D321,624 S *	11/1991	Fiore	D7/317
D352,905 S *	11/1994	Beaver	D9/528
D385,795 S *	11/1997	Wysocki	D9/531
D392,188 S *	3/1998	Darr	D9/520
D401,154 S *	11/1998	Robinson	D9/528
D408,739 S *	4/1999	Satterfield	D9/520

D409,494 S *	5/1999	Frazer	D9/520
D469,019 S *	1/2003	Schlueter	D9/528
D511,462 S *	11/2005	Haley	D9/531
D512,320 S *	12/2005	Haley	D9/531
D544,359 S *	6/2007	Shehadey	D9/528
D580,768 S *	11/2008	Ferguson	D9/528
D589,351 S *	3/2009	Caldwell	D9/531
D629,694 S *	12/2010	Heisner	D9/528
D732,963 S *	6/2015	Hawry	D9/528
D799,325 S *	10/2017	Ozamiz	D9/523
D818,359 S *	5/2018	Sterling	D9/528
D821,881 S *	7/2018	Clemence	D9/528

* cited by examiner

Primary Examiner — Ian Simmons

Assistant Examiner — Keith Frank

(74) *Attorney, Agent, or Firm* — Bojuan Deng

(57) **CLAIM**

The ornamental design for container, as shown and described.

DESCRIPTION

FIG. 1 is a front perspective view of a container embodying the new design;

FIG. 2 is a front side elevation view thereof;

FIG. 3 is a rear side elevation view thereof;

FIG. 4 is a right side elevation view thereof;

FIG. 5 is a left side elevation view thereof;

FIG. 6 is a top plan view thereof; and,

FIG. 7 is a bottom plan view thereof.

The broken lines represent portions of the container which form no part of the claimed design.

1 Claim, 7 Drawing Sheets

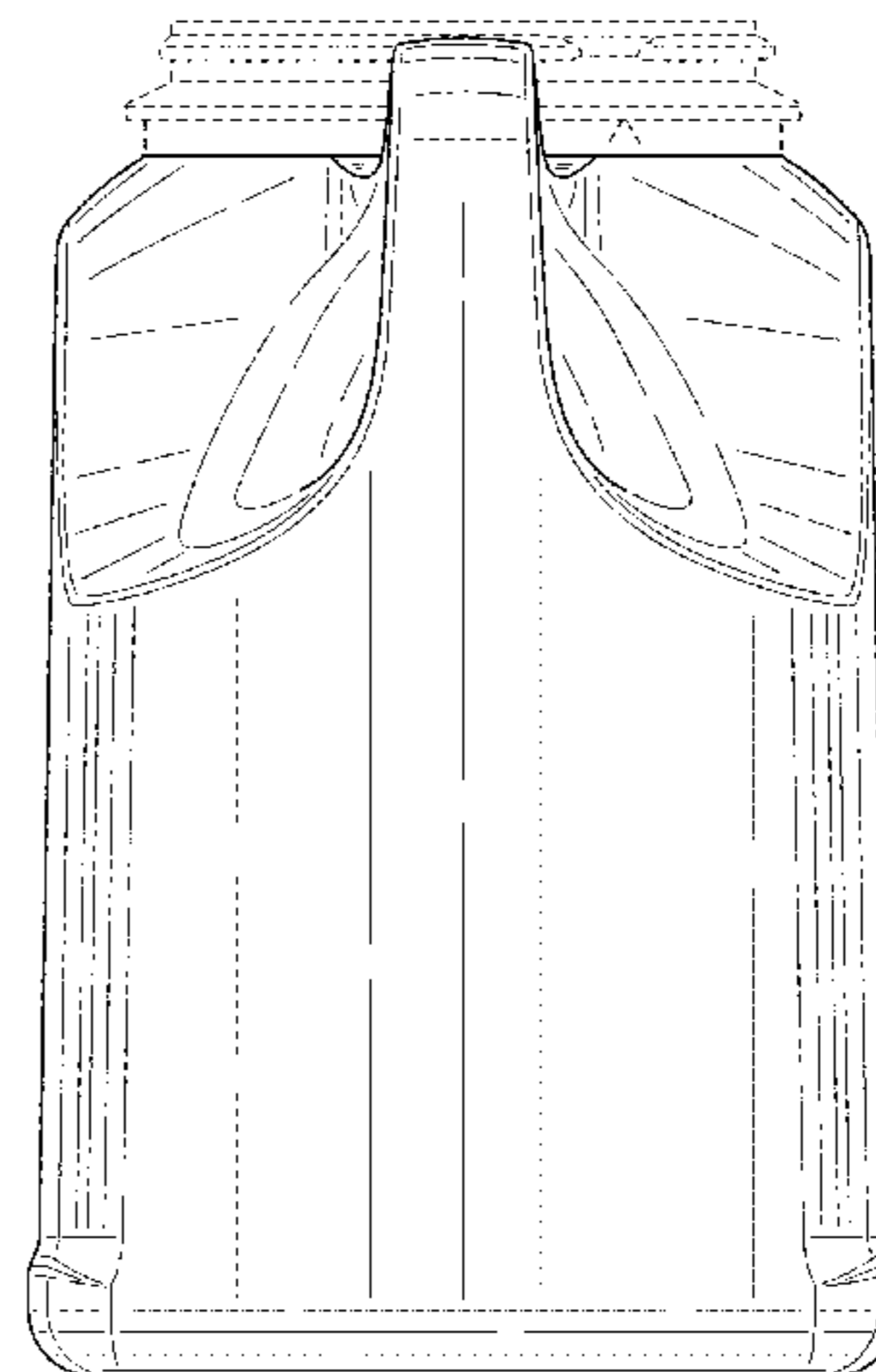
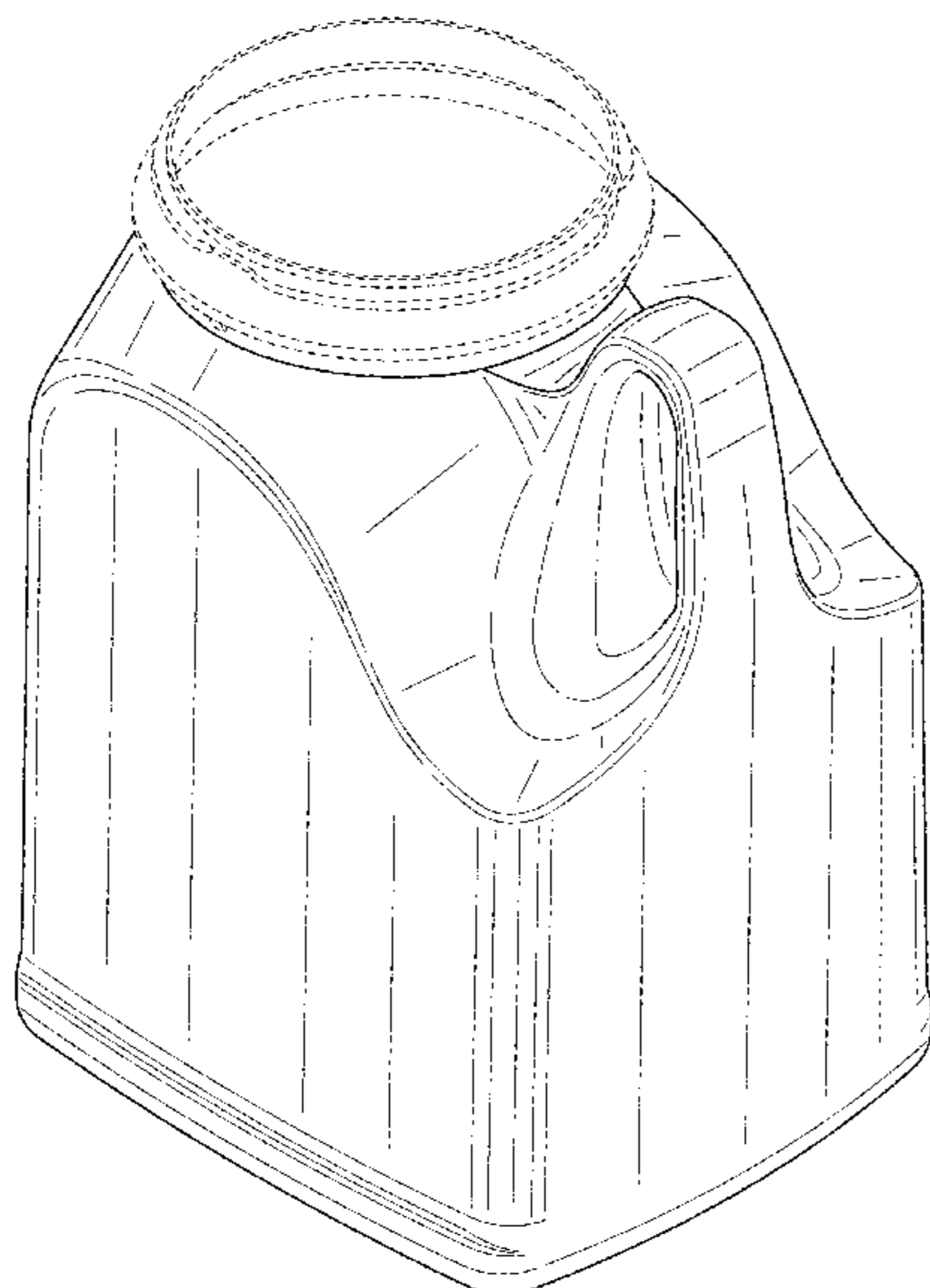

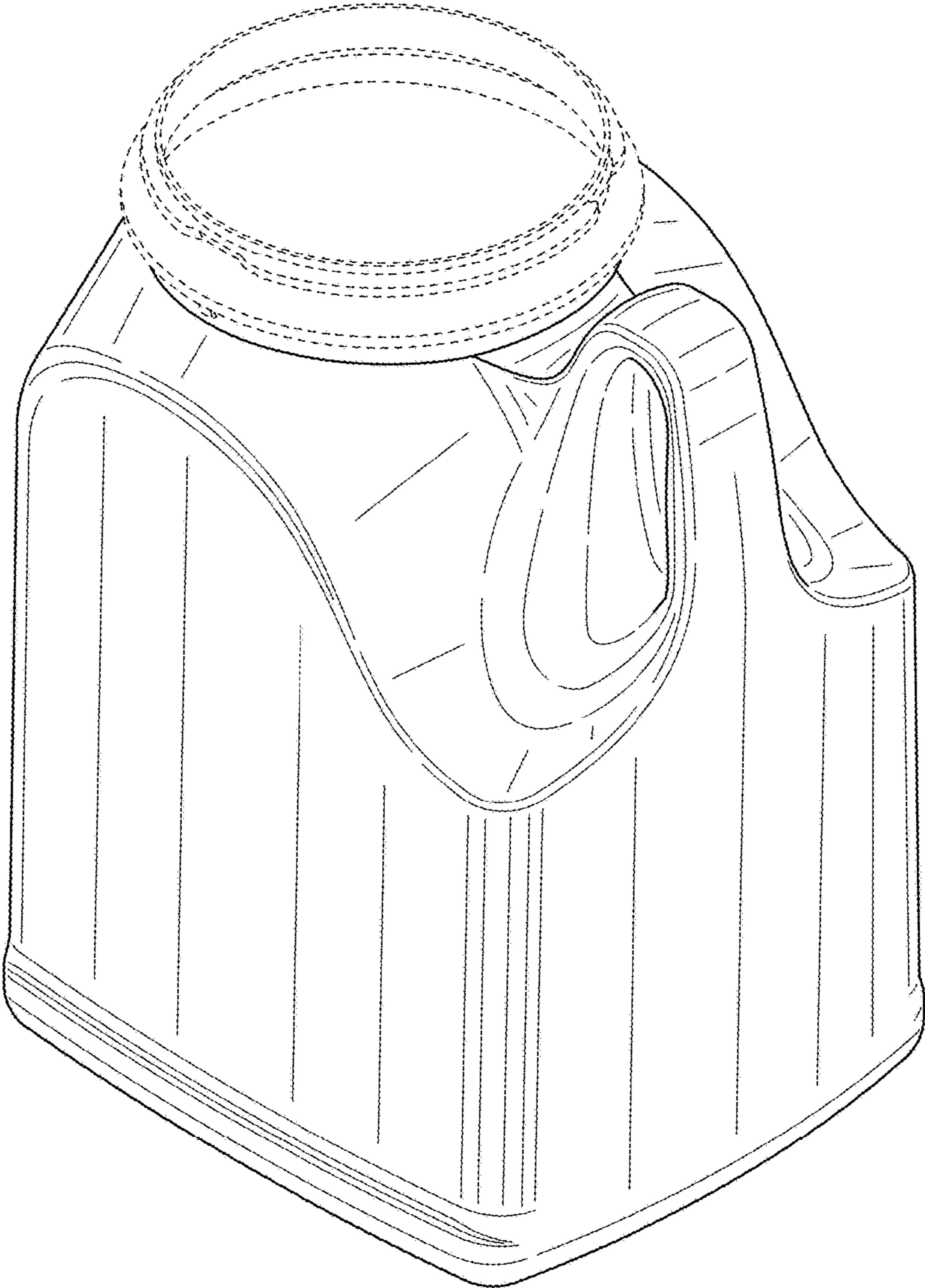

FIG. 1

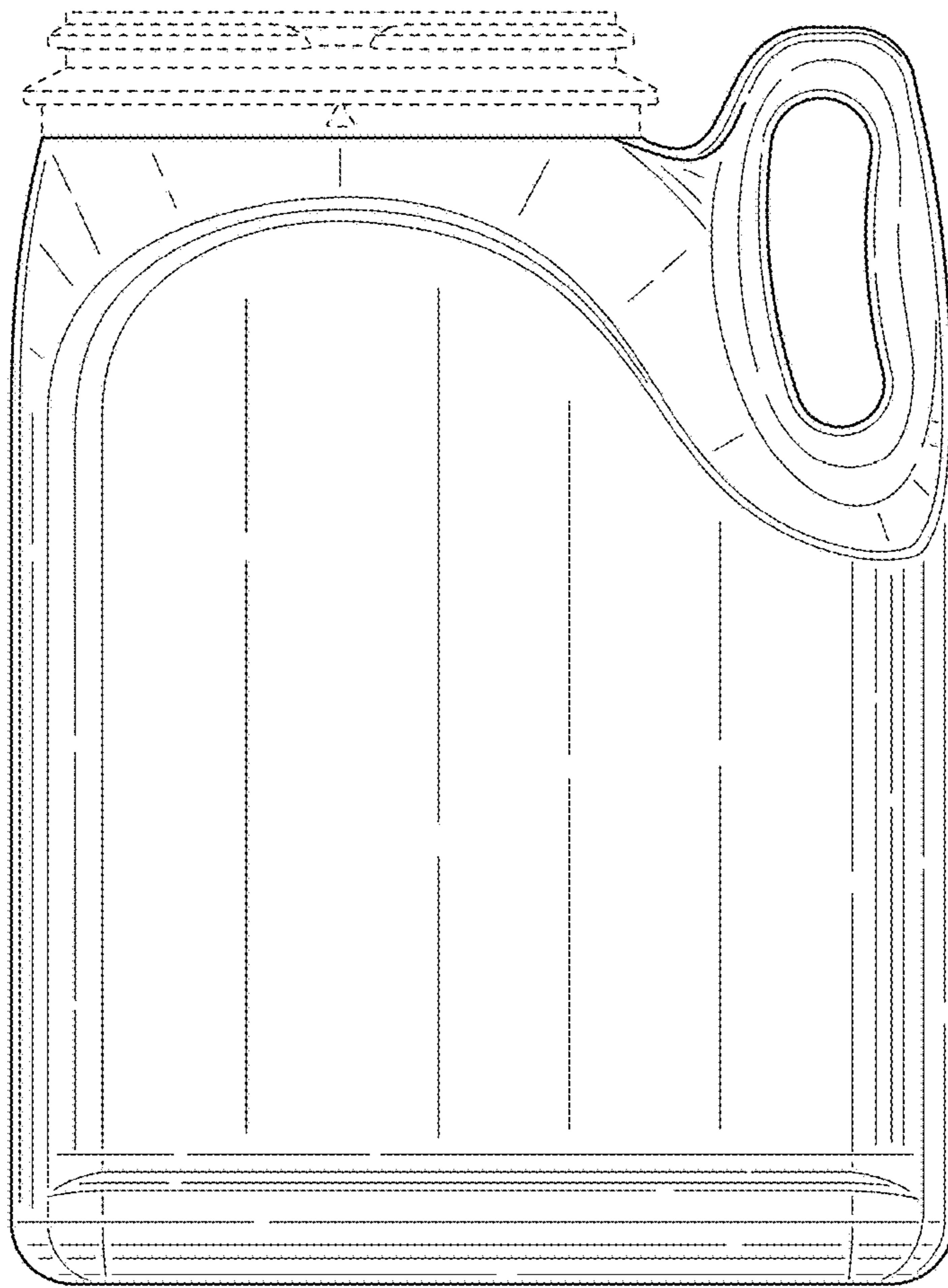

FIG.2

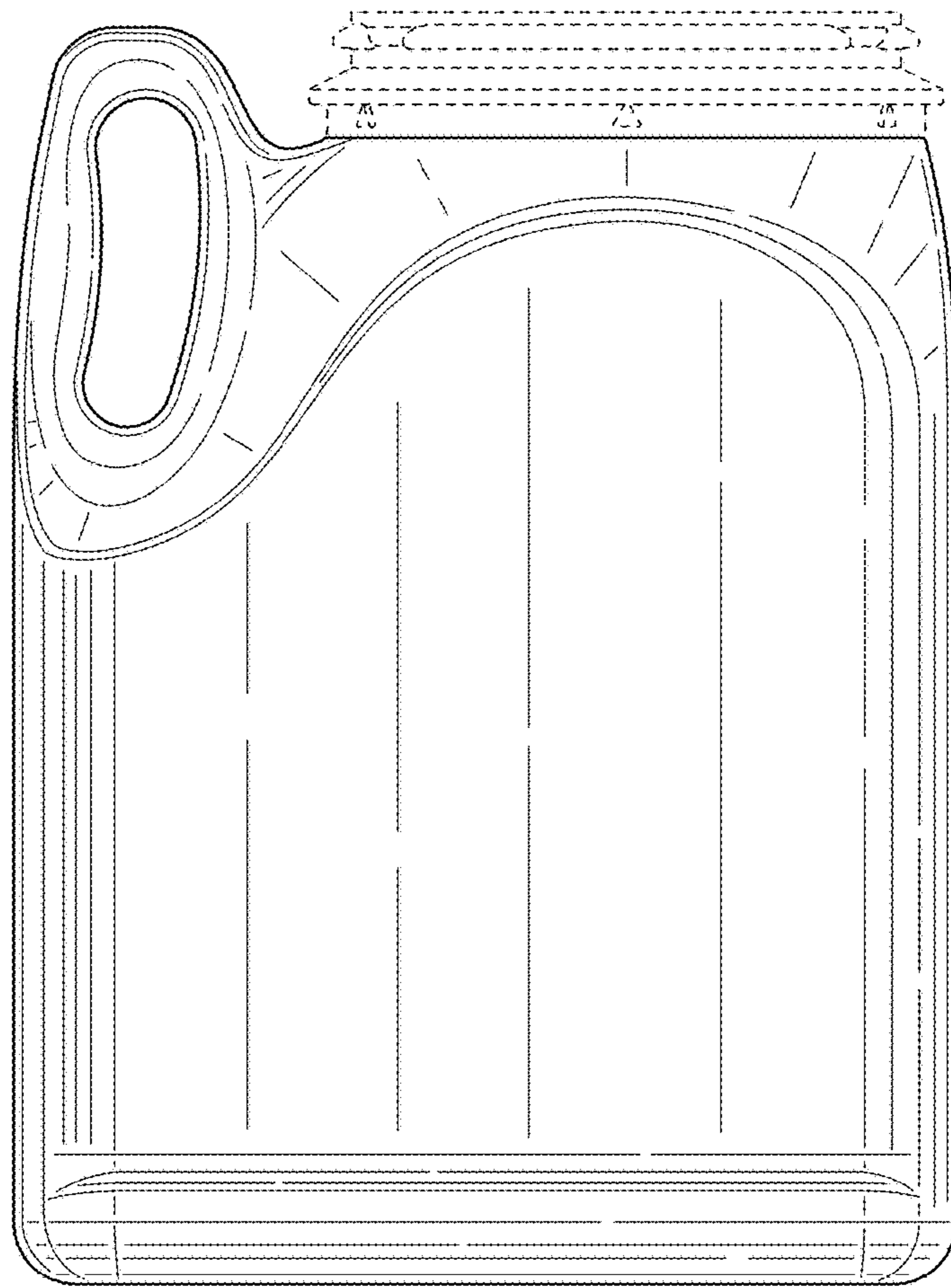

FIG. 3

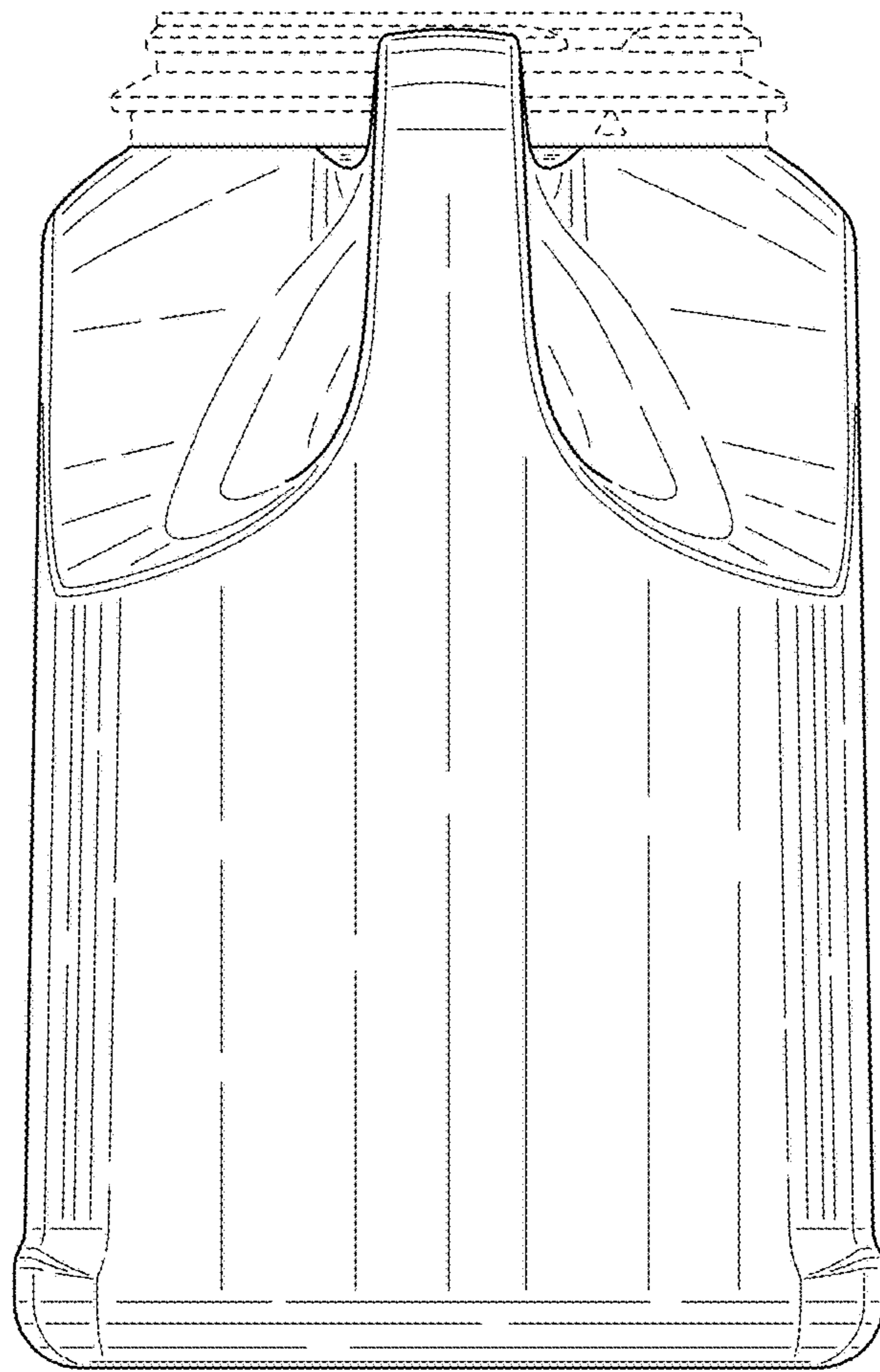

FIG. 4

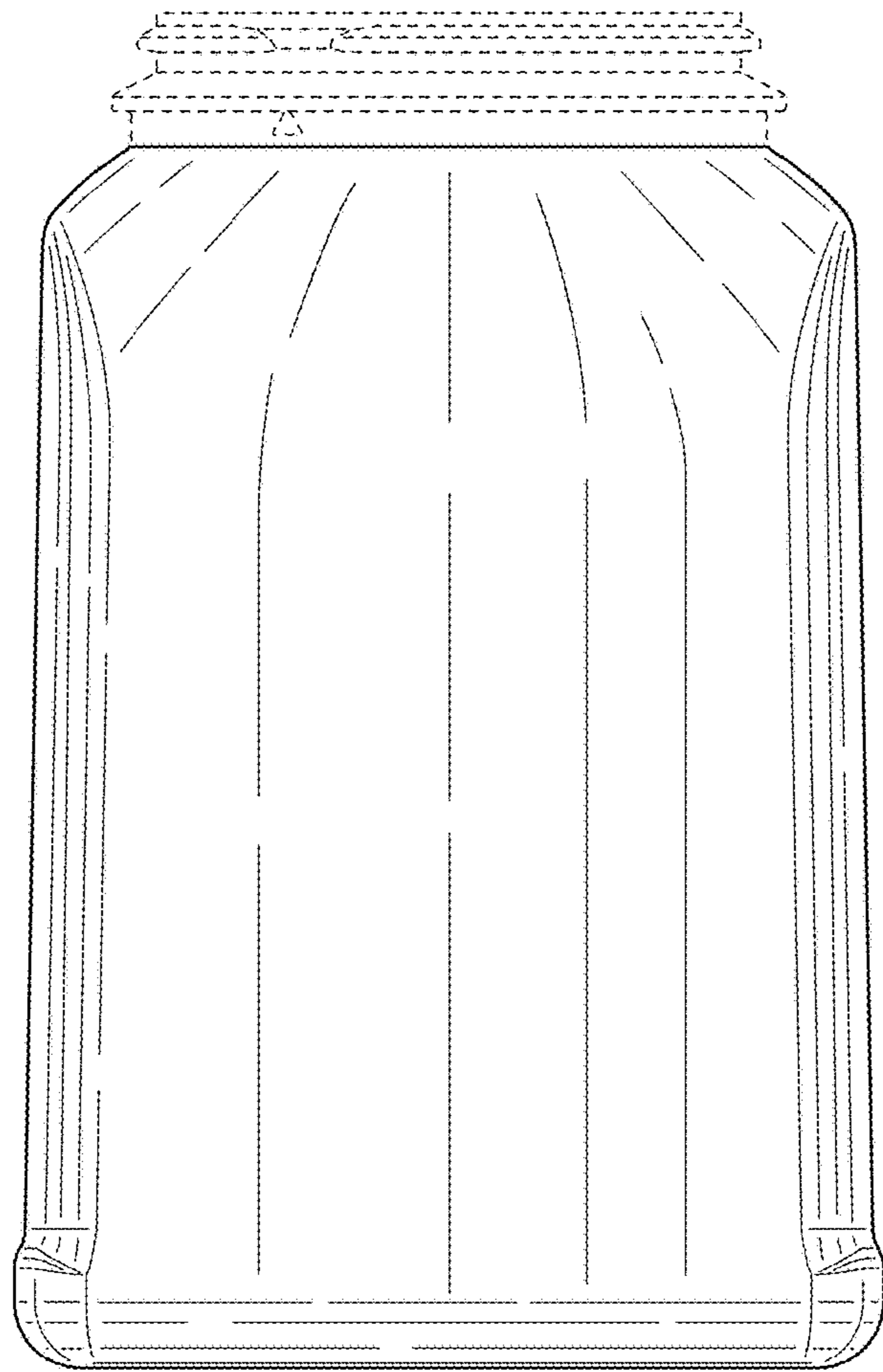

FIG.5

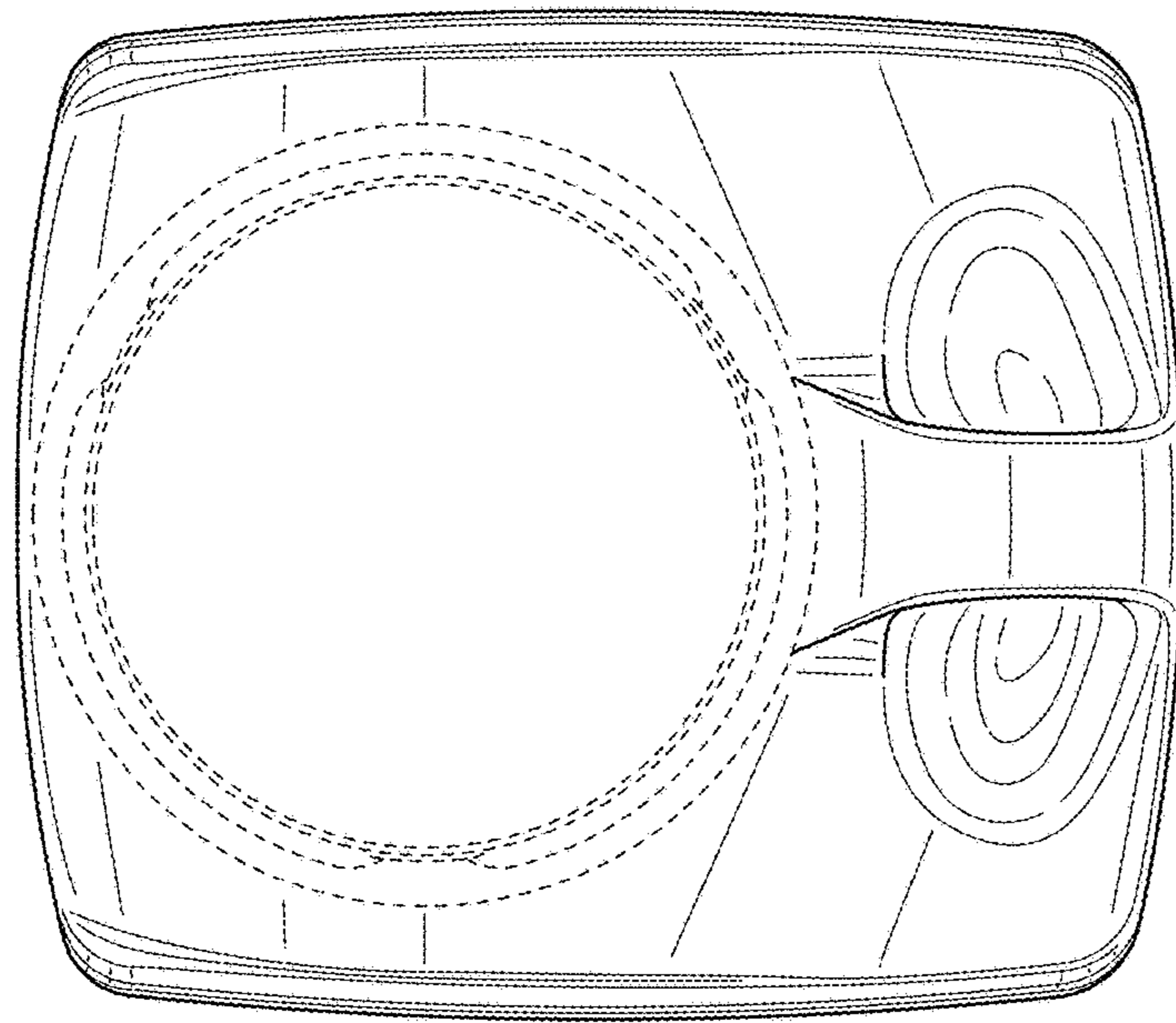

FIG.6

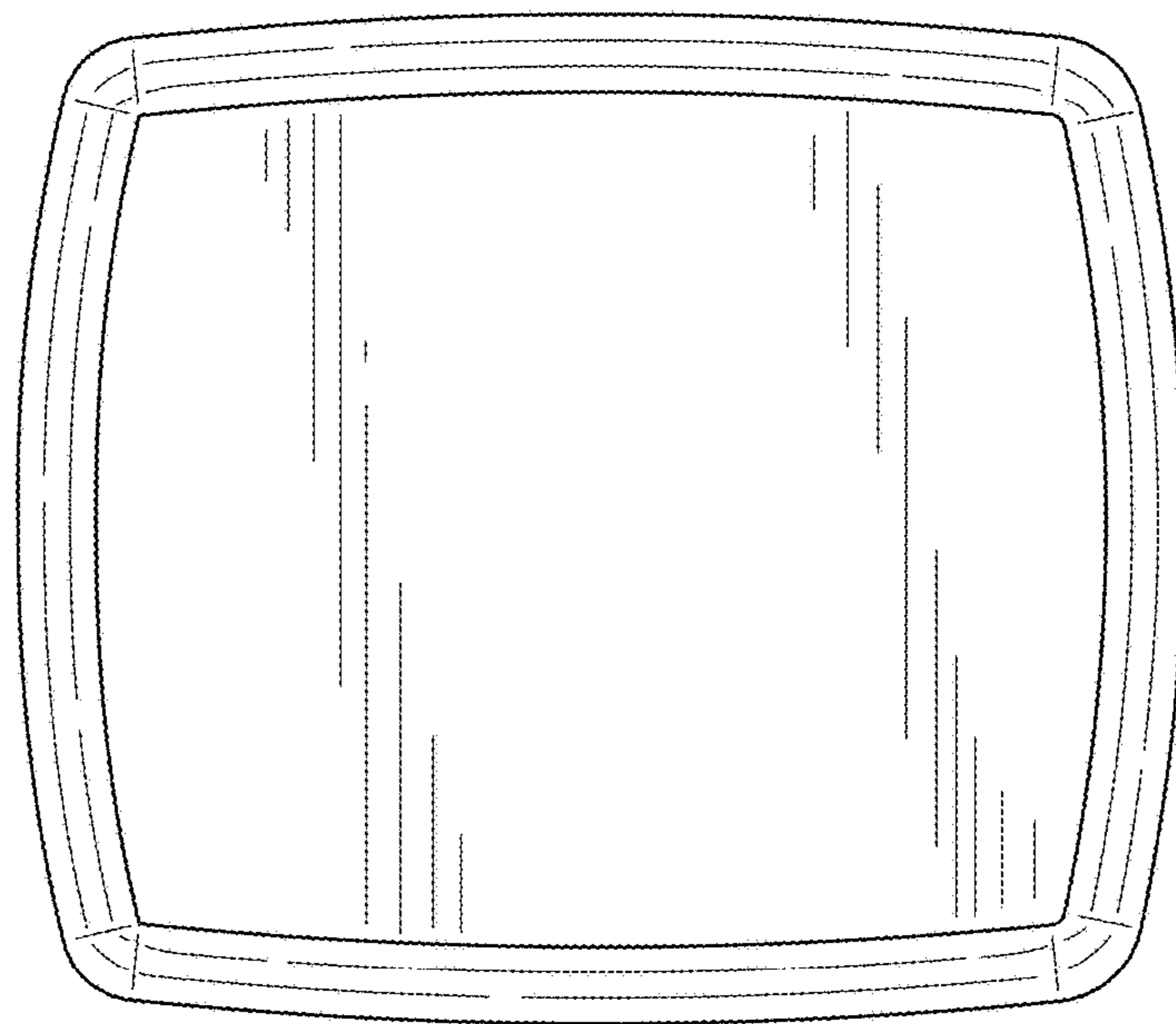

FIG.7