



US00D855466S

(12) **United States Design Patent**
Chen et al.

(10) **Patent No.:** **US D855,466 S**

(45) **Date of Patent:** **** Aug. 6, 2019**

(54) **CONTAINER**

(71) Applicant: **Conopco, Inc.**, Englewood Cliffs, NJ
(US)

(72) Inventors: **Weiqing Chen**, Shanghai (CN);
Thomas Peter Gilbert, Singapore (SG)

(73) Assignee: **Conopco, Inc.**, Englewood Cliffs, NJ
(US)

(**) Term: **15 Years**

(21) Appl. No.: **29/598,507**

(22) Filed: **Mar. 27, 2017**

(30) **Foreign Application Priority Data**

Sep. 30, 2016 (EM) 003400373-0001
Sep. 30, 2016 (EM) 003400373-0002
Sep. 30, 2016 (EM) 003400373-0003

(51) **LOC (12) Cl.** **09-01**

(52) **U.S. Cl.**
USPC **D9/504; D9/454**

(58) **Field of Classification Search**
USPC D9/434-435, 444-445, 449, 454, 500,
D9/503-504, 516, 520, 529, 549, 558,
D9/715; D3/202, 203.2, 302; D7/608,
D7/629-630; D28/4, 8, 76, 91
CPC B65D 1/00; B65D 1/02; B65D 1/0223;
B65D 23/00; B65D 81/00; B65D
2501/00; B65D 2501/0009
See application file for complete search history.

(56) **References Cited**

U.S. PATENT DOCUMENTS

D20,336 S 11/1890 Whilldin
D114,460 S 4/1939 Platt
D155,043 S * 8/1949 Serra D9/504

D223,691 S * 5/1972 Newman D28/76
D254,180 S 2/1980 Morin
4,440,181 A * 4/1984 Scherer A45D 29/007
132/73.5
4,703,863 A * 11/1987 Kohus A61J 9/00
215/11.1
D372,194 S 7/1996 Dallaire
D373,084 S * 8/1996 Choi D9/504
D405,699 S * 2/1999 Chae D9/558
D446,456 S * 8/2001 Adachi D9/504
D474,341 S * 5/2003 Cantone A45D 29/007
D4/116
D505,074 S * 5/2005 Bakic D9/504

(Continued)

OTHER PUBLICATIONS

Day Cream & Eye Cream Range, Herborist, PP1-1.

(Continued)

Primary Examiner — Dana Meyrow

(74) *Attorney, Agent, or Firm* — Gerard J. McGowan, Jr.

(57)

CLAIM

The ornamental design for a container, as shown and described.

DESCRIPTION

The file of this patent contains at least one drawing/photograph executed in color. Copies of this patent with color drawing(s)/photograph(s) will be provided by the Office upon request and payment of the necessary fee.

FIG. 1 is a perspective view of a container showing our new design;

FIG. 2 is a front elevational view thereof;

FIG. 3 is a rear elevational view thereof;

FIG. 4 is a side elevational view thereof;

FIG. 5 is an elevational view of the other side thereof; and,

FIG. 6 is a top plan view thereof.

1 Claim, 4 Drawing Sheets
(4 of 4 Drawing Sheet(s) Filed in Color)

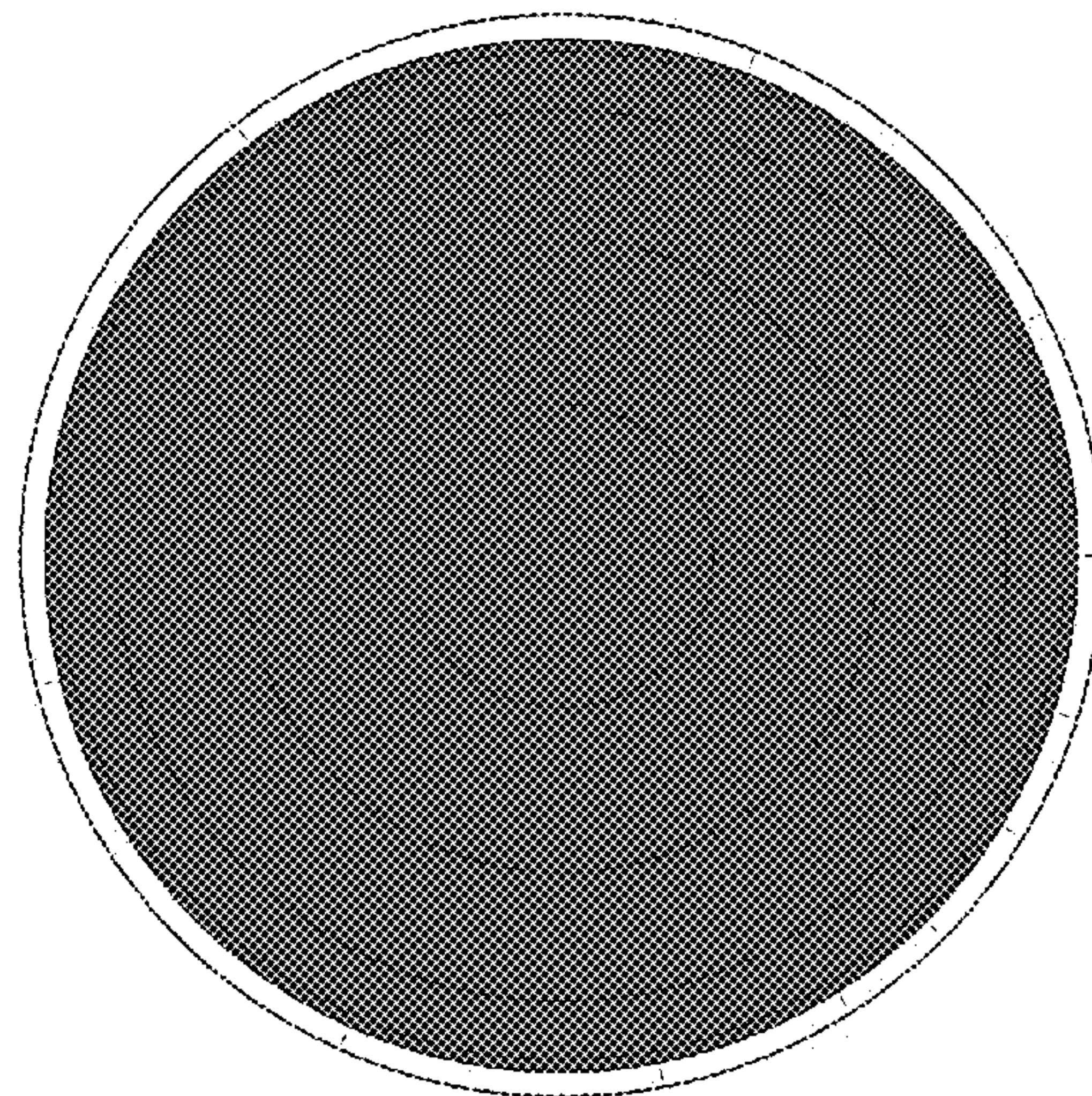
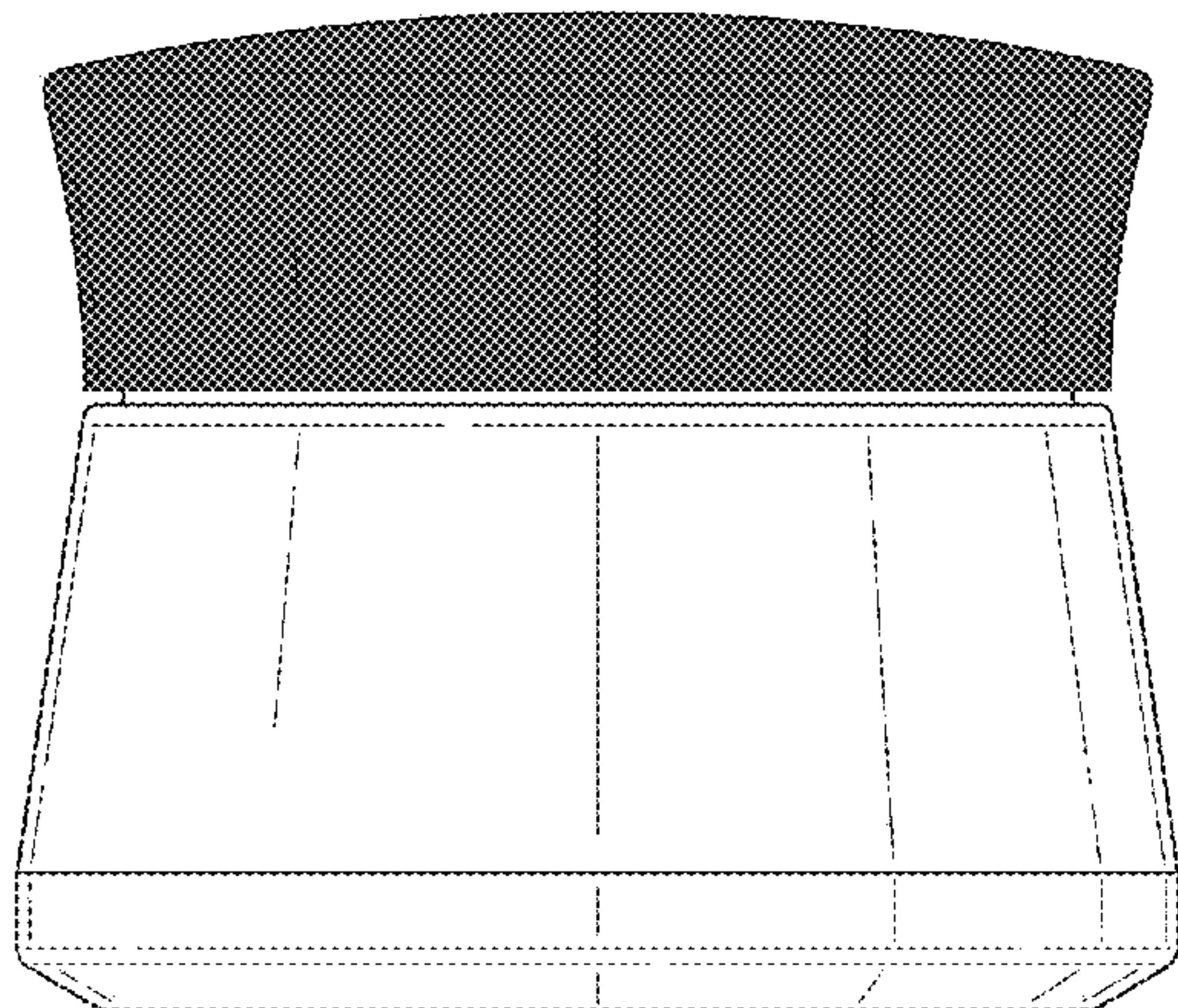

(56)

References Cited

U.S. PATENT DOCUMENTS

D509,434	S	*	9/2005	Haruta	D9/504
D512,914	S	*	12/2005	Moretti	D9/454
D530,572	S	*	10/2006	Daams	D7/615
D536,614	S	*	2/2007	Peterson	D9/454
D574,710	S	*	8/2008	Gangrade	D9/504
D619,456	S	*	7/2010	Walters	D9/444
D699,593	S		2/2014	Boon et al.		
D716,427	S		10/2014	Lim et al.		
D739,738	S	*	9/2015	Kawai	D9/435
D816,505	S	*	5/2018	Percassi	D9/529
2011/0297704	A1	*	12/2011	Esteve	A45D 34/00 222/390

OTHER PUBLICATIONS

Regener-activ Contorno de Ojos, Ponds, PP1-1Eye cream pack from Spain.

Co-pending Application: Applicant: Chen et al., U.S. Appl. No. 29/598,538, filed Mar. 27, 2017.

Eye Cream; Herborist eye cream; 1.

Day Cream; Herborist day cream; ; 1.

Silky All Day Moisturizing Eye Gel; Heborist; 1.

Silky All-Day Moisturizing Facial Cream; Herborist Silky All-Day Moisturizing Facial Cream; 1.

* cited by examiner

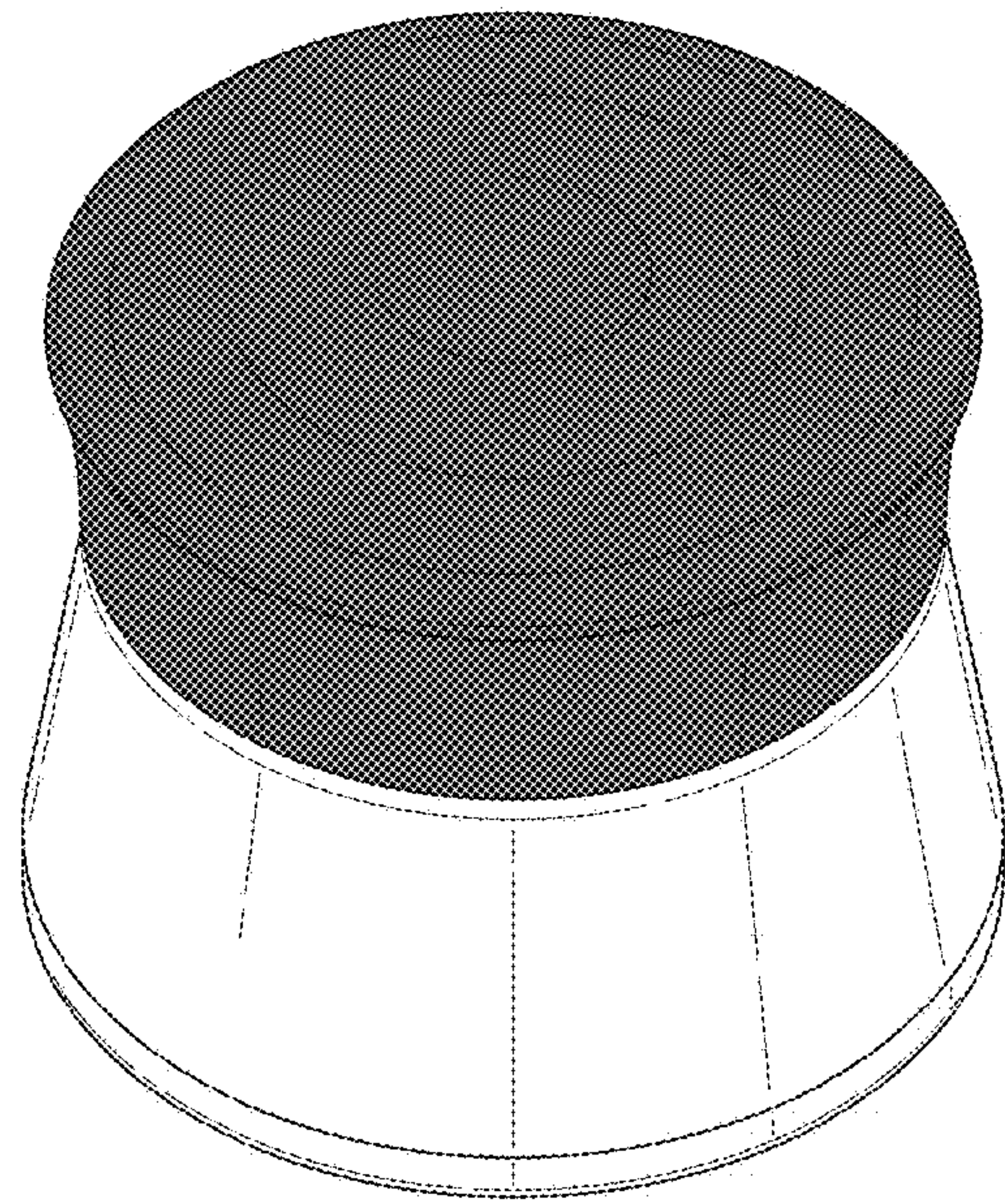

Fig. 1

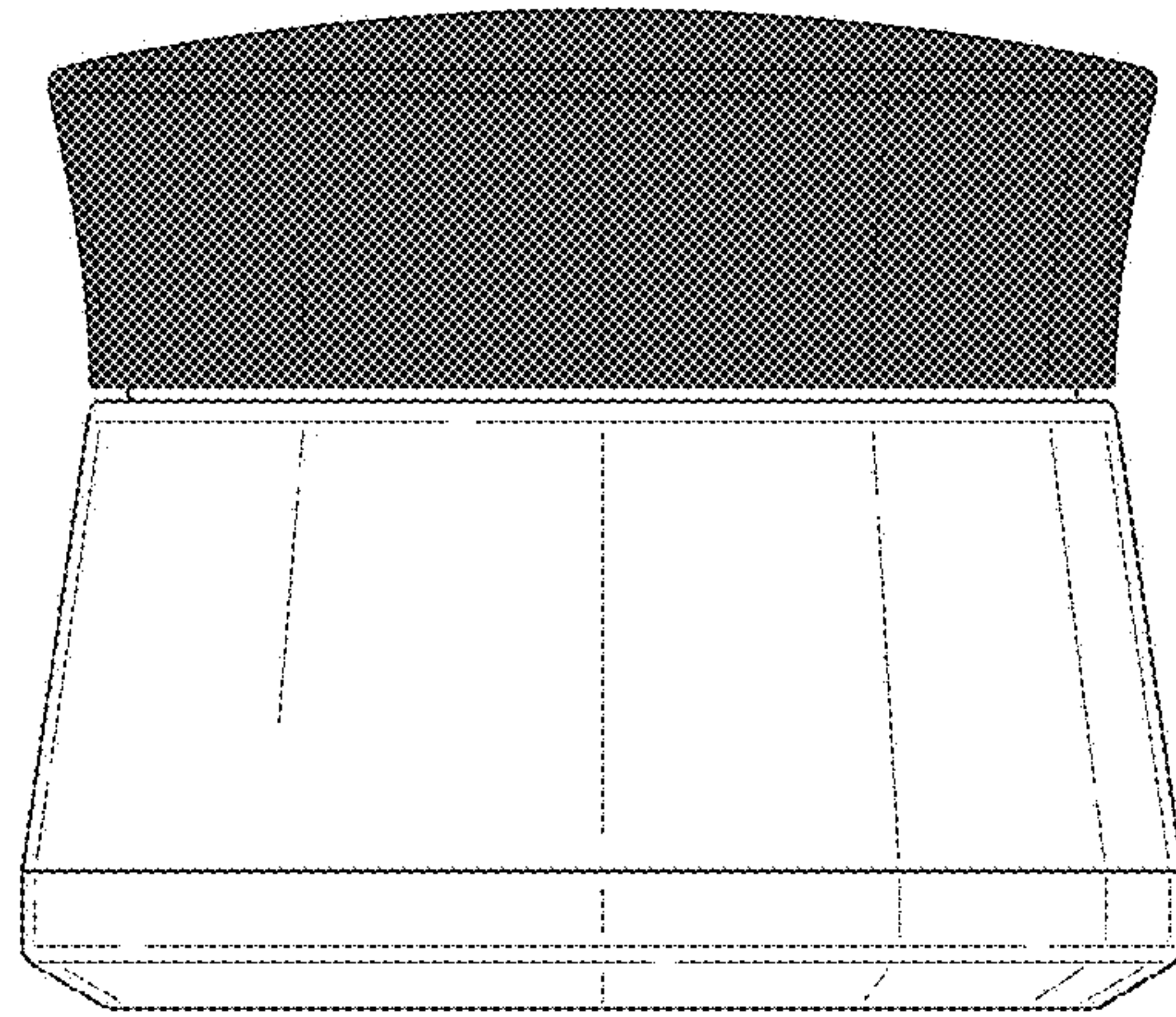

Fig. 2

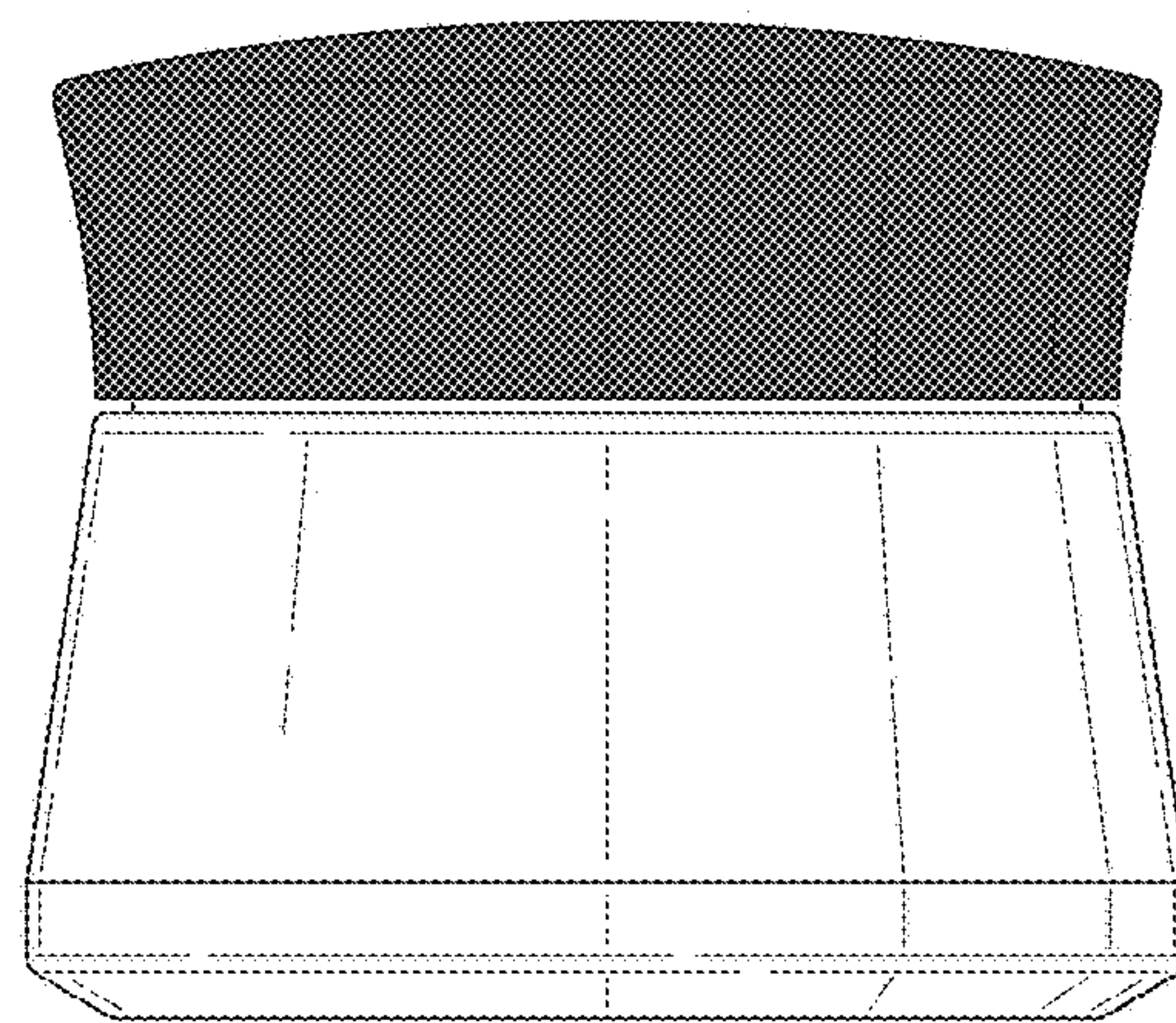

Fig. 3

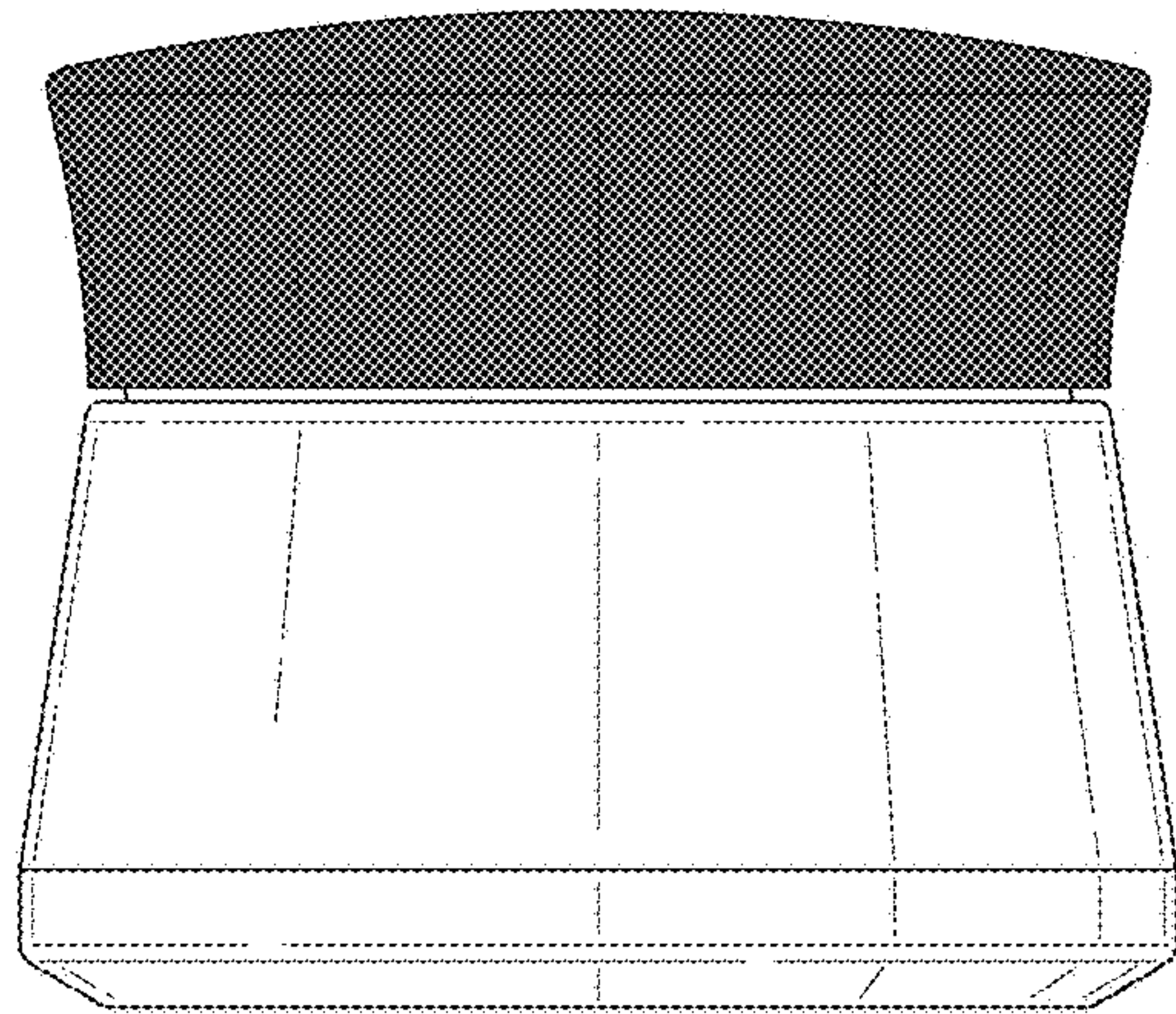

Fig. 4

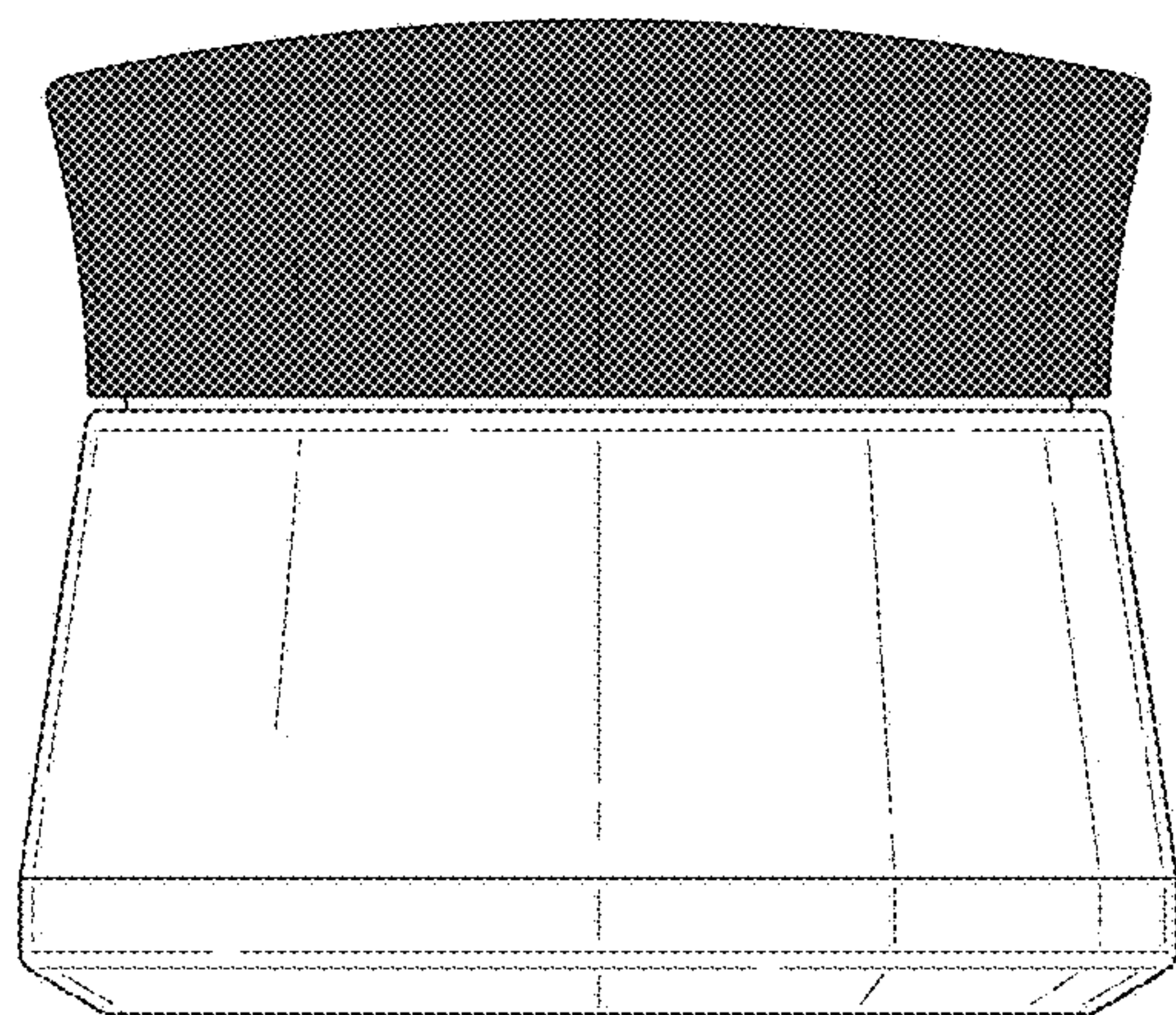

Fig. 5

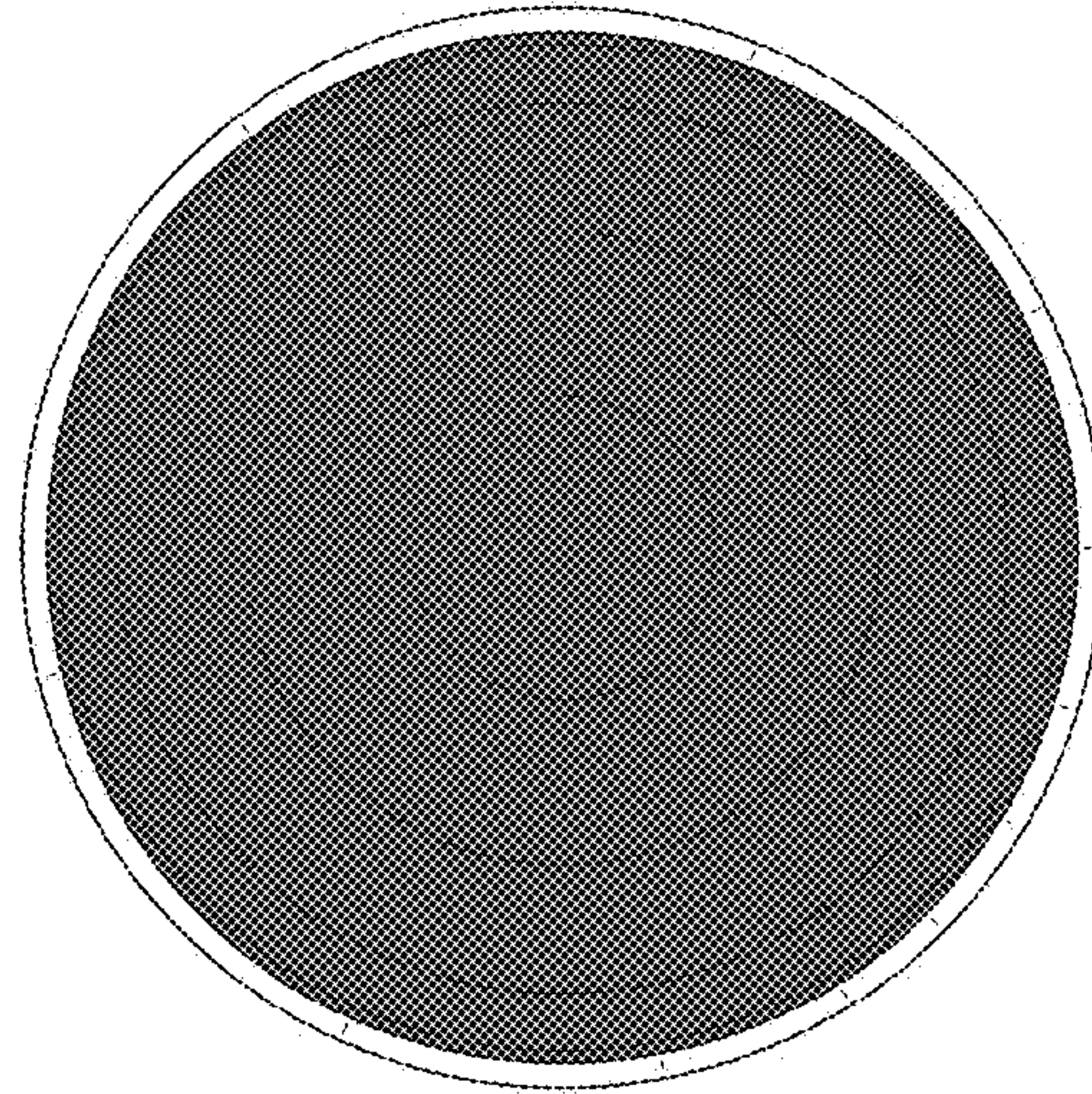

Fig. 6