



US00D855345S

(12) **United States Design Patent** (10) **Patent No.:** **US D855,345 S**
Segers et al. (45) **Date of Patent:** **** Aug. 6, 2019**

(54) **LOUNGE BED** D829,016 S * 9/2018 Segers D6/370
D829,017 S * 9/2018 Cazzaniga D6/377
(71) Applicant: **TRIBU N.V.**, Bilzen (BE) D831,370 S * 10/2018 Massaud D6/381

(72) Inventors: **Wim Segers**, Maaseik (BE); **Bob Segers**, Maaseik (BE)

(73) Assignee: **TRIBU N.V.**, Bilzen (BE)

(**) Term: **15 Years**

(21) Appl. No.: **29/619,175**

(22) Filed: **Sep. 27, 2017**

(30) **Foreign Application Priority Data**

Apr. 3, 2017 (EM) 003837772-0004

(51) **LOC (12) Cl.** **06-01**

(52) **U.S. Cl.**
USPC **D6/370**

(58) **Field of Classification Search**
USPC D6/334-336, 361, 368, 382, 370,
D6/374-381, 716, 716.1-716.8, 717.2
CPC A47C 4/00; A47C 4/02; A47C 4/03; A47C
4/04; A47C 4/08; A47C 4/10; A47C 4/14;
A47C 5/10; A47C 17/00; A47C 17/64;
A47C 17/70

See application file for complete search history.

(56) **References Cited**

U.S. PATENT DOCUMENTS

D274,870 S * 7/1984 Claman D6/369
D275,343 S * 9/1984 Claman D6/369
D525,040 S * 7/2006 Muller D6/370
D525,796 S * 8/2006 Thomkins D6/369
D526,797 S * 8/2006 Thomkins D6/369
D552,369 S * 10/2007 Graham D6/381
D675,842 S * 2/2013 Li D6/369
D774,793 S * 12/2016 Cazzaniga D6/369
D829,015 S * 9/2018 Cazzaniga D6/369

OTHER PUBLICATIONS

Daybed, posted at Tribu.com:80, posted on Sep. 8, 2015. site visited Nov. 4, 2018. online, available from internet: https://web.archive.org/web/20150908223855/http://www.tribu.com:80/sites/default/files/collections/downloads/mood-mood_1.pdf (Year: 2015).*

Bedding, posted at Tribu.com, posted on Dec. 9, 2017, site visited Nov. 4, 2018. online, available from internet: https://www.tribu.com/sites/default/files/styles/colors_1/public/products/colors/details/moodloungebedearthbrownstudiozonder-kussens760x500.jpg?itok=XqJS2y7p (Year: 2017).*

* cited by examiner

Primary Examiner — Mary Ann Calabrese

Assistant Examiner — Catherine Ho

(74) *Attorney, Agent, or Firm* — Ladas & Parry LLP

(57) **CLAIM**

We claim the ornamental design for a lounge bed, as shown and described.

DESCRIPTION

FIG. 1 is a perspective view from the top, and left side of the lounge bed embodying our new design; FIG. 2 is a front elevational view thereof; FIG. 3 is a rear elevational view thereof; FIG. 4 is a left side elevational view thereof; FIG. 5 is a right side elevational view thereof; FIG. 6 is a top plan view thereof; and, FIG. 7 is a bottom plan view thereof.

The broken line portion of the figure drawings is included to show portions of the article that forms no part of the claimed design.

1 Claim, 7 Drawing Sheets

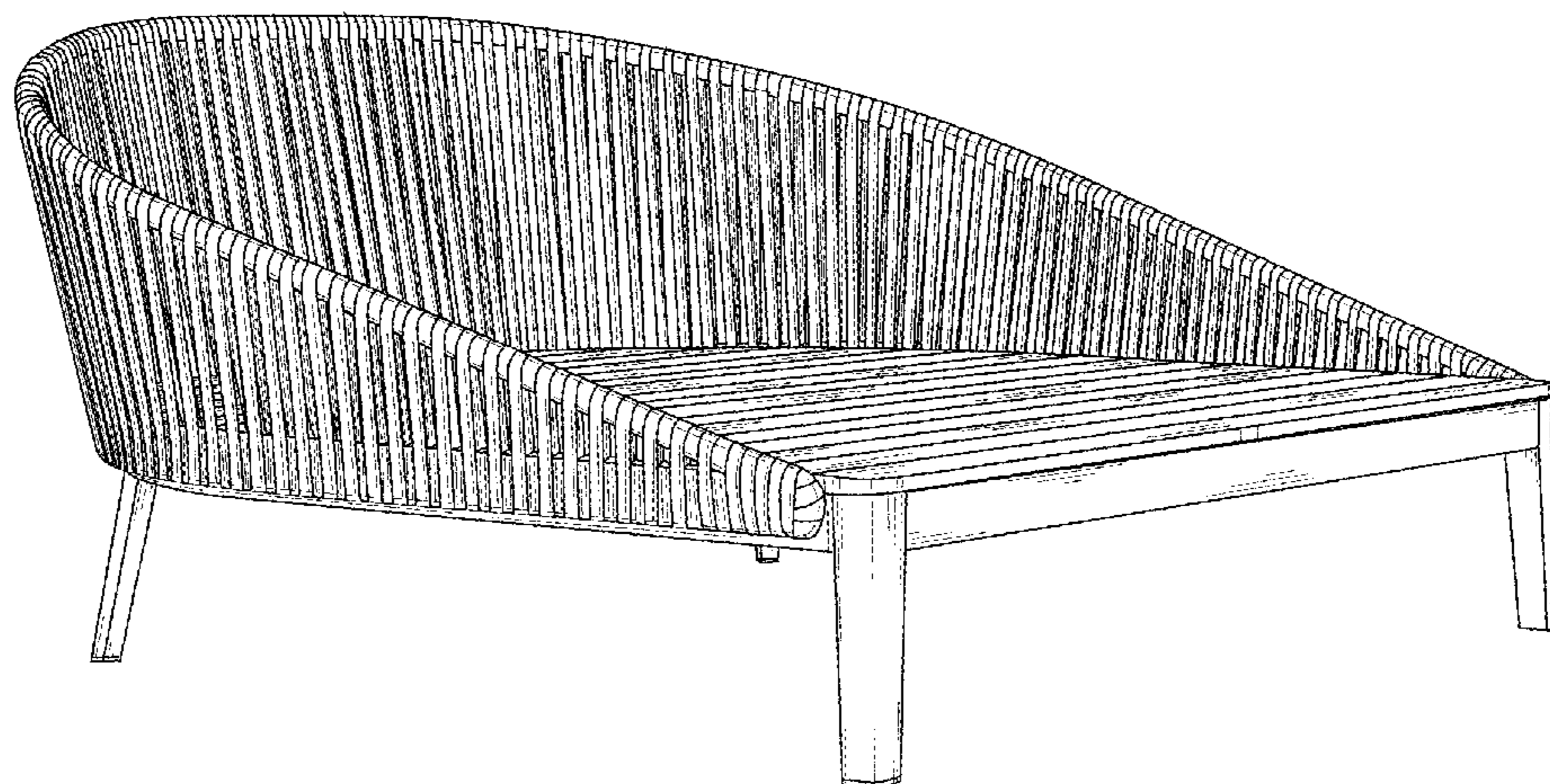

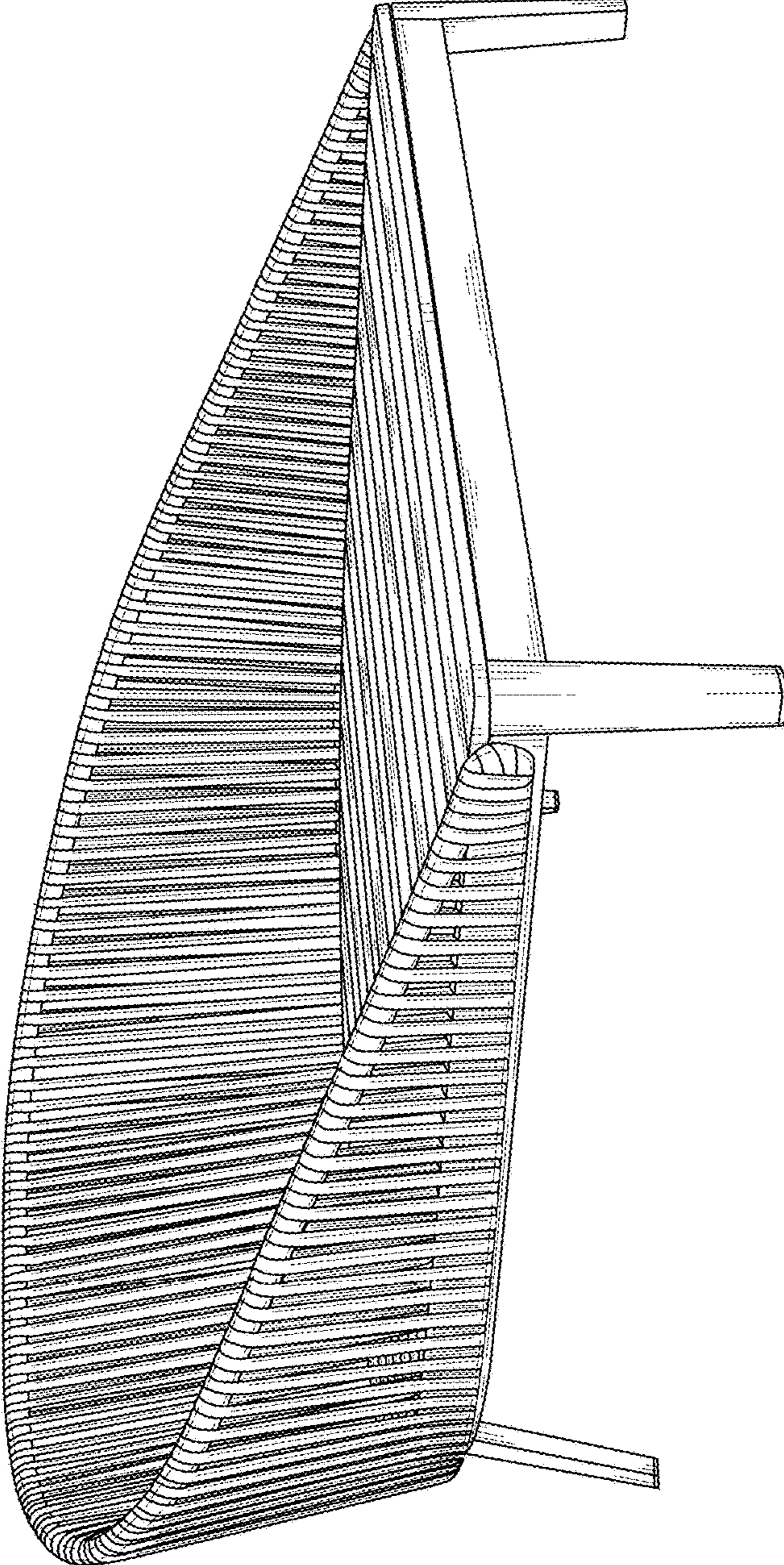

FIG. 1

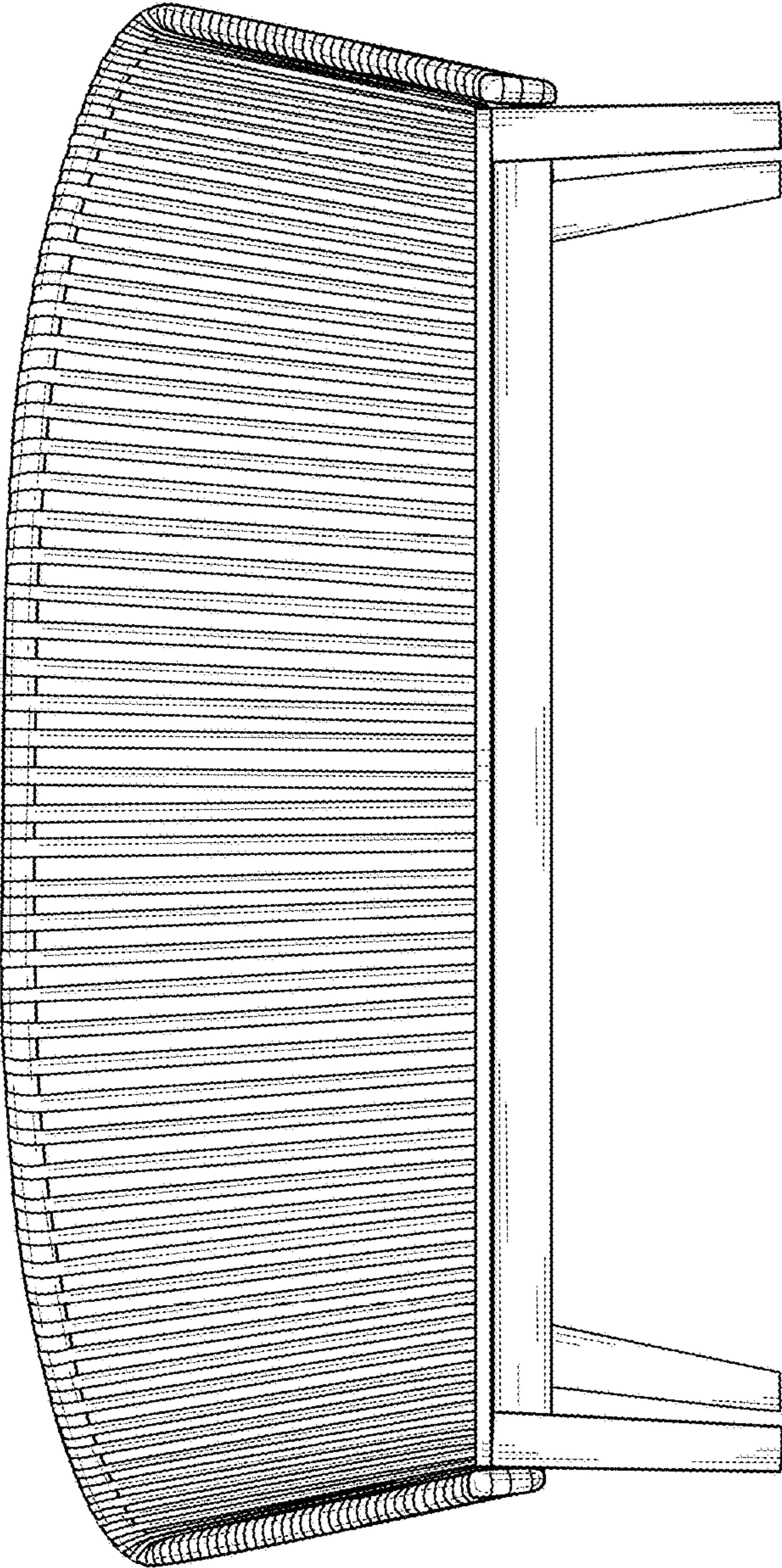

FIG. 2

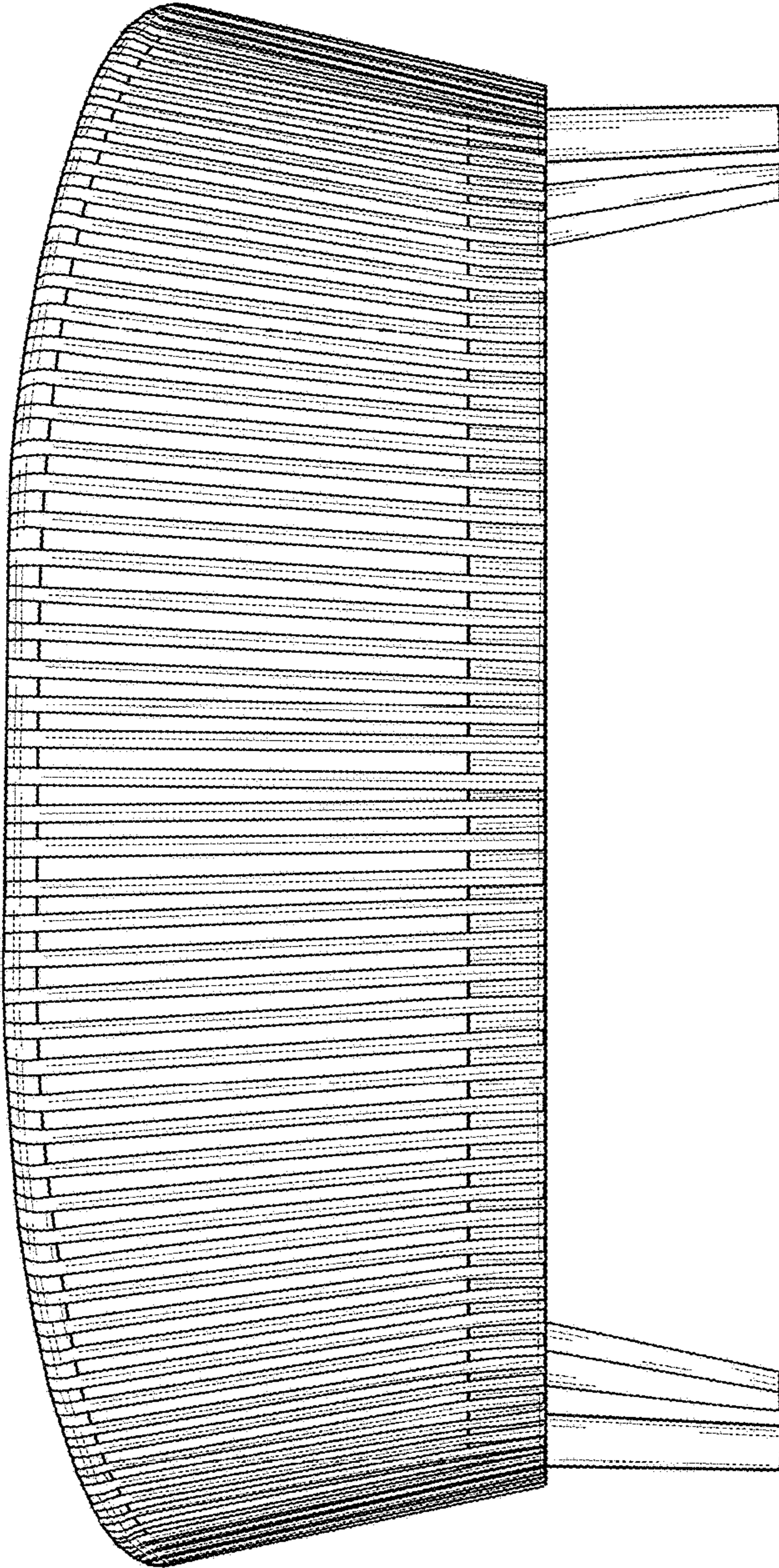

FIG. 3

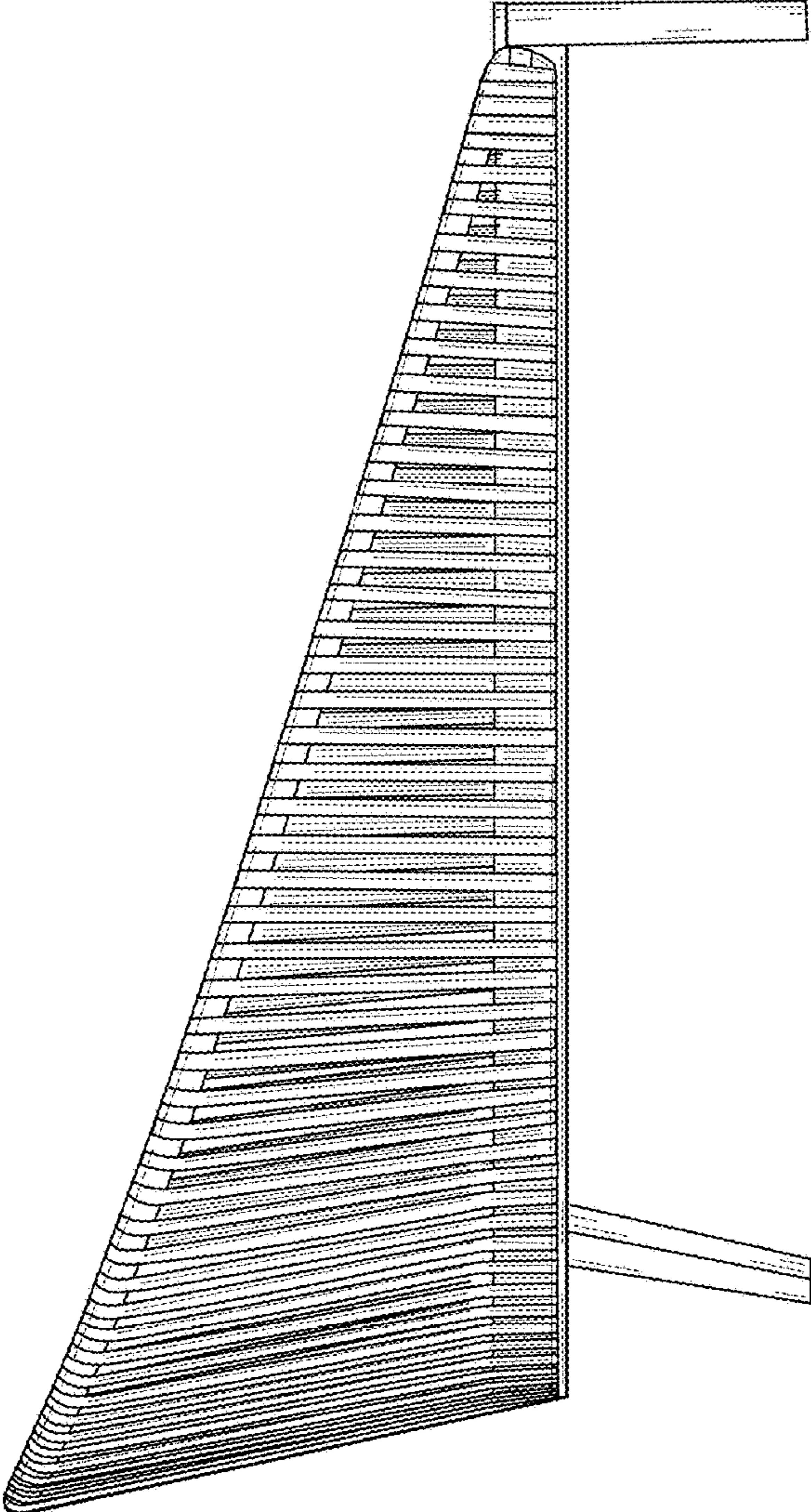

FIG. 4

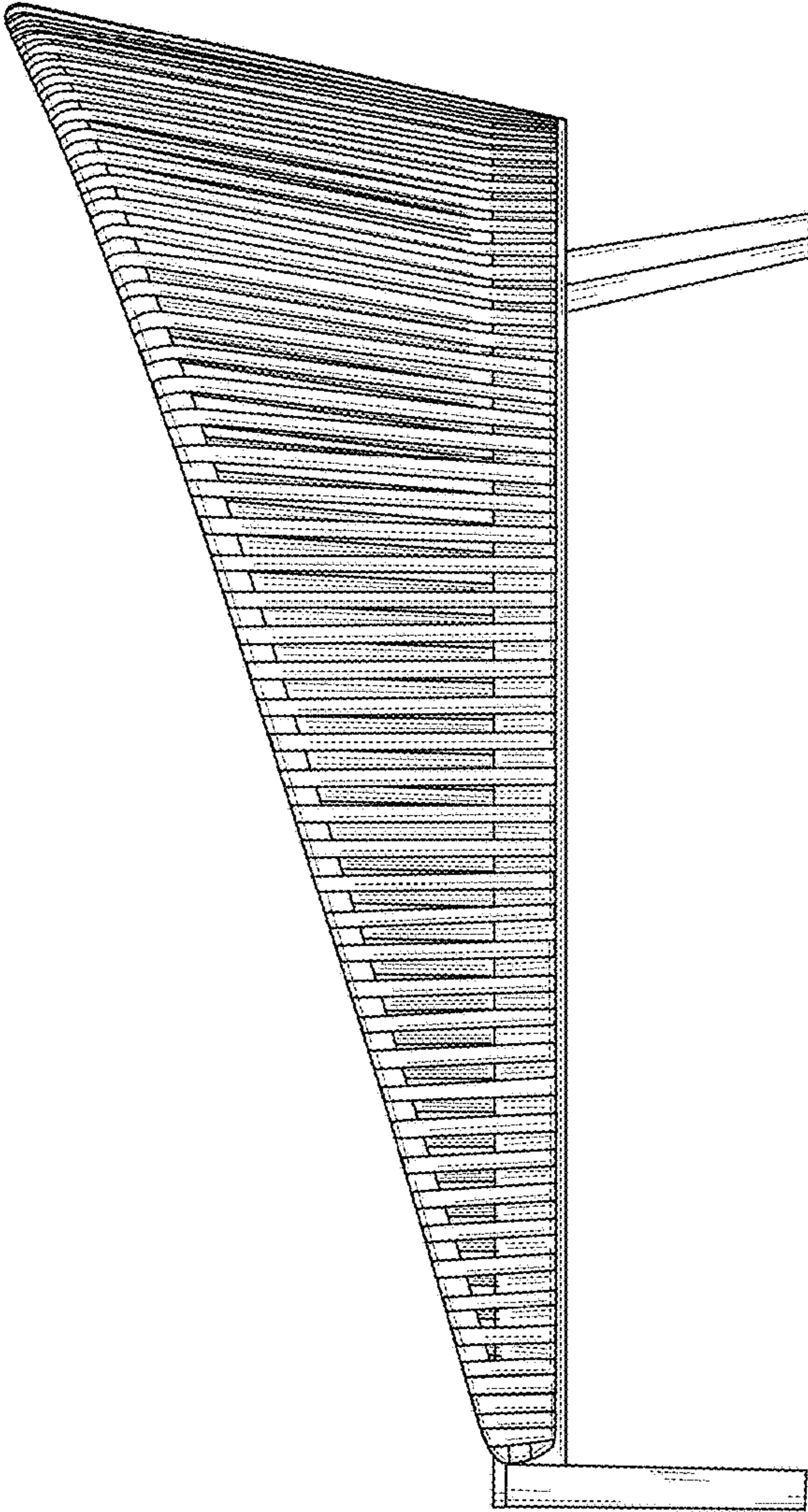

FIG. 5

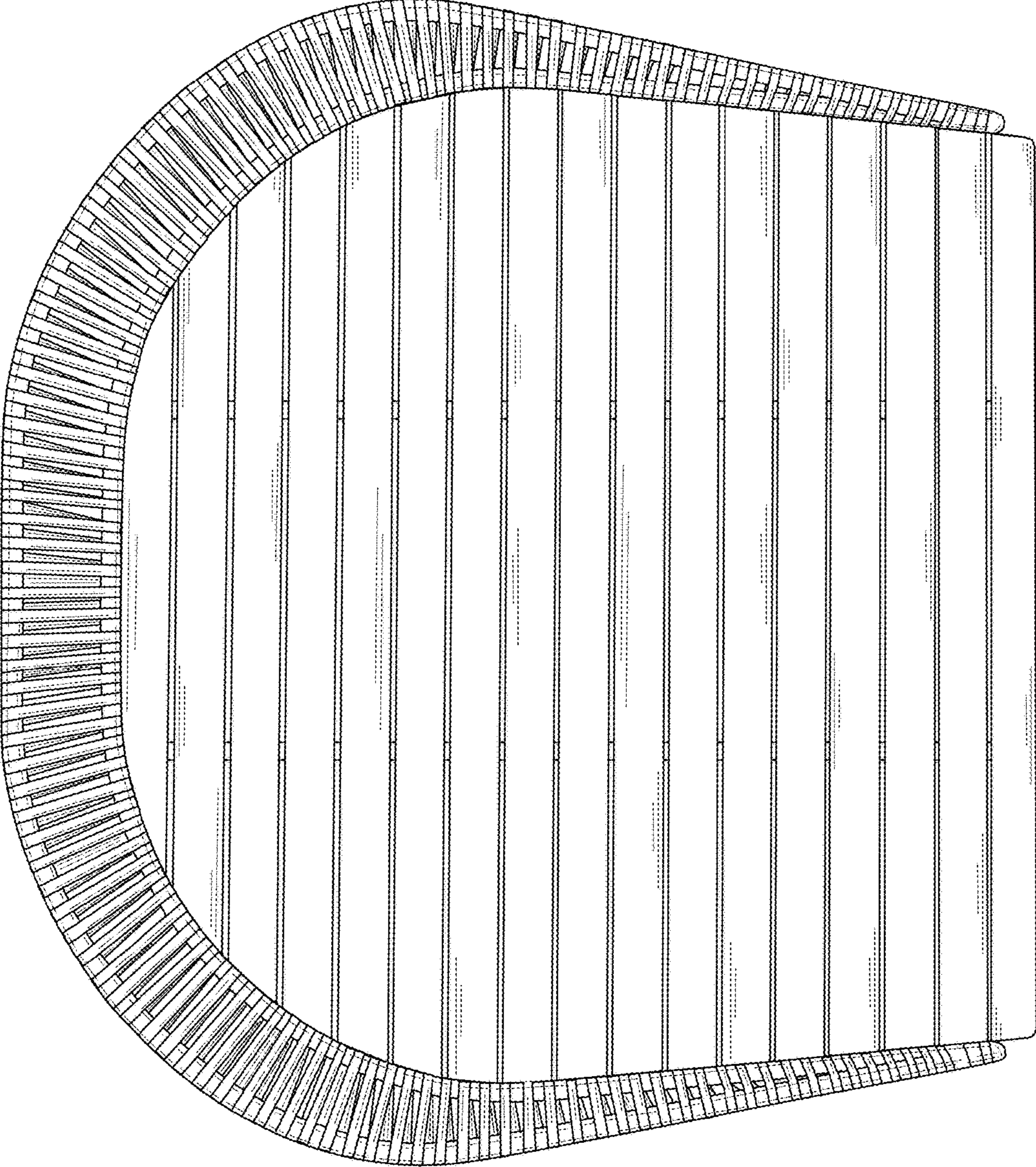

FIG. 6

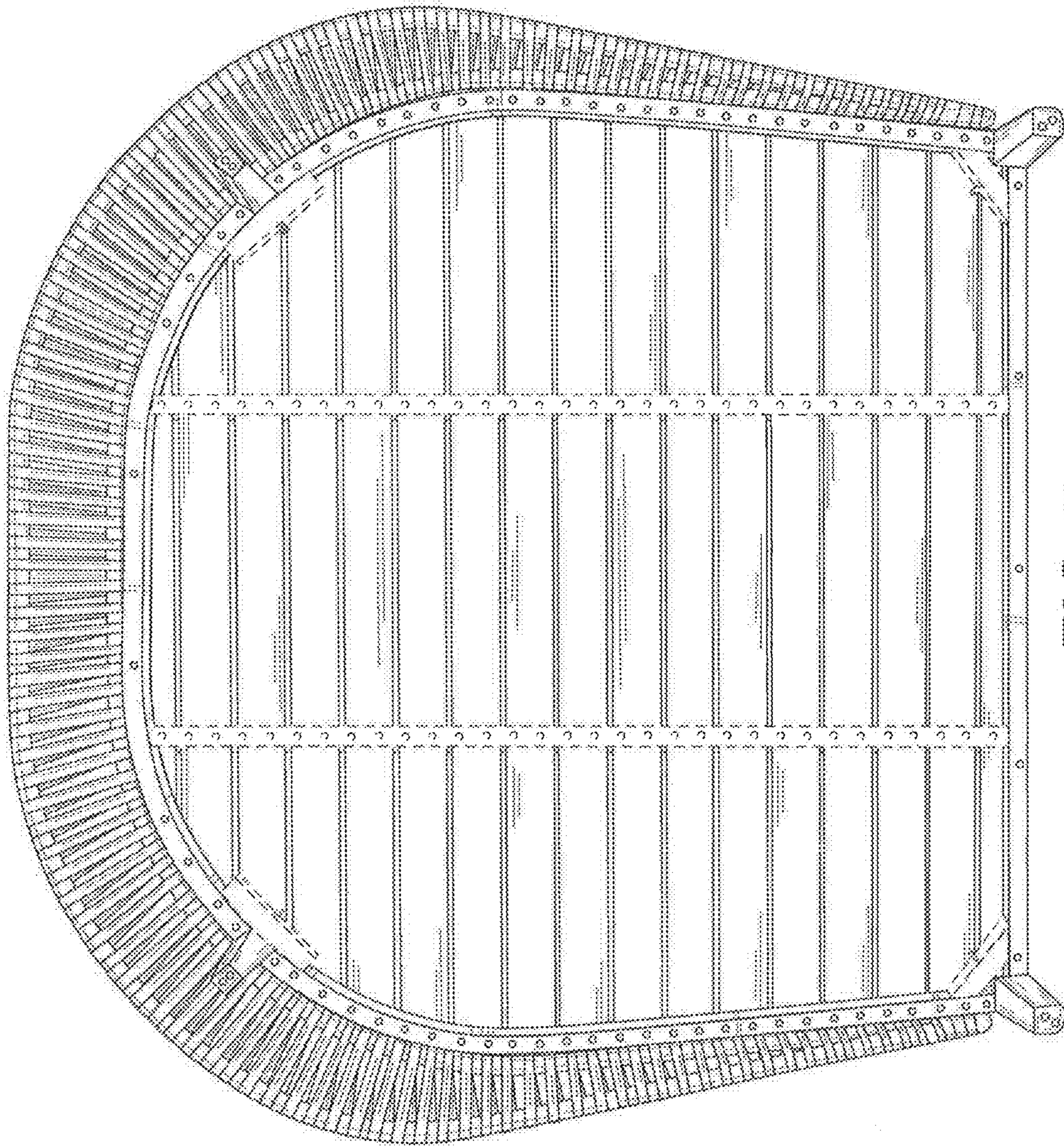

FIG. 7