



US00D855276S

(12) **United States Design Patent**
Li et al.

(10) **Patent No.:** **US D855,276 S**
(45) **Date of Patent:** **** Jul. 30, 2019**

- (54) **TRACTOR**
- (71) Applicant: **BYD COMPANY LIMITED**,
Shenzhen, Guangdong (CN)
- (72) Inventors: **Yuyou Li**, Shenzhen (CN); **Chan Chen**, Shenzhen (CN); **Shaohua Wen**, Shenzhen (CN); **Baowei Cao**, Shenzhen (CN)
- (73) Assignee: **BYD COMPANY LIMITED**,
Shenzhen (CN)

D373,888 S *	9/1996	Soederberg	D34/34
D379,020 S *	4/1997	Avitan	D34/34
D407,176 S *	3/1999	Henshaw	D34/34
D542,005 S *	5/2007	Weiner	D34/34
D562,525 S *	2/2008	Graf	D34/34
D585,623 S *	1/2009	Quinlan, Jr.	D34/34
D608,074 S *	1/2010	Berger	D34/34
D608,075 S *	1/2010	Berger	D34/34
D608,521 S *	1/2010	Berger	D34/34
D608,522 S *	1/2010	Berger	D34/34
D730,614 S *	5/2015	Wu	D34/34
D750,339 S *	2/2016	Miggels	D34/35
D756,589 S *	5/2016	Knier	D34/34

- (**) Term: **15 Years**
- (21) Appl. No.: **29/645,365**
- (22) Filed: **Apr. 25, 2018**

* cited by examiner

Primary Examiner — Mark A Goodwin
(74) *Attorney, Agent, or Firm* — Calfee, Halter & Griswold LLP; Joshua Friedman; Yizhou Liu

(30) **Foreign Application Priority Data**

Oct. 31, 2017 (CN) 2017 3 0525345

- (51) **LOC (11) Cl.** **12-05**
- (52) **U.S. Cl.**

USPC **D34/34**

(58) **Field of Classification Search**

USPC D34/34, 35, 28; D12/85, 8, 11, 14, 56,
D12/57; 187/222, 234, 226, 238, 631,
187/575, 592; 414/631, 575, 592;
180/89.12, 89.13, 89.17

CPC B66F 9/24; B66F 9/08; B66F 9/07563;
B66F 9/075; B66F 9/082; B66F 9/122;
B66F 9/146; B66F 9/0755

See application file for complete search history.

(56) **References Cited**

U.S. PATENT DOCUMENTS

- D262,613 S * 1/1982 Frees D34/34
- D324,006 S * 2/1992 Oslapas D12/1

(57) **CLAIM**

We claim the ornamental design for a tractor, as shown and described.

DESCRIPTION

FIG. 1 is a drawing of a front elevational view of a tractor of the present design;
FIG. 2 is a rear elevational view thereof;
FIG. 3 is a right side elevational view thereof;
FIG. 4 is a left side elevational view thereof;
FIG. 5 is a top plan view thereof;
FIG. 6 is a top/front/left perspective view thereof; and,
FIG. 7 is a top/rear/left perspective view thereof.
The bottom view forms no part of the claimed design. The drawings include surface shading that represents contour and not surface ornamentation.

1 Claim, 7 Drawing Sheets

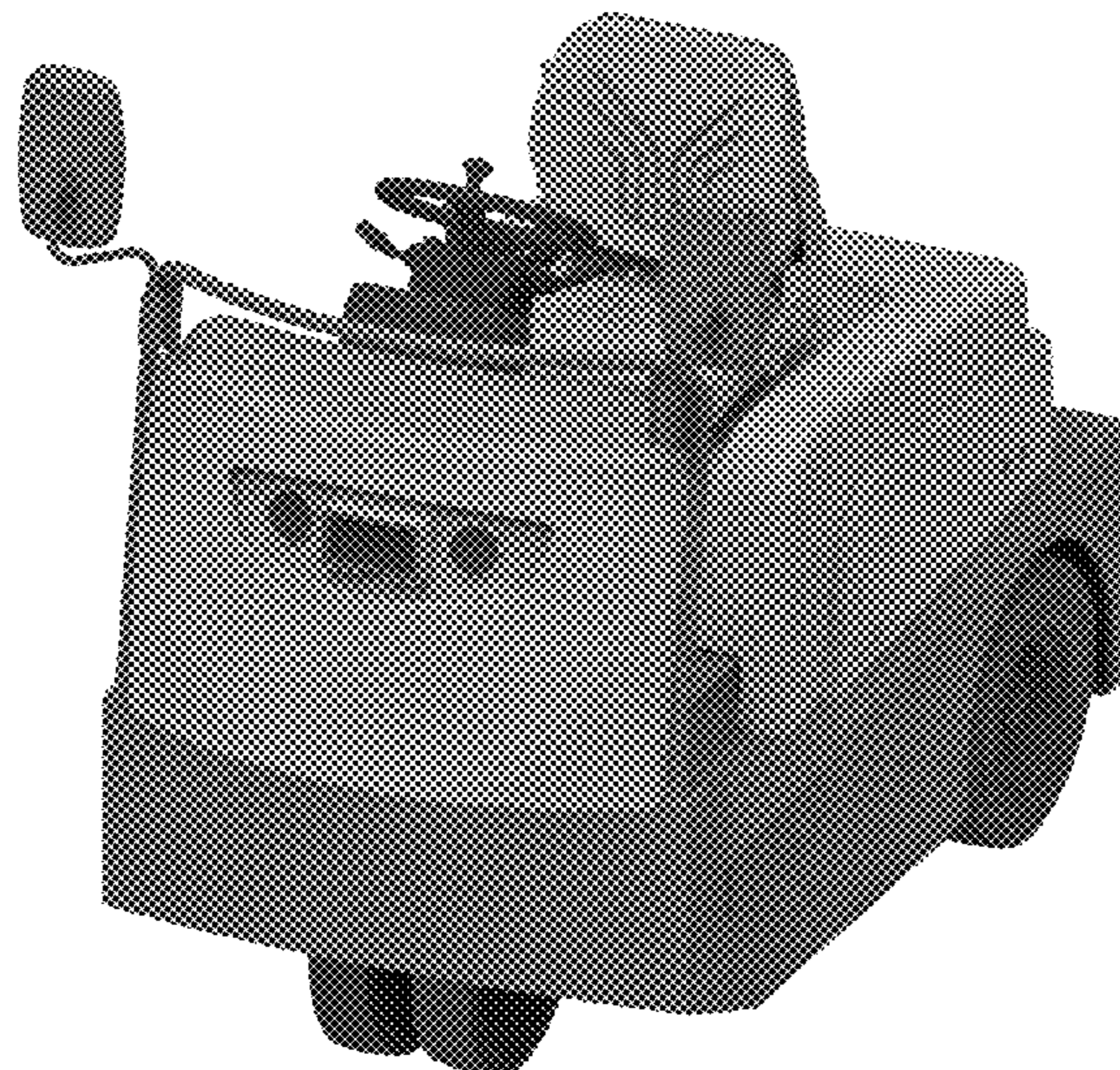

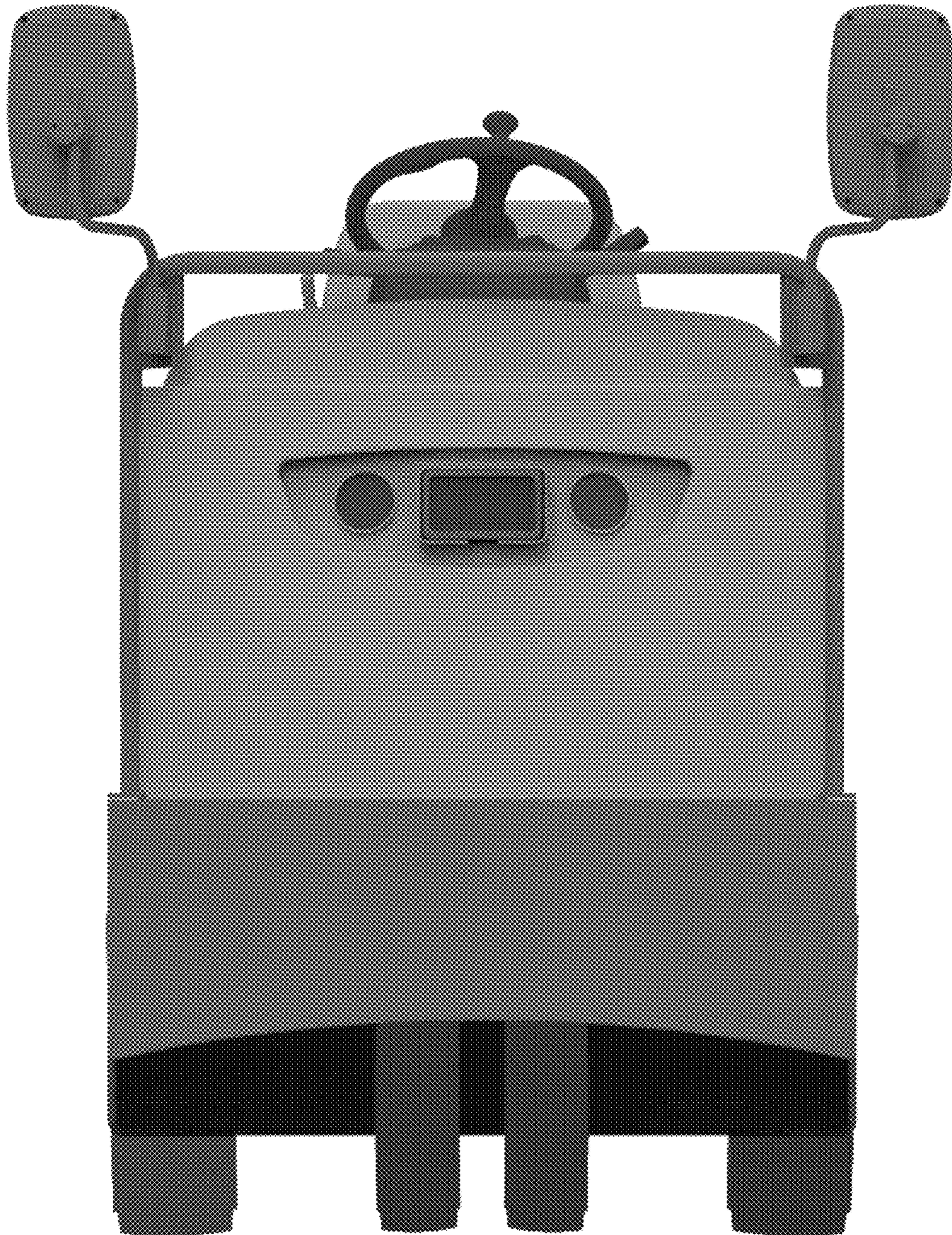

FIG. 1

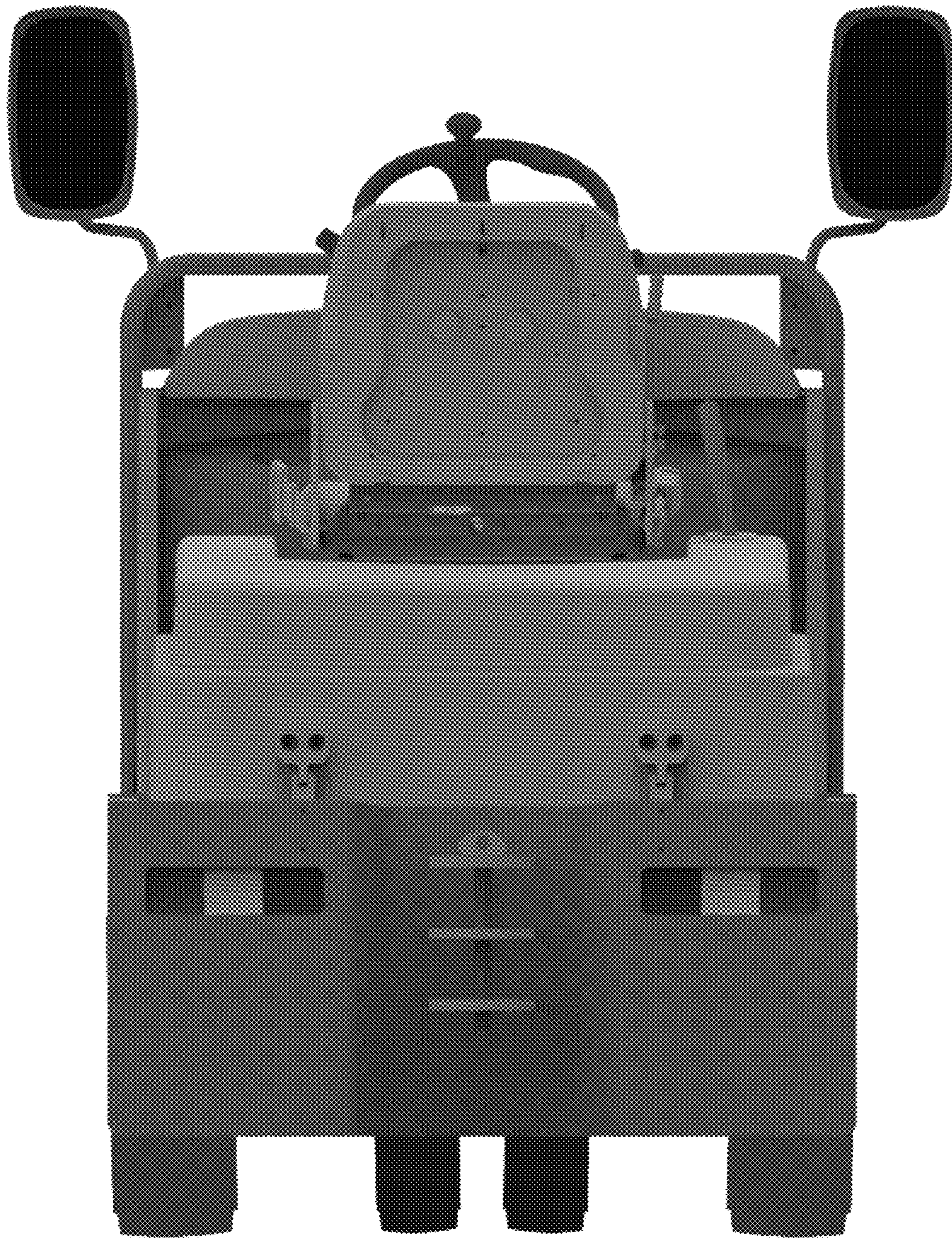

FIG. 2

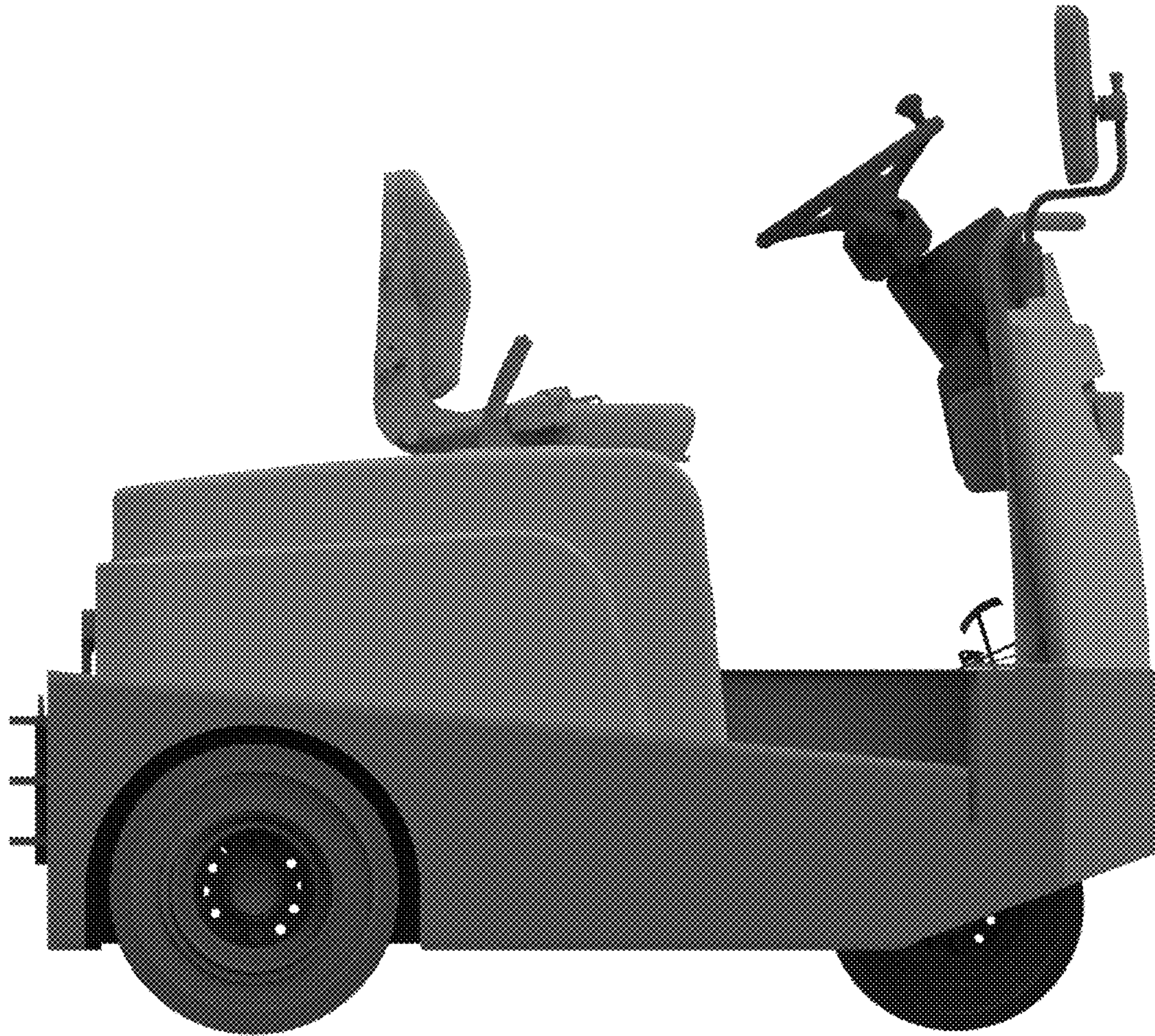

FIG. 3

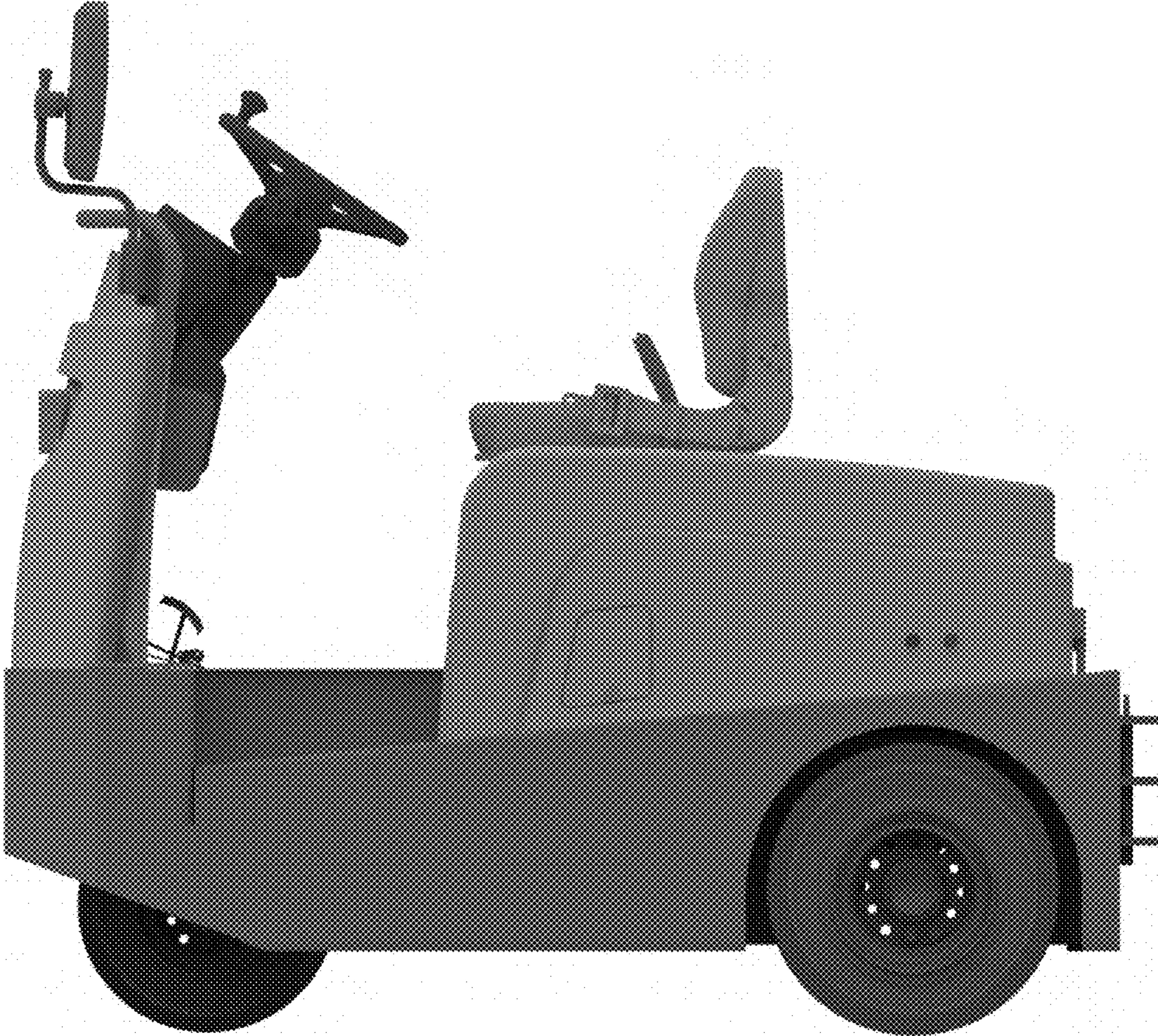

FIG. 4

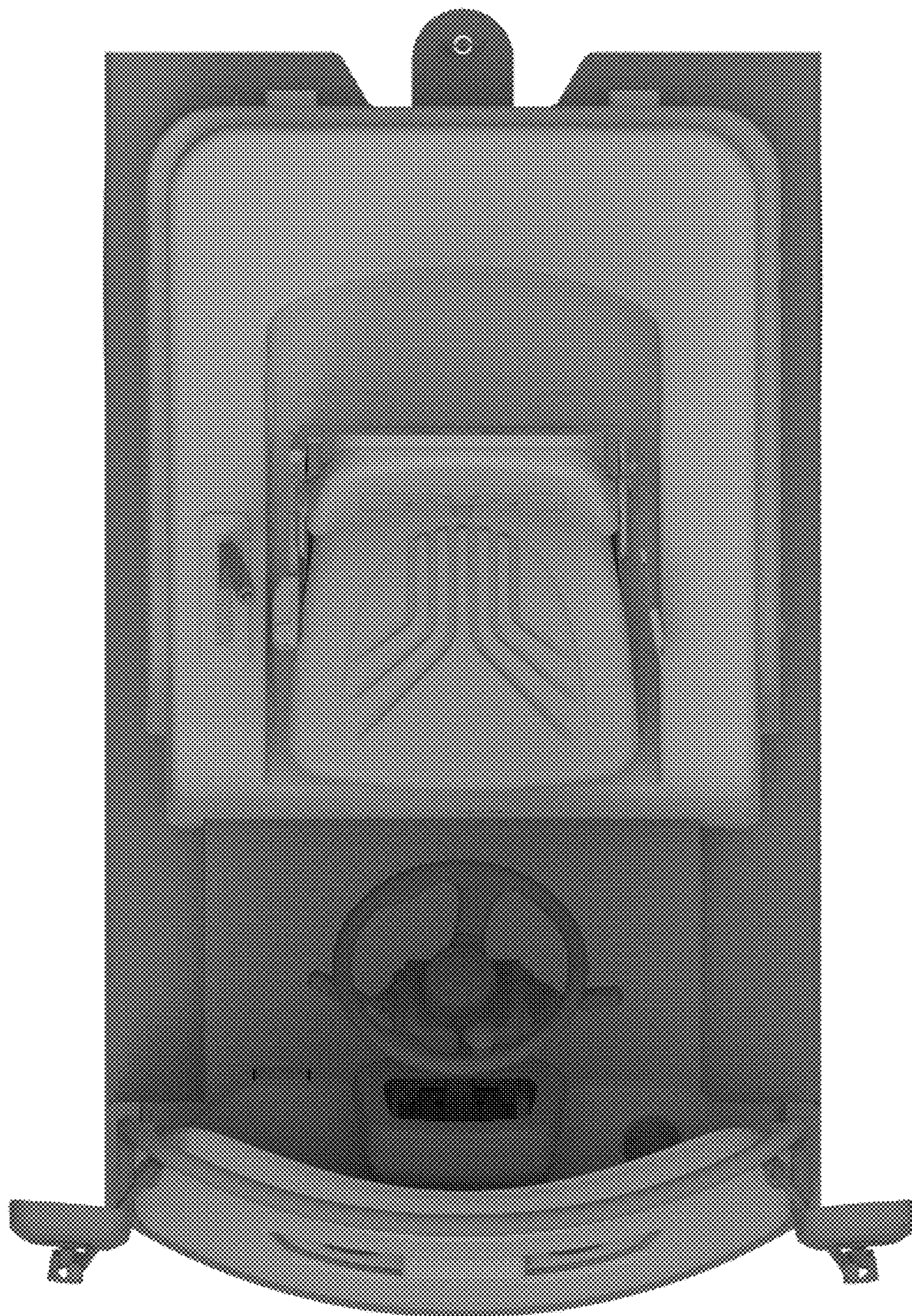

FIG. 5

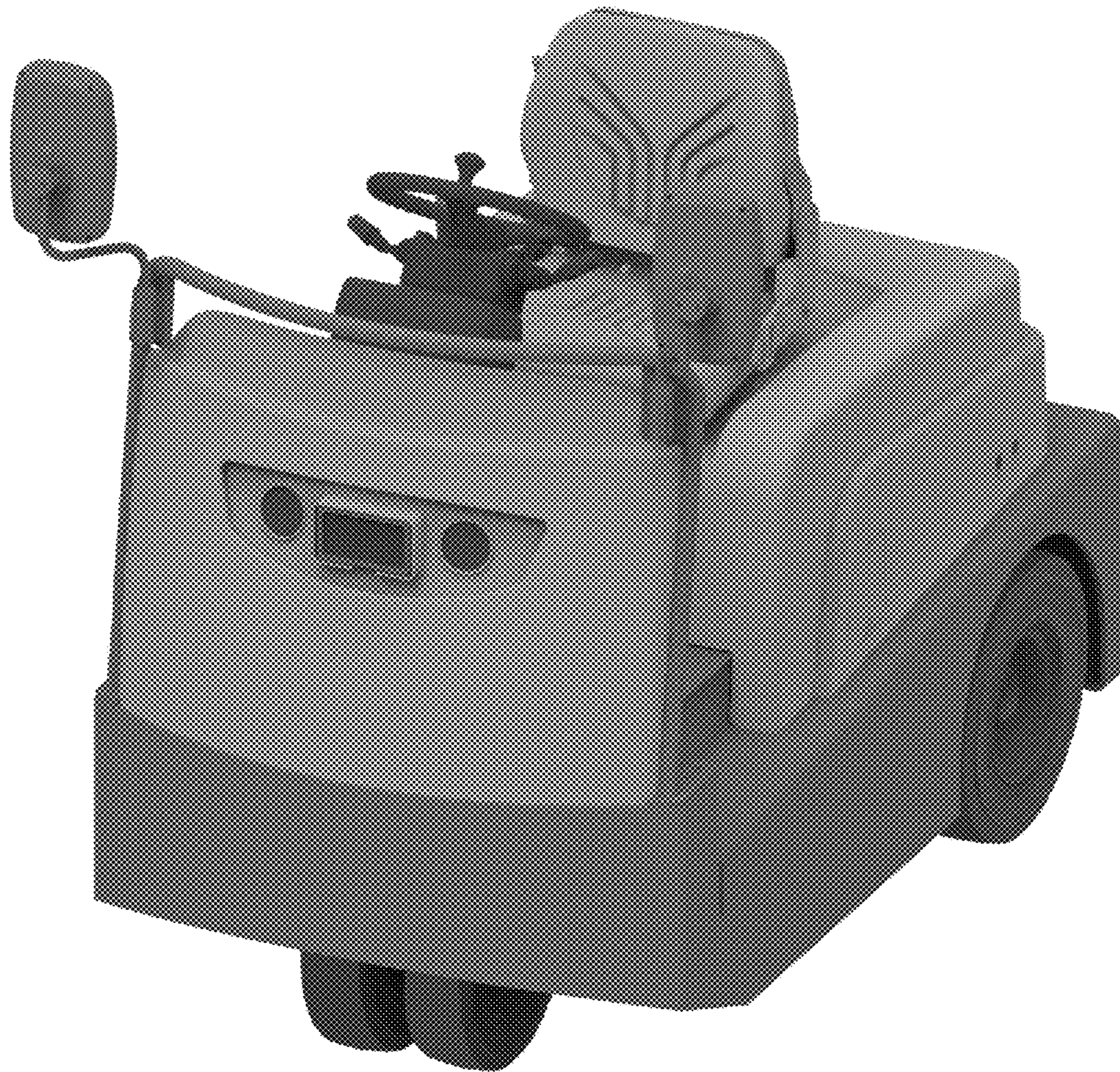

FIG. 6



FIG. 7