



US00D855259S

(12) **United States Design Patent**
Rathman et al.

(10) **Patent No.:** **US D855,259 S**

(45) **Date of Patent:** **** Jul. 30, 2019**

(54) **PET KENNEL FURNITURE**

(71) Applicant: **B&B Kustom Kennels LLC**, Larkspur, CO (US)

(72) Inventors: **Bethany Rathman**, Parker, CO (US);
Brody Rathman, Parker, CO (US)

(73) Assignee: **B&B Kustom Kennels LLC**, Larkspur, CO (US)

(**) Term: **15 Years**

(21) Appl. No.: **29/640,399**

(22) Filed: **Mar. 14, 2018**

Related U.S. Application Data

(63) Continuation-in-part of application No. 29/558,767, filed on Mar. 21, 2016, now Pat. No. Des. 821,038.

(51) **LOC (11) Cl.** **30-02**

(52) **U.S. Cl.**
USPC **D30/114**

(58) **Field of Classification Search**
USPC D30/108, 112, 114, 116; D6/657, 671, D6/671.1

(Continued)

(56) **References Cited**

U.S. PATENT DOCUMENTS

D176,930 S 2/1956 Saba
D211,774 S 7/1968 Verner et al.

(Continued)

FOREIGN PATENT DOCUMENTS

GR 6004204-0001 9/2017
GR 6004204-003 9/2017

(Continued)

Primary Examiner — Janice Hallmark

(74) *Attorney, Agent, or Firm* — Trenner Law Firm, LLC; Mark D. Trenner

(57) **CLAIM**

The ornamental design for a pet kennel furniture, substantially as shown and described.

DESCRIPTION

FIG. 1 is a top perspective view of a pet kennel furniture showing our new design;

FIG. 2 is a front view of the design corresponding to FIG. 1;

FIG. 3 is a back view of the design corresponding to FIG. 1;

FIG. 4 is a top view of the design corresponding to FIG. 1;

FIG. 5 is a bottom view of the design corresponding to FIG. 1;

FIG. 6 is a left side view of the design corresponding to FIG. 1;

FIG. 7 is a right side view of the design corresponding to FIG. 1;

FIG. 8 is another top perspective view of the design corresponding to FIG. 1 with the sliding door shown in an open position;

FIG. 9 is a top perspective view of a second embodiment of FIG. 1 showing the locks on the sides of the doors;

FIG. 10 is a front view of the design corresponding to FIG. 9;

FIG. 11 is a back view of the design corresponding to FIG. 9;

FIG. 12 is a top view of the design corresponding to FIG. 9;

FIG. 13 is a bottom view of the design corresponding to FIG. 9;

FIG. 14 is a left side view of the design corresponding to FIG. 9;

FIG. 15 is a right side view of the design corresponding to FIG. 9; and,

FIG. 16 is another top perspective view of the design corresponding to FIG. 9 with the sliding door shown in an open position.

The broken lines depict environmental subject matter and form no part of the claimed design.

1 Claim, 14 Drawing Sheets

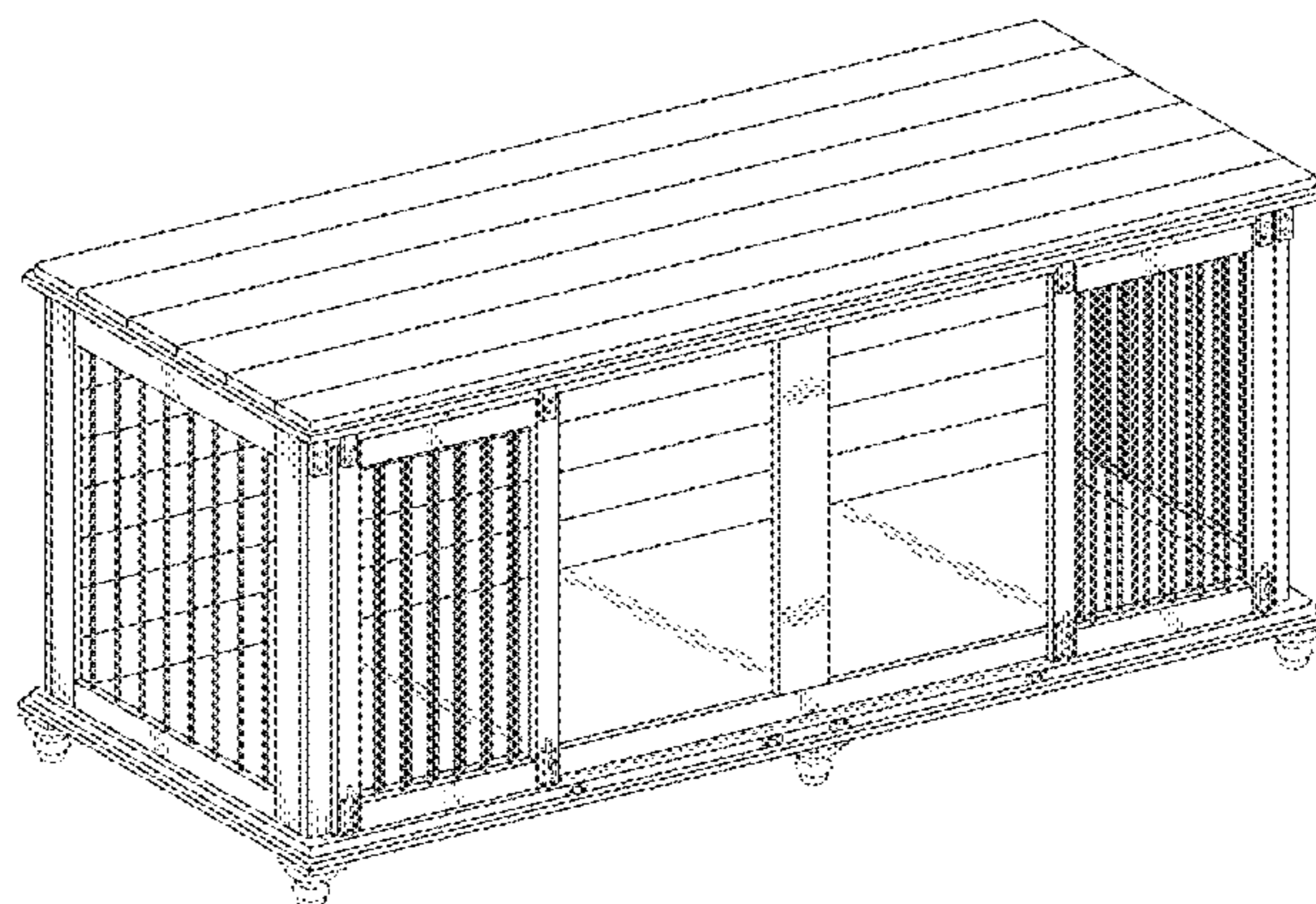

US D855,259 S

Page 2

(58) **Field of Classification Search**
CPC A01K 1/033; A01K 1/034; A01K 1/035;
A01K 1/0218
See application file for complete search history.

(56) **References Cited**

U.S. PATENT DOCUMENTS

D274,152 S 6/1984 Fleming
D320,516 S 10/1991 Grey
D330,274 S 10/1992 Smith et al.
D360,491 S 7/1995 Campbell
D432,818 S 10/2000 Hutton
6,286,458 B1 9/2001 Rawson
D483,156 S 12/2003 Simpson
D519,685 S 4/2006 Scarpaci et al.
D520,190 S * 5/2006 Joyner D30/108
7,234,415 B2 6/2007 Dietz
D554,389 S 11/2007 Pierce et al.
D569,053 S 5/2008 Lee
D582,610 S 12/2008 Warman

D609,407 S 2/2010 Henley et al.
7,681,533 B2 3/2010 Dietz
D616,157 S * 5/2010 Irandi D30/108
D616,617 S 5/2010 Cirincione et al.
D640,837 S 6/2011 Henley et al.
7,997,234 B1 8/2011 Hughey
D650,953 S 12/2011 Lee et al.
D704,901 S 5/2014 Diskin et al.
D723,225 S 2/2015 Lee et al.
D821,038 S 6/2018 Rathman et al.
2002/0152969 A1 10/2002 Grigsby et al.
2006/0112897 A1 6/2006 Moore
2007/0089683 A1 4/2007 Roberts et al.
2009/0031964 A1 2/2009 Proxmire
2017/0097169 A1 4/2017 Azevedo et al.
2017/0188538 A1 7/2017 Rathman et al.

FOREIGN PATENT DOCUMENTS

JP D1059881 2/2000
WO 2008082376 2/2000

* cited by examiner

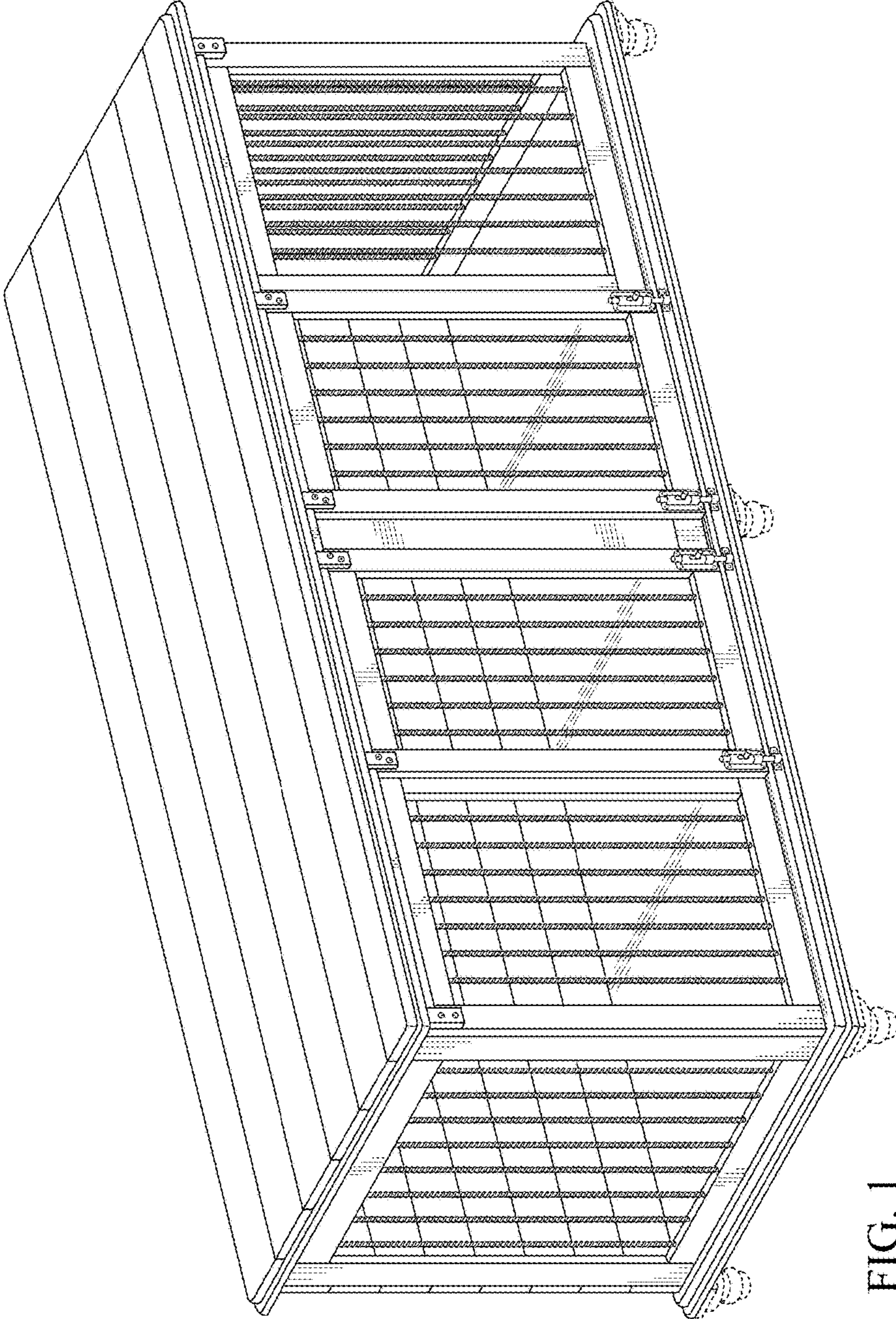

FIG. 1

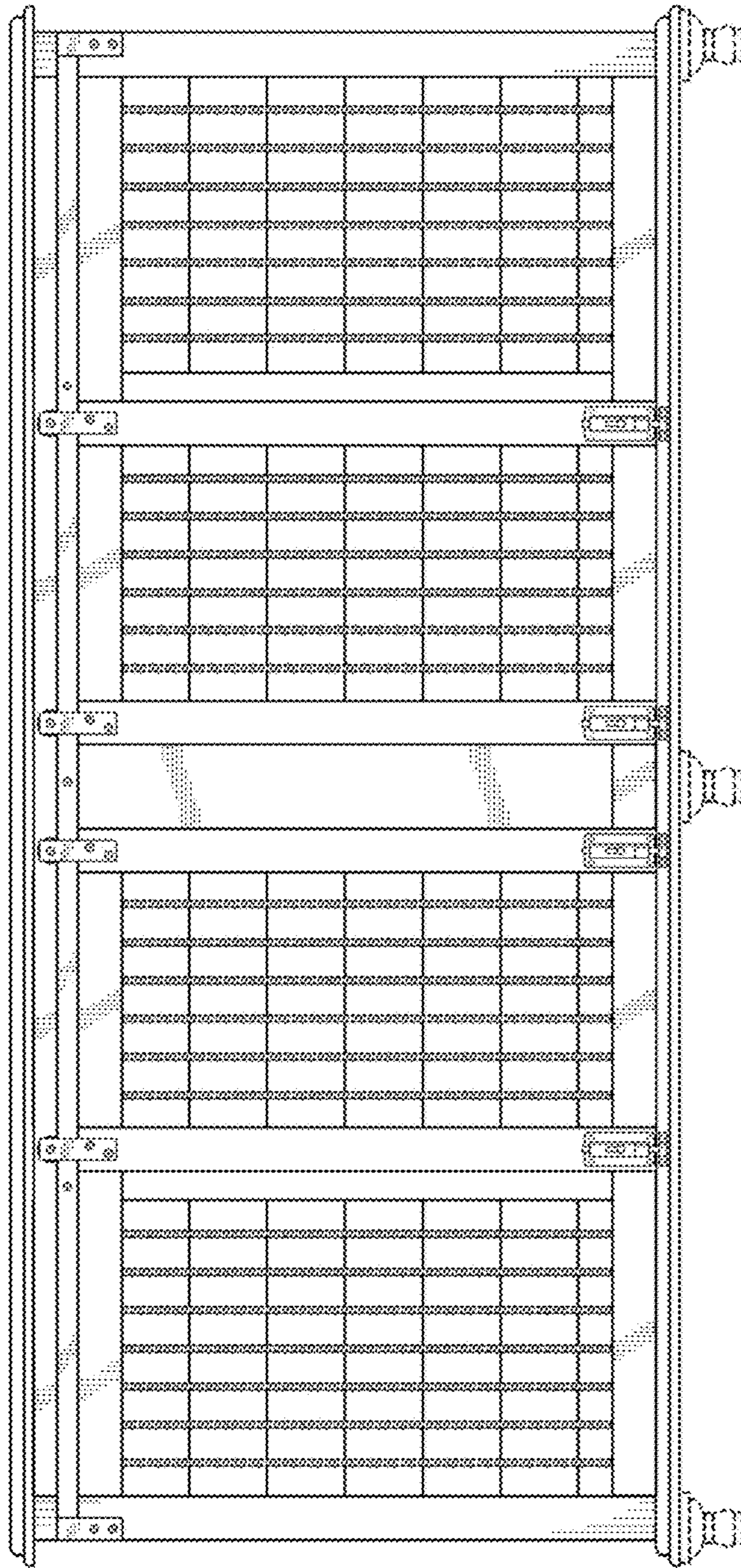

FIG. 2

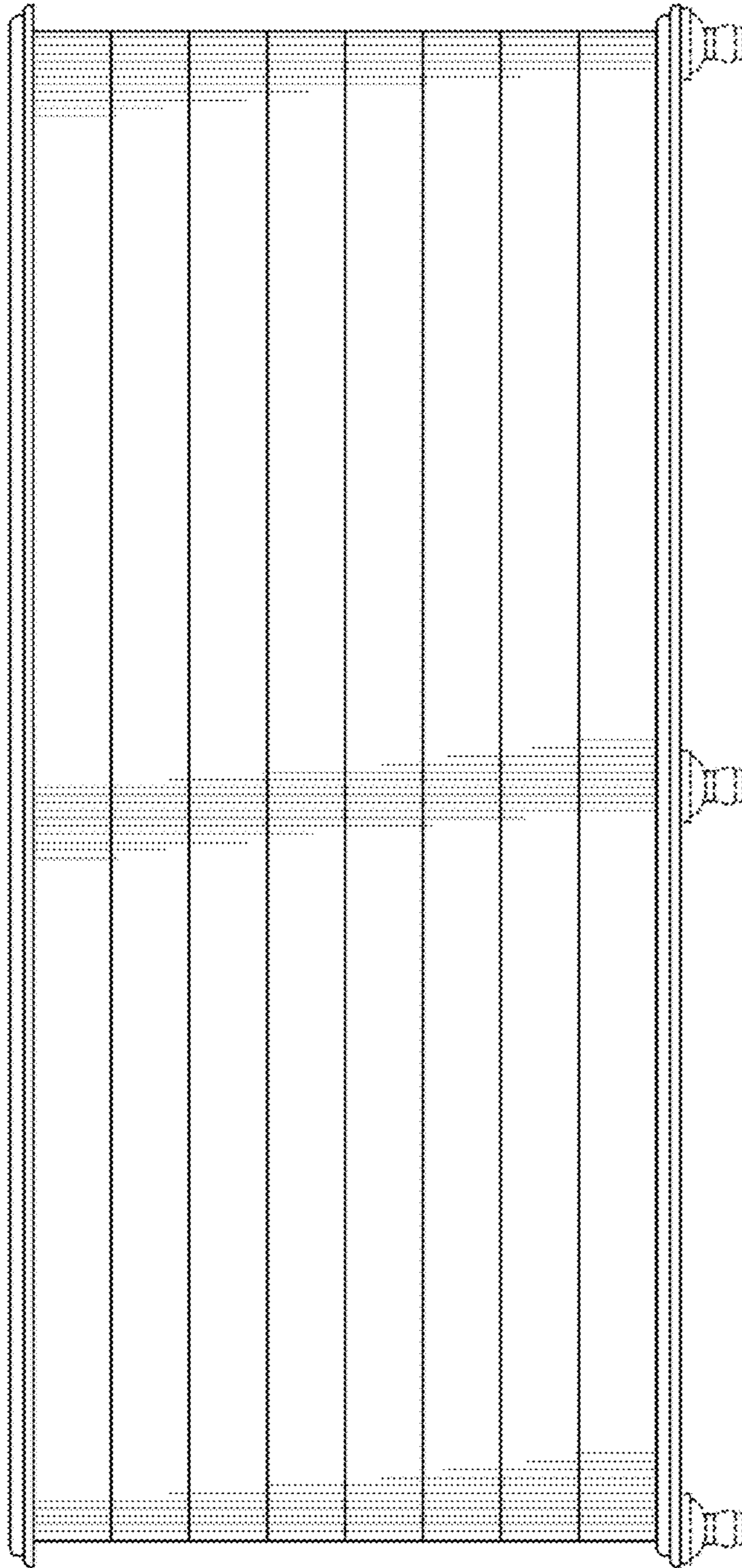

FIG. 3

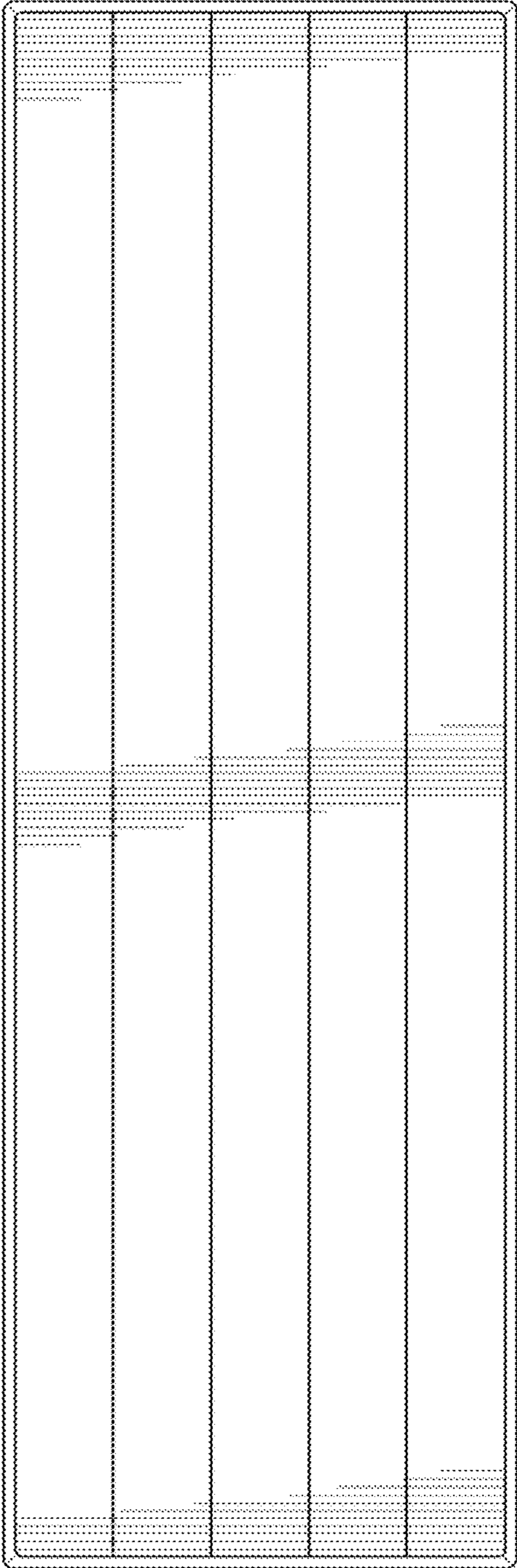

FIG. 4

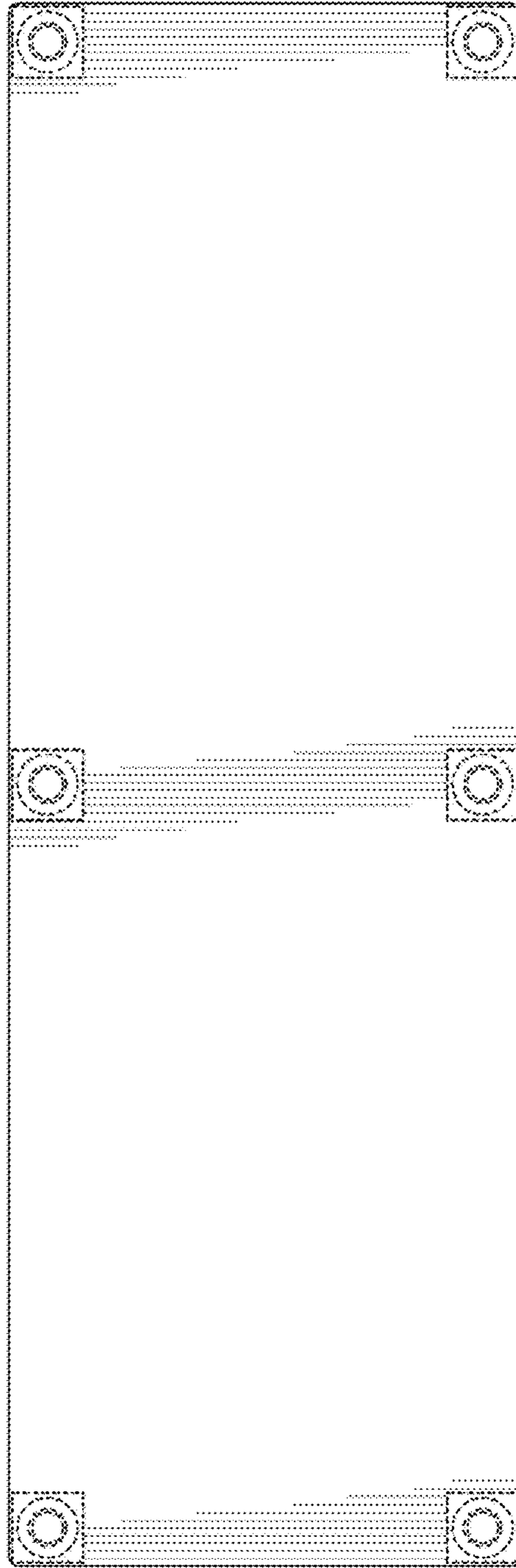

FIG. 5

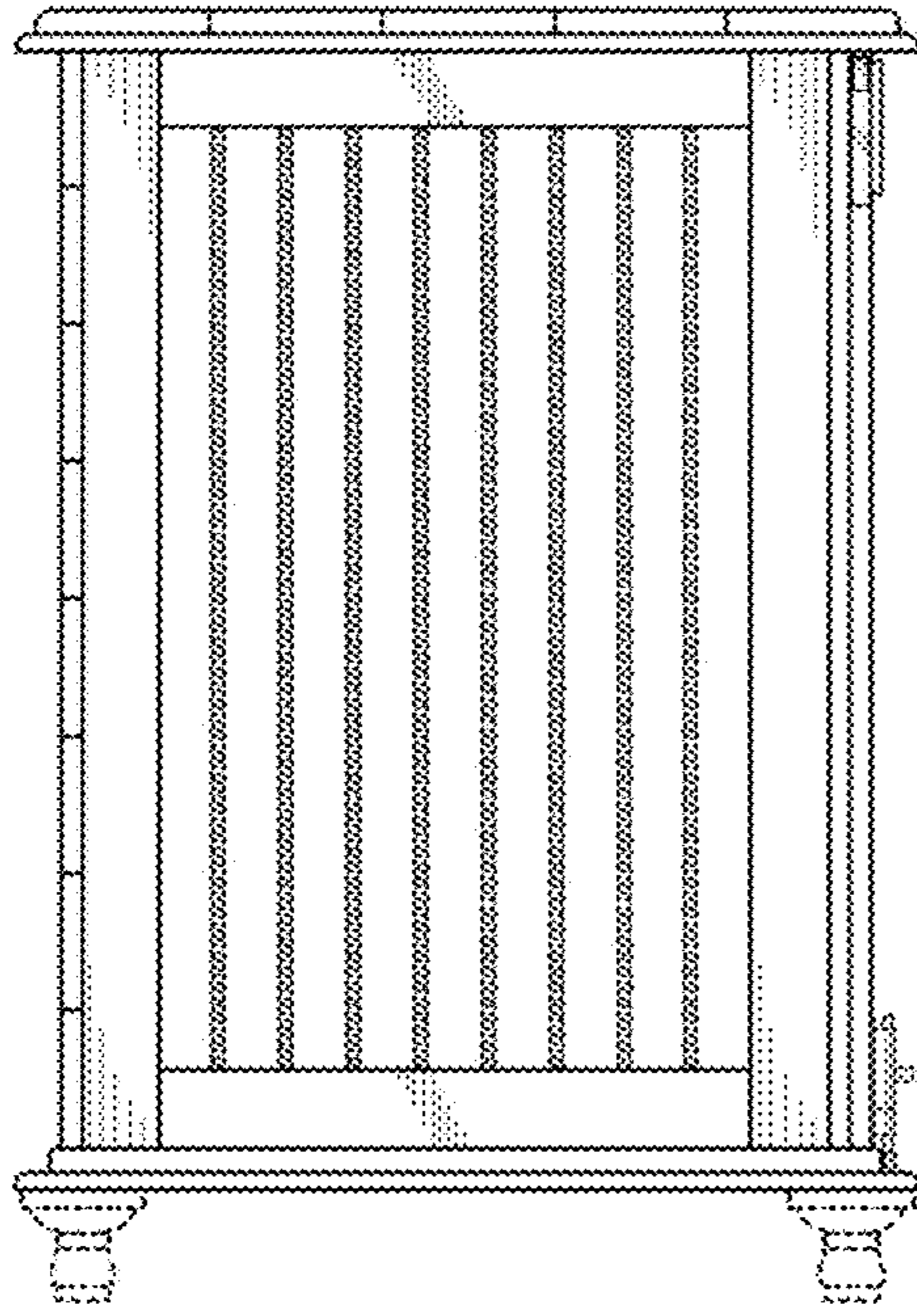

FIG. 6

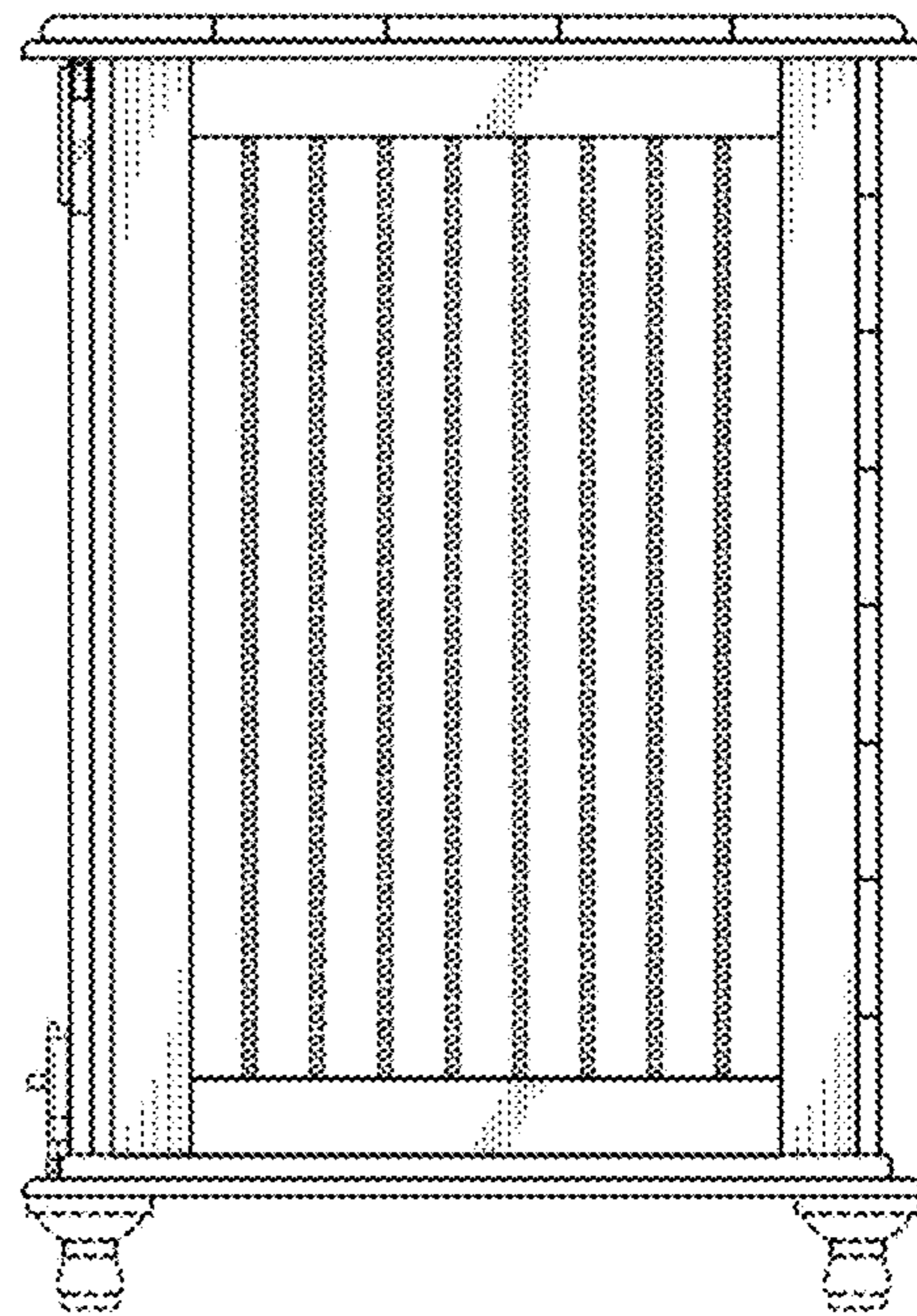

FIG. 7

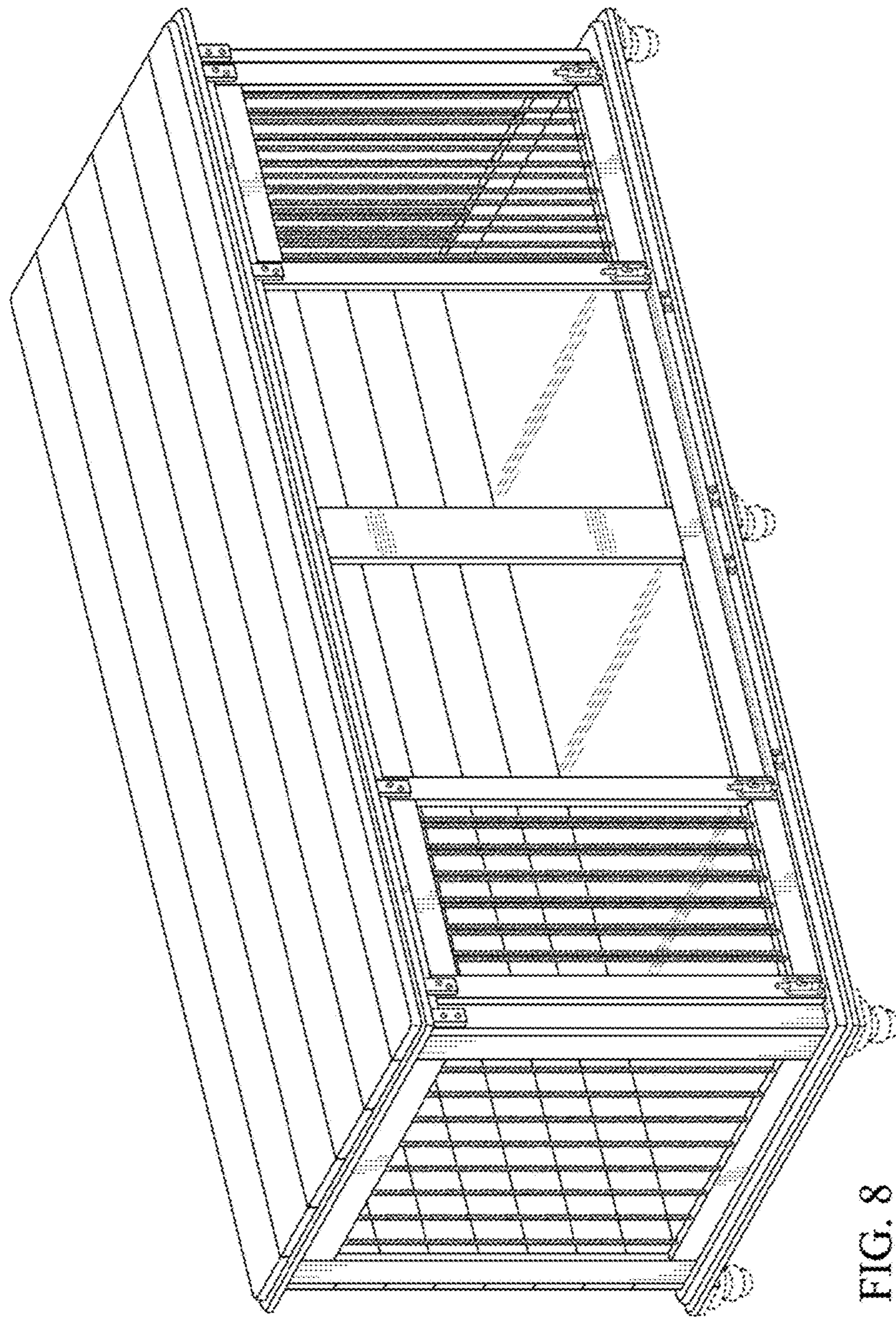

FIG. 8

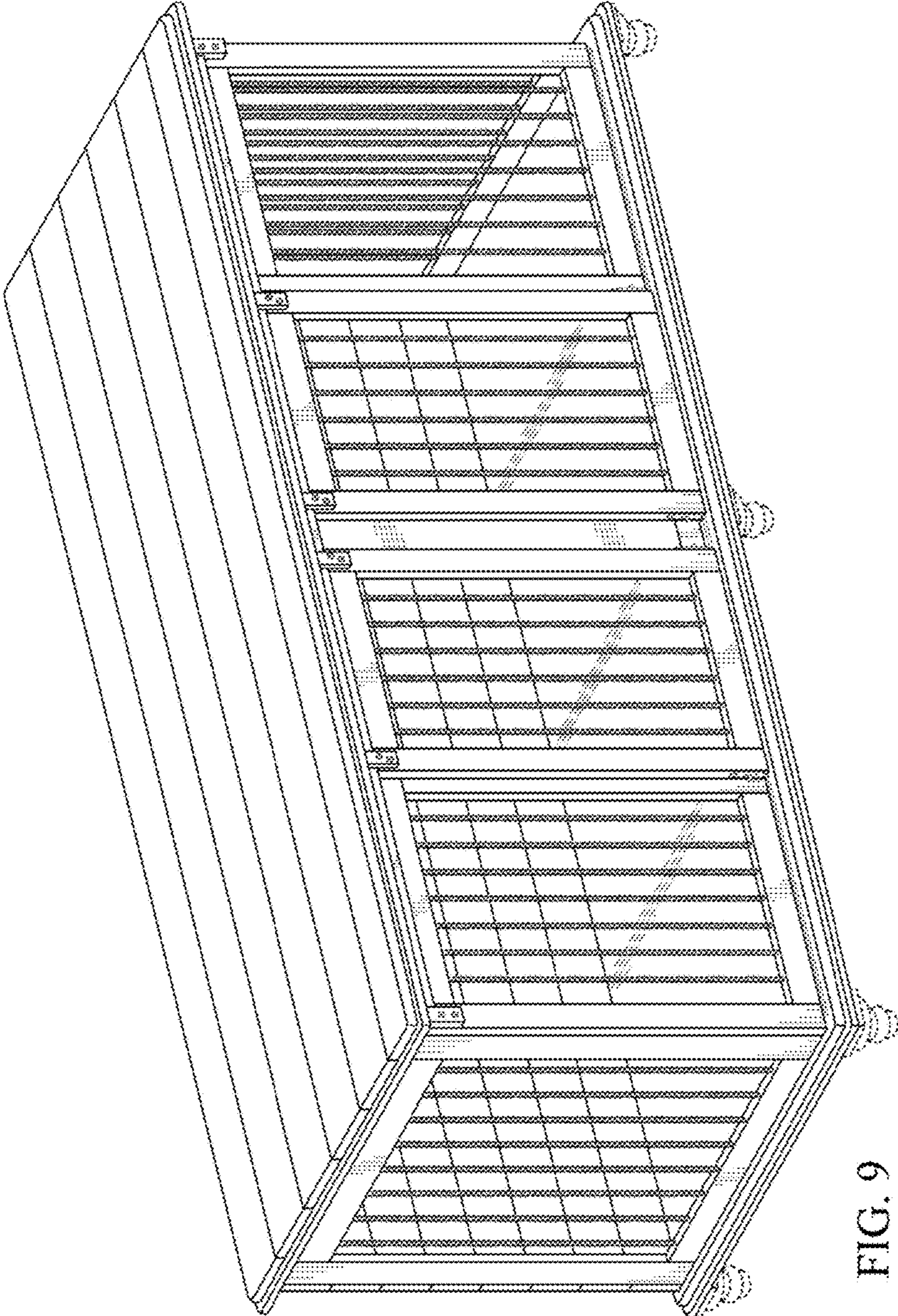

FIG. 9

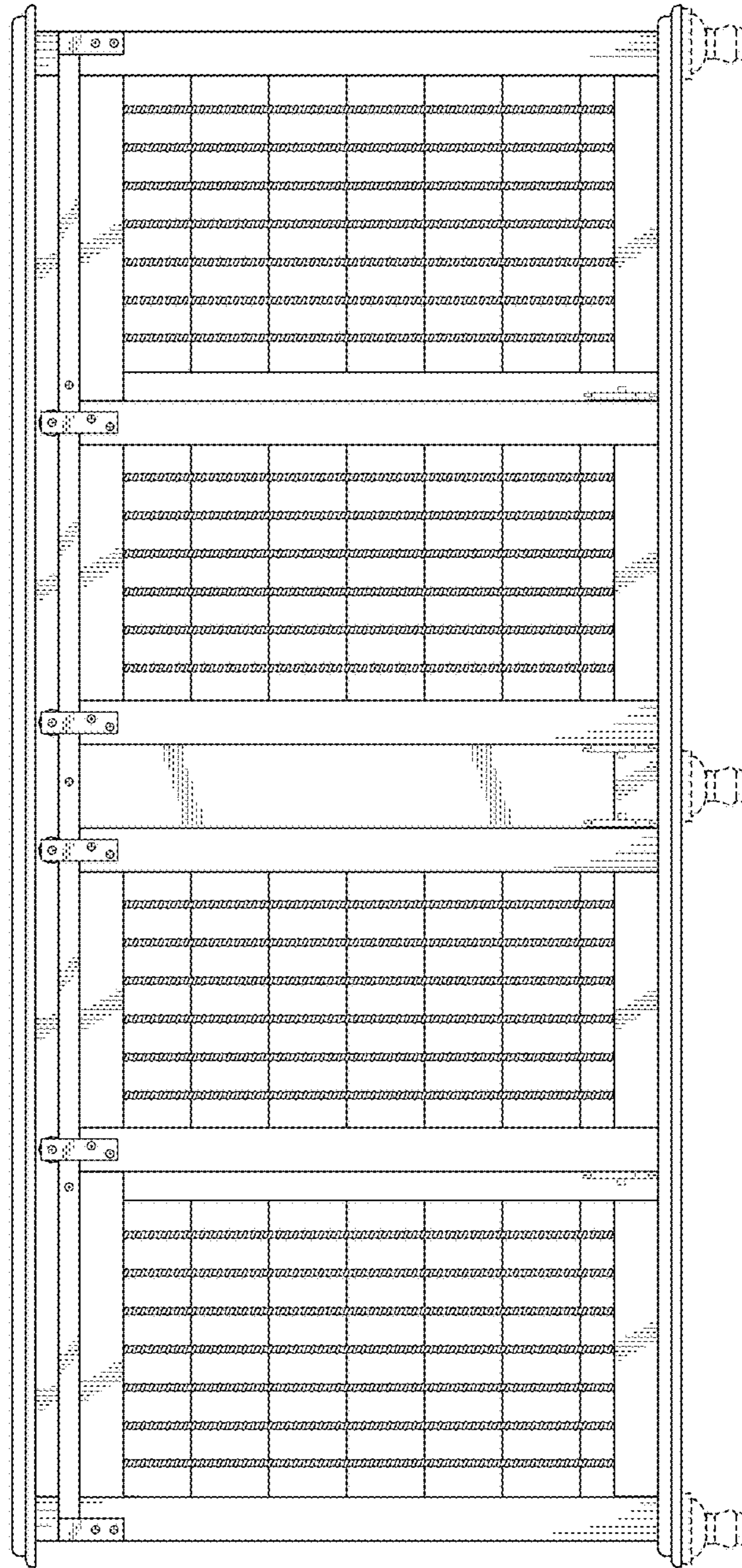

FIG. 10

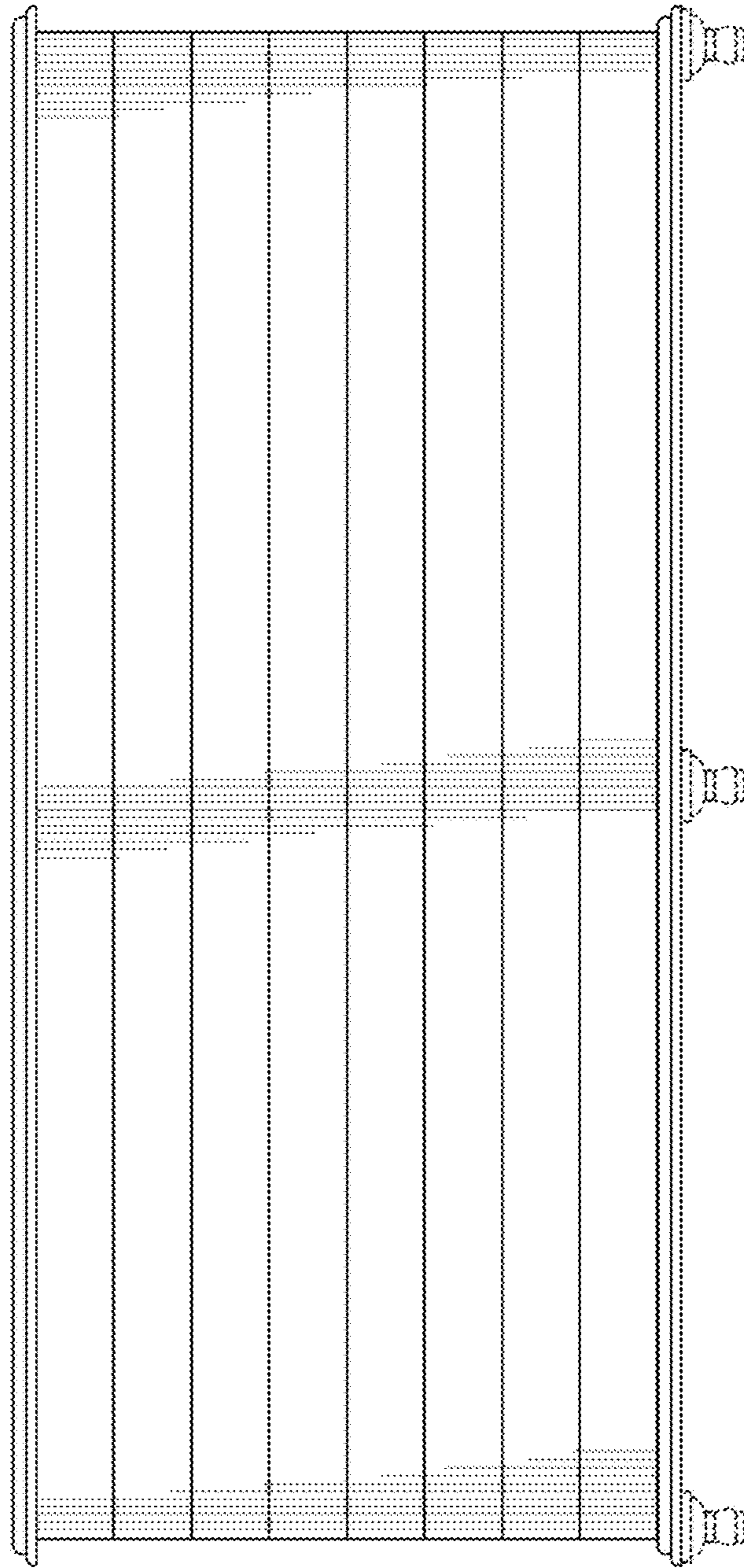

FIG. 11

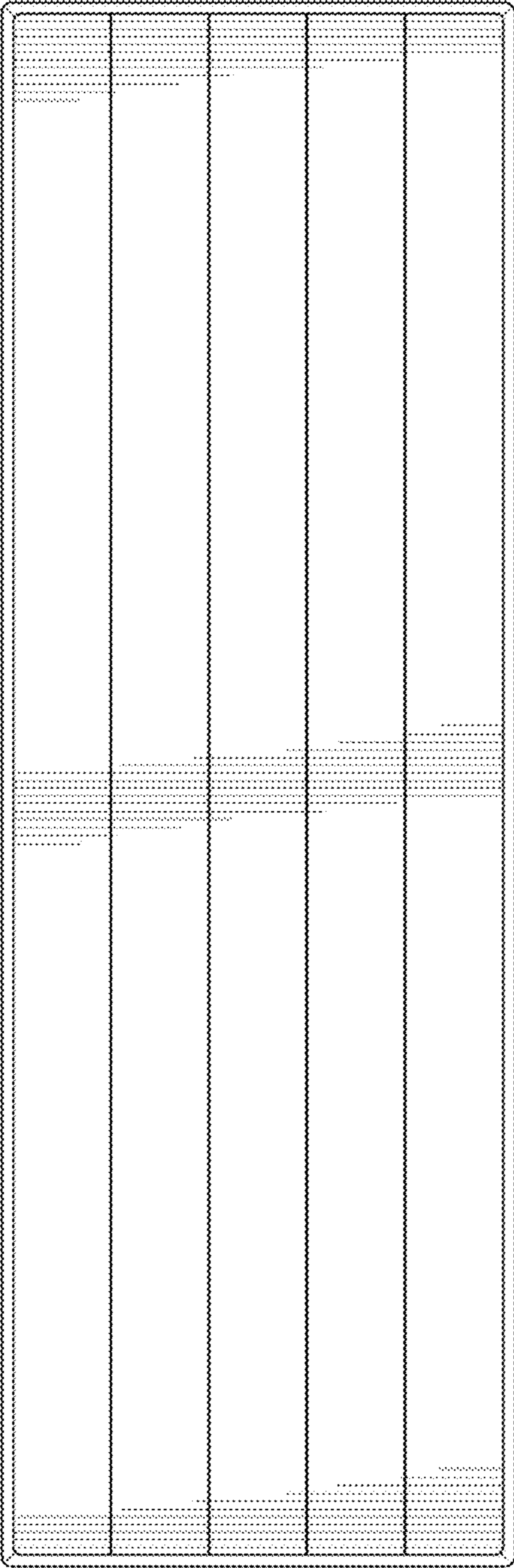

FIG. 12

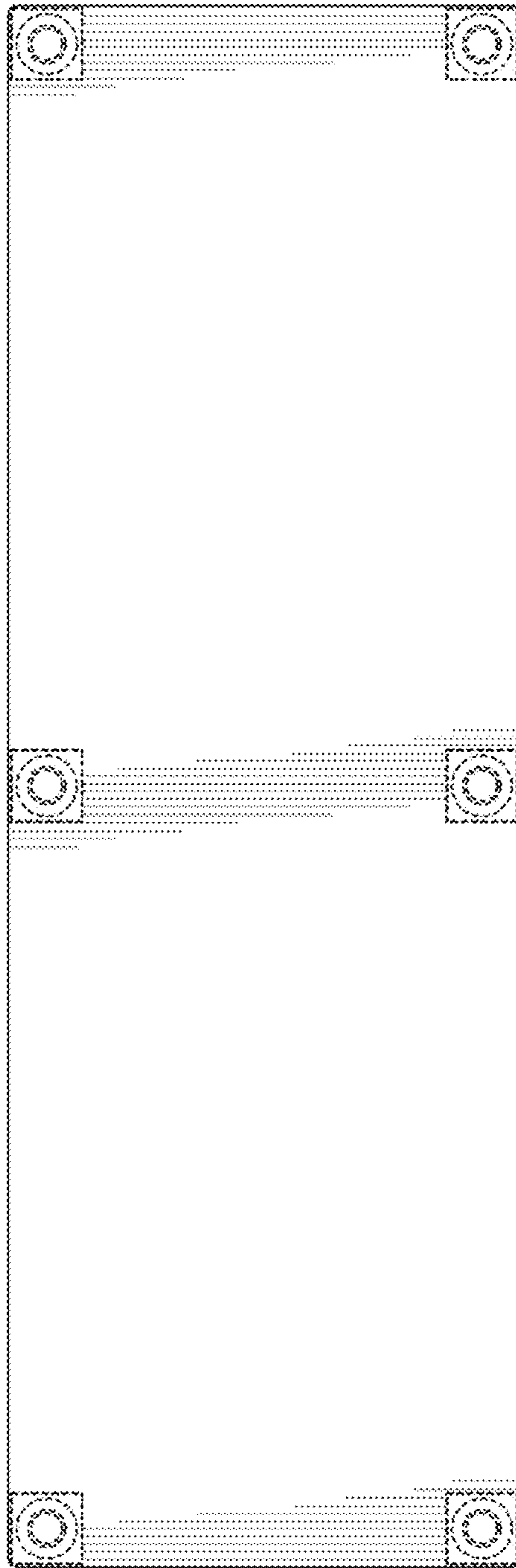

FIG. 13

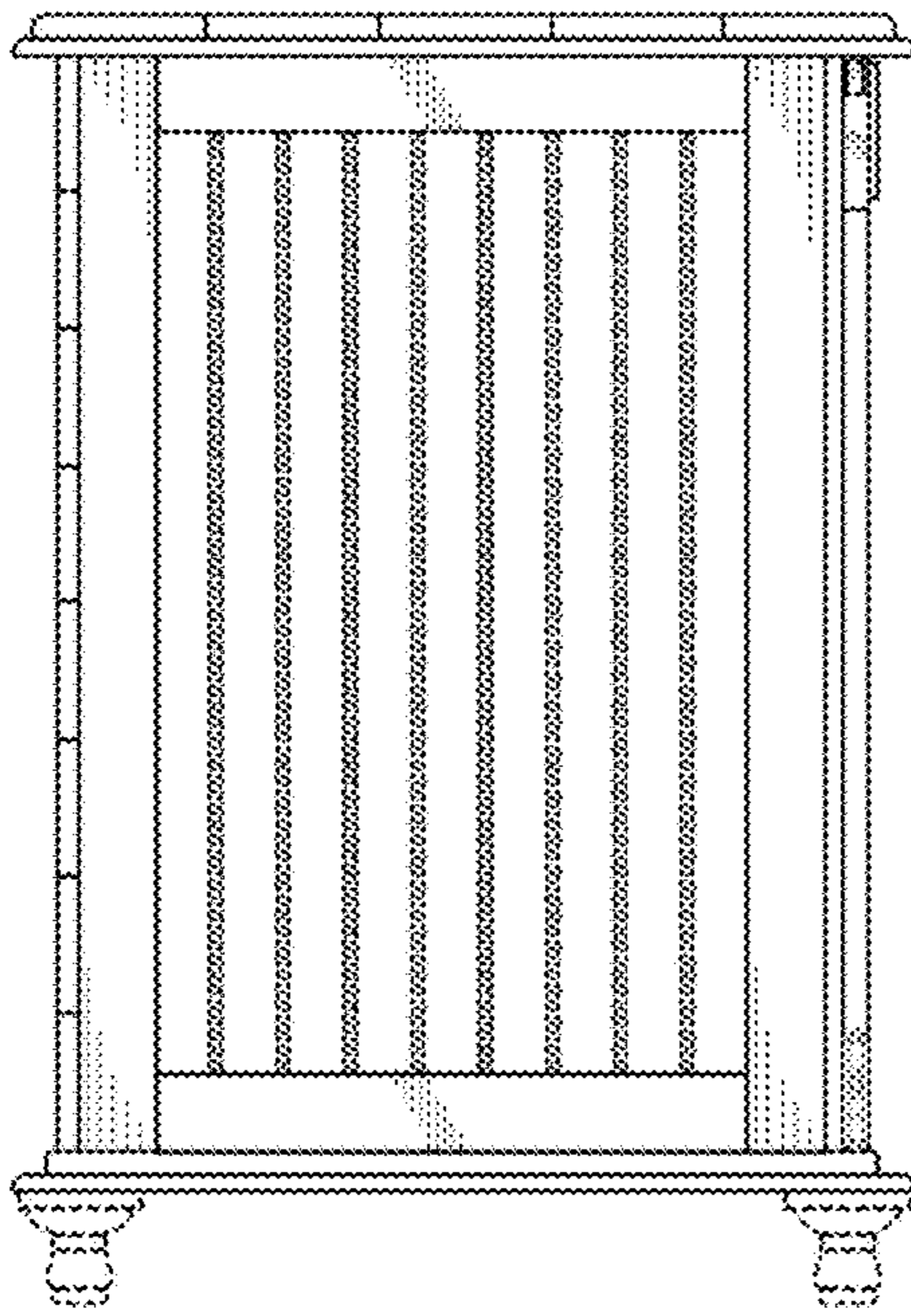

FIG. 14

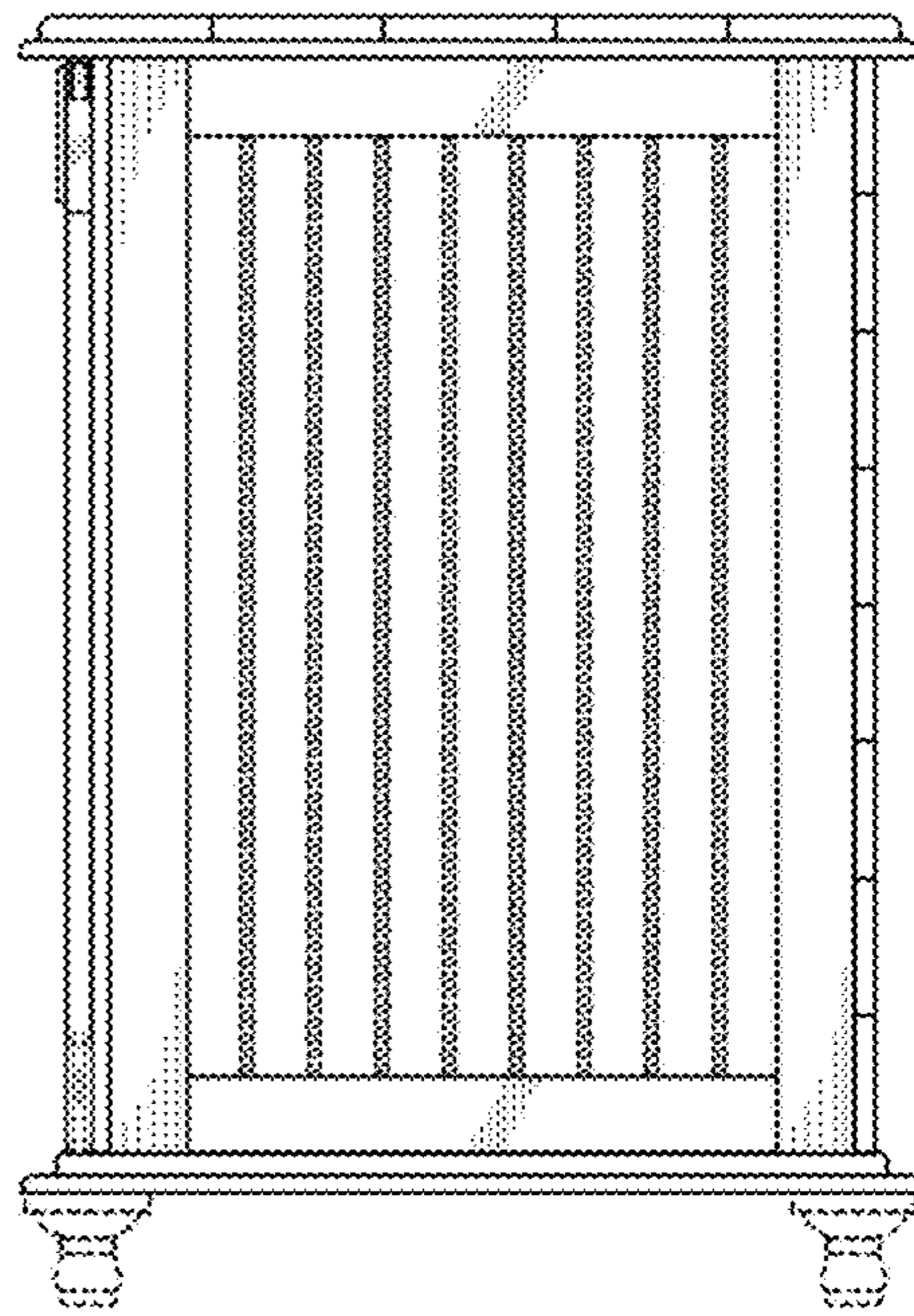

FIG. 15

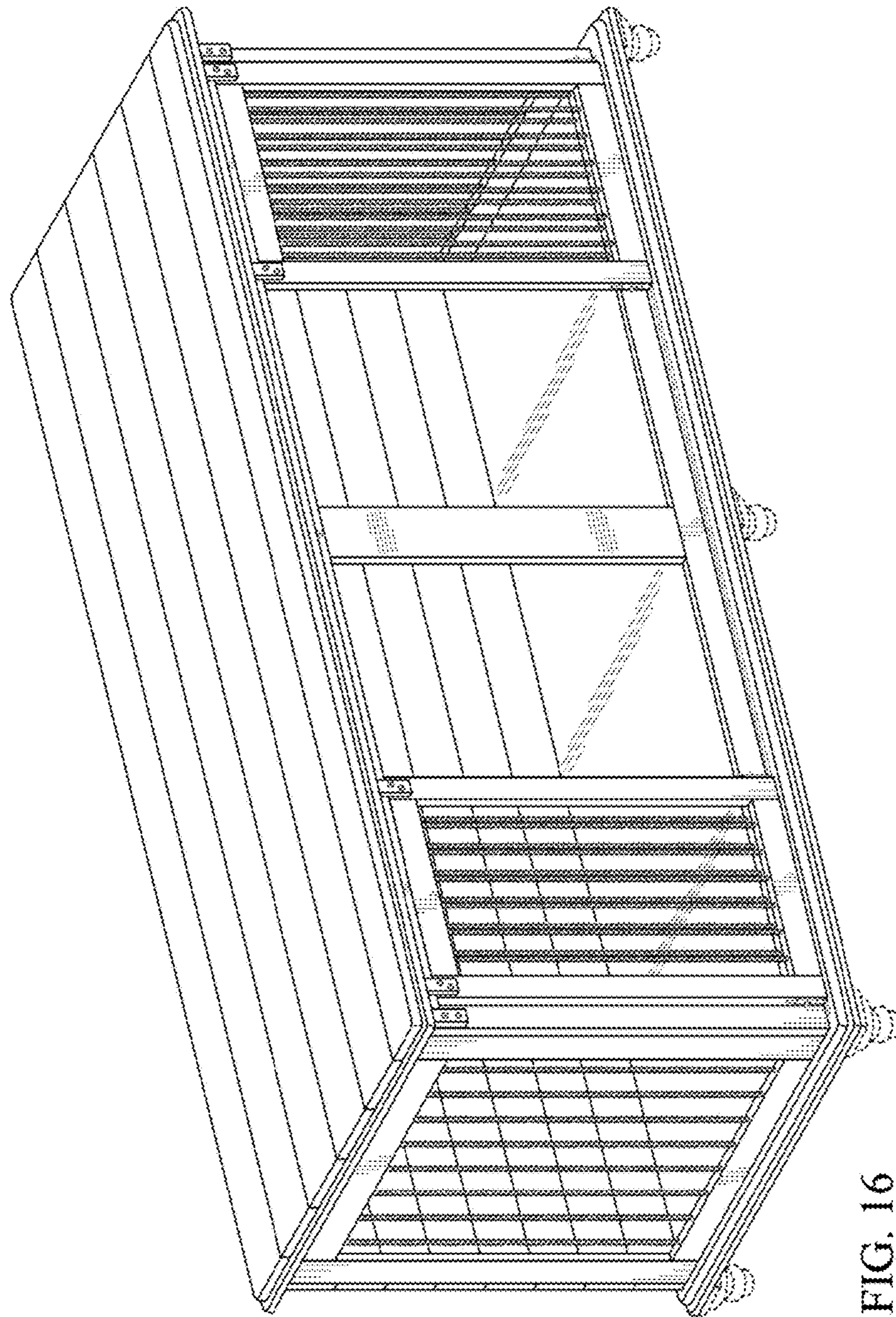

FIG. 16