



US00D855249S

(12) **United States Design Patent** (10) **Patent No.:** **US D855,249 S**  
**Qiu** (45) **Date of Patent:** **\*\* \*Jul. 30, 2019**

(54) **ELECTRONIC CIGARETTE**  
(71) Applicant: **Changzhou Patent Electronic Technology Co., LTD.**, Changzhou, Jiangsu (CN)  
(72) Inventor: **Weihua Qiu**, Jiangsu (CN)  
(73) Assignee: **Joyetech Europe Holding GmbH**, Zug (CH)  
(\* ) Notice: This patent is subject to a terminal disclaimer.  
(\*\* ) Term: **15 Years**  
(21) Appl. No.: **29/627,936**  
(22) Filed: **Nov. 30, 2017**  
(30) **Foreign Application Priority Data**  
Jun. 15, 2017 (CN) ..... 2017 3 0244787  
(51) **LOC (11) Cl.** ..... **27-07**  
(52) **U.S. Cl.**  
USPC ..... **D27/162**  
(58) **Field of Classification Search**  
USPC ..... D27/100, 101, 162, 163–194;  
D19/115–123, 161–169; D24/110;  
D23/366  
CPC ..... A24F 47/008; A24F 47/002; A24F 7/02;  
A61M 15/06  
See application file for complete search history.

(56) **References Cited**  
**U.S. PATENT DOCUMENTS**  
D368,552 S \* 4/1996 Adams ..... D27/194  
D422,113 S \* 3/2000 Higgins ..... D27/186  
D424,236 S \* 5/2000 Reed ..... D27/163  
D433,532 S \* 11/2000 Higgins ..... D27/186  
D547,859 S \* 7/2007 Choi ..... D24/113  
D577,150 S \* 9/2008 Bryman ..... D27/163

D579,544 S \* 10/2008 Birath ..... D24/110  
D579,545 S \* 10/2008 Birath ..... D24/110  
D579,547 S \* 10/2008 Birath ..... D24/110  
D629,154 S \* 12/2010 Sung ..... D27/154  
D649,708 S \* 11/2011 Oneil ..... D27/163  
D654,160 S \* 2/2012 Yomtov ..... D23/360

(Continued)

*Primary Examiner* — Marissa J Cash  
(74) *Attorney, Agent, or Firm* — Novick, Kim & Lee, PLLC; Allen Xue; Hyun Woo Shin

(57) **CLAIM**

I claim the ornamental design for an electronic cigarette, as shown and described.

**DESCRIPTION**

FIG. 1 is a top, front, left side perspective view of a first embodiment of an electronic cigarette, showing my new design;  
FIG. 2 is a bottom, front, right side perspective view thereof;  
FIG. 3 is a front elevational view thereof;  
FIG. 4 is a rear elevational view thereof;  
FIG. 5 is a left side elevational view thereof;  
FIG. 6 is a right side elevational view thereof;  
FIG. 7 is a top plan view thereof;  
FIG. 8 is a bottom plan view thereof;  
FIG. 9 is a top, front, left side perspective view of a second embodiment of the electronic cigarette;  
FIG. 10 is a bottom, front, right side perspective view thereof;  
FIG. 11 is a front elevational view thereof;  
FIG. 12 is a rear elevational view thereof;  
FIG. 13 is a left side elevational view thereof;  
FIG. 14 is a right side elevational view thereof;  
FIG. 15 is a top plan view thereof; and,  
FIG. 16 is a bottom plan view thereof.  
The broken lines in the drawings show portions of the electronic cigarette which form no part of the claimed design.

**1 Claim, 16 Drawing Sheets**

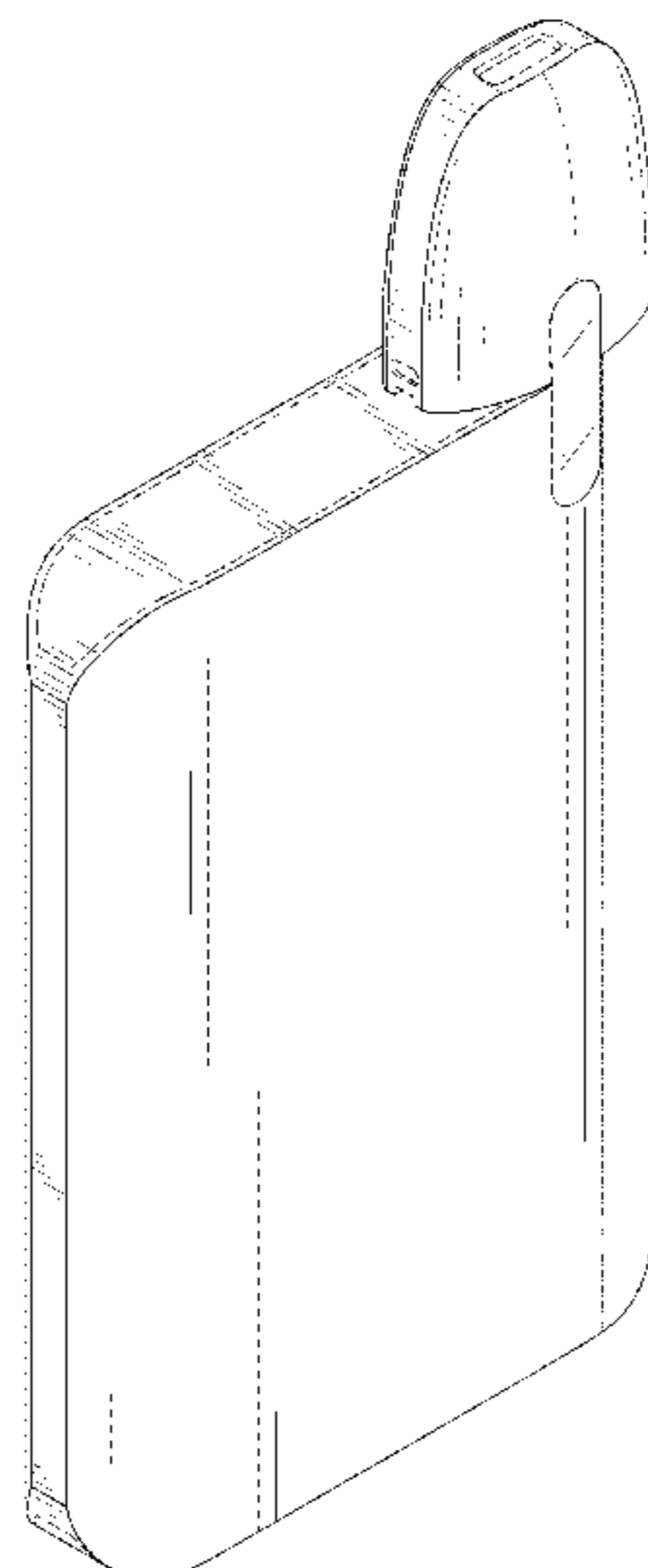

(56)

References Cited

U.S. PATENT DOCUMENTS

D728,855 S \* 5/2015 Liu ..... D27/163  
 D729,444 S \* 5/2015 Leidel ..... D27/163  
 D729,445 S \* 5/2015 Leidel ..... D27/163  
 D730,572 S \* 5/2015 Leidel ..... D27/163  
 D731,114 S \* 6/2015 Leidel ..... D27/163  
 D743,099 S \* 11/2015 Oglesby ..... D27/101  
 D748,325 S \* 1/2016 Leidel ..... D27/163  
 D753,336 S \* 4/2016 Chen ..... D27/101  
 9,301,545 B2 \* 4/2016 Li ..... A24F 15/18  
 D758,004 S \* 5/2016 Freshwater ..... D27/163  
 D758,655 S \* 6/2016 Freshwater ..... D27/163  
 D758,656 S \* 6/2016 Freshwater ..... D27/163  
 D761,999 S \* 7/2016 Liu ..... D27/101  
 D769,520 S \* 10/2016 Hua ..... D27/167  
 D770,678 S \* 11/2016 Shin ..... D27/163  
 D771,867 S \* 11/2016 Leidel ..... D27/163  
 D772,477 S \* 11/2016 Shin ..... D27/163  
 D773,114 S \* 11/2016 Leidel ..... D27/163  
 D773,116 S \* 11/2016 Liu ..... D27/167  
 D775,414 S \* 12/2016 Ampolini ..... D13/108  
 D775,762 S \* 1/2017 Chen ..... D27/101  
 D780,373 S \* 2/2017 Bennett ..... D27/186  
 D788,362 S \* 5/2017 Qiu ..... D27/101  
 D788,364 S \* 5/2017 Chen ..... D27/163  
 D790,766 S \* 6/2017 Li ..... D27/163  
 D792,020 S \* 7/2017 Mendoza ..... D27/101  
 D792,021 S \* 7/2017 Beer ..... D27/101  
 D799,111 S \* 10/2017 Qiu ..... D27/101  
 D799,743 S \* 10/2017 Qiu ..... D27/101  
 D799,746 S \* 10/2017 Leidel ..... D27/163  
 D800,377 S \* 10/2017 Liu ..... D27/101  
 D801,507 S \* 10/2017 Kelnhofer ..... D23/366  
 D802,834 S \* 11/2017 Mathias ..... D27/163  
 D805,685 S \* 12/2017 Lee ..... D27/101  
 D807,286 S \* 1/2018 Qiu ..... D13/103  
 D807,576 S \* 1/2018 Liu ..... D27/163  
 D807,577 S \* 1/2018 Ward ..... D27/167

D807,818 S \* 1/2018 Mathias ..... D13/107  
 D808,071 S \* 1/2018 Folkerts ..... D27/101  
 D808,073 S \* 1/2018 Leidel ..... D27/162  
 D808,792 S \* 1/2018 Jaggi ..... D9/420  
 D809,191 S \* 1/2018 Li ..... D27/101  
 D809,192 S \* 1/2018 Liu ..... D27/163  
 D814,693 S \* 4/2018 Qiu ..... D27/101  
 D815,347 S \* 4/2018 Jones ..... D27/194  
 9,961,940 B2 \* 5/2018 Anderson, Jr. .... A24F 47/008  
 9,968,136 B1 \* 5/2018 Bell ..... A24F 47/008  
 D819,880 S \* 6/2018 Qiu ..... D27/101  
 D819,882 S \* 6/2018 Qiu ..... D27/101  
 D821,639 S \* 6/2018 Dai ..... D27/162  
 D821,640 S \* 6/2018 Qiu ..... D27/162  
 D828,621 S \* 9/2018 Qiu ..... D27/162  
 D829,371 S \* 9/2018 Durand ..... D27/101  
 D829,980 S \* 10/2018 Qiu ..... D27/162  
 D829,983 S \* 10/2018 Wang ..... D27/167  
 D832,499 S \* 10/2018 Qiu ..... D27/162  
 D832,500 S \* 10/2018 Qiu ..... D27/162  
 2017/0006918 A1 \* 1/2017 Chen ..... A24F 47/008  
 2017/0208863 A1 \* 7/2017 Davis ..... A24F 47/008  
 2017/0208864 A1 \* 7/2017 Anderson, Jr. .... A24F 47/008  
 2017/0245550 A1 \* 8/2017 Freelander ..... A24F 47/008  
 2017/0290371 A1 \* 10/2017 Davis ..... A24F 47/008  
 2017/0367406 A1 \* 12/2017 Schuler ..... A24F 47/008  
 2018/0007967 A1 \* 1/2018 Davis ..... A24F 47/008  
 2018/0013175 A1 \* 1/2018 Liu ..... H01M 10/425  
 2018/0035715 A1 \* 2/2018 Wu ..... A24F 47/008  
 2018/0070638 A1 \* 3/2018 Qiu ..... A24F 47/008  
 2018/0084828 A1 \* 3/2018 Phillips ..... A24F 47/008  
 2018/0084836 A1 \* 3/2018 Perez ..... B65D 85/54  
 2018/0110943 A1 \* 4/2018 Raichman ..... A61M 15/06  
 2018/0116281 A1 \* 5/2018 Anderson, Jr. .... A24F 47/008  
 2018/0132526 A1 \* 5/2018 Davis ..... A24F 47/008  
 2018/0153219 A1 \* 6/2018 Verleur ..... A24F 47/008  
 2018/0160739 A1 \* 6/2018 Chen ..... A24F 47/008  
 2018/0166238 A1 \* 6/2018 Chen ..... H01H 36/02

\* cited by examiner

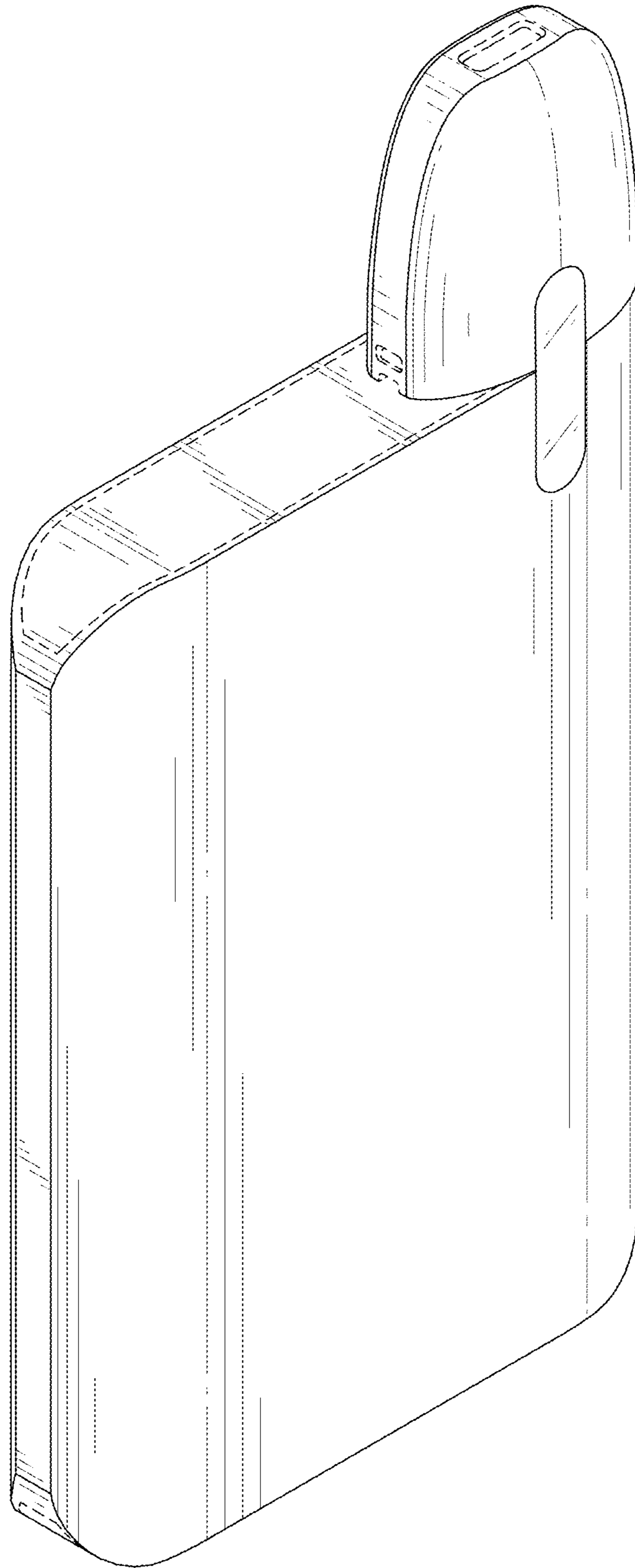

FIG. 1

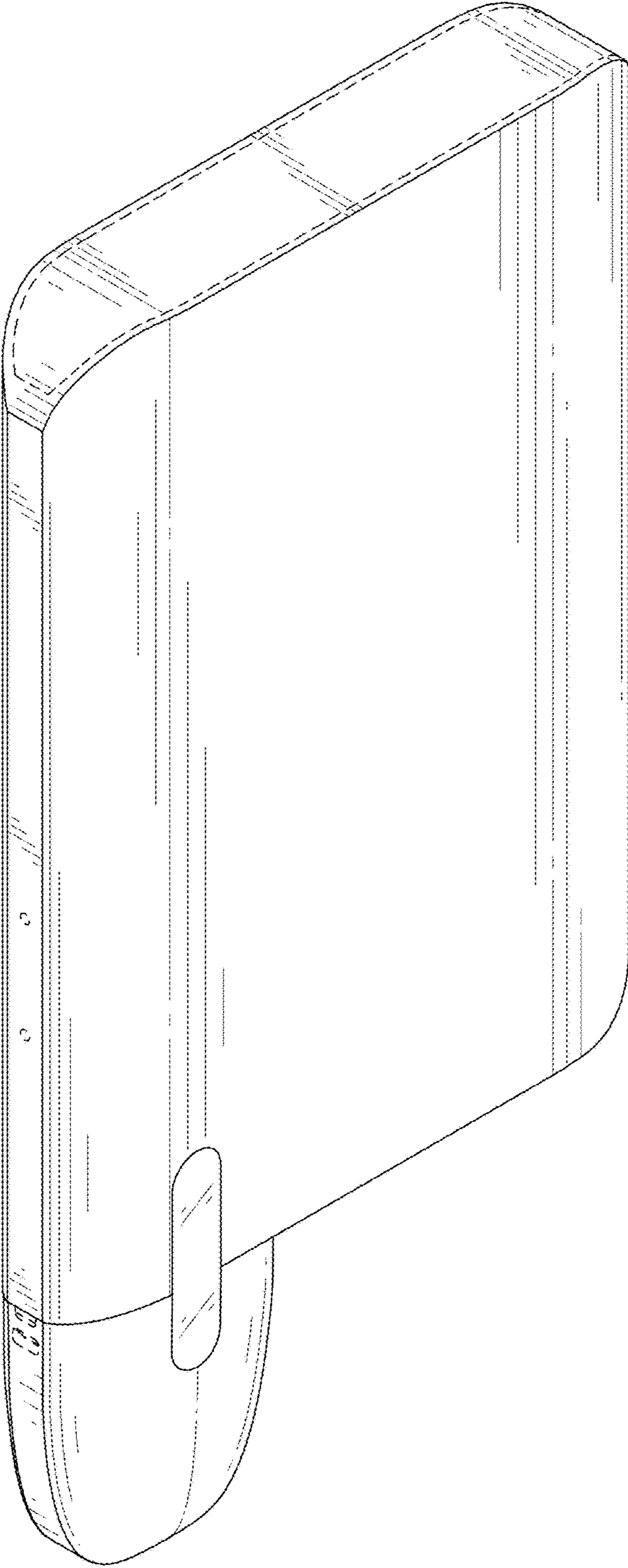

FIG. 2

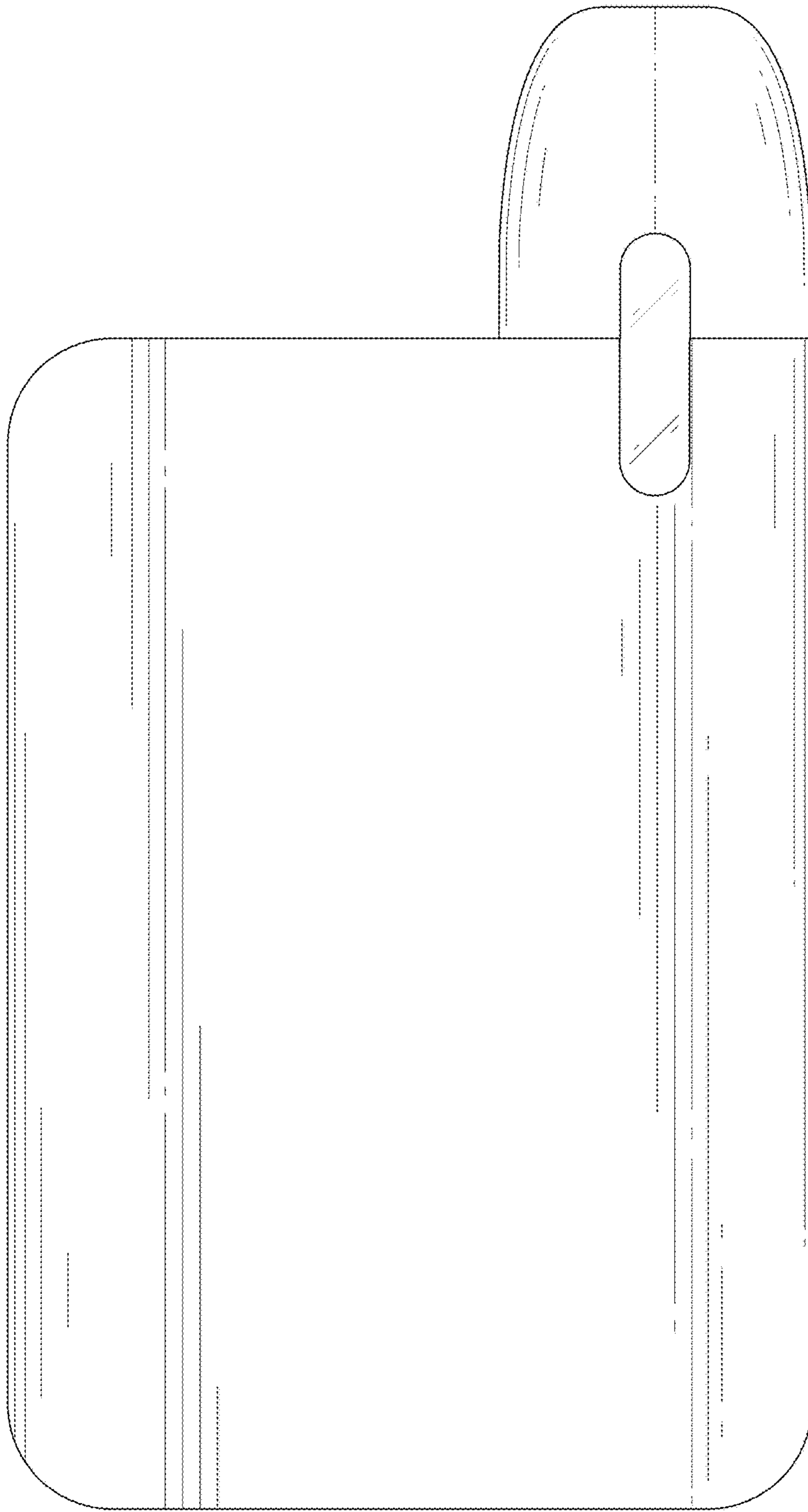

FIG. 3

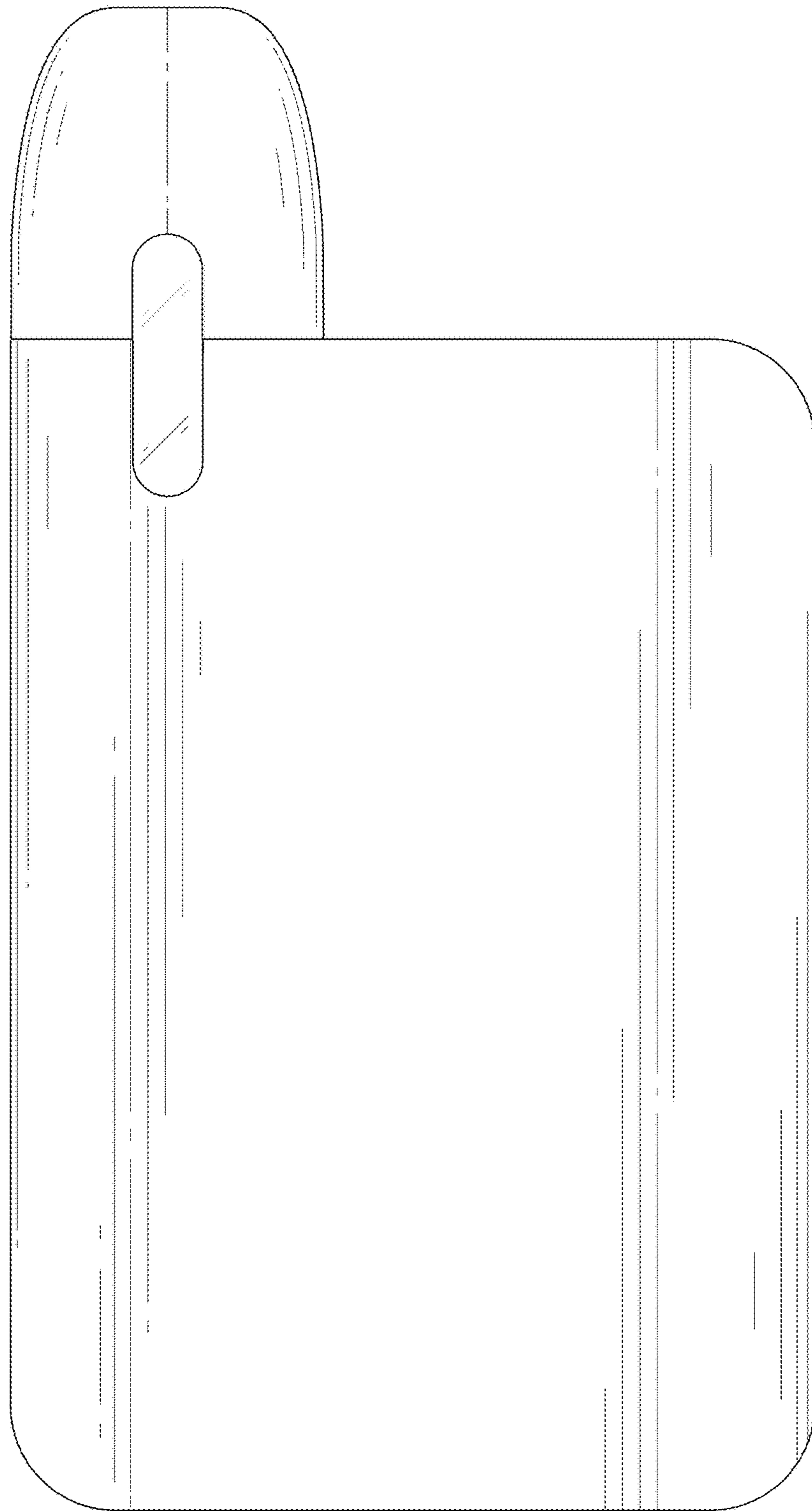

FIG. 4

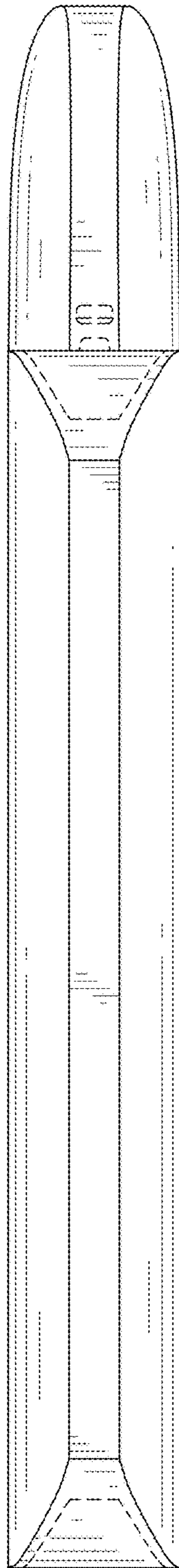

FIG. 5

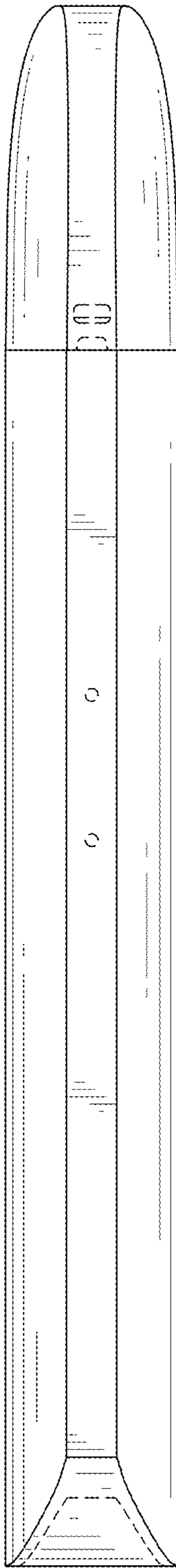

FIG. 6



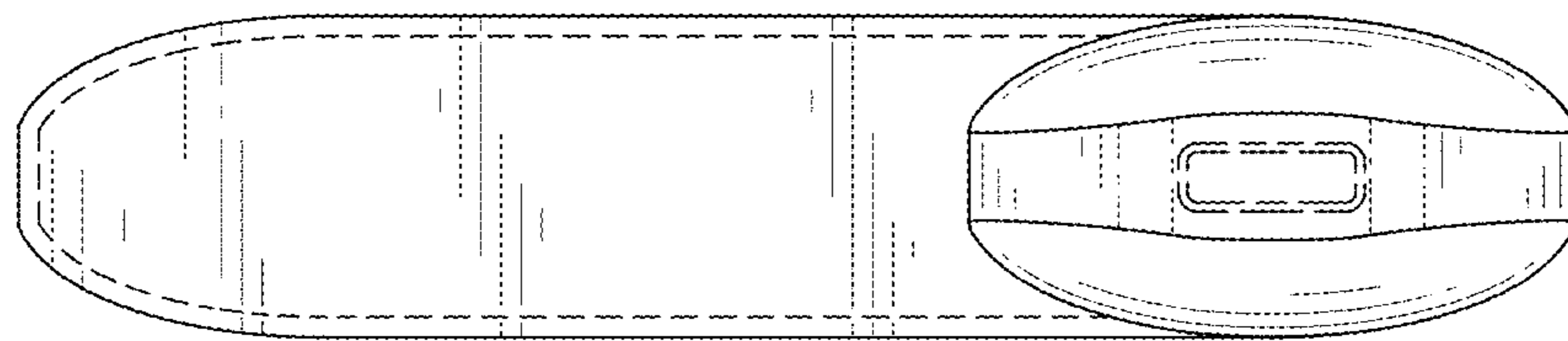

FIG. 7

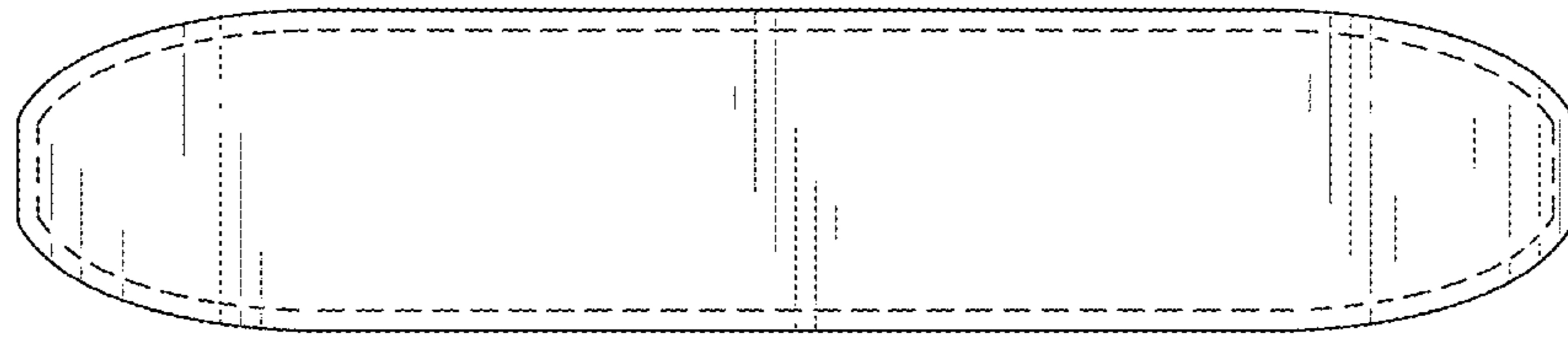

FIG. 8

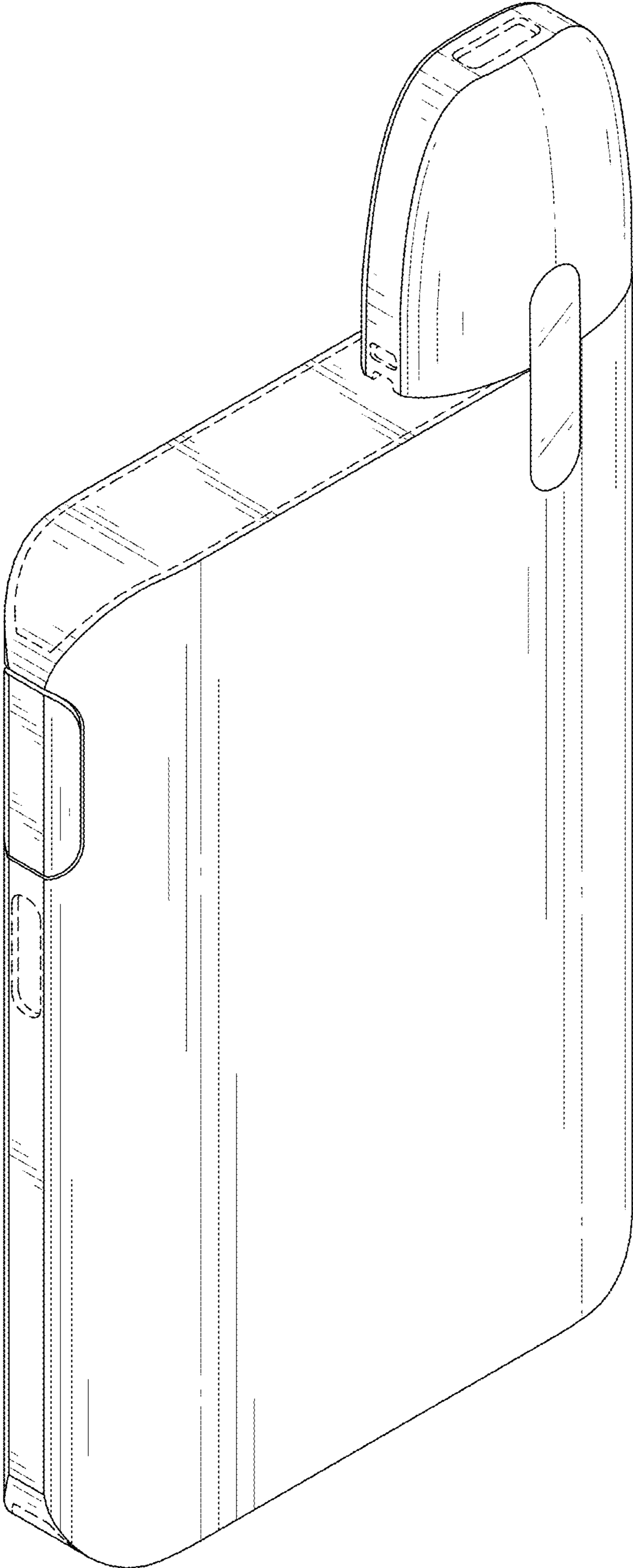

FIG. 9

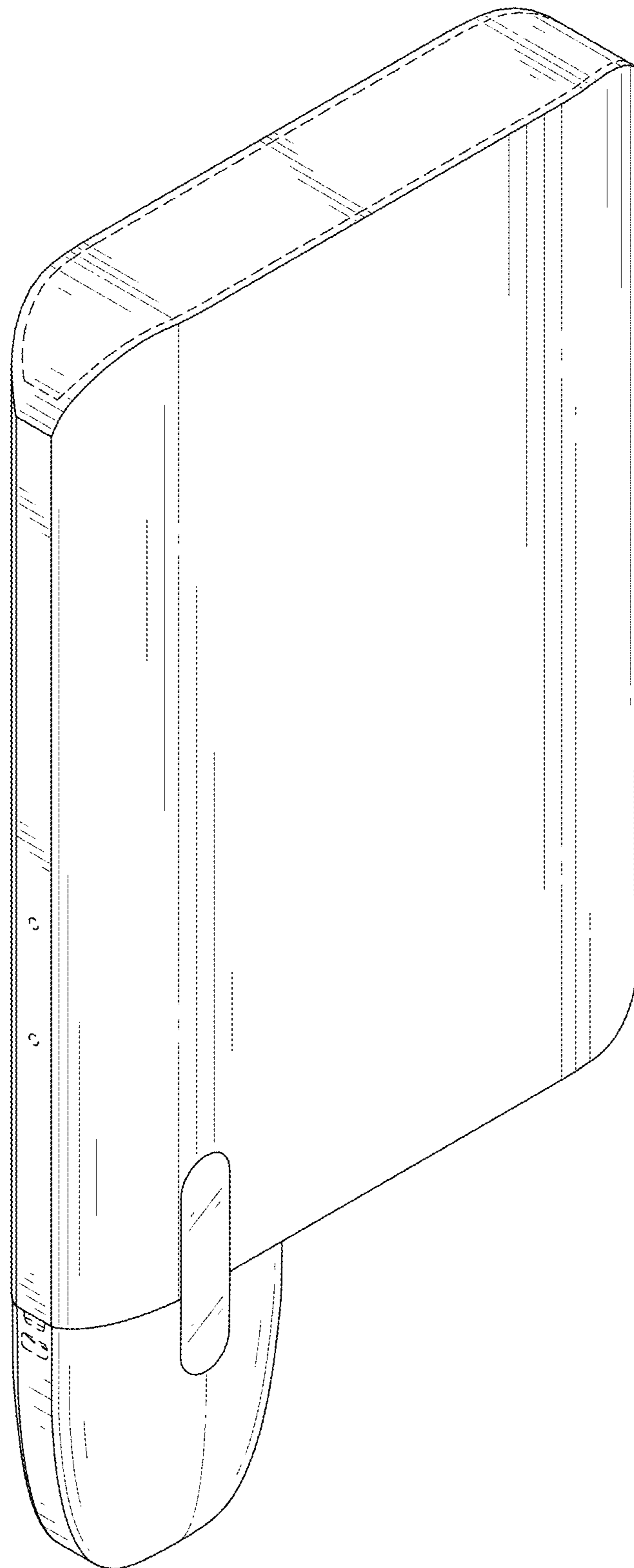

FIG. 10

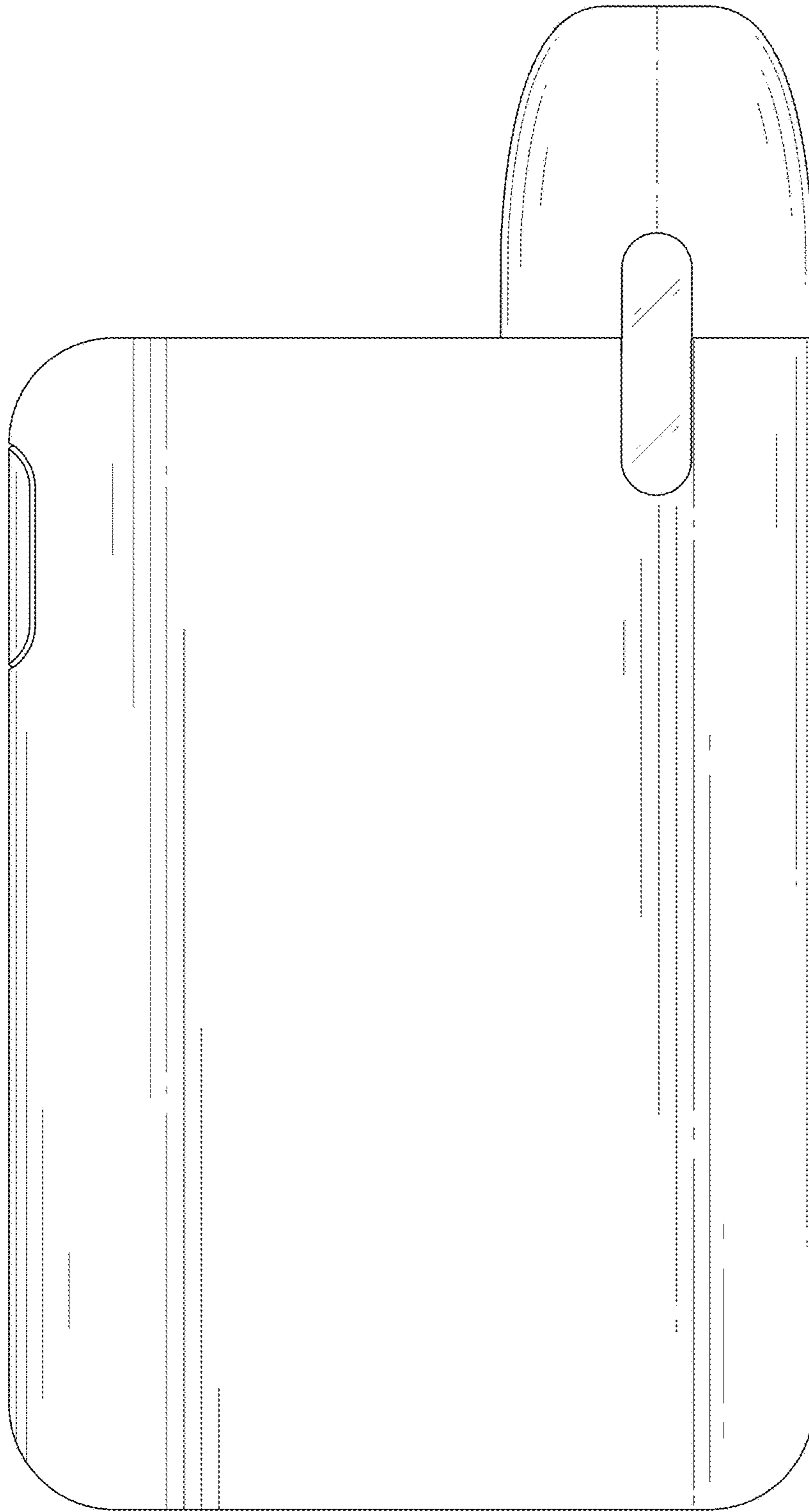

FIG. 11

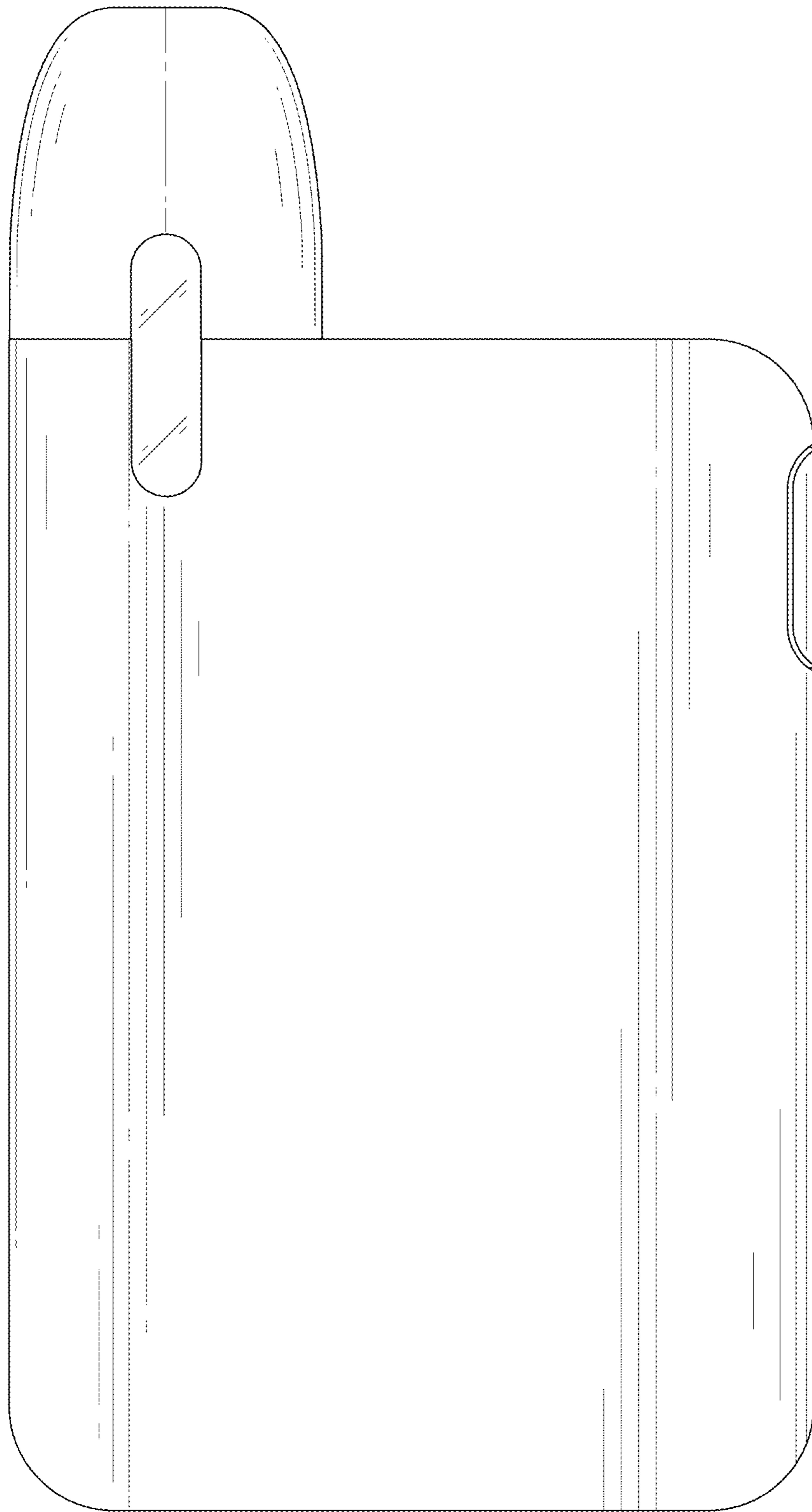

FIG. 12

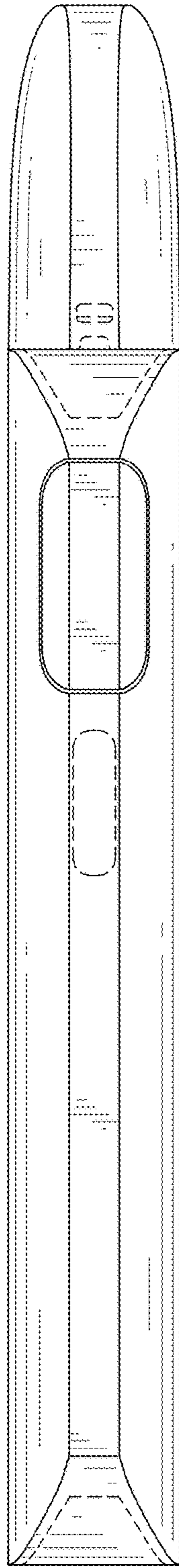

FIG. 13

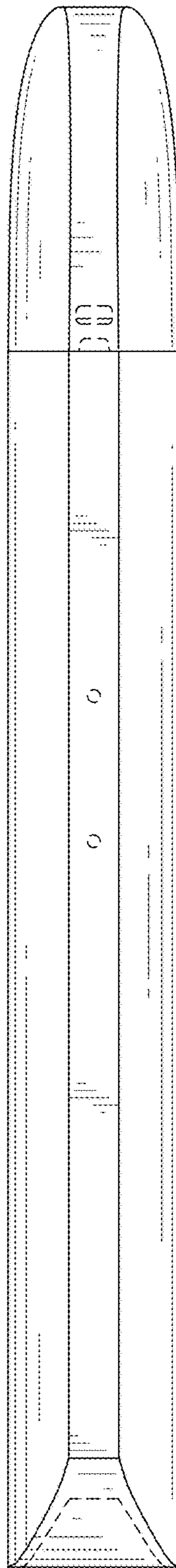

FIG. 14



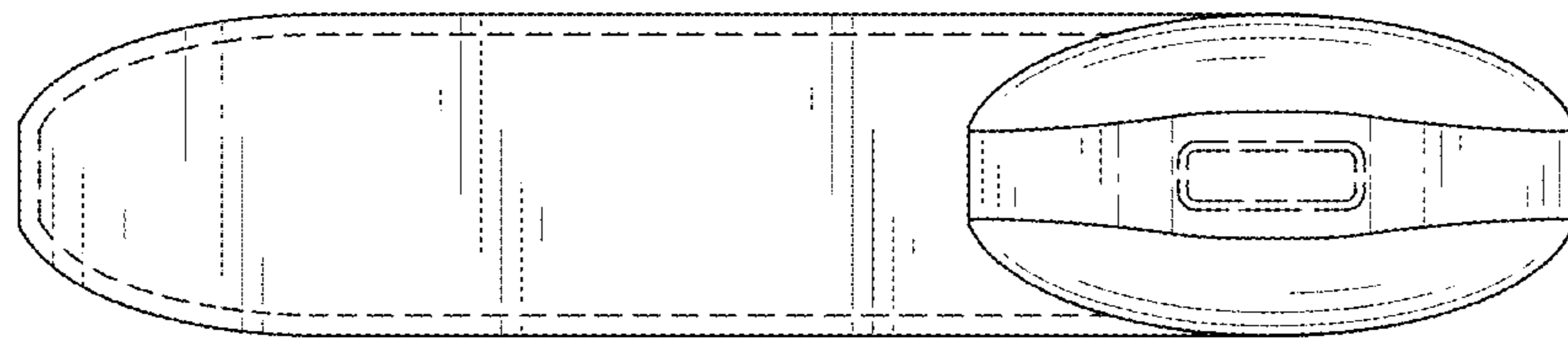

FIG. 15

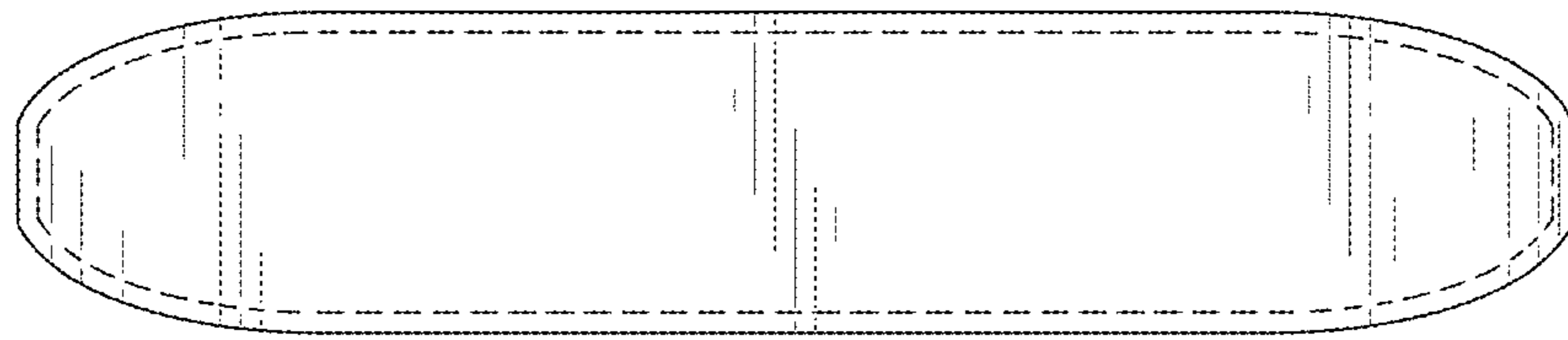

FIG. 16