



US00D855244S

(12) **United States Design Patent** (10) **Patent No.:** **US D855,244 S**
Sonneman (45) **Date of Patent:** **** Jul. 30, 2019**

(54) **CONNECTOR** D518,406 S * 4/2006 Stern D11/86
D569,344 S * 5/2008 Kawasaki D13/134
(71) Applicant: **Contemporary Visions, LLC,** D634,058 S * 3/2011 Peifer D26/113
Larchmont, NY (US) D704,578 S * 5/2014 Chen D10/70
D795,360 S * 8/2017 Ahn D21/499

(72) Inventor: **Robert A. Sonneman,** Mamaroneck, NY (US) * cited by examiner

(73) Assignee: **Contemporary Visions, LLC,** Larchmont, NY (US) *Primary Examiner — Zenia I Bennett*
(74) *Attorney, Agent, or Firm —* Gottlieb, Rackman & Reisman, P.C.

(**) Term: **15 Years**

(21) Appl. No.: **29/674,521**

(57) **CLAIM**

(22) Filed: **Dec. 21, 2018**

The ornamental design for a connector, as shown and described.

(51) **LOC (11) Cl.** **26-99**

(52) **U.S. Cl.**
USPC **D26/113**

DESCRIPTION

(58) **Field of Classification Search**
USPC D26/113; D22/142; D21/499, 500;
D11/86
CPC F21S 8/03; F21S 8/033; F21S 8/04; F21S
8/043; F21V 3/04; F21V 3/0418; F21V
3/0427; F21V 3/0436; F21V 3/0445;
F21V 21/02; F21V 21/03; F21V 29/506;
B01J 23/8875

FIG. 1 is a first perspective view of a connector showing our new design;
FIG. 2 is a second perspective view thereof;
FIG. 3 is a first side elevational view thereof;
FIG. 4 is a second side elevational view thereof;
FIG. 5 is a third side elevational view thereof;
FIG. 6 is a fourth side elevational view thereof;
FIG. 7 is a top plan view thereof; and,
FIG. 8 is a bottom plan view thereof.

See application file for complete search history.

The broken lines shown in the drawings are included for the purpose of illustrating elements of the connector for lighting system and form no part of the claimed design.

(56) **References Cited**

U.S. PATENT DOCUMENTS

D414,530 S * 9/1999 Rudy D21/500
D423,607 S * 4/2000 Rudy D21/500

1 Claim, 5 Drawing Sheets

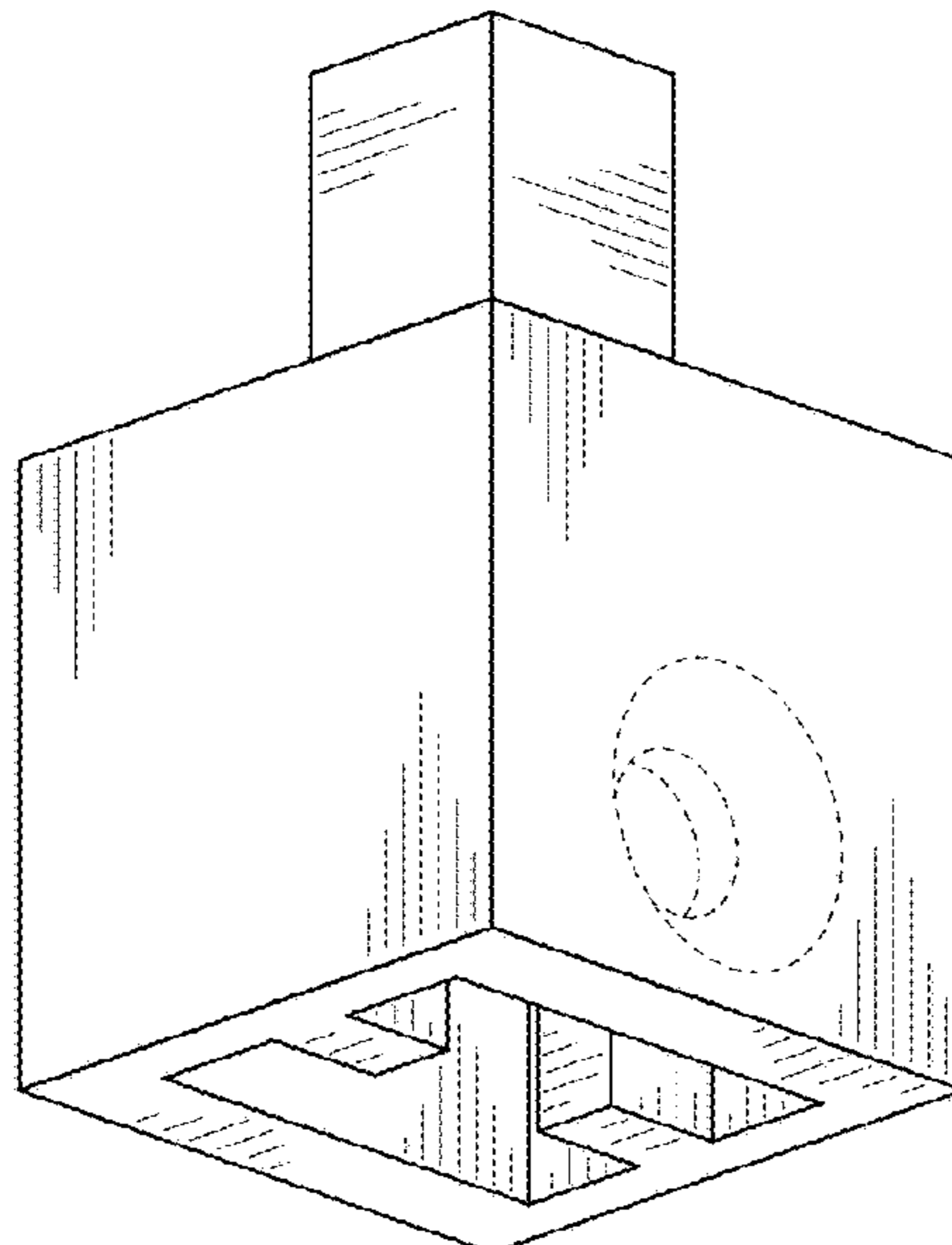

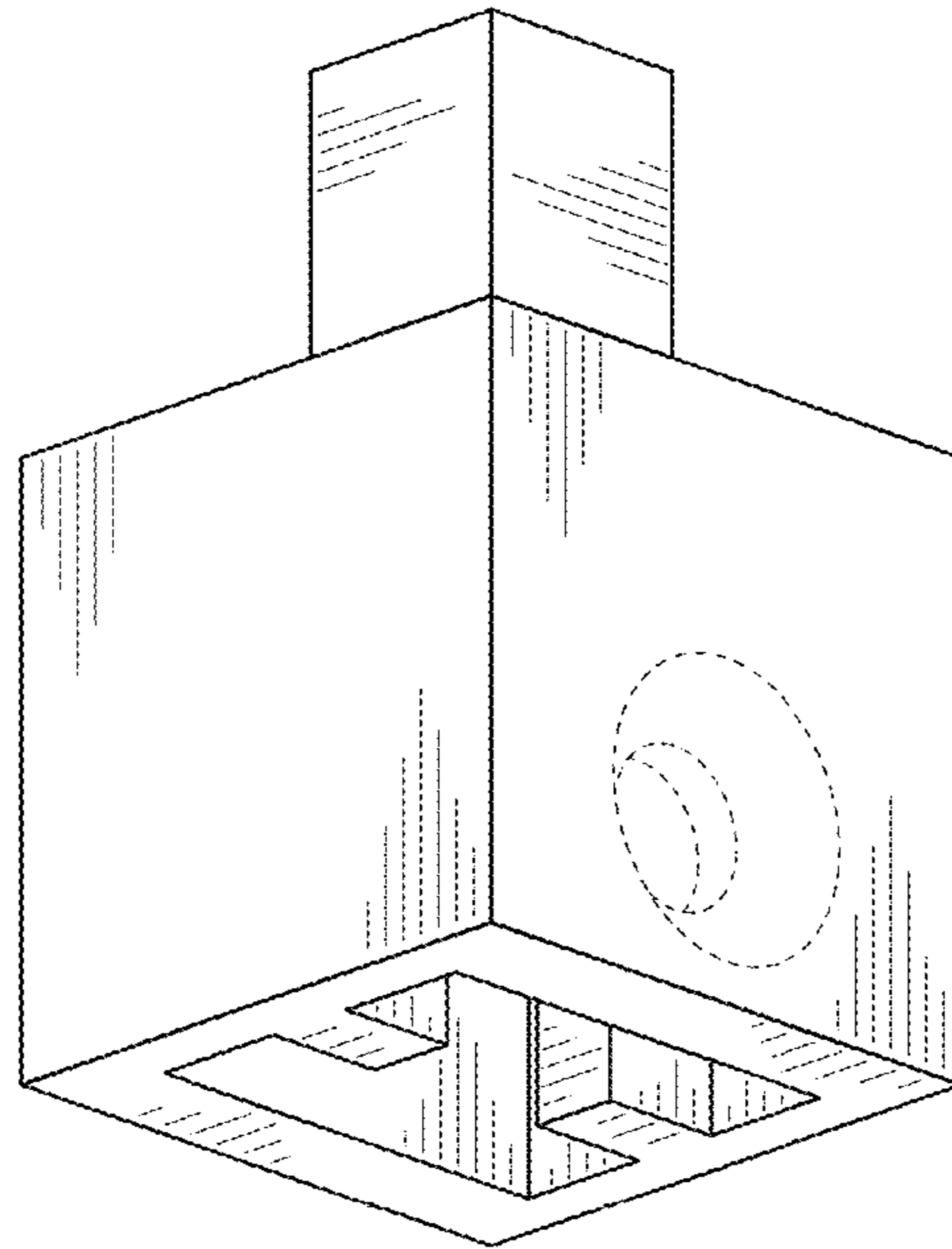

FIG. 1

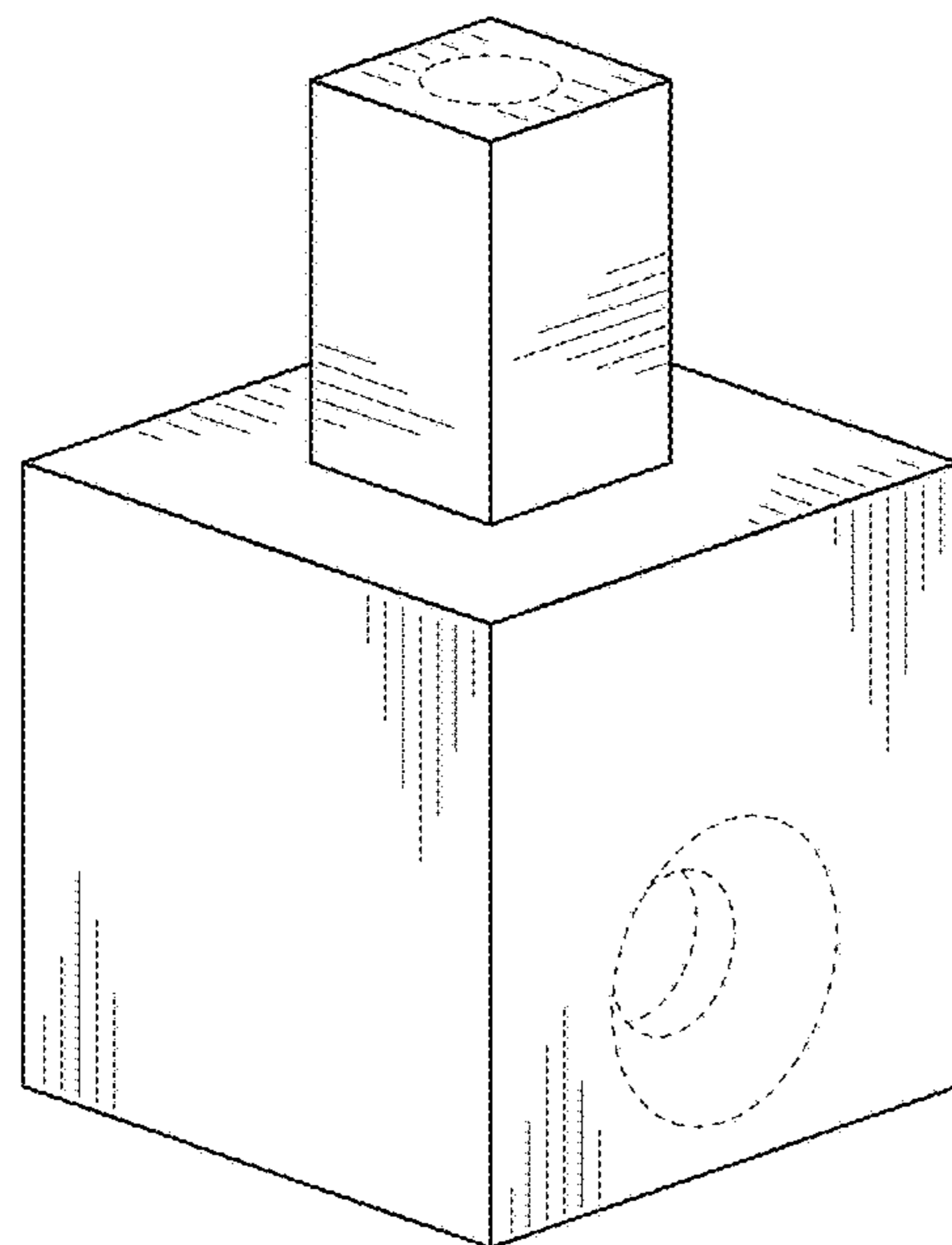

FIG. 2

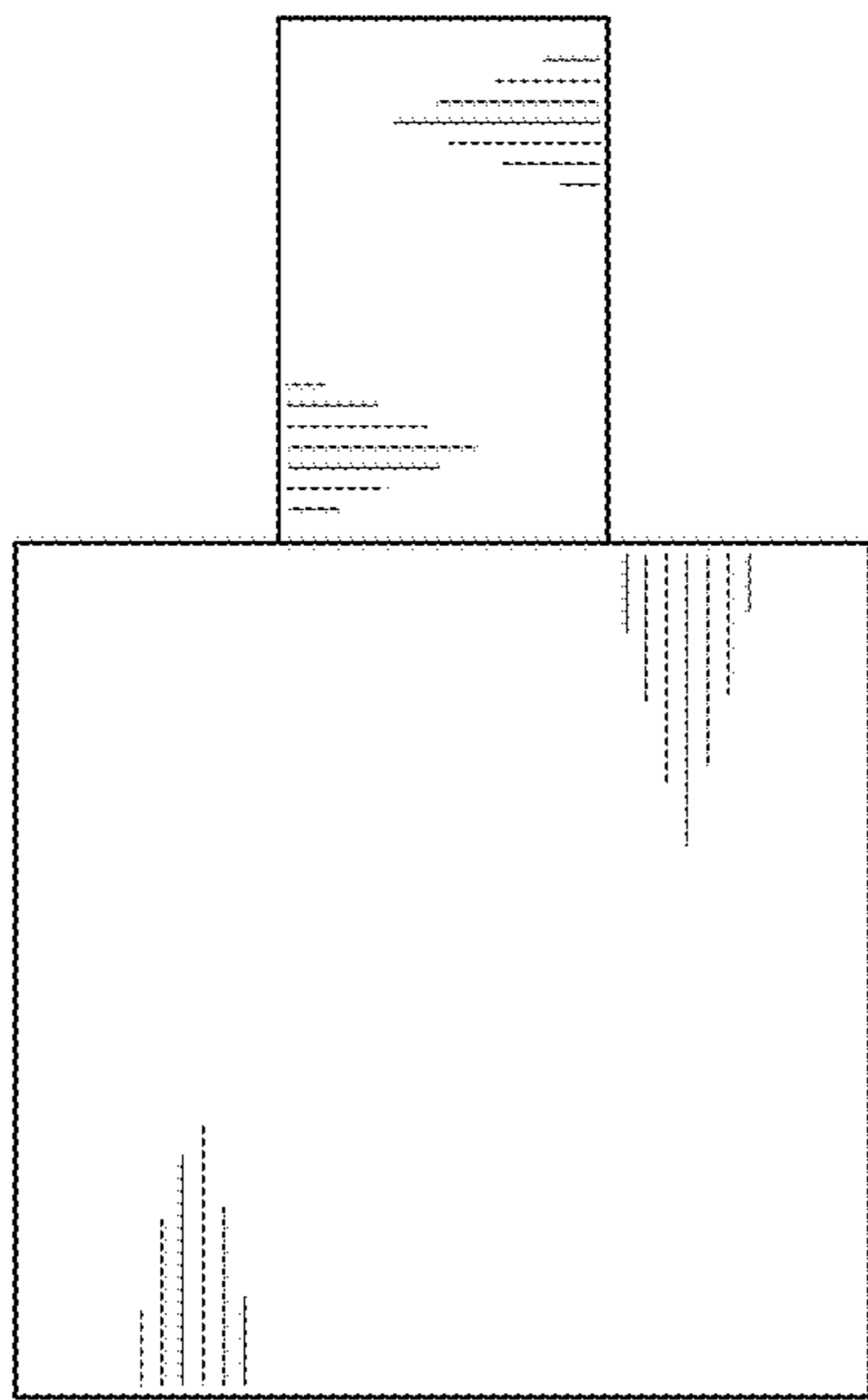

FIG. 3

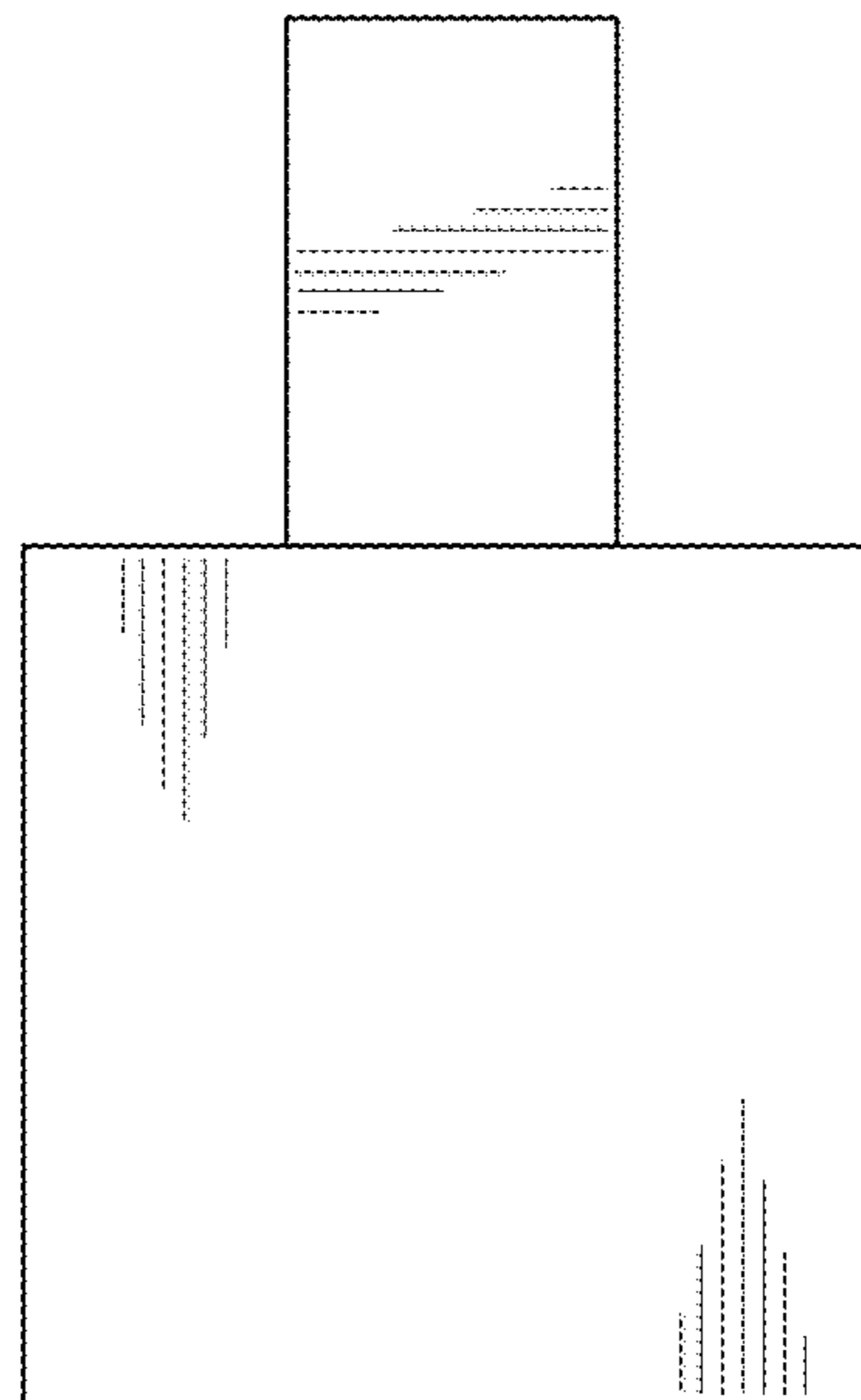

FIG. 4

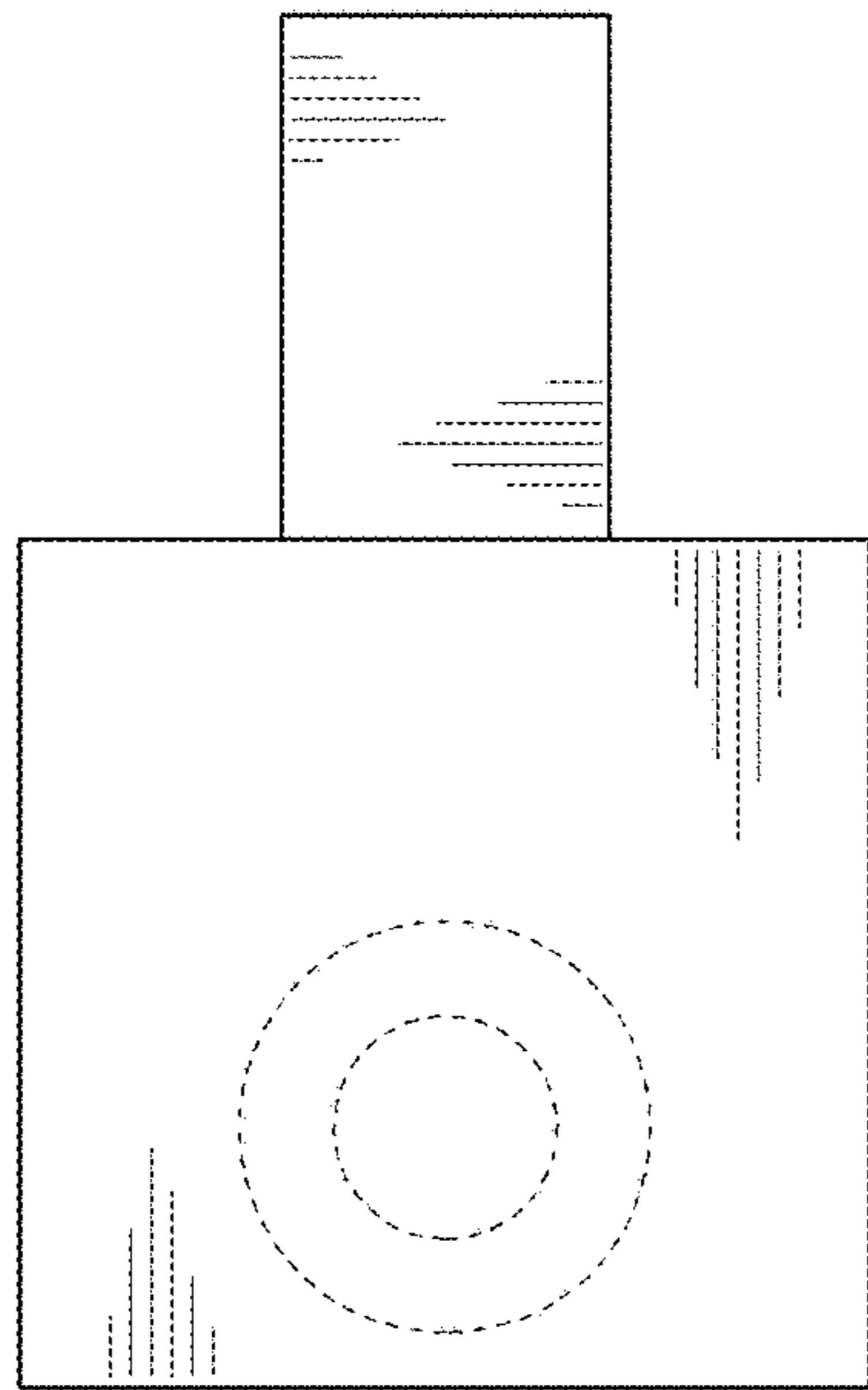

FIG. 5

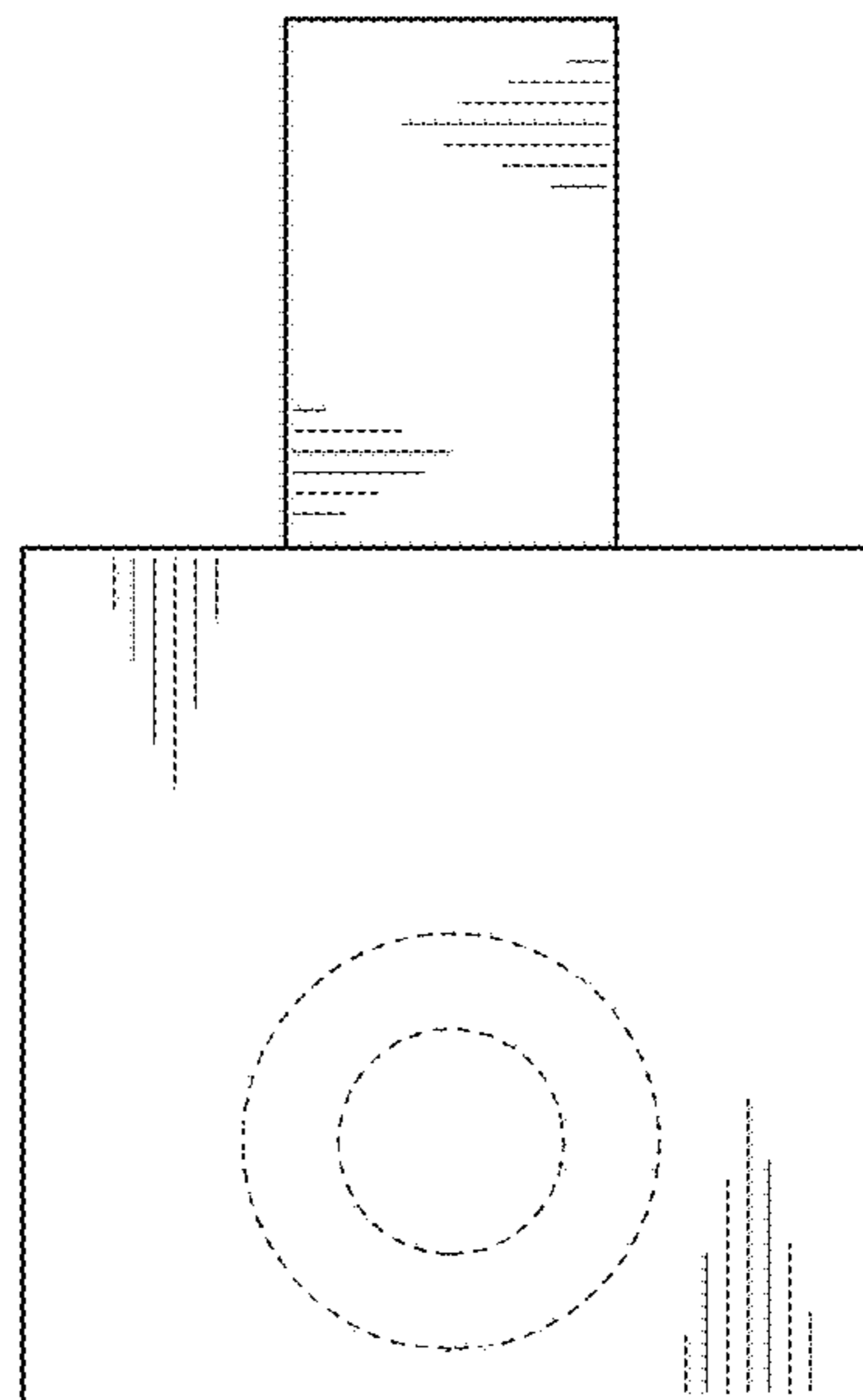

FIG. 6

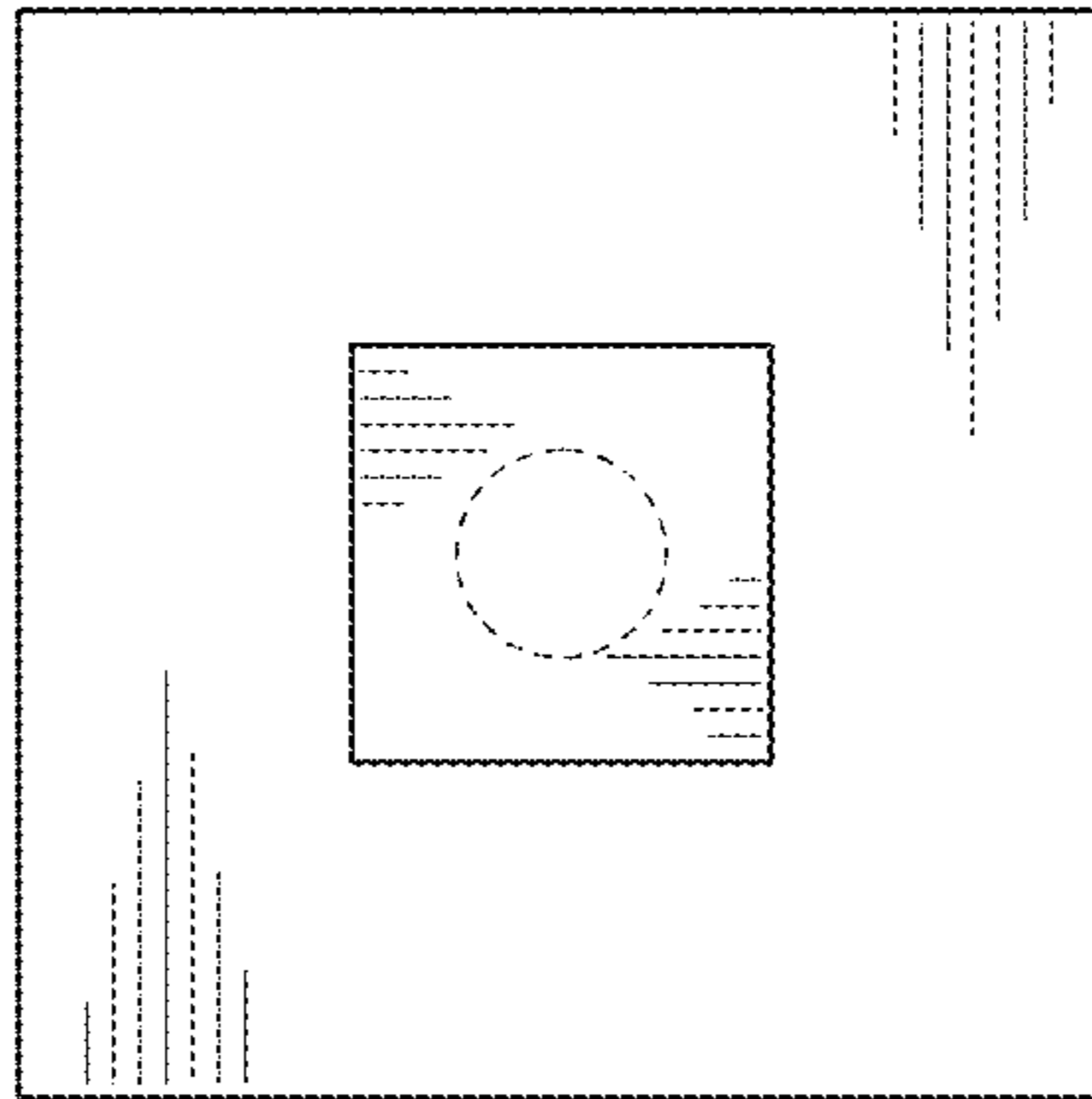

FIG. 7

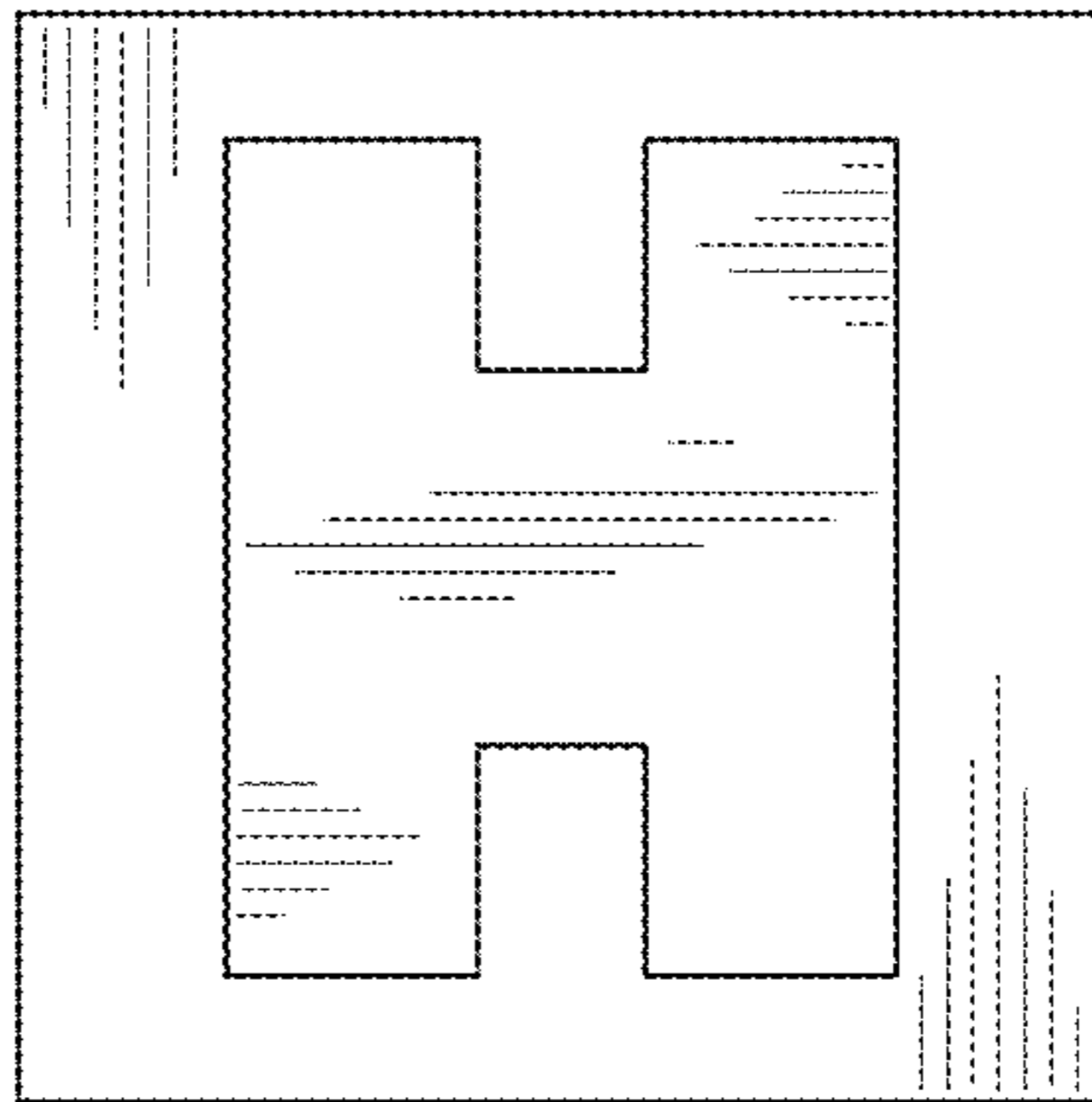

FIG. 8