



US00D855218S

(12) **United States Design Patent**
Santiago

(10) **Patent No.:** **US D855,218 S**
(45) **Date of Patent:** **** Jul. 30, 2019**

(54) **BRICK**
(71) Applicant: **Zenon Santiago**, Tigre (AR)
(72) Inventor: **Zenon Santiago**, Tigre (AR)
(**) Term: **15 Years**

3,148,477 A * 9/1964 Bjphirn A63H 33/082
446/106
D581,549 S * 11/2008 Thorkelson D25/113
D600,821 S * 9/2009 Esterhuizen E04B 2/18
D25/113
D686,756 S * 7/2013 Nanayakkara D25/113
D763,365 S * 8/2016 Ting D21/501
D763,366 S * 8/2016 Ting D21/501

(21) Appl. No.: **29/635,060**

* cited by examiner

(22) Filed: **Jan. 26, 2018**

Primary Examiner — Leanne Was-Englehart

(30) **Foreign Application Priority Data**

(74) *Attorney, Agent, or Firm* — Birch, Stewart, Kolasch & Birch, LLP

Jul. 27, 2017 (AR) 92090

(51) **LOC (11) Cl.** **25-01**

(57) **CLAIM**

The ornamental design for a brick, as shown and described.

(52) **U.S. Cl.**

DESCRIPTION

USPC **D25/114**

(58) **Field of Classification Search**

USPC D21/484–491, 499–502; D25/112–118

CPC A63H 33/082; E04B 2/18; E04B 2/28;

E04B 2/30; E04B 2002/0206

See application file for complete search history.

FIG. 1 is a front, left perspective view of the brick showing my new design;

FIG. 2 is a front, right perspective view thereof;

FIG. 3 is a left side view thereof, the right side view being a mirror image thereof;

FIG. 4 is a front view thereof, the rear view being a mirror image thereof;

FIG. 5 is a top plan view thereof; and,

FIG. 6 is a bottom plan view thereof.

The broken lines shown in FIGS. 1, 2, 5 and 6 depict unclaimed portions of the brick that form no part of the claimed design.

(56) **References Cited**

U.S. PATENT DOCUMENTS

2,610,503 A * 9/1952 Hall E04B 2/42

52/284

2,703,487 A * 3/1955 Ossoinack E04B 2/30

52/592.3

1 Claim, 6 Drawing Sheets

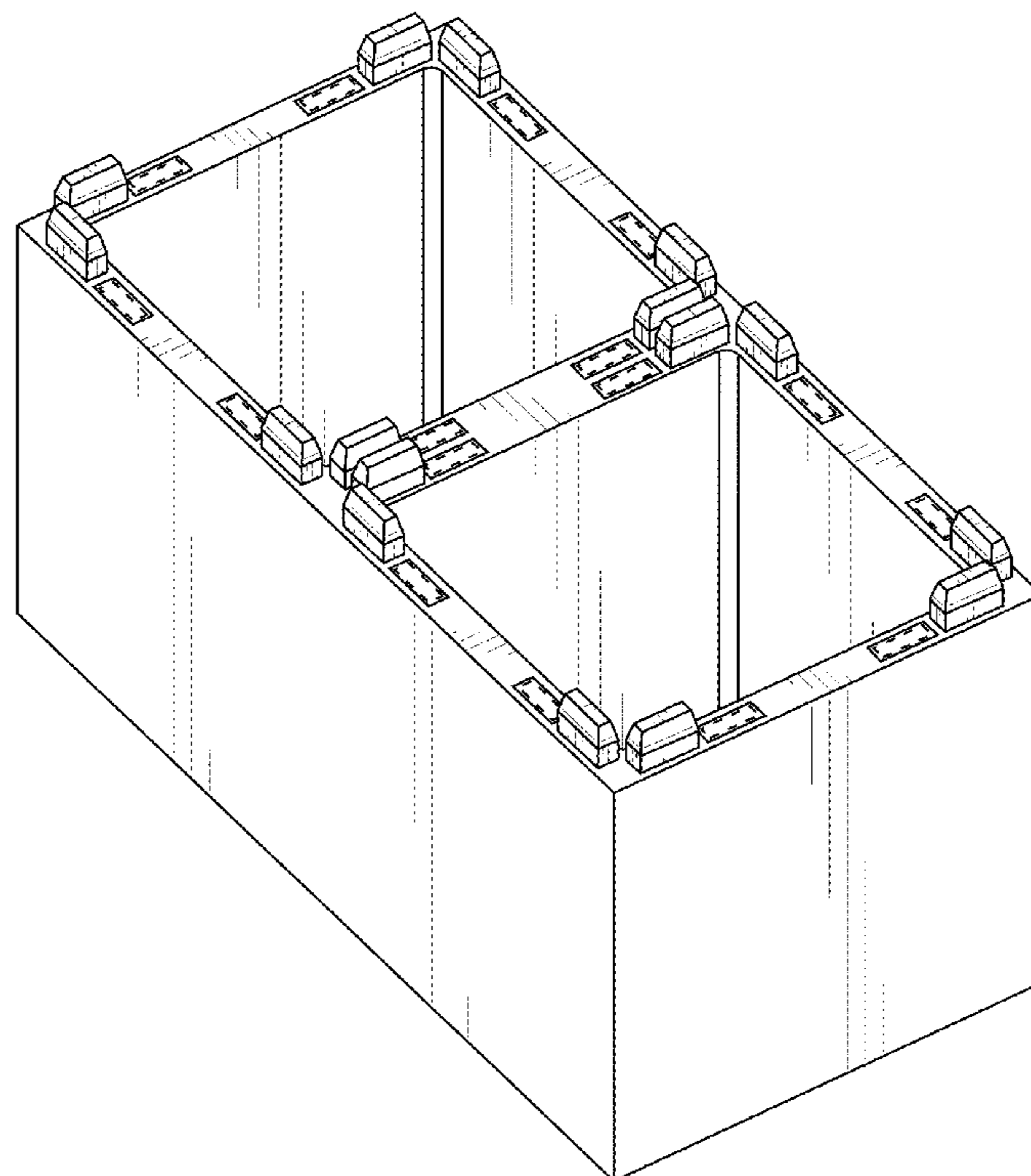

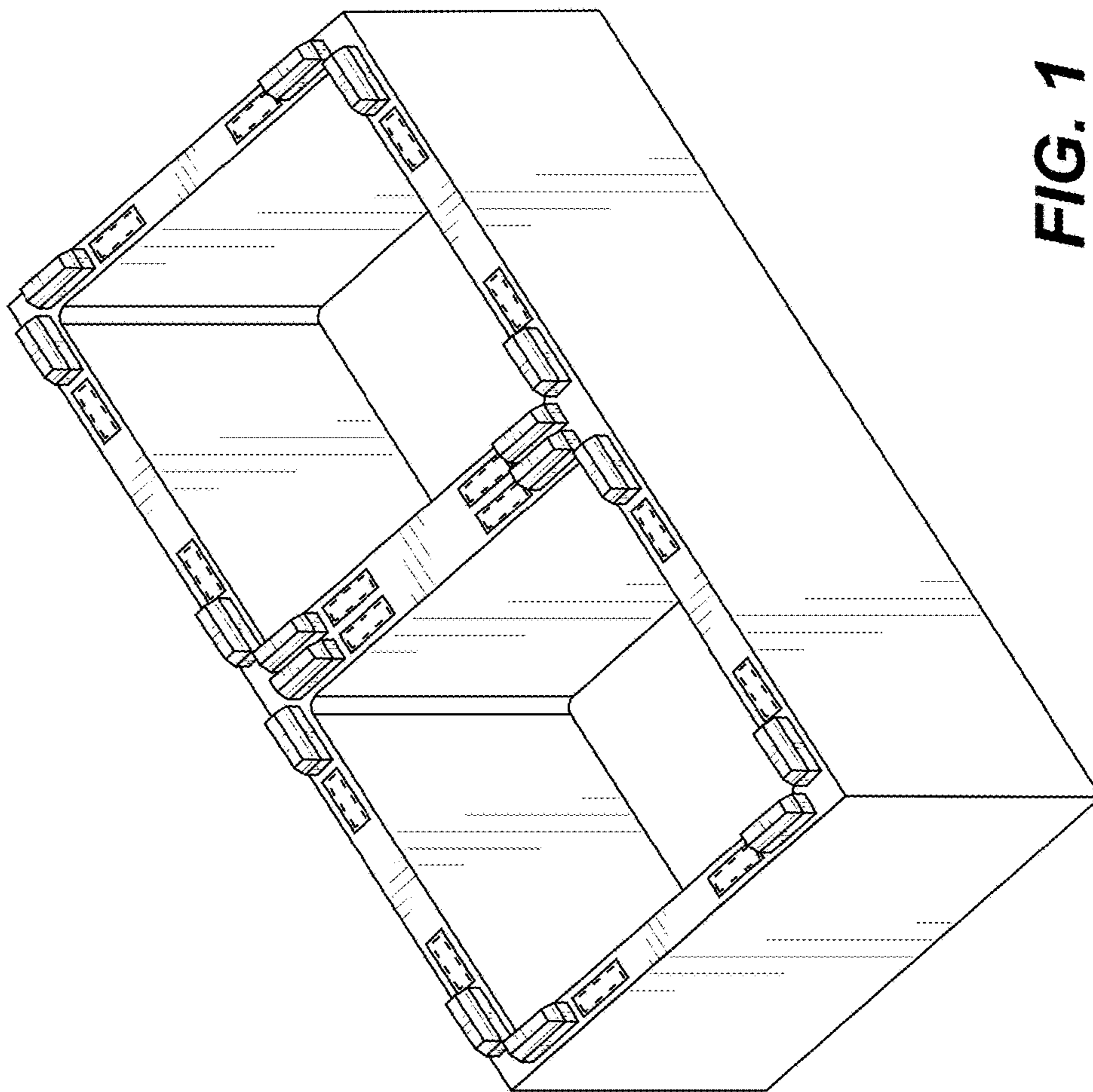

FIG. 1

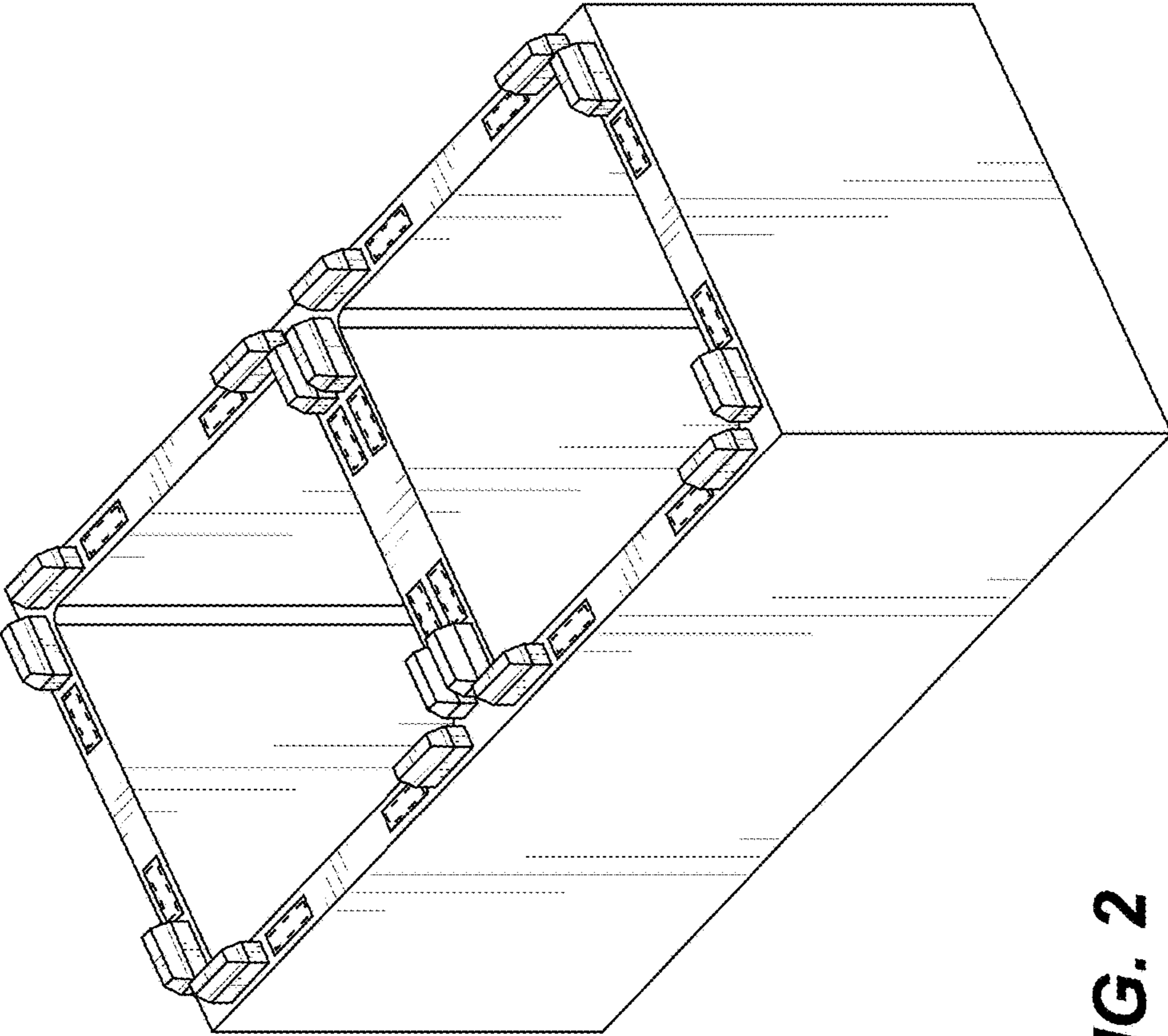

FIG. 2

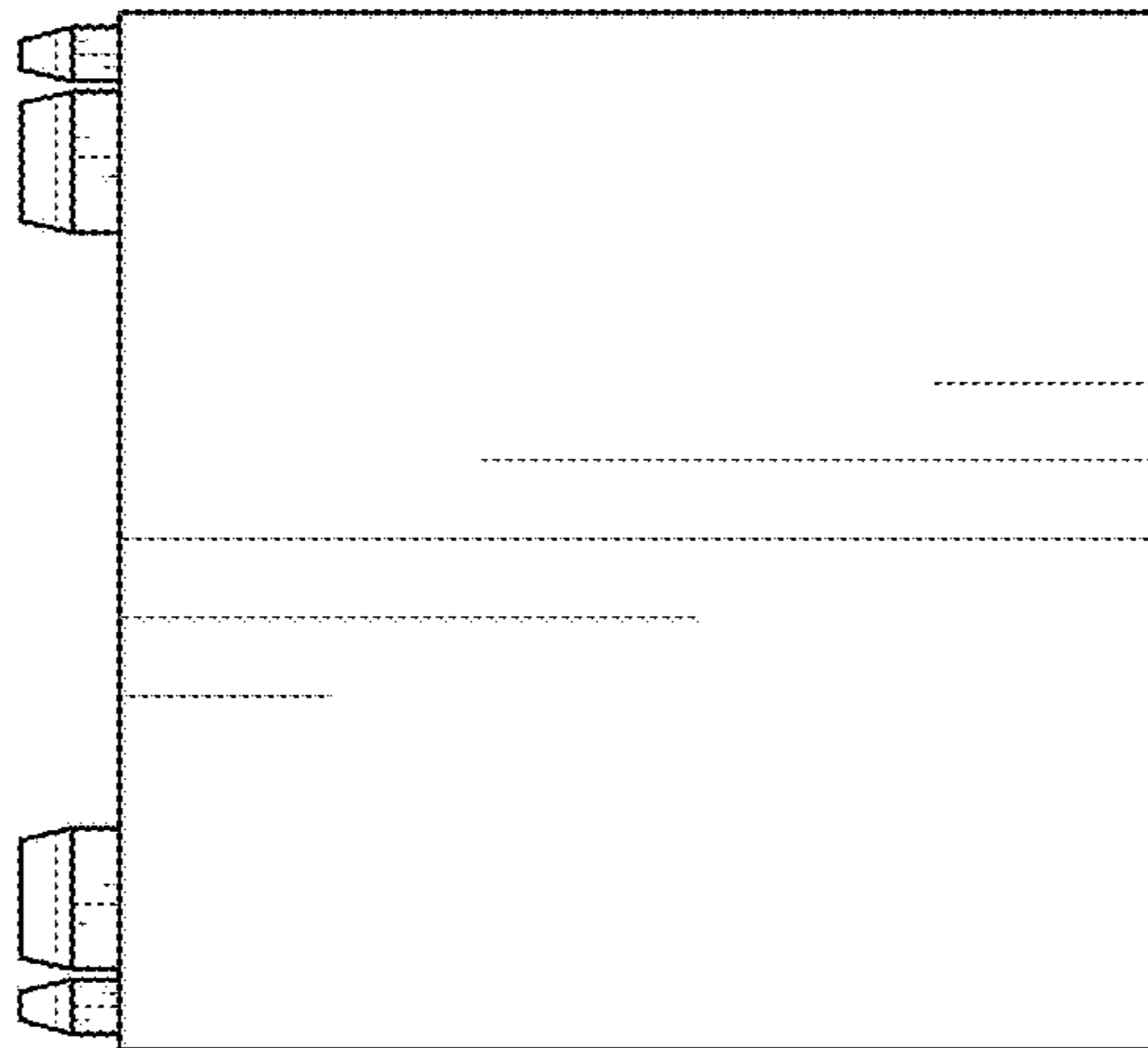

FIG. 3

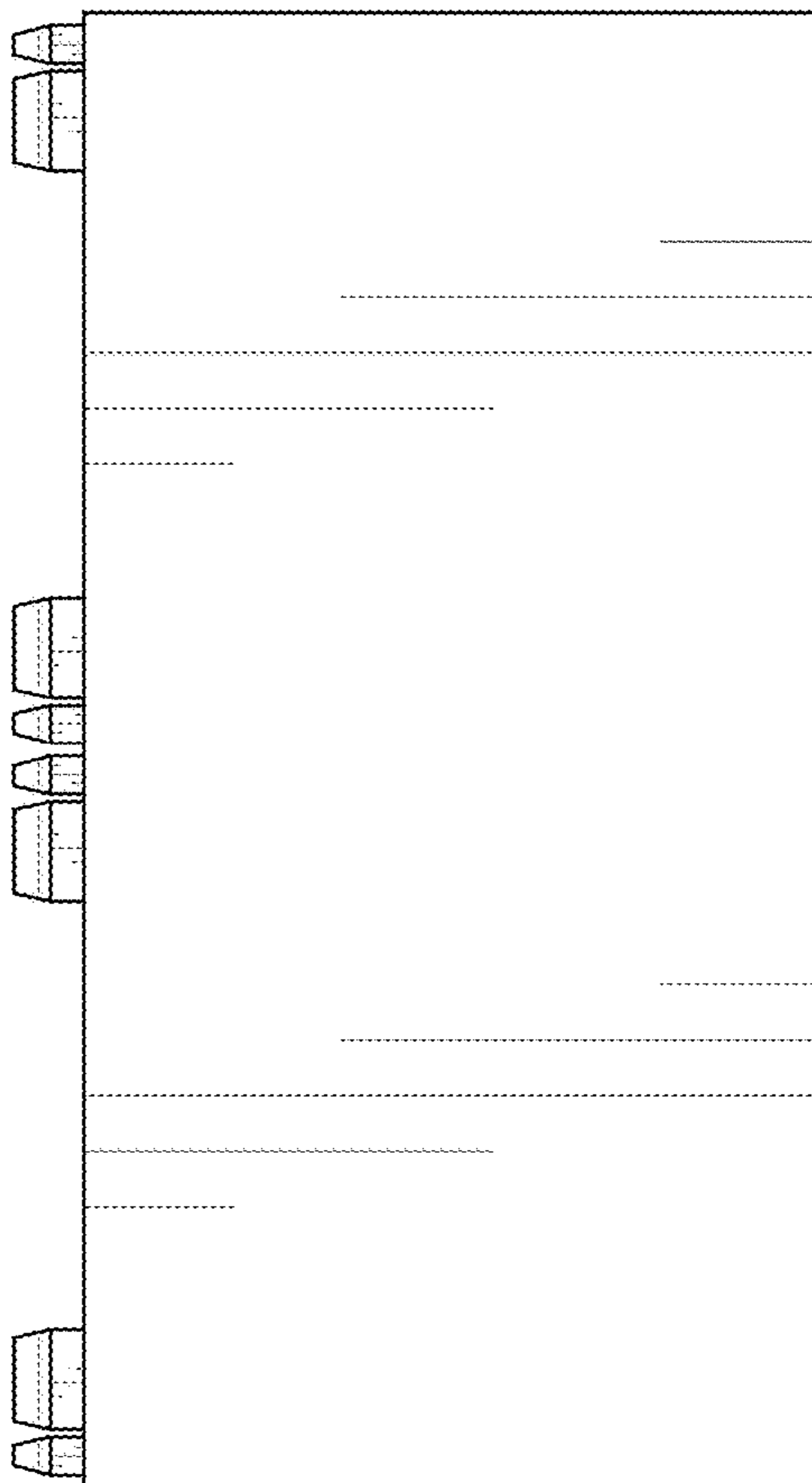

FIG. 4

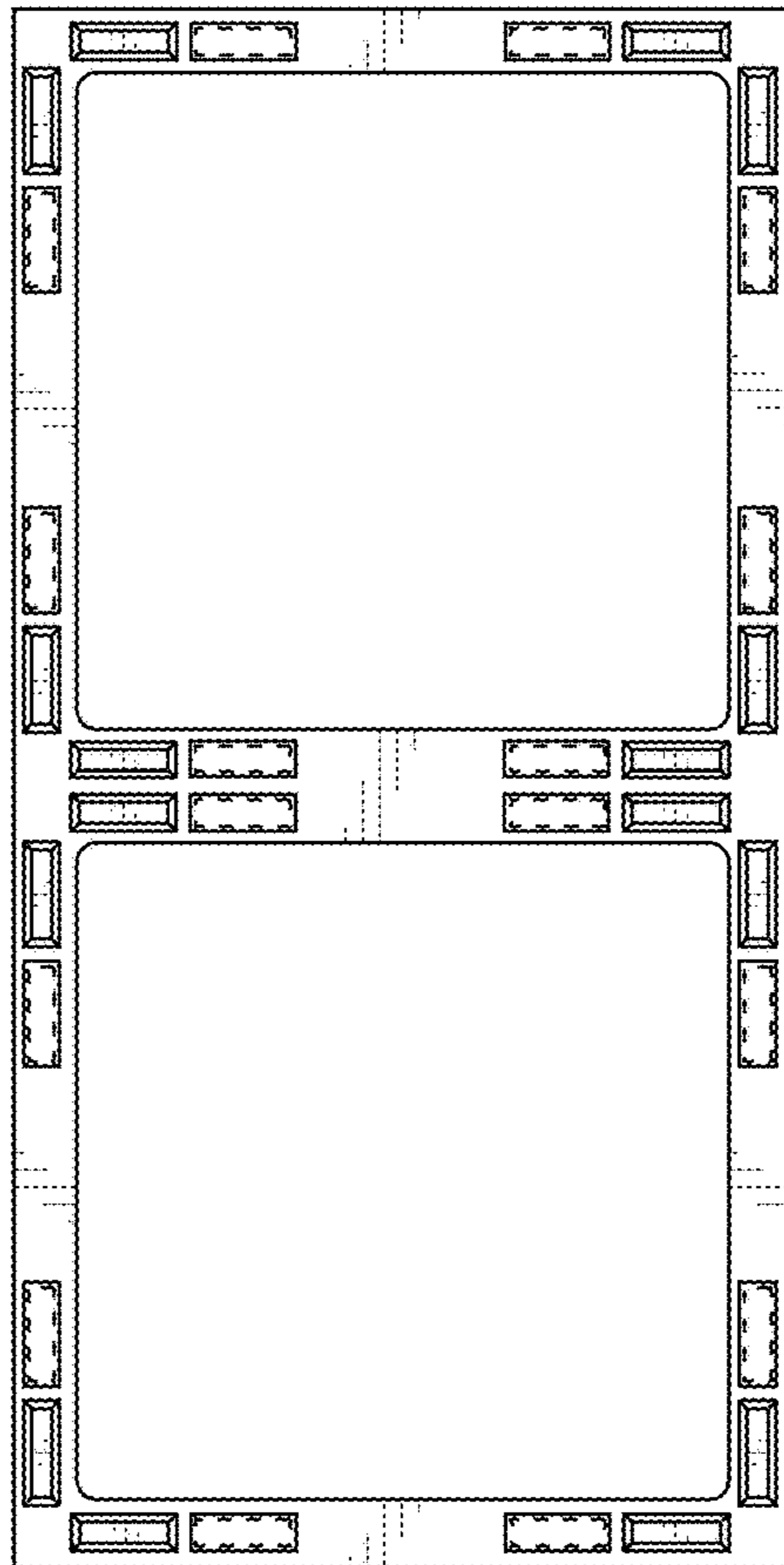

FIG. 5

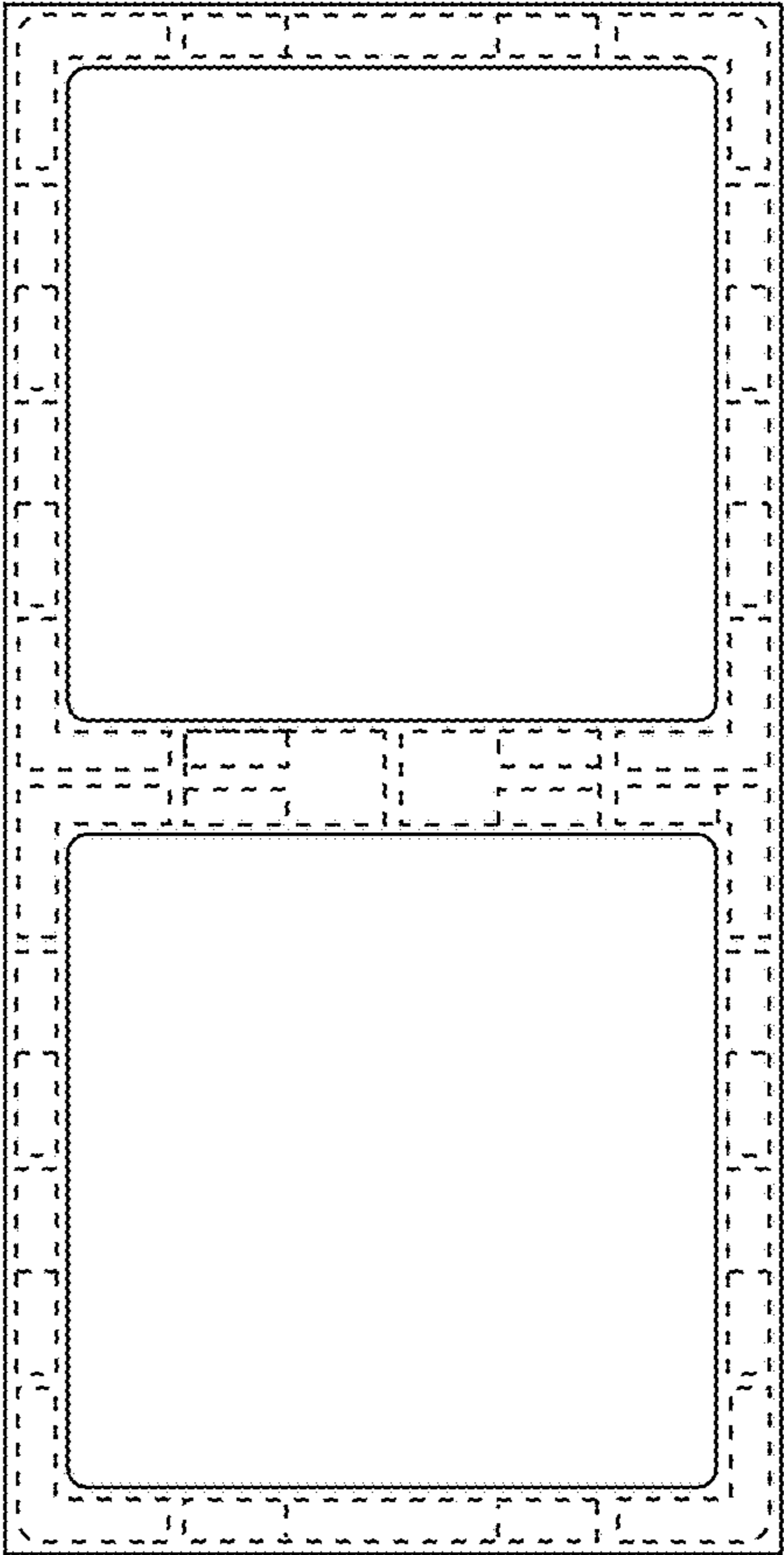

FIG. 6