

US00D854989S

(12) **United States Design Patent**  
**Sarreméjean**

(10) **Patent No.:** **US D854,989 S**

(45) **Date of Patent:** **\*\* Jul. 30, 2019**

(54) **FRONT FENDER FOR A VEHICLE**

(71) Applicant: **Bayerische Motoren Werke Aktiengesellschaft, Munich (DE)**

(72) Inventor: **Julien Thibaut Thomas Sarreméjean, Munich (DE)**

(73) Assignee: **Bayerische Motoren Werke Aktiengesellschaft, Munich (DE)**

(\*\*) Term: **15 Years**

(21) Appl. No.: **29/630,701**

(22) Filed: **Dec. 22, 2017**

(30) **Foreign Application Priority Data**

Jun. 30, 2017 (DE) ..... 40 2017 100 780

(51) **LOC (11) Cl.** ..... **12-16**

(52) **U.S. Cl.**  
USPC ..... **D12/184**

(58) **Field of Classification Search**  
USPC ..... D12/114, 181, 184; D15/28  
CPC ..... B62D 25/16; B62D 25/18  
See application file for complete search history.

(56) **References Cited**

**U.S. PATENT DOCUMENTS**

D511,486 S	11/2005	Nagashima	
D665,319 S	8/2012	Huet	
D686,552 S	7/2013	Weil	
9,278,716 B1 *	3/2016	Joseph	B62D 25/18
D756,870 S *	5/2016	Tsutamori	D12/184
D758,935 S *	6/2016	Platto	D12/184
D762,151 S	7/2016	Luk	
9,403,557 B1 *	8/2016	Sharma	C21D 1/06
9,487,238 B2 *	11/2016	Iwano	B62D 25/025
D775,031 S *	12/2016	Frascella	D12/184
D787,395 S *	5/2017	Curic	D12/181

9,669,876 B2 *	6/2017	Iwano	B62D 25/04
9,738,322 B2 *	8/2017	Matthiessen	B62D 25/02
D803,119 S *	11/2017	Beermann	D12/184
D803,741 S *	11/2017	Tsubaki	D12/184
D805,013 S *	12/2017	Whitla	D12/181

(Continued)

**FOREIGN PATENT DOCUMENTS**

EM	004521342-0001	11/2017
WO	WO DM/065775	11/2004

(Continued)

*Primary Examiner* — Susan Bennett Hattan

*Assistant Examiner* — Suzanne E Tisdell

(74) *Attorney, Agent, or Firm* — Crowell & Moring LLP

(57) **CLAIM**

The ornamental design for a front fender for a vehicle, as shown and described.

**DESCRIPTION**

This application contains subject matter related to the following co-pending U.S. design patent applications: Application Ser. No. 29/594,687, filed Feb. 22, 2017 and entitled "Front Fender for a Vehicle"; Application Ser. No. 29/607,495, filed Jun. 14, 2017 and entitled "Front Fender for a Vehicle"; Application Ser. No. 29/630,692, filed herewith and entitled "Vehicle, Toy, and/or Replicas Thereof"; and Application Ser. No. 29/630,695, filed herewith and entitled "Vehicle, Toy, and/or Replicas Thereof".

FIG. 1 is a front view of a front fender for a vehicle according to the design;

FIG. 2 is a left, front perspective view thereof;

FIG. 3 is a right, front perspective view thereof;

FIG. 4 is a left side view thereof;

FIG. 5 is a right side view thereof;

FIG. 6 is a top view thereof;

FIG. 7 is a bottom view thereof; and,

FIG. 8 is a rear view thereof.

**1 Claim, 8 Drawing Sheets**

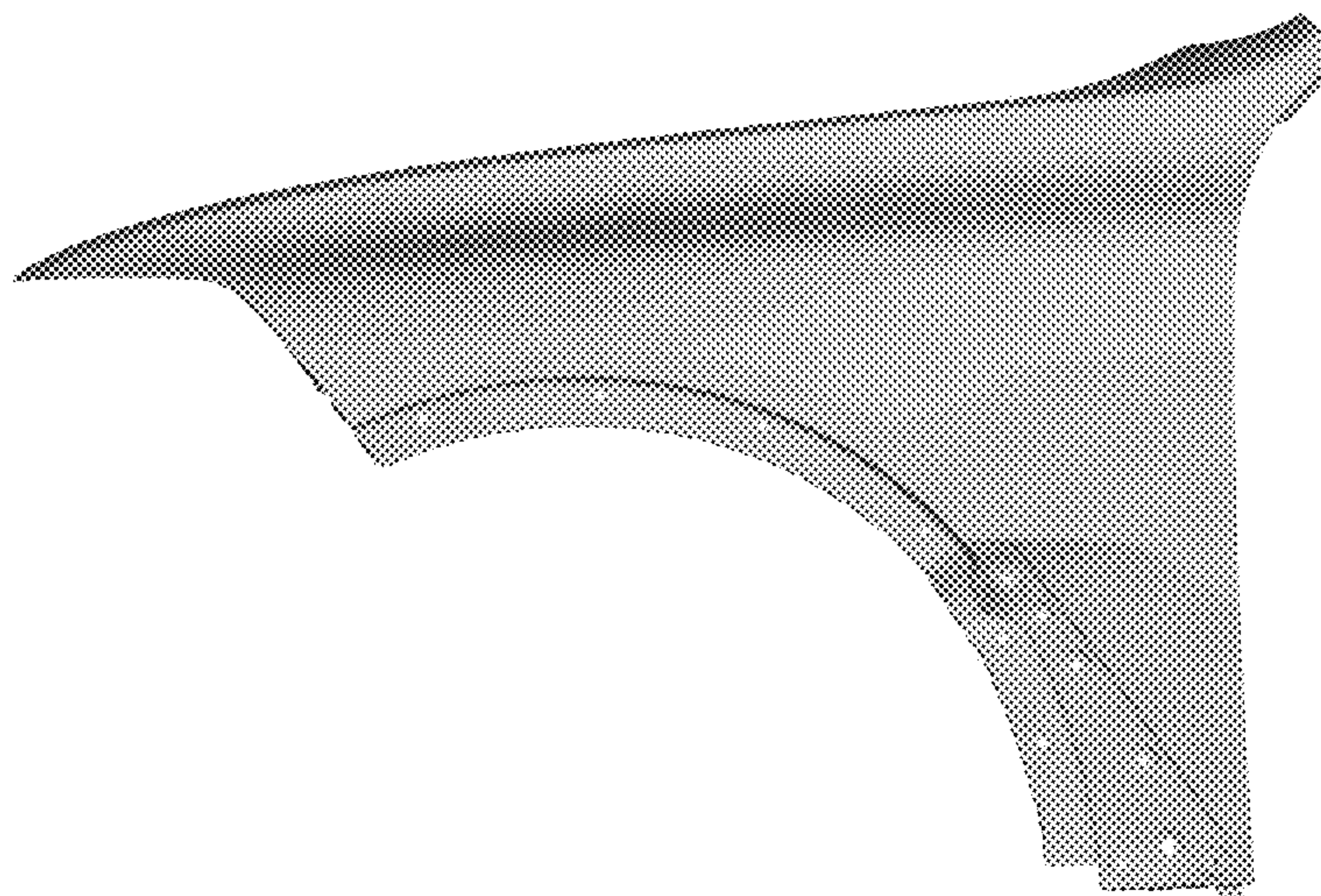

(56)

**References Cited**

U.S. PATENT DOCUMENTS

D806,622 S \* 1/2018 Granlund ..... D12/184  
D807,261 S \* 1/2018 Zavatski ..... D12/184  
9,890,966 B2 \* 2/2018 Mueller ..... B62D 25/16  
D817,829 S \* 5/2018 Behmer ..... D12/184  
D820,751 S \* 6/2018 Luk ..... D12/184  
D823,741 S \* 7/2018 Kim ..... D12/169  
10,023,241 B2 \* 7/2018 Umemoto ..... B62D 25/161  
10,035,543 B2 \* 7/2018 Sato ..... B60J 5/0444  
D826,811 S \* 8/2018 Lim ..... D12/184  
D827,527 S \* 9/2018 Loeb ..... D12/184  
D827,528 S \* 9/2018 Gueler ..... D12/184  
D827,529 S \* 9/2018 Al Attar ..... D12/184  
D828,254 S \* 9/2018 Simm ..... D12/184  
10,077,085 B2 \* 9/2018 Pfaffelhuber ..... B62D 27/02

FOREIGN PATENT DOCUMENTS

WO WO DM/074951 5/2011  
WO WO DM/076560 2/2012  
WO WO DM/094978 8/2017  
WO WO DM/096612 12/2017

\* cited by examiner



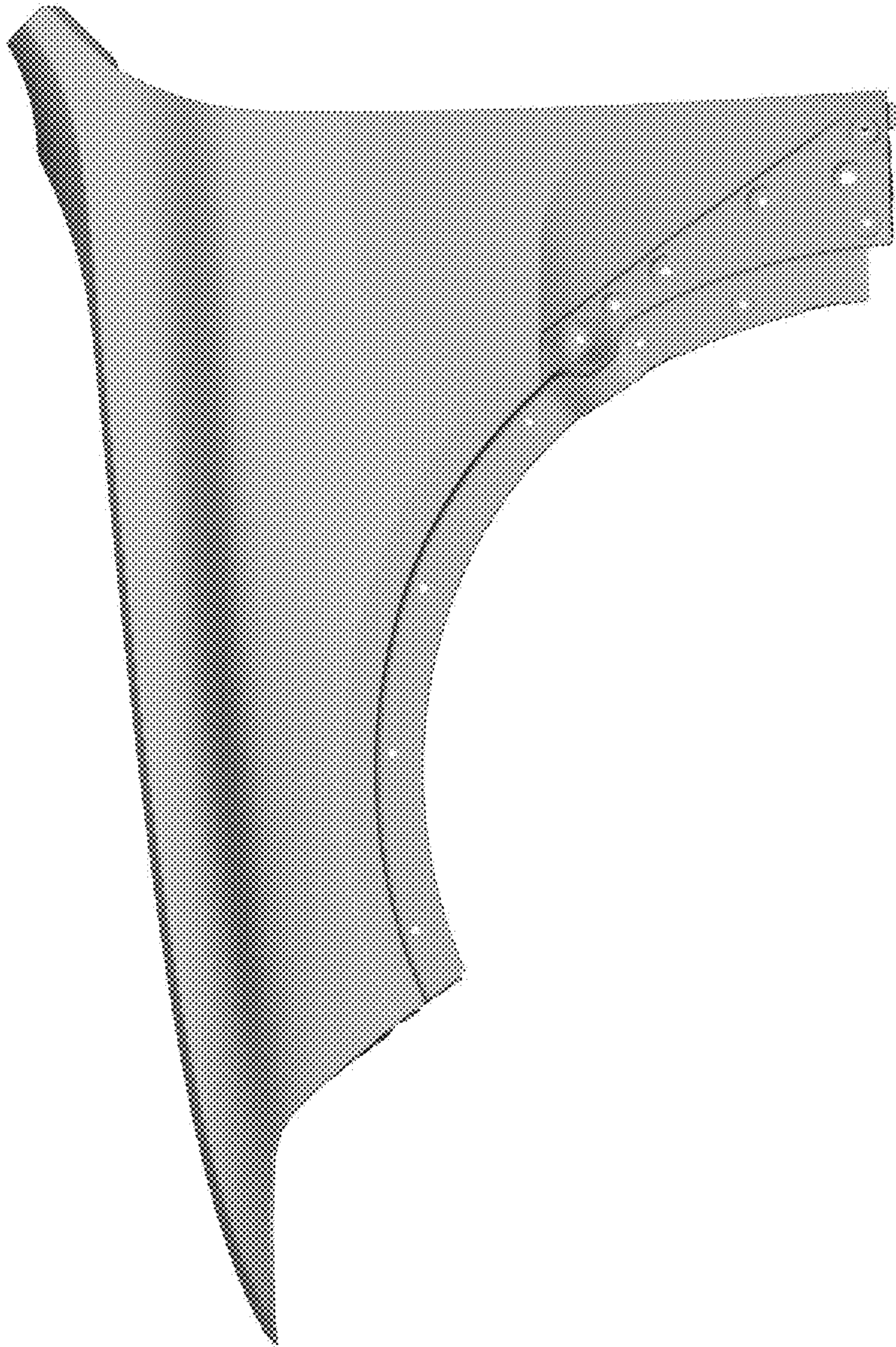

Fig. 1

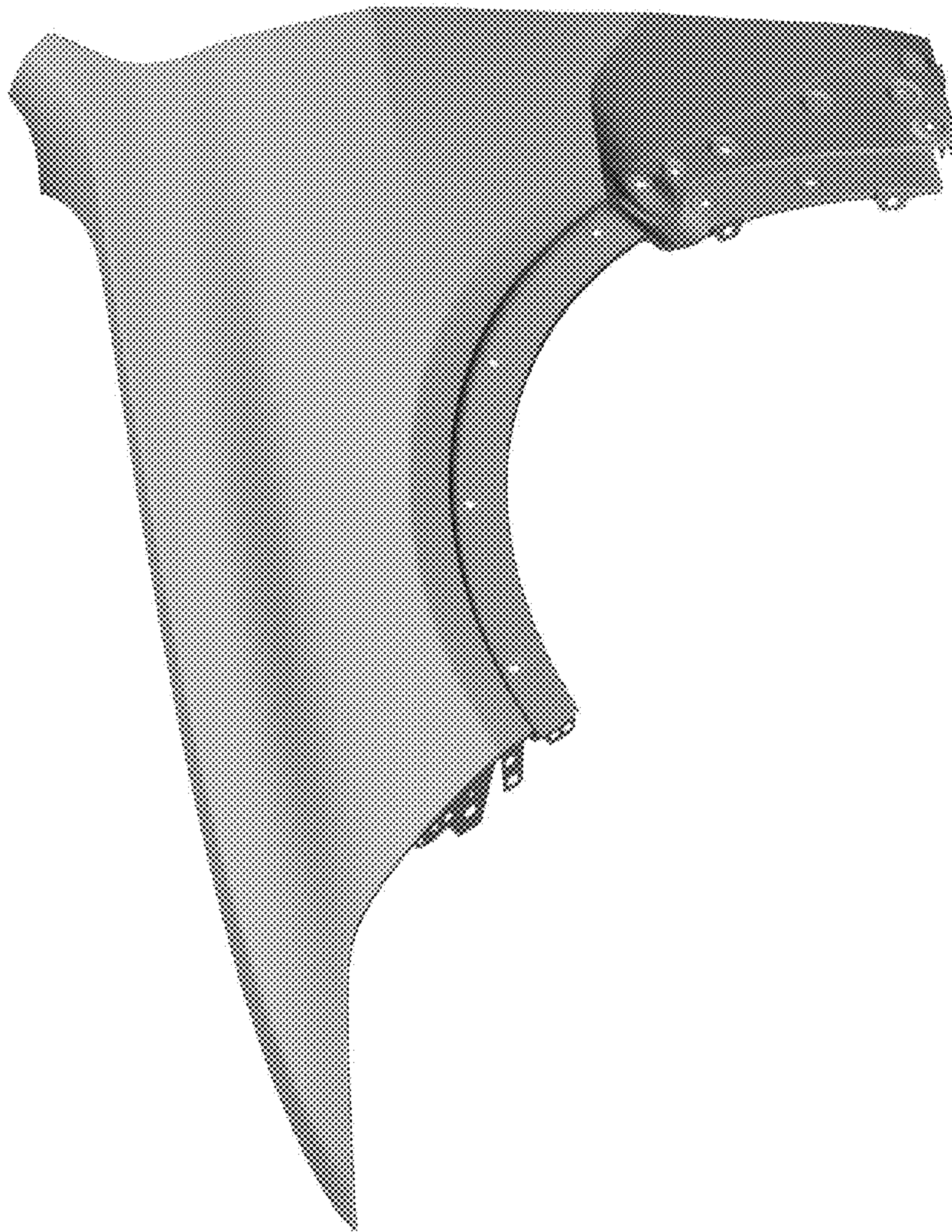

Fig. 2



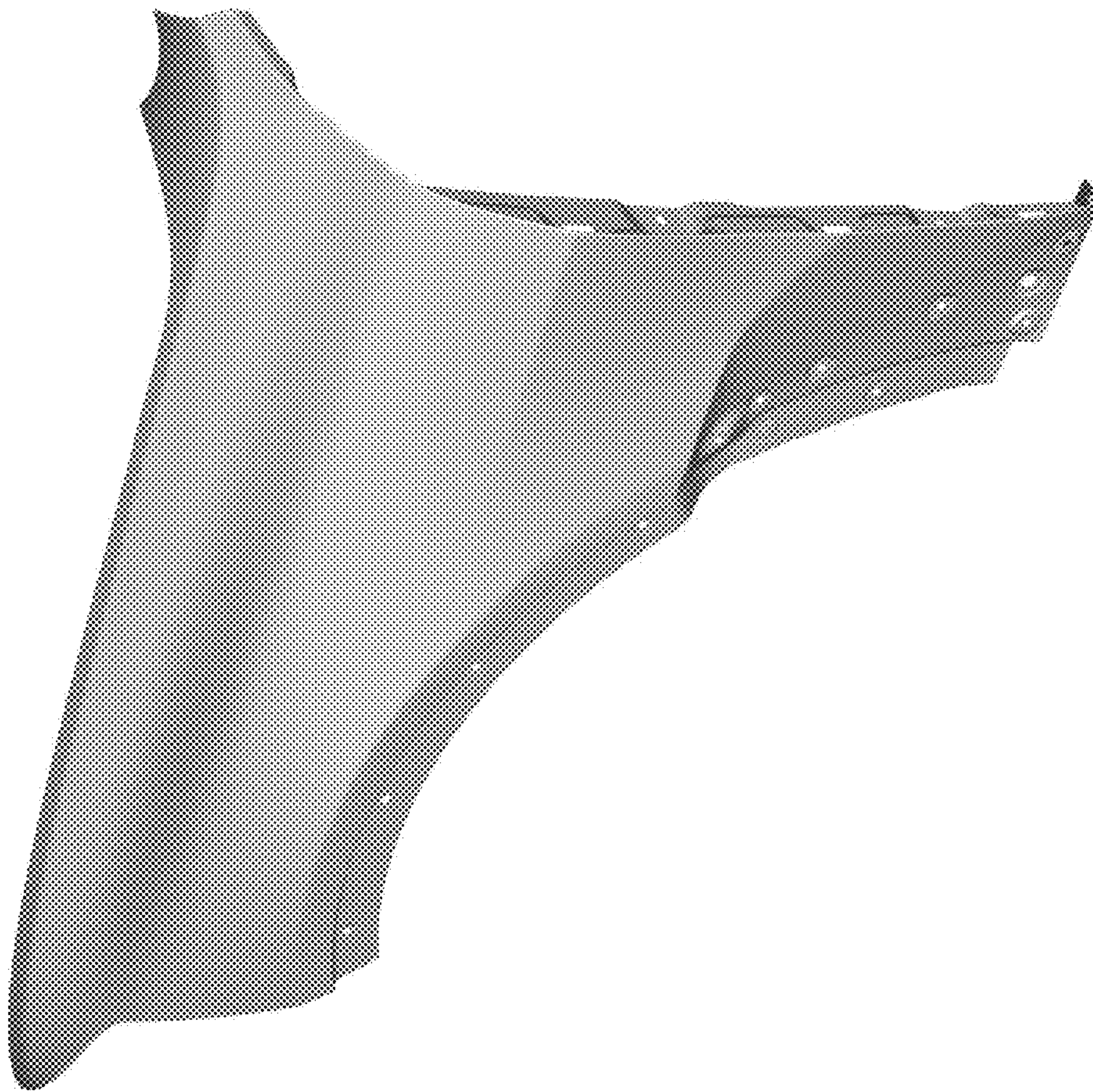

Fig. 3

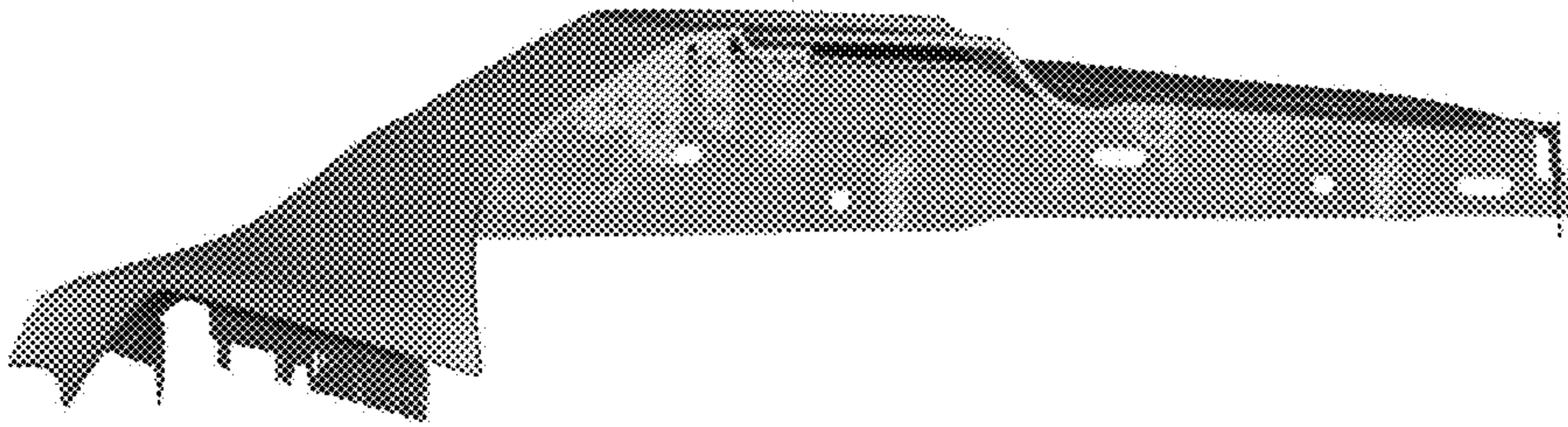

Fig. 4



Fig. 5

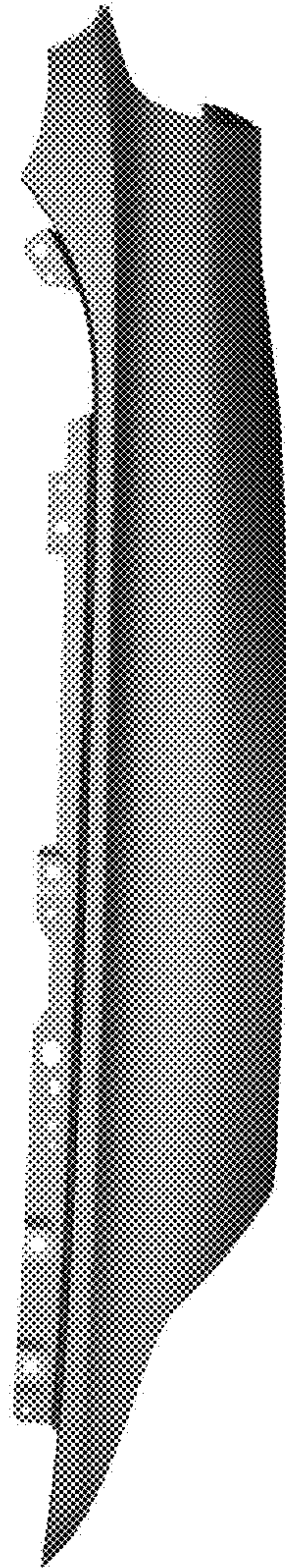

Fig. 6



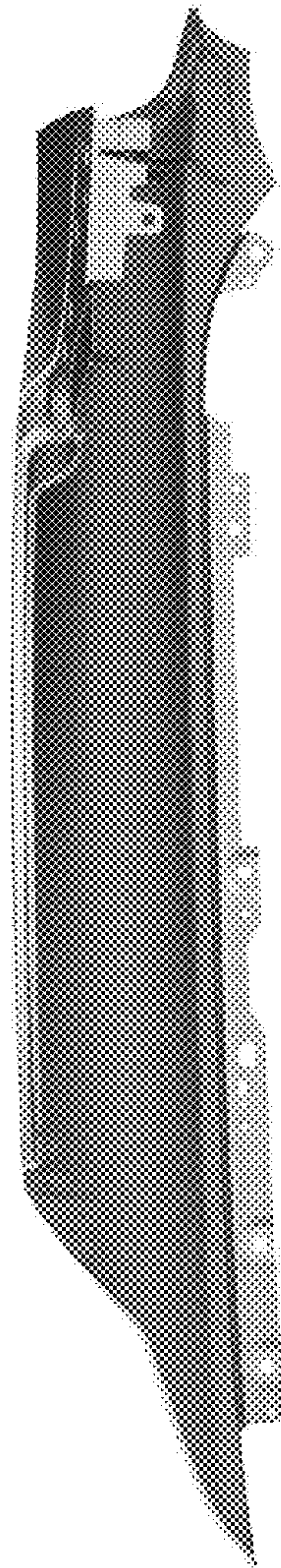

Fig. 7

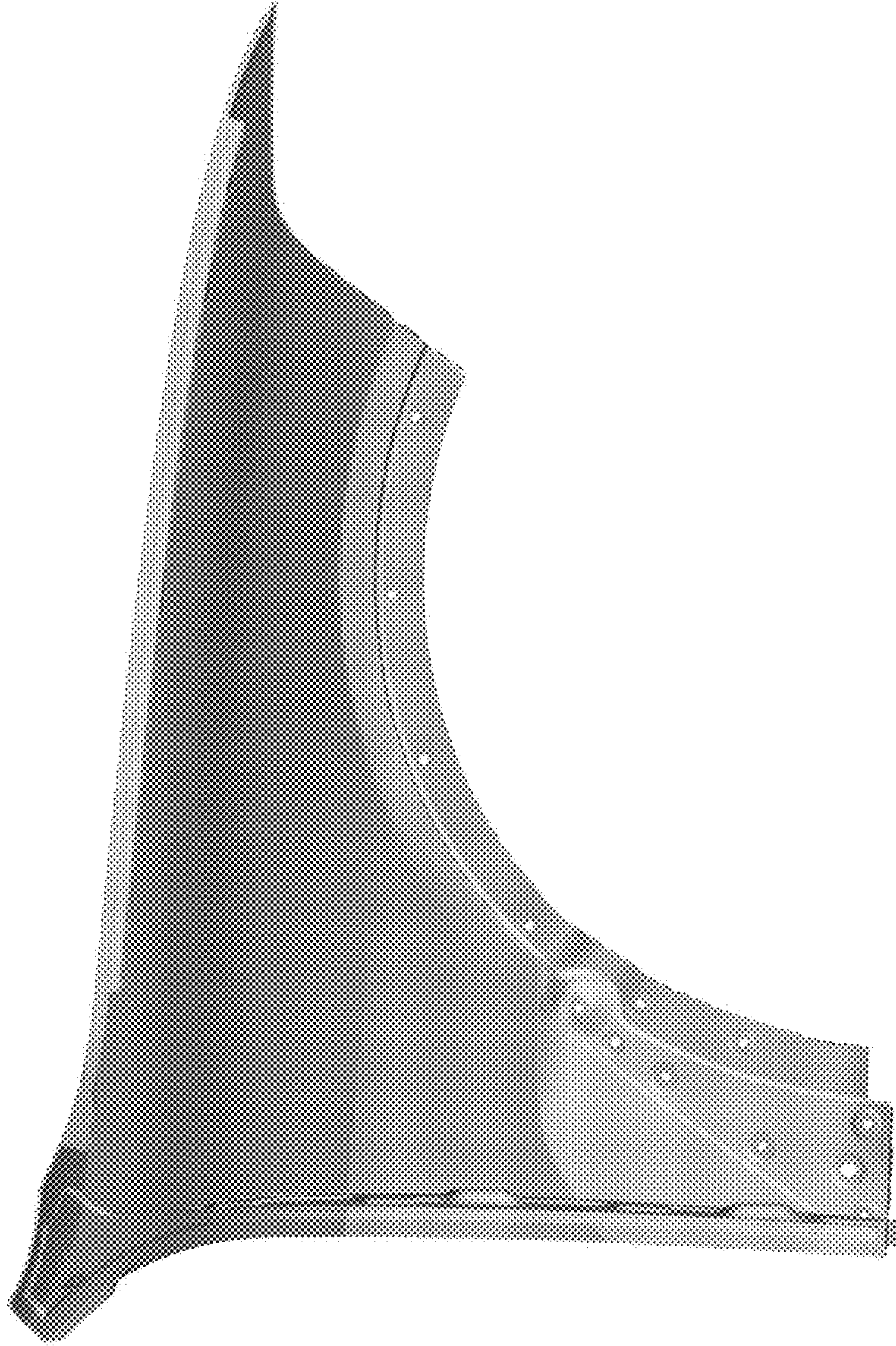

Fig. 8

UNITED STATES PATENT AND TRADEMARK OFFICE  
**CERTIFICATE OF CORRECTION**

PATENT NO. : D854,989 S  
APPLICATION NO. : 29/630701  
DATED : July 30, 2019  
INVENTOR(S) : Julien Thibaut Thomas Sarreméjean

Page 1 of 10

It is certified that error appears in the above-identified patent and that said Letters Patent is hereby corrected as shown below:

On the Title Page

Delete the title page and substitute therefore with the attached title page consisting of the corrected illustrative figure.

In the Drawings

Please replace FIGS. 1-8 with FIGS. 1-8 as shown on the attached pages.

Signed and Sealed this  
Twenty-second Day of October, 2019

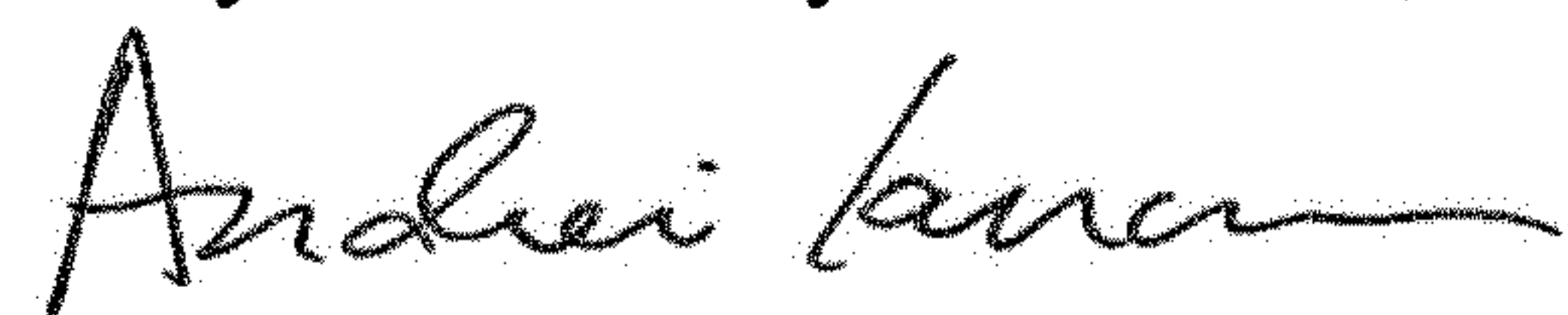

Andrei Iancu  
*Director of the United States Patent and Trademark Office*



(12) **United States Design Patent** (10) **Patent No.:** **US D854,989 S**  
**Sarreméjean** (45) **Date of Patent:** **\*\* Jul. 30, 2019**

(54) **FRONT FENDER FOR A VEHICLE**

9,669,876 B2 \* 6/2017 Iwano ..... B62D 25/04  
 9,738,322 B2 \* 8/2017 Matthiessen ..... B62D 25/02  
 D803,119 S \* 11/2017 Beermann ..... D12/184  
 D803,741 S \* 11/2017 Tsubaki ..... D12/184  
 D805,013 S \* 12/2017 Whitla ..... D12/181

(71) Applicant: **Bayerische Motoren Werke Aktiengesellschaft, Munich (DE)**

(Continued)

(72) Inventor: **Julien Thibaut Thomas Sarreméjean, Munich (DE)**

**FOREIGN PATENT DOCUMENTS**

(73) Assignee: **Bayerische Motoren Werke Aktiengesellschaft, Munich (DE)**

EM 004521342-0001 11/2017  
 WO WO DM/065775 11/2004

(Continued)

(\*\*) Term: **15 Years**

*Primary Examiner* — Susan Bennett Hattan

(21) Appl. No.: **29/630,701**

*Assistant Examiner* — Suzanne E Tisdell

(22) Filed: **Dec. 22, 2017**

(74) *Attorney, Agent, or Firm* — Crowell & Moring LLP

(30) **Foreign Application Priority Data**

(57) **CLAIM**

The ornamental design for a front fender for a vehicle, as shown and described.

Jun. 30, 2017 (DE) ..... 40 2017 100 780

**DESCRIPTION**

(51) **LOC (11) CL.** ..... **12-16**

(52) **U.S. CL.** ..... **D12/184**

USPC ..... **D12/184**

(58) **Field of Classification Search**

USPC ..... D12/114, 181, 184; D15/28

CPC ..... B62D 25/16; B62D 25/18

See application file for complete search history.

(56) **References Cited**

**U.S. PATENT DOCUMENTS**

D511,486 S 11/2005 Nagashima  
 D665,319 S 8/2012 Huet  
 D686,552 S 7/2013 Weil  
 9,278,716 B1 \* 3/2016 Joseph ..... B62D 25/18  
 D756,870 S \* 5/2016 Tsutamori ..... D12/184  
 D758,935 S \* 6/2016 Platto ..... D12/184  
 D762,151 S 7/2016 Luk  
 9,403,557 B1 \* 8/2016 Sharma ..... C21D 1/06  
 9,487,238 B2 \* 11/2016 Iwano ..... B62D 25/025  
 D775,031 S \* 12/2016 Frascella ..... D12/184  
 D787,395 S \* 5/2017 Curic ..... D12/181

This application contains subject matter related to the following co-pending U.S. design patent applications: Application Ser. No. 29/594,687, filed Feb. 22, 2017 and entitled "Front Fender for a Vehicle"; Application Ser. No. 29/607,495, filed Jun. 14, 2017 and entitled "Front Fender for a Vehicle"; Application Ser. No. 29/630,692, filed herewith and entitled "Vehicle, Toy, and/or Replicas Thereof"; and Application Ser. No. 29/630,695, filed herewith and entitled "Vehicle, Toy, and/or Replicas Thereof". FIG. 1 is a front view of a front fender for a vehicle according to the design; FIG. 2 is a left, front perspective view thereof; FIG. 3 is a right, front perspective view thereof; FIG. 4 is a left side view thereof; FIG. 5 is a right side view thereof; FIG. 6 is a top view thereof; FIG. 7 is a bottom view thereof; and, FIG. 8 is a rear view thereof.

**1 Claim, 8 Drawing Sheets**

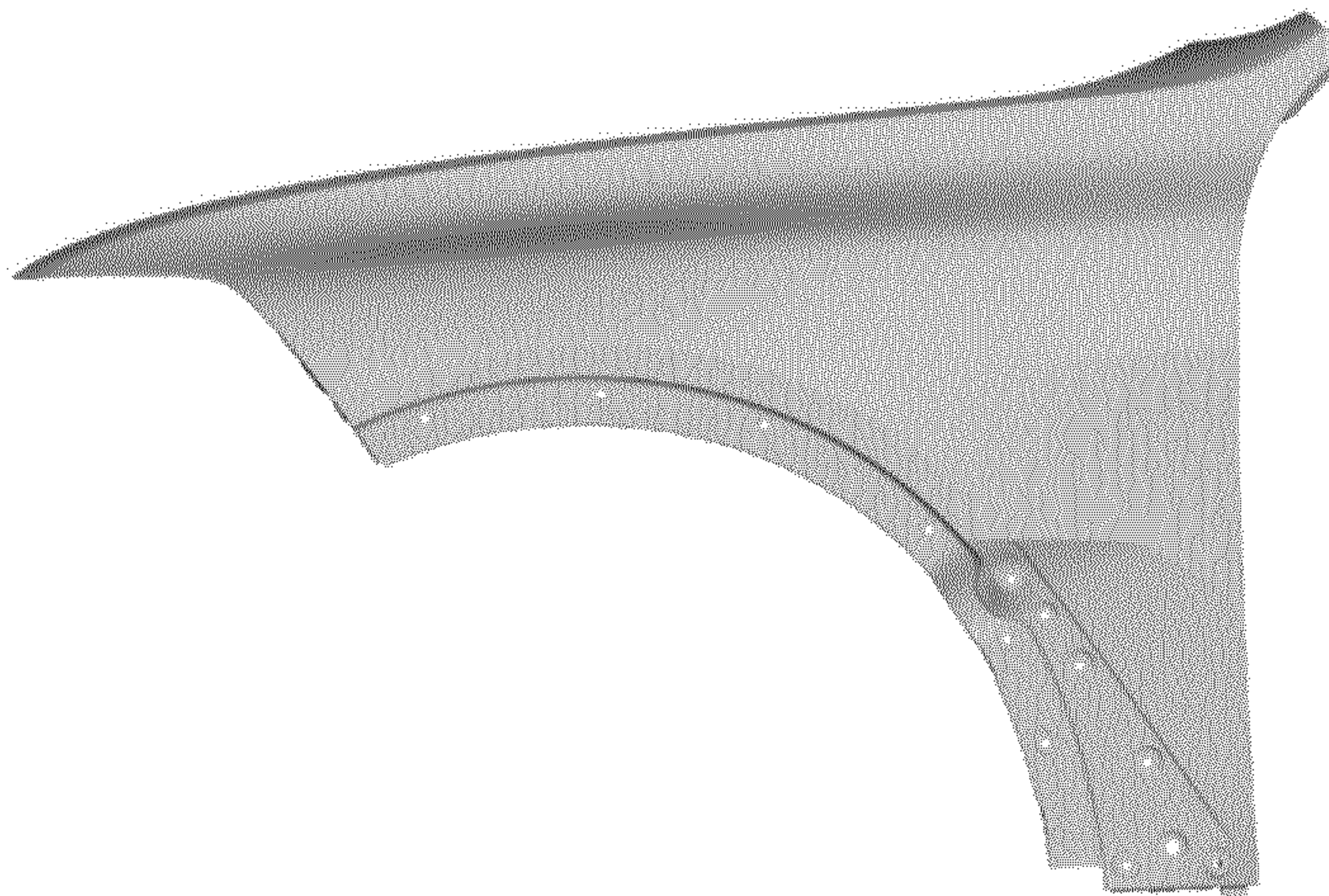





Fig. 1



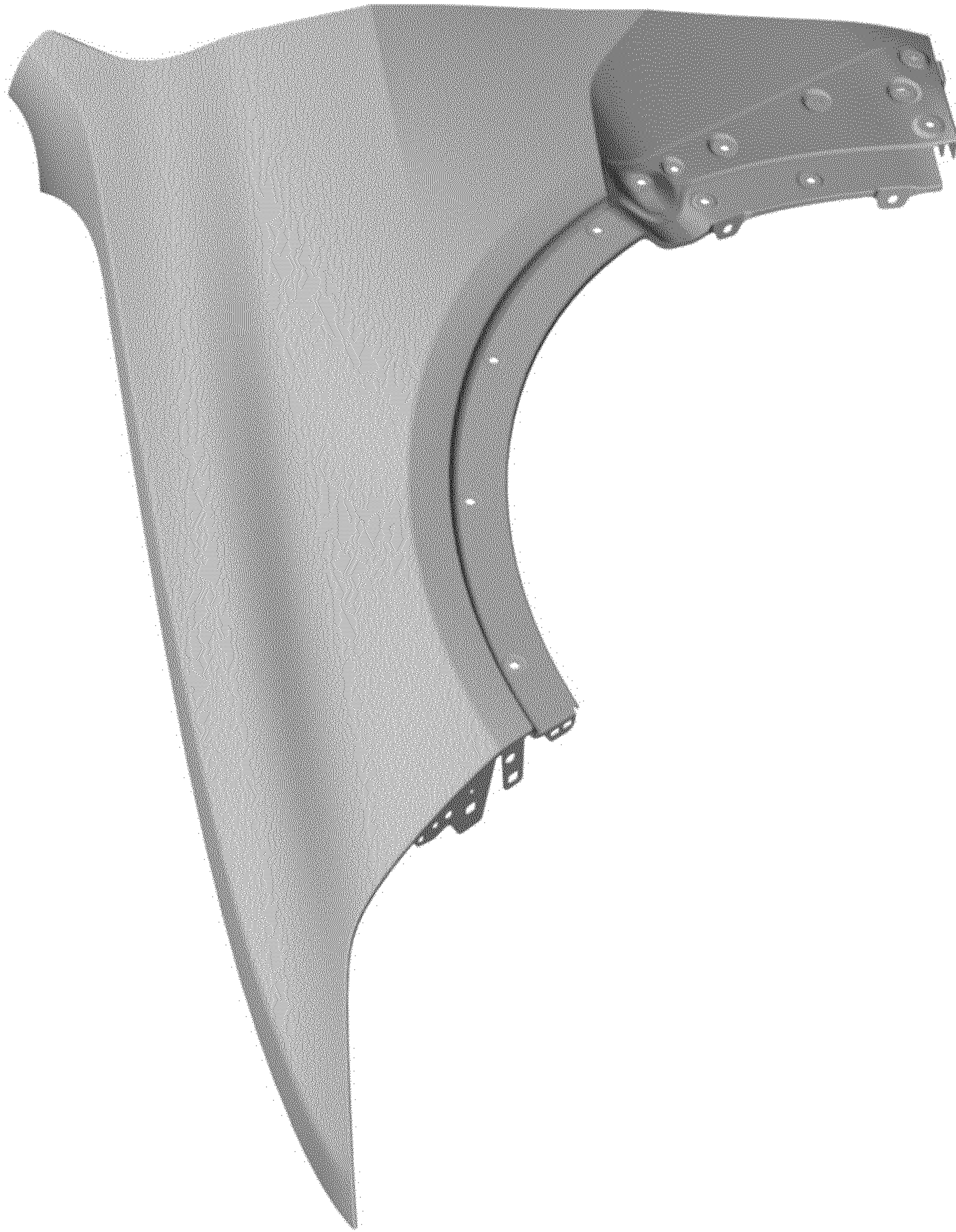

Fig. 2



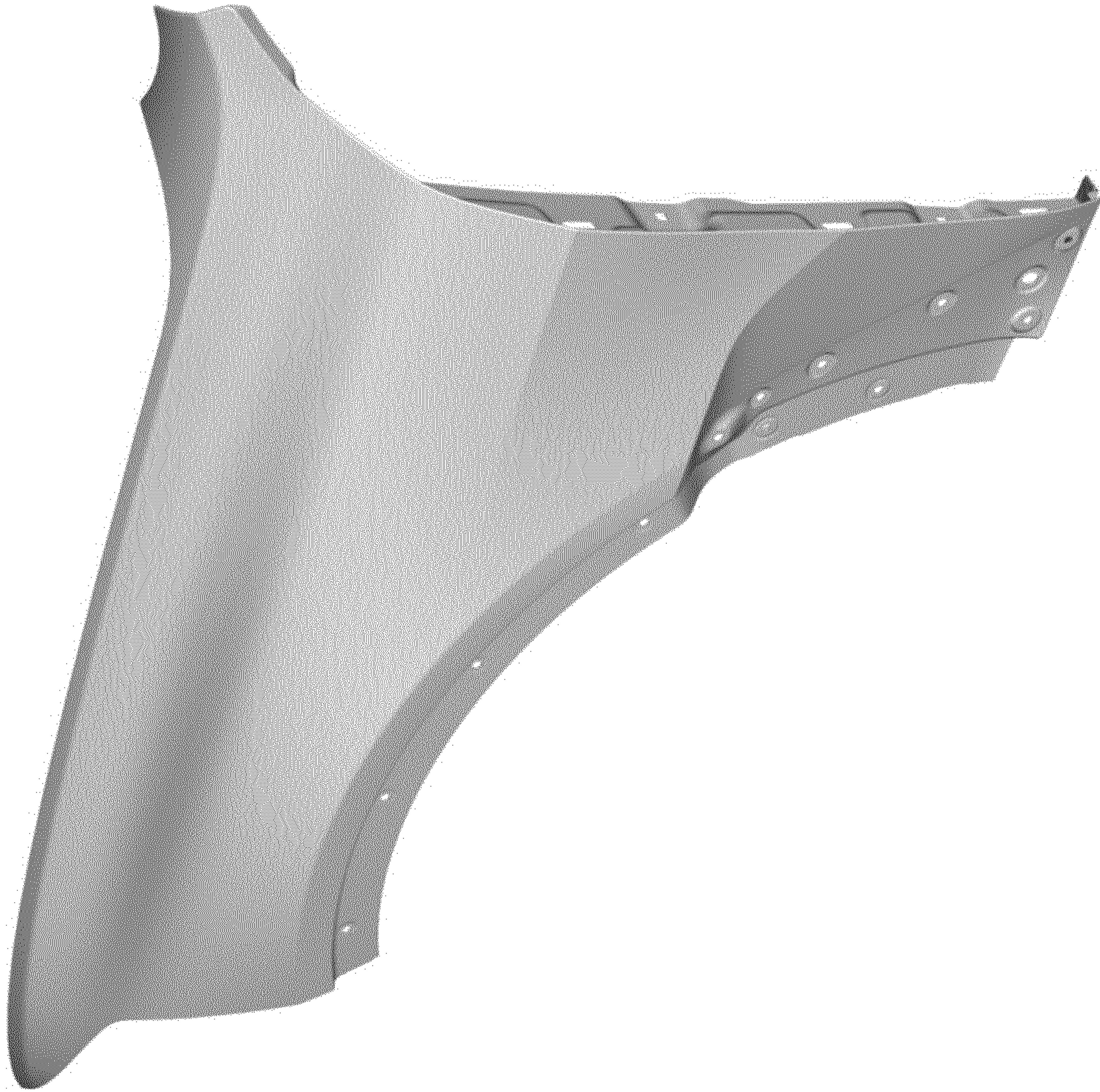

Fig. 3

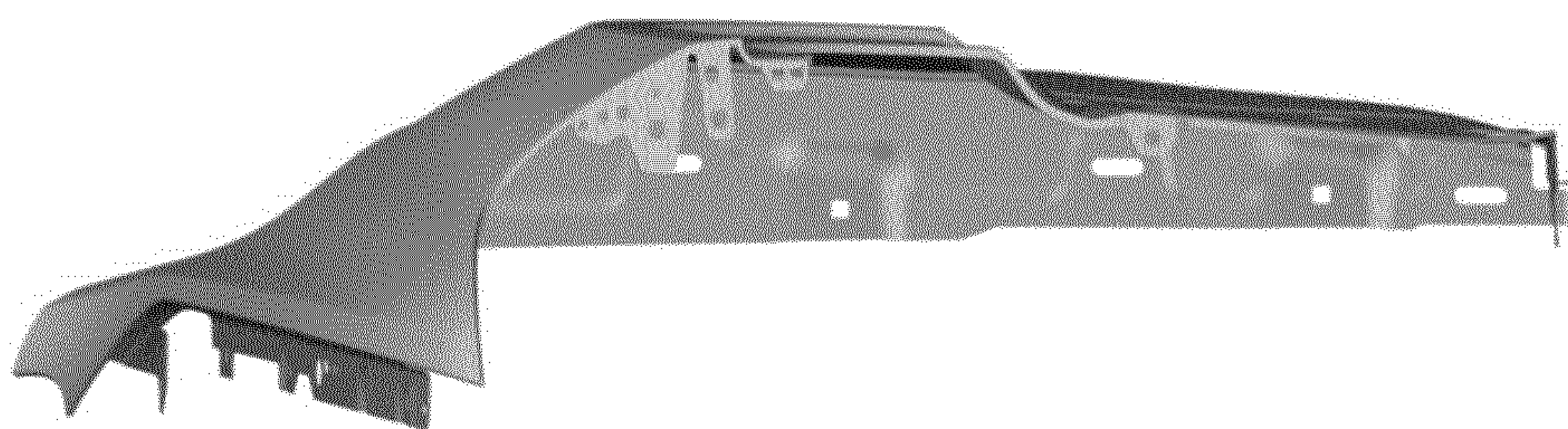

Fig. 4

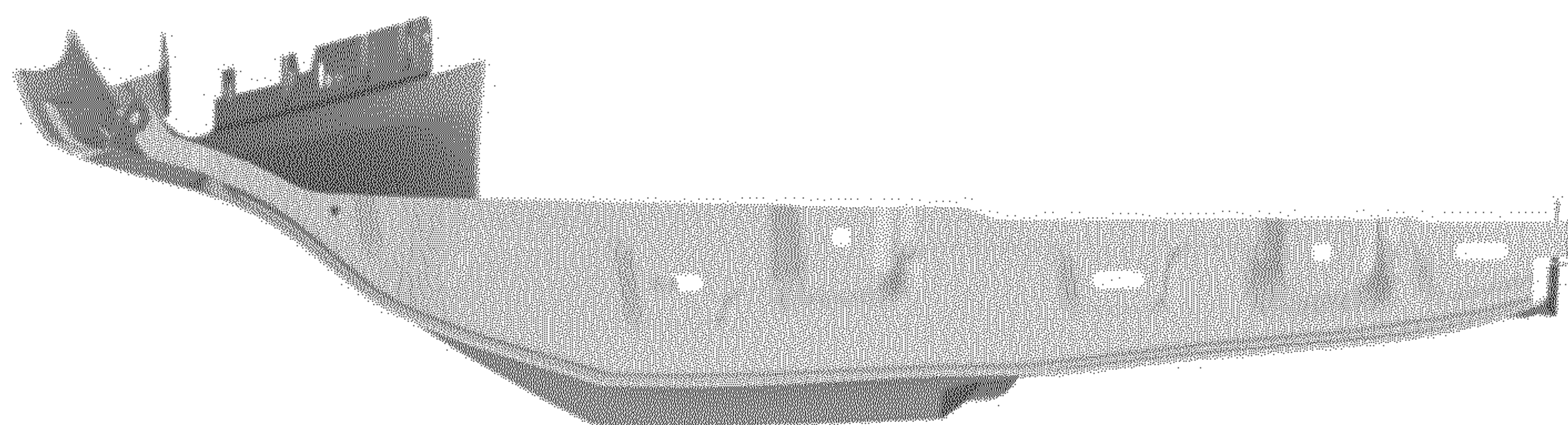

Fig. 5



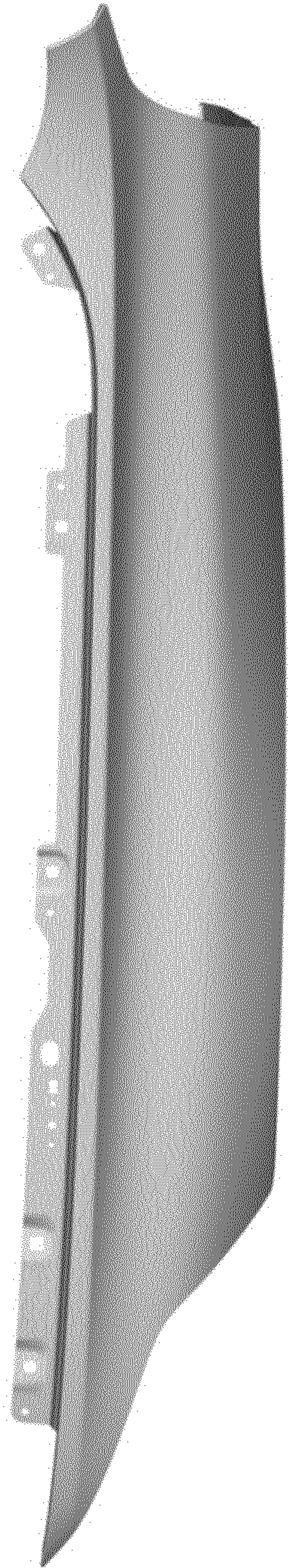

Fig. 6

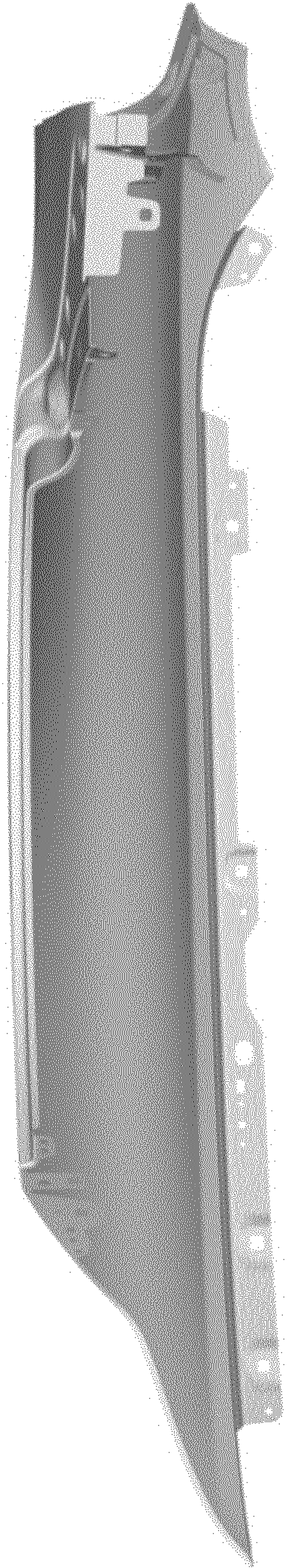

Fig. 7



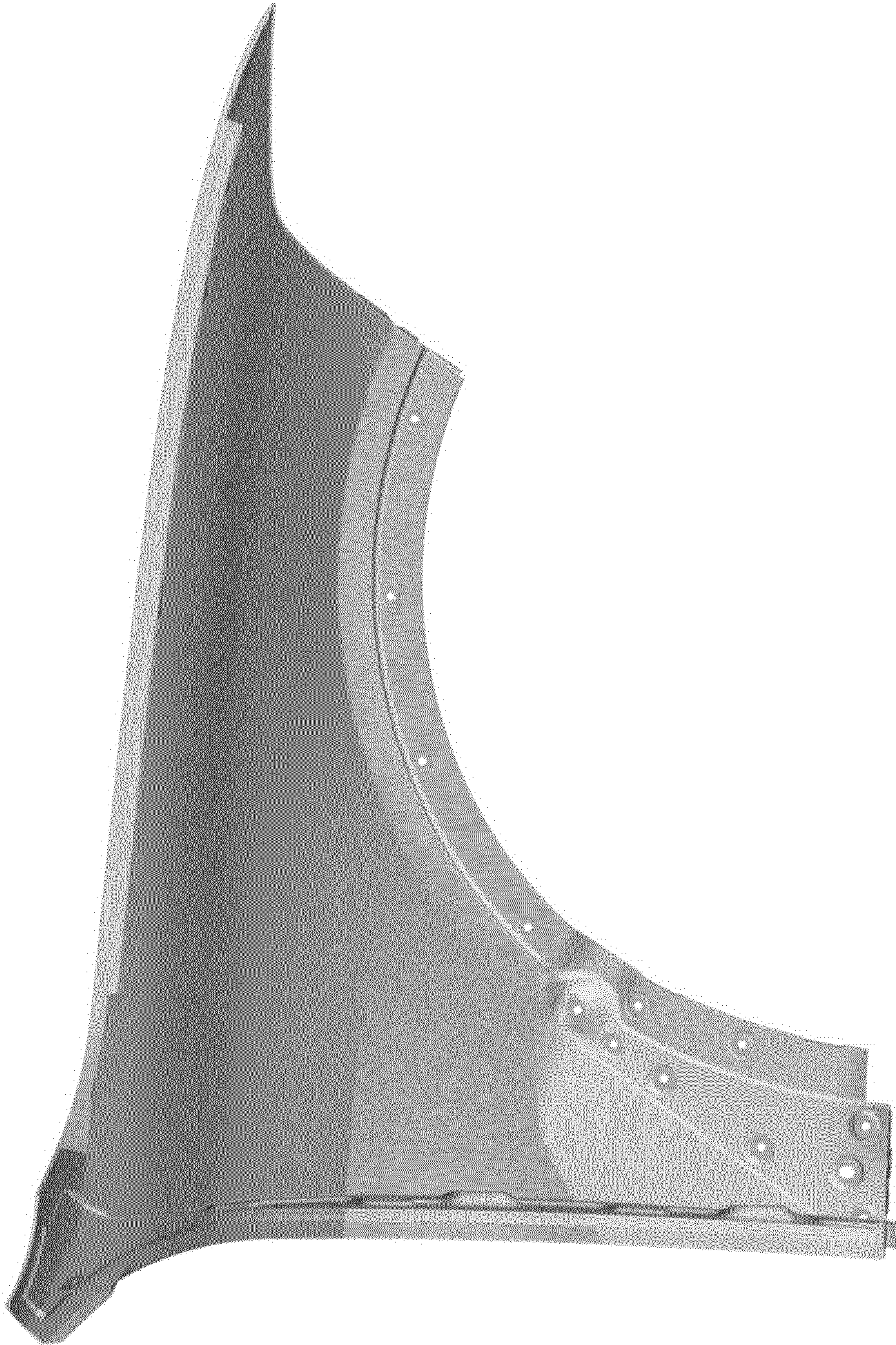

Fig. 8



UNITED STATES PATENT AND TRADEMARK OFFICE  
**CERTIFICATE OF CORRECTION**

PATENT NO. : D854,989 S  
APPLICATION NO. : 29/630701  
DATED : July 30, 2019  
INVENTOR(S) : Julien Thibaut Thomas Sarreméjean

Page 1 of 10

It is certified that error appears in the above-identified patent and that said Letters Patent is hereby corrected as shown below:

On the Title Page

Delete the title page and substitute therefore with the attached title page consisting of the corrected illustrative figure.

In the Drawings

Please replace FIGS. 1-8 with FIGS. 1-8 as shown on the attached pages.

Signed and Sealed this  
Thirty-first Day of December, 2019

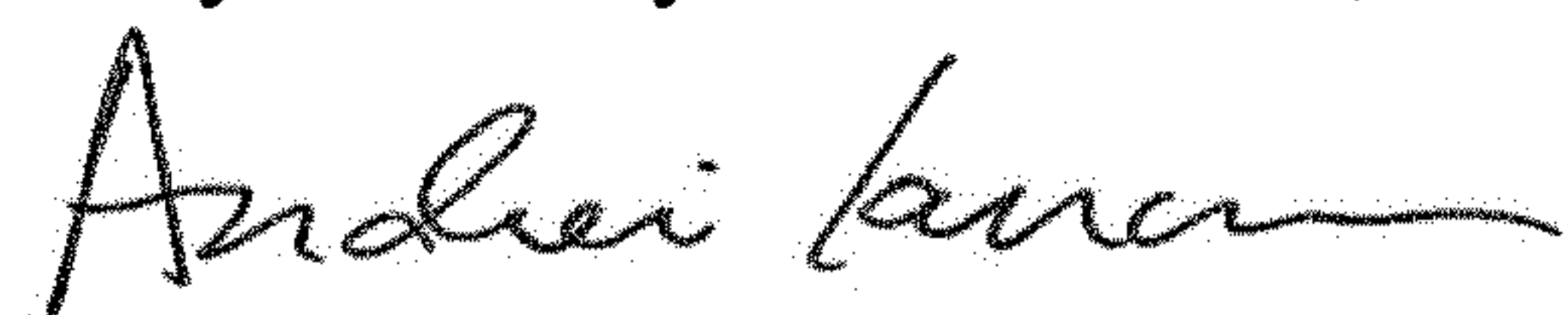

Andrei Iancu  
*Director of the United States Patent and Trademark Office*

(12) **United States Design Patent** (10) **Patent No.:** **US D854,989 S**  
**Sarreméjean** (45) **Date of Patent:** **\*\* Jul. 30, 2019**

(54) **FRONT FENDER FOR A VEHICLE**

(71) Applicant: **Bayerische Motoren Werke  
Aktiengesellschaft, Munich (DE)**

(72) Inventor: **Julien Thibaut Thomas Sarreméjean,  
Munich (DE)**

(73) Assignee: **Bayerische Motoren Werke  
Aktiengesellschaft, Munich (DE)**

(\*\*) Term: **15 Years**

(21) Appl. No.: **29/630,701**

(22) Filed: **Dec. 22, 2017**

(30) **Foreign Application Priority Data**

Jun. 30, 2017 (DE) ..... 40 2017 100 780

(51) **LOC (11) CL.** ..... **12-16**

(52) **U.S. CL.**  
USPC ..... **D12/184**

(58) **Field of Classification Search**  
USPC ..... D12/114, 181, 184; D15/28  
CPC ..... B62D 25/16; B62D 25/18  
See application file for complete search history.

(56) **References Cited**

**U.S. PATENT DOCUMENTS**

D511,486 S	11/2005	Nagashima	
D665,319 S	8/2012	Huet	
D686,552 S	7/2013	Weil	
9,278,716 B1 *	3/2016	Joseph	B62D 25/18
D756,870 S *	5/2016	Tsutamori	D12/184
D758,935 S *	6/2016	Platto	D12/184
D762,151 S	7/2016	Luk	
9,403,557 B1 *	8/2016	Sharma	C21D 1/06
9,487,238 B2 *	11/2016	Iwano	B62D 25/025
D775,031 S *	12/2016	Frascella	D12/184
D787,395 S *	5/2017	Curic	D12/181

9,669,876 B2 *	6/2017	Iwano	B62D 25/04
9,738,322 B2 *	8/2017	Matthiessen	B62D 25/02
D803,119 S *	11/2017	Beermann	D12/184
D803,741 S *	11/2017	Tsubaki	D12/184
D805,013 S *	12/2017	Whitla	D12/181

(Continued)

**FOREIGN PATENT DOCUMENTS**

EM	004521342-0001	11/2017
WO	WO DM/065775	11/2004

(Continued)

*Primary Examiner*— Susan Bennett Hattan

*Assistant Examiner*— Suzanne E Tisdell

(74) *Attorney, Agent, or Firm*— Crowell & Moring LLP

(57) **CLAIM**

The ornamental design for a front fender for a vehicle, as shown and described.

**DESCRIPTION**

This application contains subject matter related to the following co-pending U.S. design patent applications:

Application Ser. No. 29/594,687, filed Feb. 22, 2017 and entitled "Front Fender for a Vehicle";

Application Ser. No. 29/607,495, filed Jun. 14, 2017 and entitled "Front Fender for a Vehicle";

Application Ser. No. 29/630,692, filed herewith and entitled "Vehicle, Toy, and/or Replicas Thereof"; and

Application Ser. No. 29/630,695, filed herewith and entitled "Vehicle, Toy, and/or Replicas Thereof".

FIG. 1 is a front view of a front fender for a vehicle according to the design;

FIG. 2 is a left, front perspective view thereof;

FIG. 3 is a right, front perspective view thereof;

FIG. 4 is a left side view thereof;

FIG. 5 is a right side view thereof;

FIG. 6 is a top view thereof;

FIG. 7 is a bottom view thereof; and,

FIG. 8 is a rear view thereof.

**1 Claim, 8 Drawing Sheets**

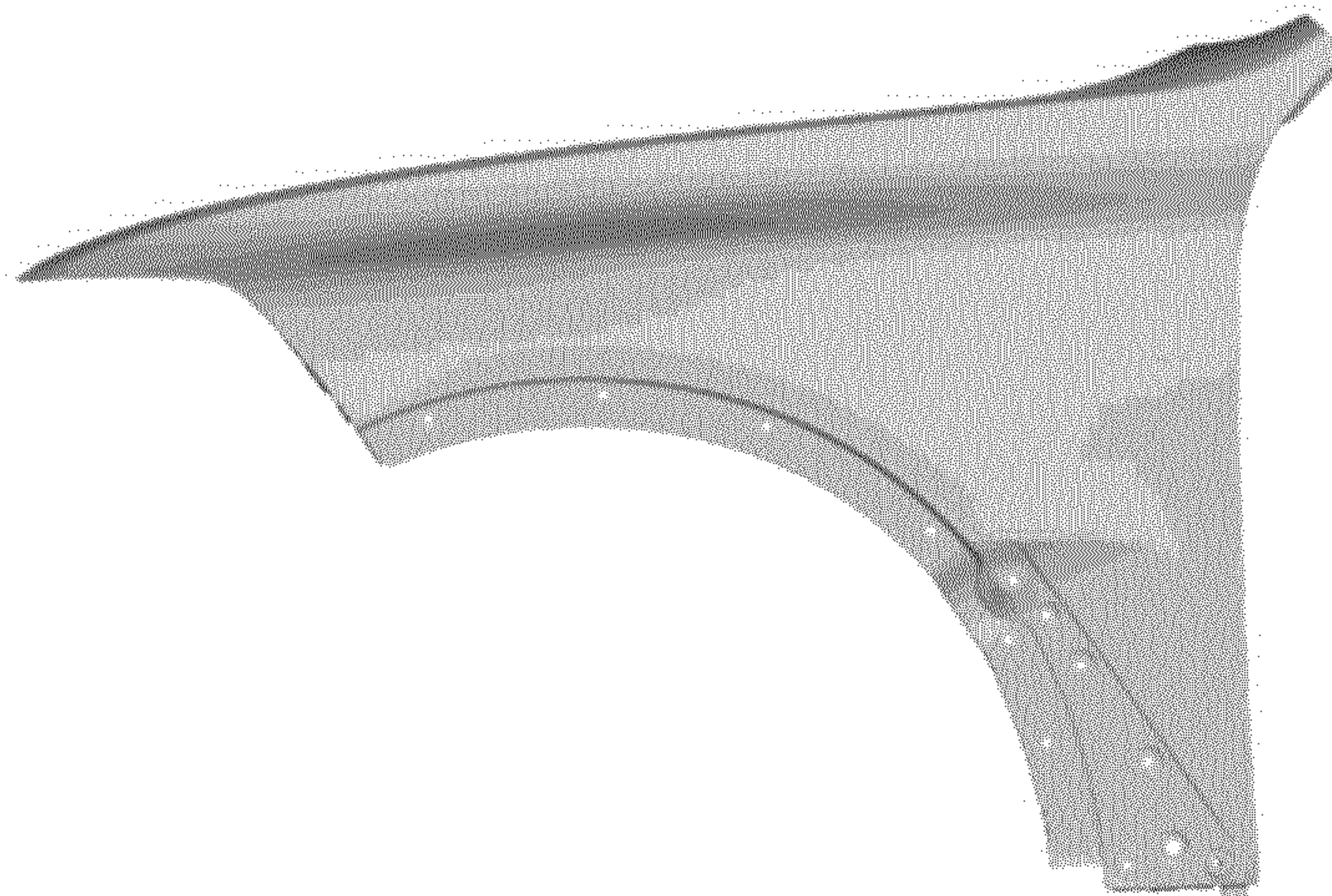



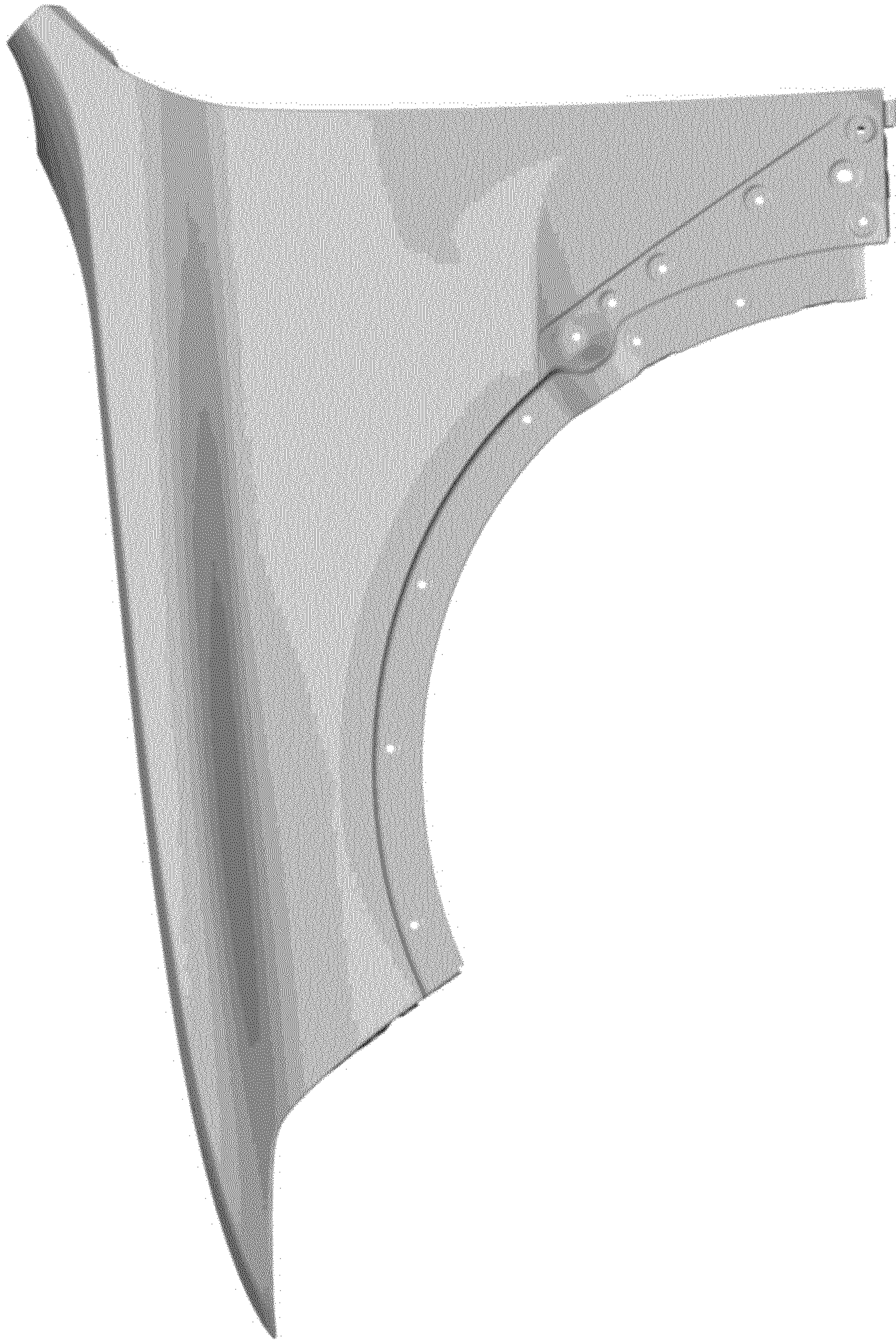

Fig. 1



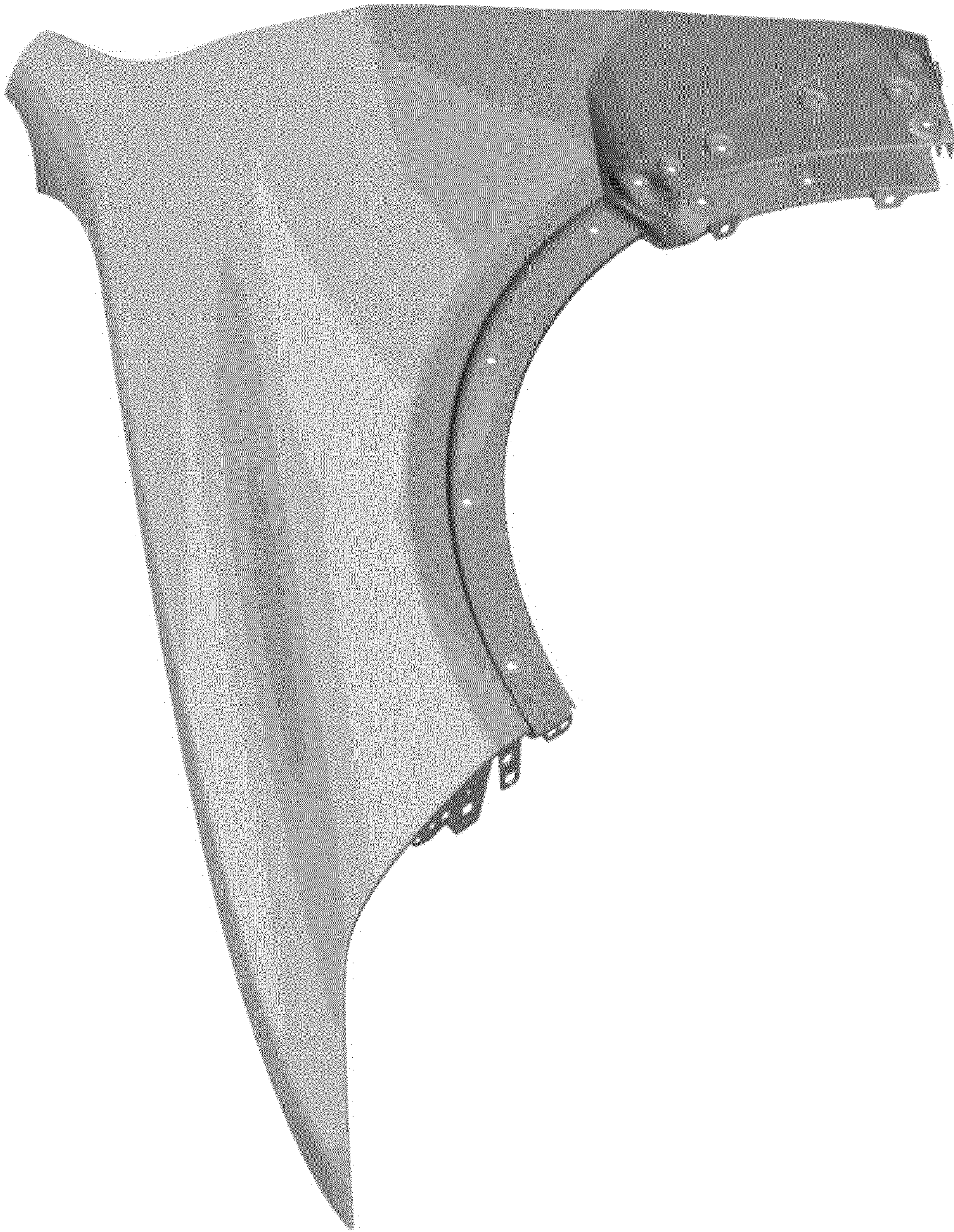

Fig. 2



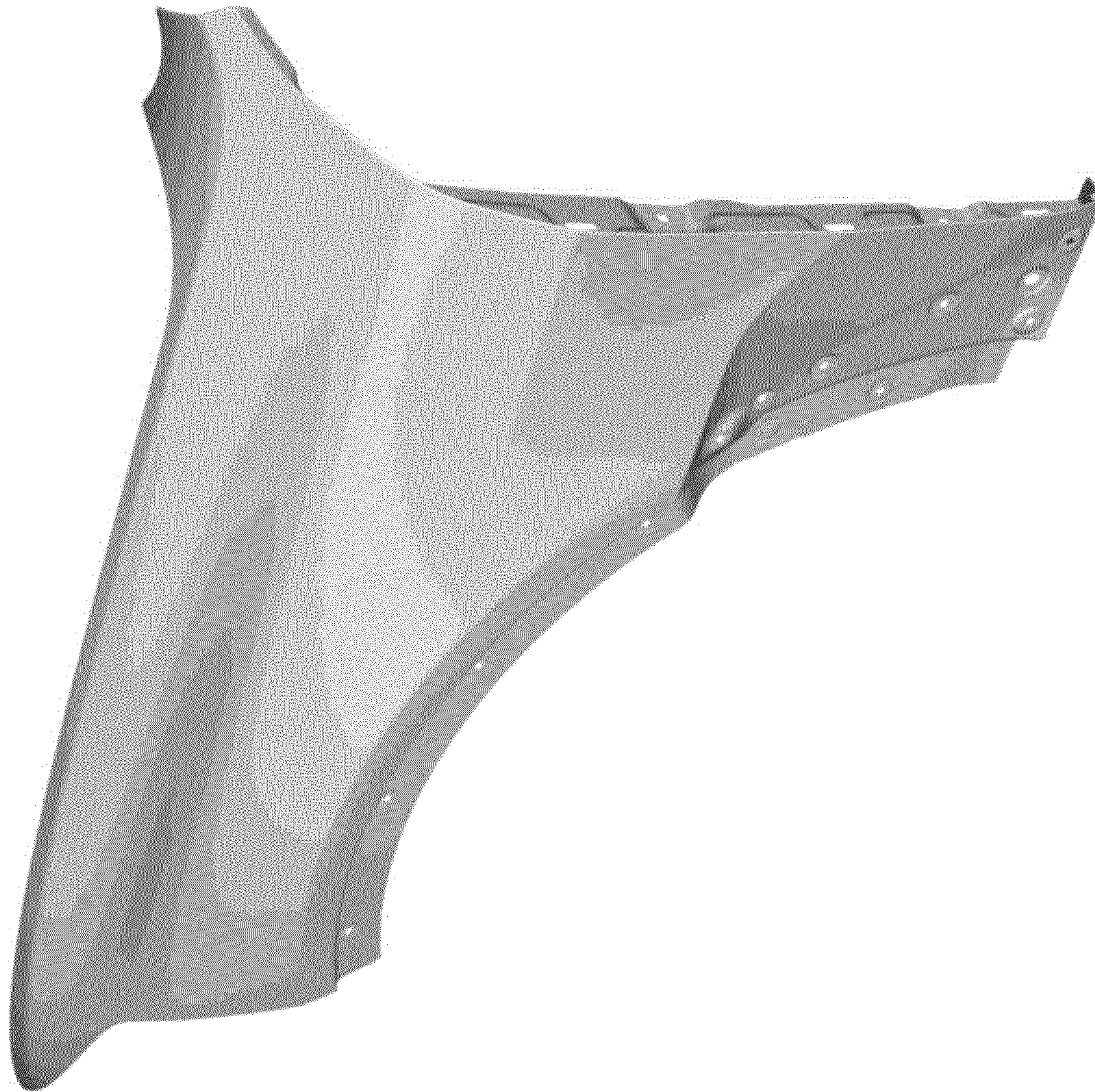

Fig. 3

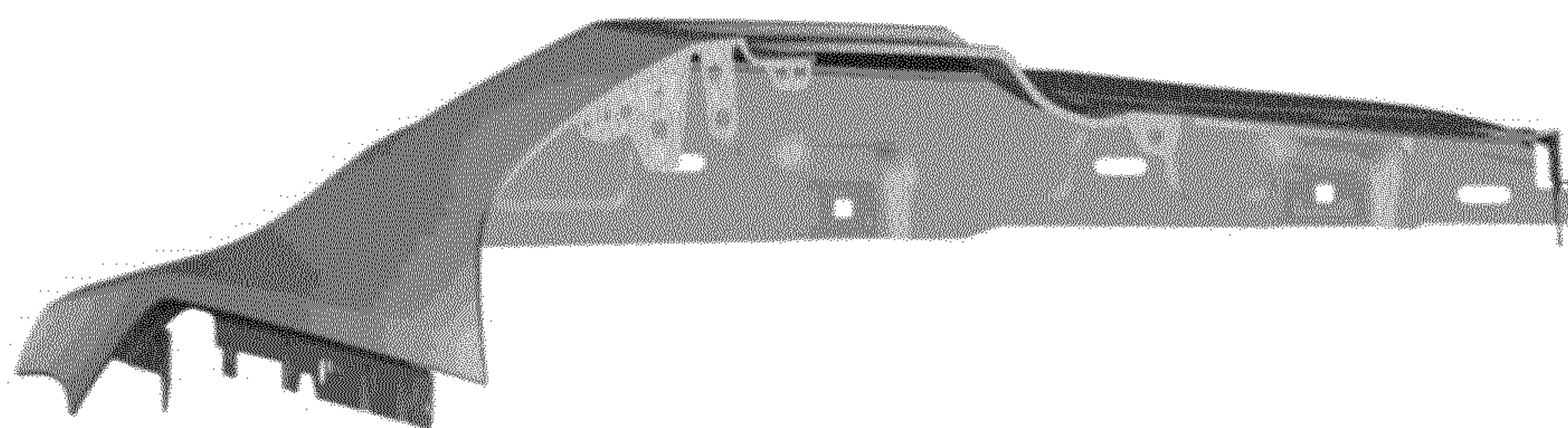

Fig. 4



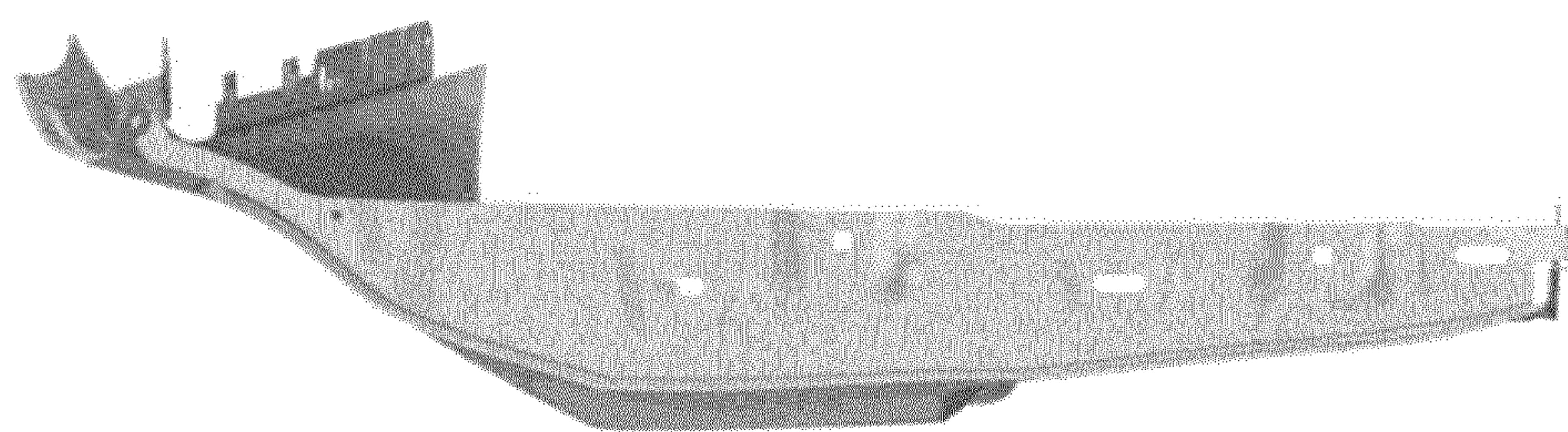

Fig. 5

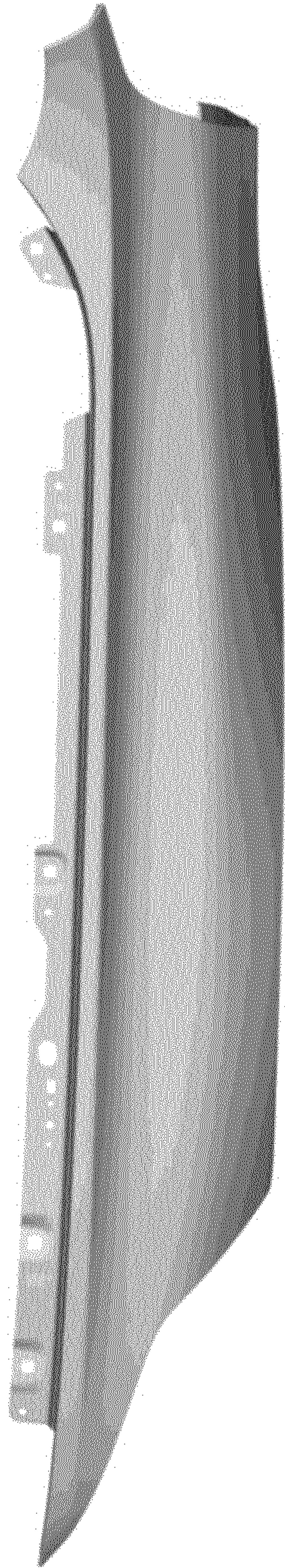

Fig. 6



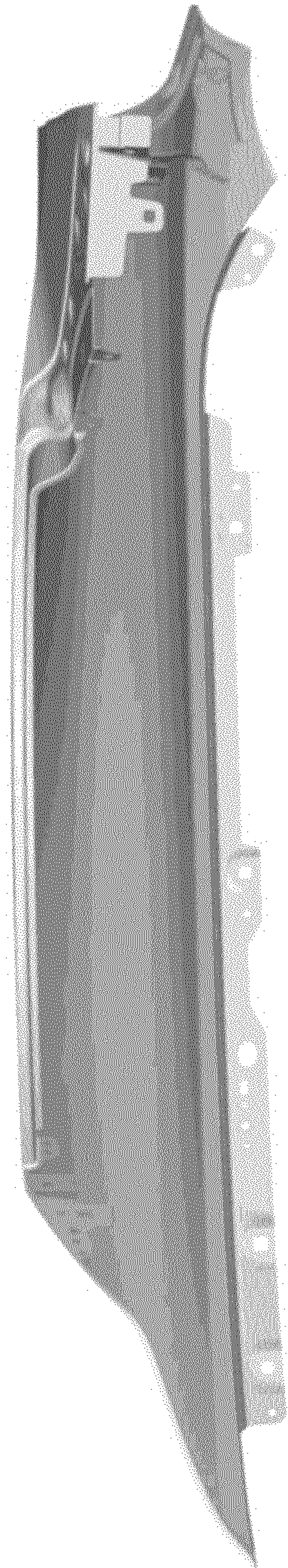

Fig. 7

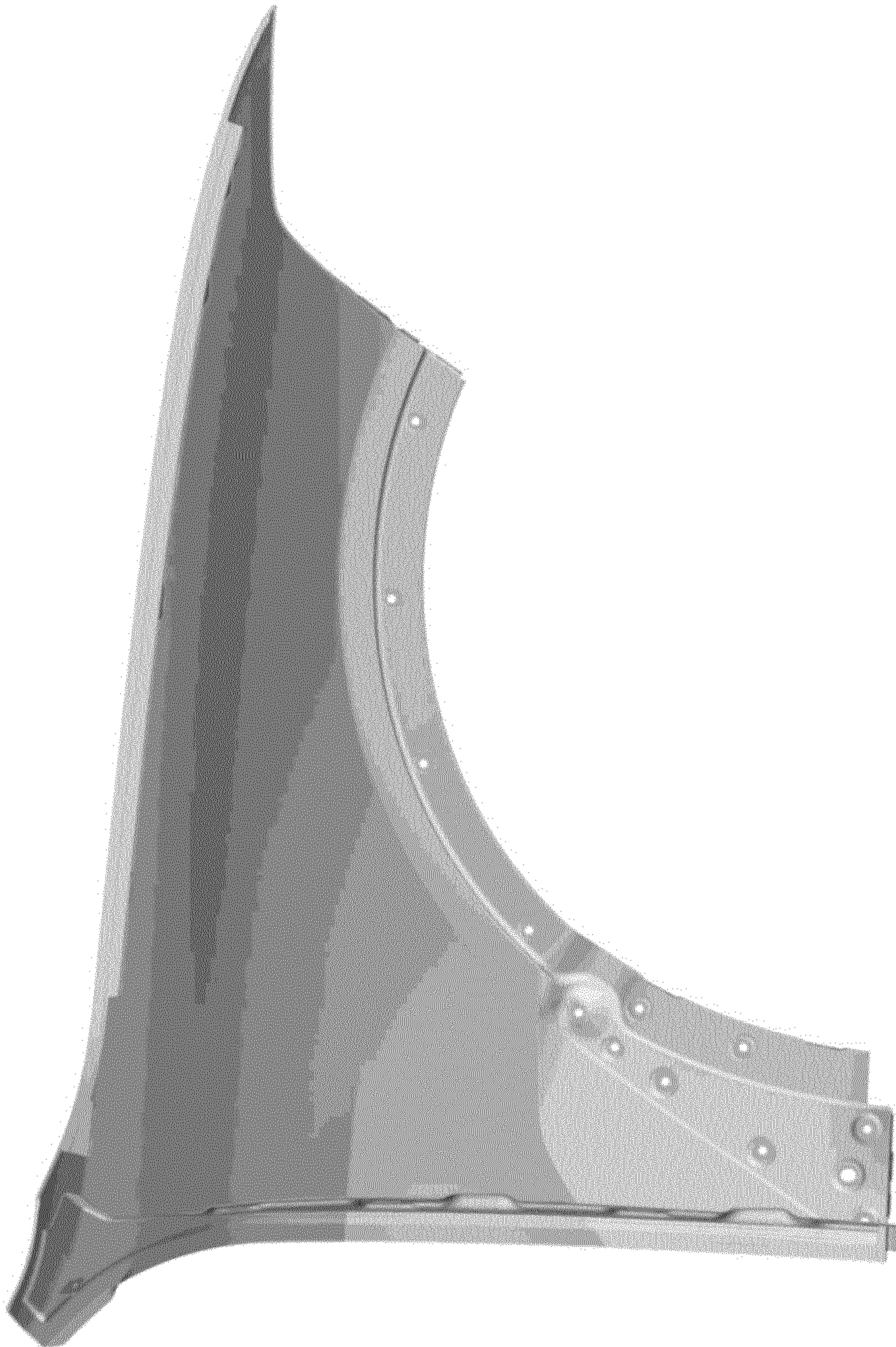

Fig. 8



UNITED STATES PATENT AND TRADEMARK OFFICE  
**CERTIFICATE OF CORRECTION**

PATENT NO. : D854,989 S  
APPLICATION NO. : 29/630701  
DATED : July 30, 2019  
INVENTOR(S) : Sarreméjean

Page 1 of 11

It is certified that error appears in the above-identified patent and that said Letters Patent is hereby corrected as shown below:

Delete in its entirety Pat. No. D854,989 S and insert in its entirety Pat. No. D854,989 S as shown on the attaches pages.

This certificate supersedes the Certificate of Correction issued December 31, 2019.

Signed and Sealed this  
Seventh Day of April, 2020

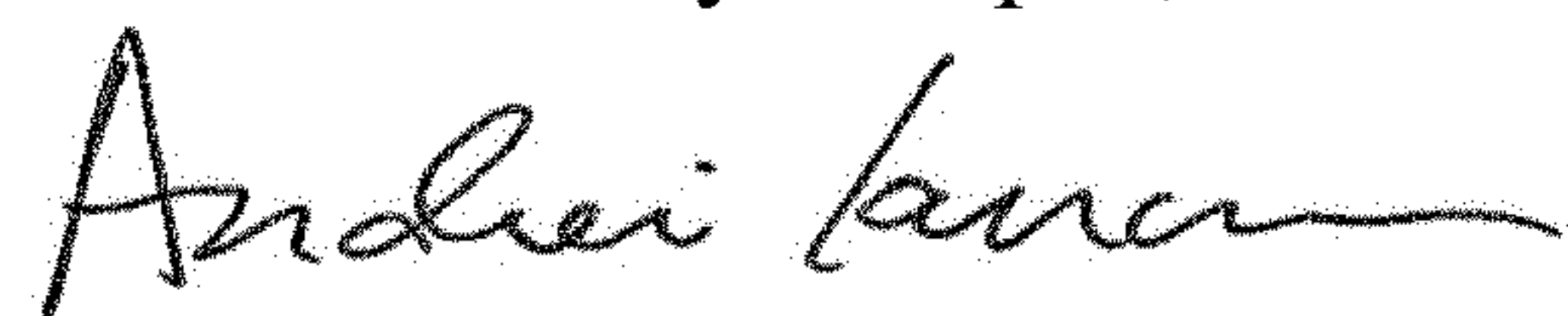

Andrei Iancu  
*Director of the United States Patent and Trademark Office*

(12) **United States Design Patent** (10) **Patent No.:** **US D854,989 S**  
**Sarreméjean** (45) **Date of Patent:** **\*\* Jul. 30, 2019**

(54) **FRONT FENDER FOR A VEHICLE**  
 (71) Applicant: **Bayerische Motoren Werke Aktiengesellschaft, Munich (DE)**  
 (72) Inventor: **Julien Thibaut Thomas Sarreméjean, Munich (DE)**

9,669,876 B2 \* 6/2017 Iwano ..... B62D 25/04  
 9,738,322 B2 \* 8/2017 Matthiessen ..... B62D 25/02  
 D803,119 S \* 11/2017 Beermann ..... D12/184  
 D803,741 S \* 11/2017 Tsubaki ..... D12/184  
 D805,013 S \* 12/2017 Whitla ..... D12/181

(Continued)

**FOREIGN PATENT DOCUMENTS**

(73) Assignee: **Bayerische Motoren Werke Aktiengesellschaft, Munich (DE)**

EM 004521342-0001 11/2017  
 WO WO DM/065775 11/2004

(Continued)

(\*\*) Term: **15 Years**

*Primary Examiner* — Susan Bennett Hattan

*Assistant Examiner* — Suzanne E Tisdell

(21) Appl. No.: **29/630,701**

(74) *Attorney, Agent, or Firm* — Crowell & Moring LLP

(22) Filed: **Dec. 22, 2017**

(57) **CLAIM**

(30) **Foreign Application Priority Data**

The ornamental design for a front fender for a vehicle, as shown and described.

Jun. 30, 2017 (DE) ..... 40 2017 100 780

**DESCRIPTION**

(51) **LOC (12) Cl.** ..... **12-16**

(52) **U.S. Cl.**

USPC ..... **D12/184**

(58) **Field of Classification Search**

USPC ..... D12/114, 181, 184; D15/28

CPC ..... B62D 25/16; B62D 25/18

See application file for complete search history.

This application contains subject matter related to the following co-pending U.S. design patent applications:

Application Ser. No. 29/594,687, filed Feb. 22, 2017 and entitled "Front Fender for a Vehicle";

Application Ser. No. 29/607,495, filed Jun. 14, 2017 and entitled "Front Fender for a Vehicle";

Application Ser. No. 29/630,692, filed herewith and entitled "Vehicle, Toy, and/or Replicas Thereof"; and

Application Ser. No. 29/630,695, filed herewith and entitled "Vehicle, Toy, and/or Replicas Thereof".

FIG. 1 is a front view of a front fender for a vehicle according to the design;

FIG. 2 is a left, front perspective view thereof;

FIG. 3 is a right, front perspective view thereof;

FIG. 4 is a left side view thereof;

FIG. 5 is a right side view thereof;

FIG. 6 is a top view thereof;

FIG. 7 is a bottom view thereof; and,

FIG. 8 is a rear view thereof.

(56) **References Cited**

**U.S. PATENT DOCUMENTS**

D511,486 S 11/2005 Nagashima  
 D665,319 S 8/2012 Huet  
 D686,552 S 7/2013 Weil  
 9,278,716 B1 \* 3/2016 Joseph ..... B62D 25/18  
 D756,870 S \* 5/2016 Tsutamori ..... D12/184  
 D758,935 S \* 6/2016 Platto ..... D12/184  
 D762,151 S 7/2016 Luk  
 9,403,557 B1 \* 8/2016 Sharma ..... C21D 1/06  
 9,487,238 B2 \* 11/2016 Iwano ..... B62D 25/025  
 D775,031 S \* 12/2016 Frascella ..... D12/184  
 D787,395 S \* 5/2017 Curic ..... D12/181

**1 Claim, 8 Drawing Sheets**

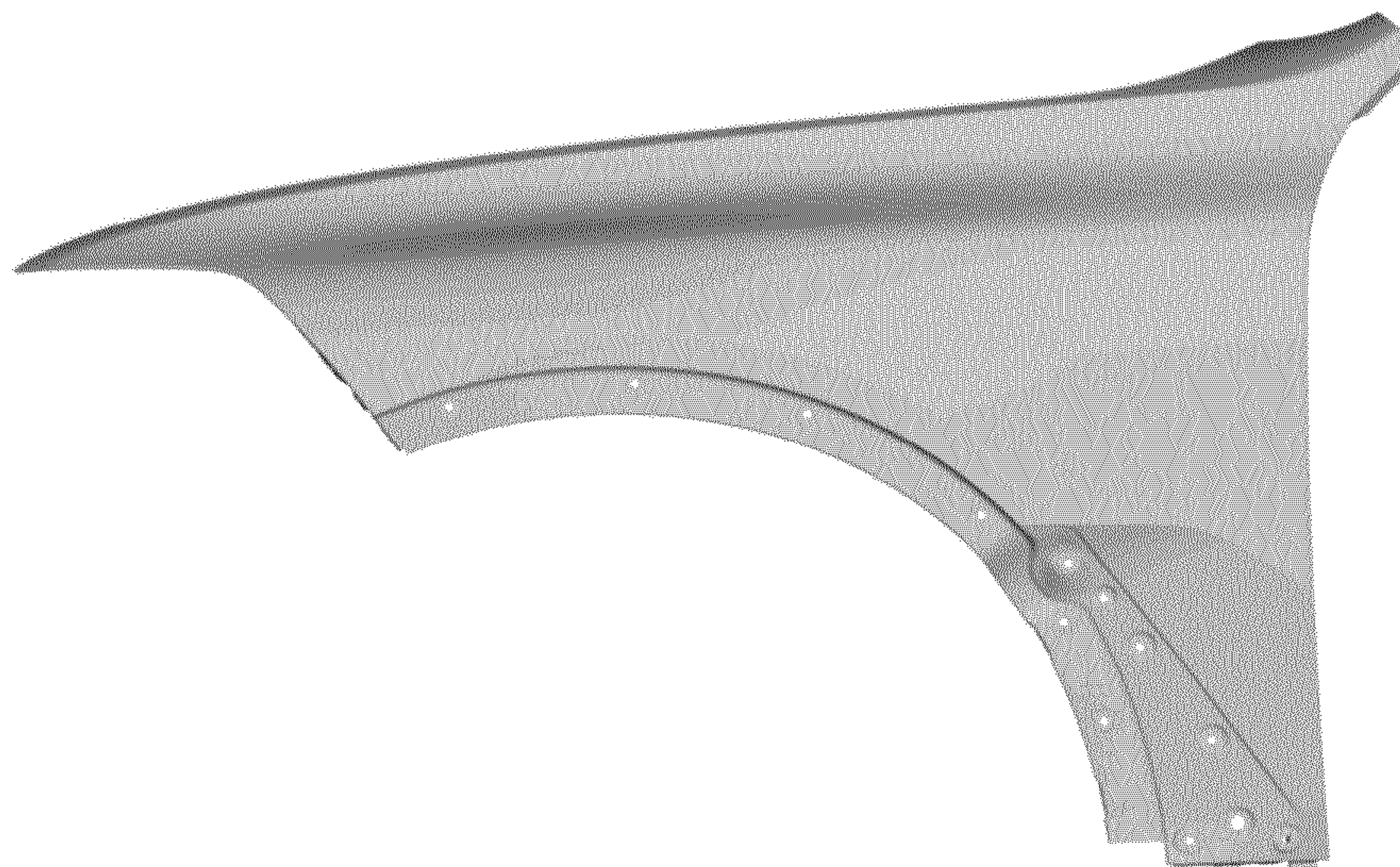



US D854,989 S

Page 2

(56) References Cited

U.S. PATENT DOCUMENTS

D806,622	S *	1/2018	Granlund .....	D12/184
D807,261	S *	1/2018	Zavatski .....	D12/184
9,890,966	B2 *	2/2018	Mueller .....	B62D 25/16
D817,829	S *	5/2018	Behmer .....	D12/184
D820,751	S *	6/2018	Luk .....	D12/184
D823,741	S *	7/2018	Kim .....	D12/169
10,023,241	B2 *	7/2018	Umemoto .....	B62D 25/161
10,035,543	B2 *	7/2018	Sato .....	B60J 5/0444
D826,811	S *	8/2018	Lim .....	D12/184
D827,527	S *	9/2018	Loeb .....	D12/184
D827,528	S *	9/2018	Gueler .....	D12/184
D827,529	S *	9/2018	Al Attar .....	D12/184
D828,254	S *	9/2018	Simm .....	D12/184
10,077,085	B2 *	9/2018	Pfaffelhuber .....	B62D 27/02

FOREIGN PATENT DOCUMENTS

WO	WO DM/074951	5/2011
WO	WO DM/076560	2/2012
WO	WO DM/094978	8/2017
WO	WO DM/096612	12/2017

\* cited by examiner

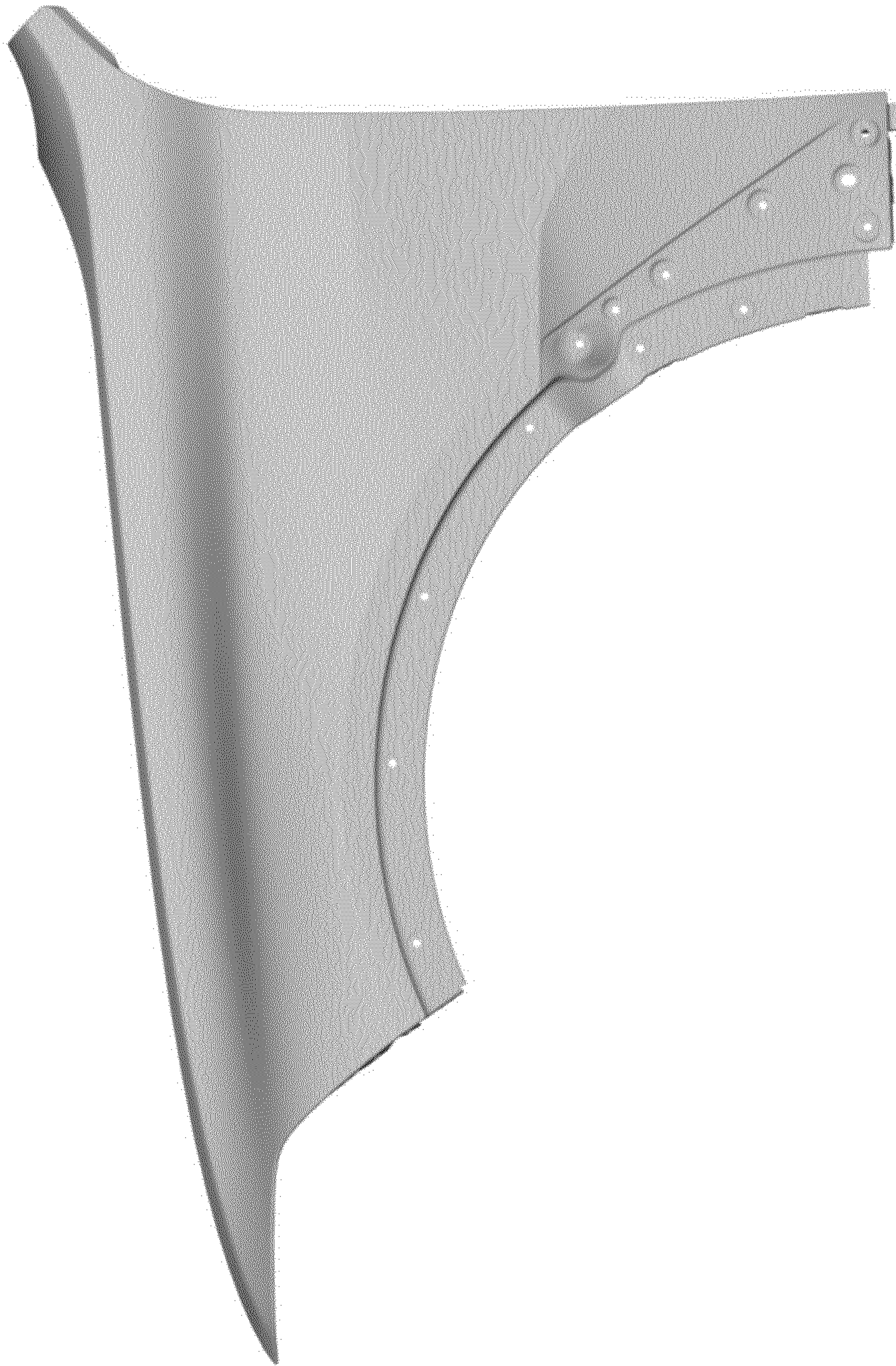

Fig. 1



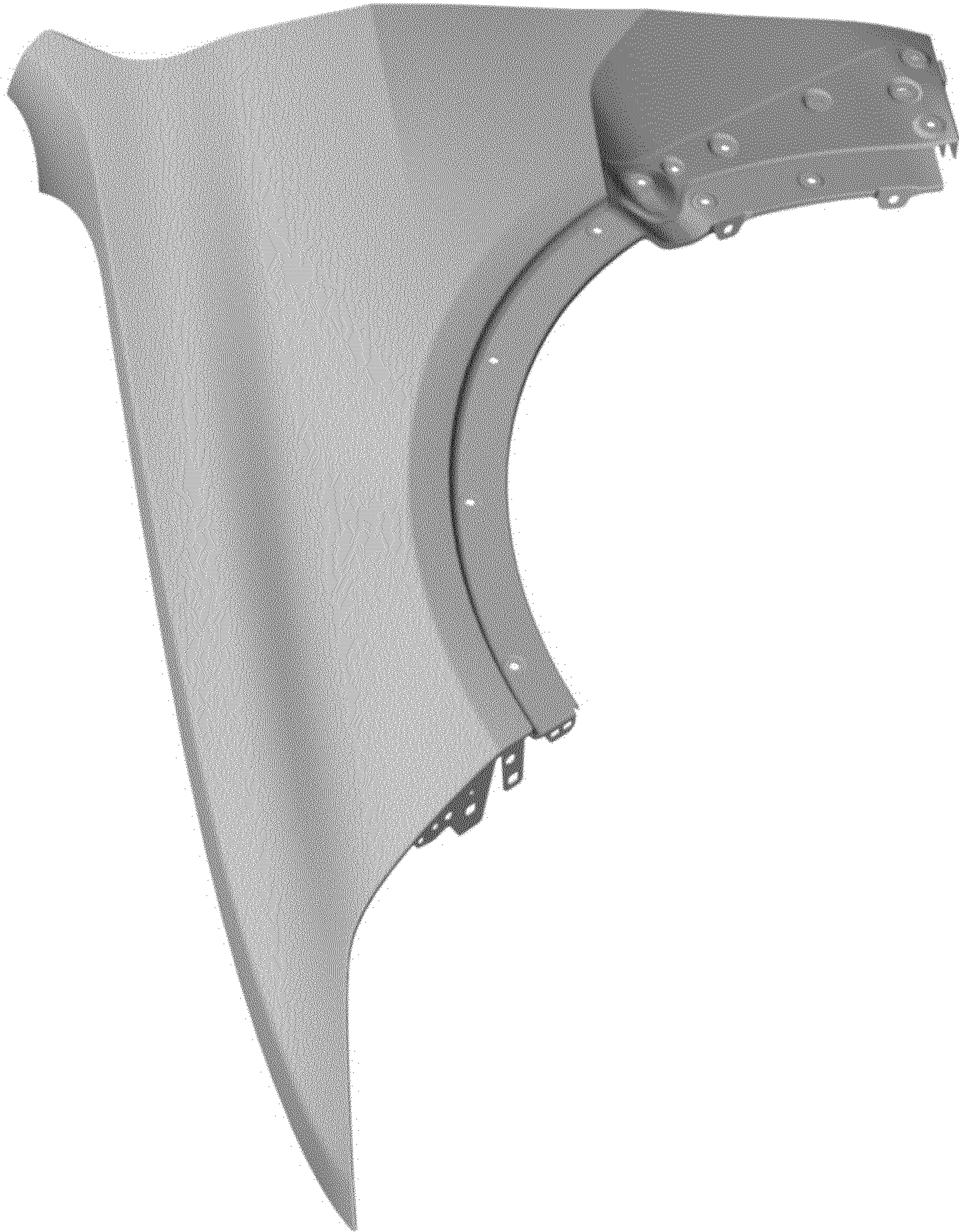

Fig. 2



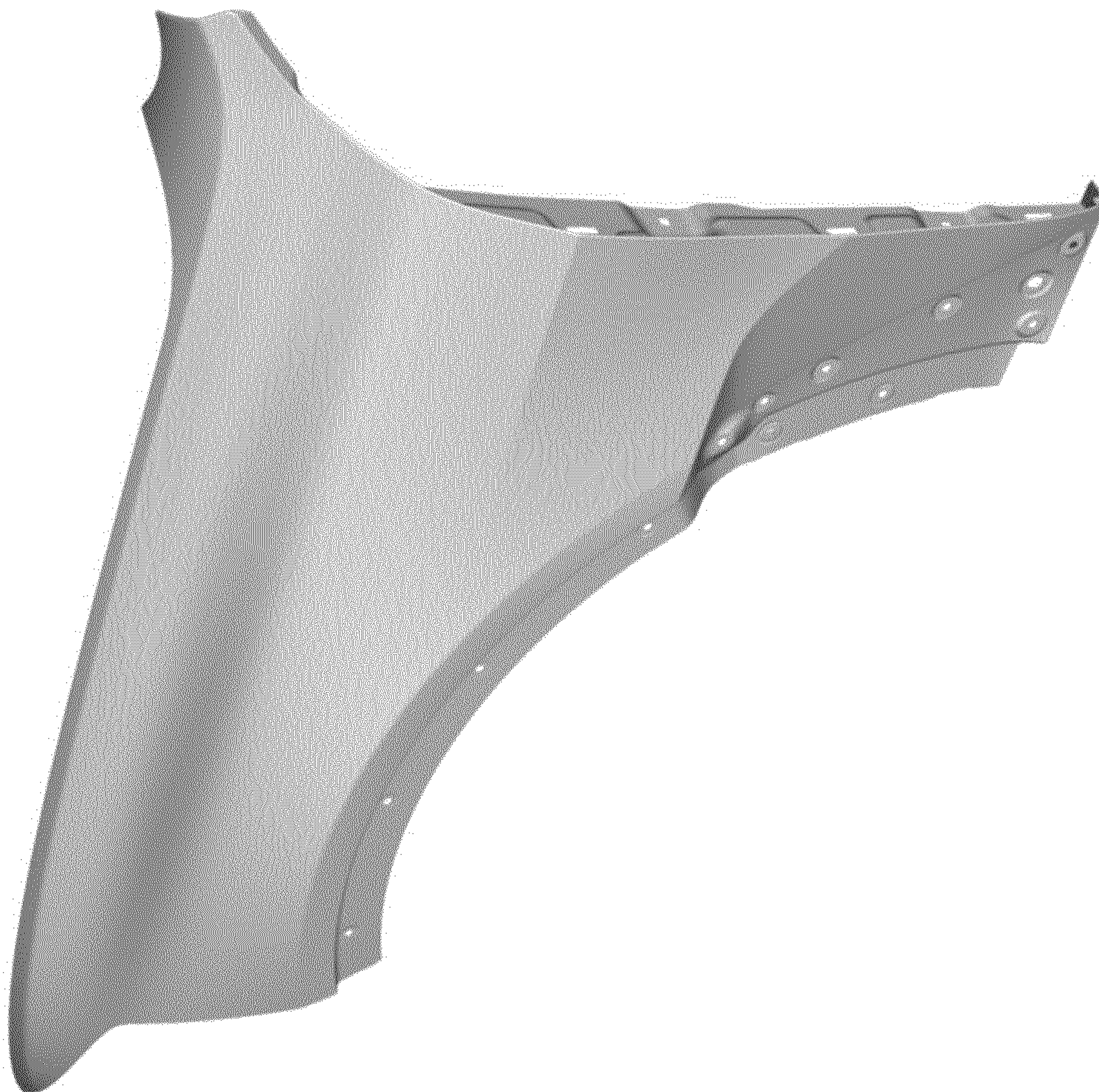

Fig. 3



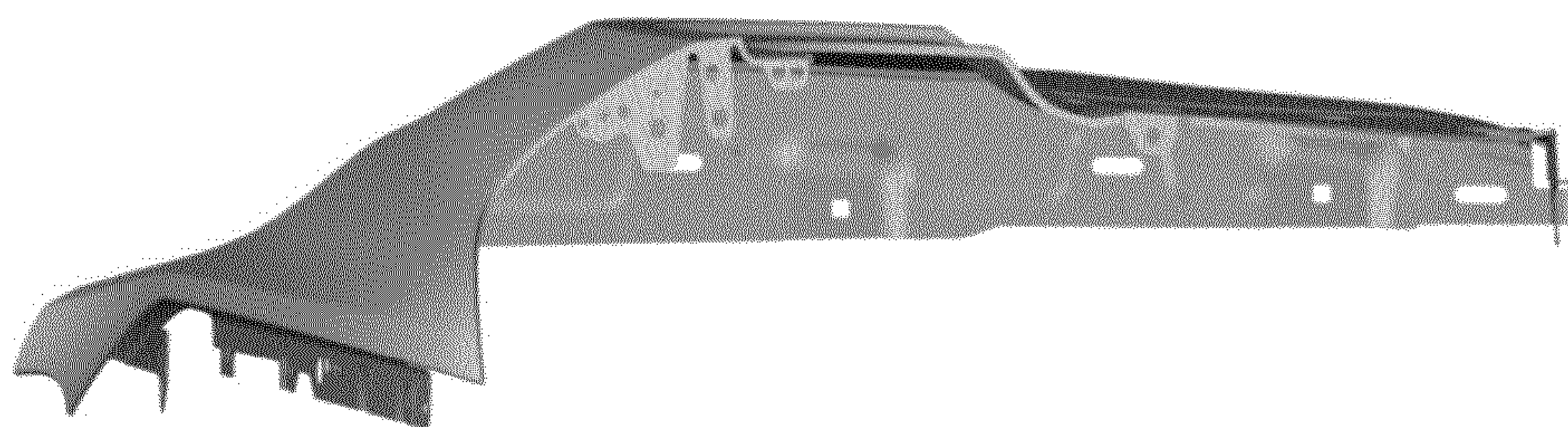

Fig. 4

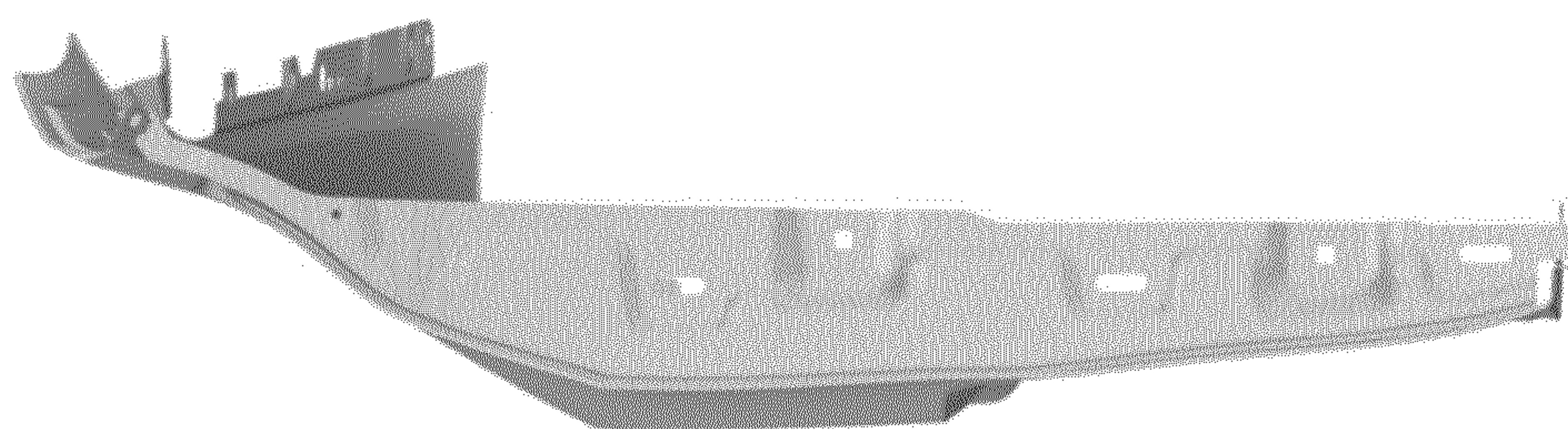

Fig. 5



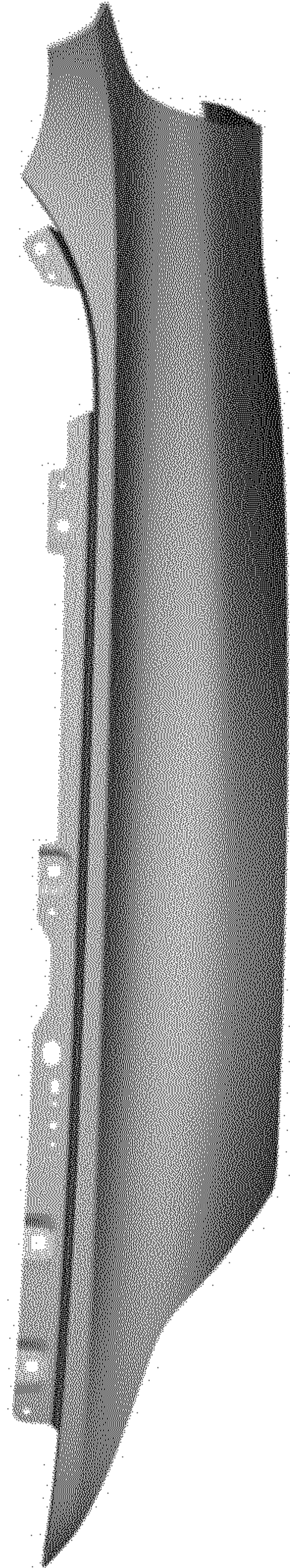

Fig. 6

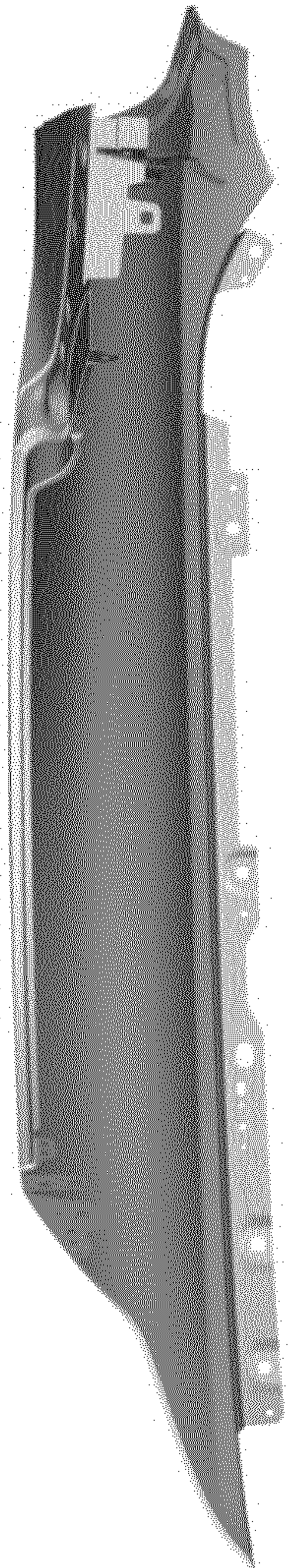

Fig. 7



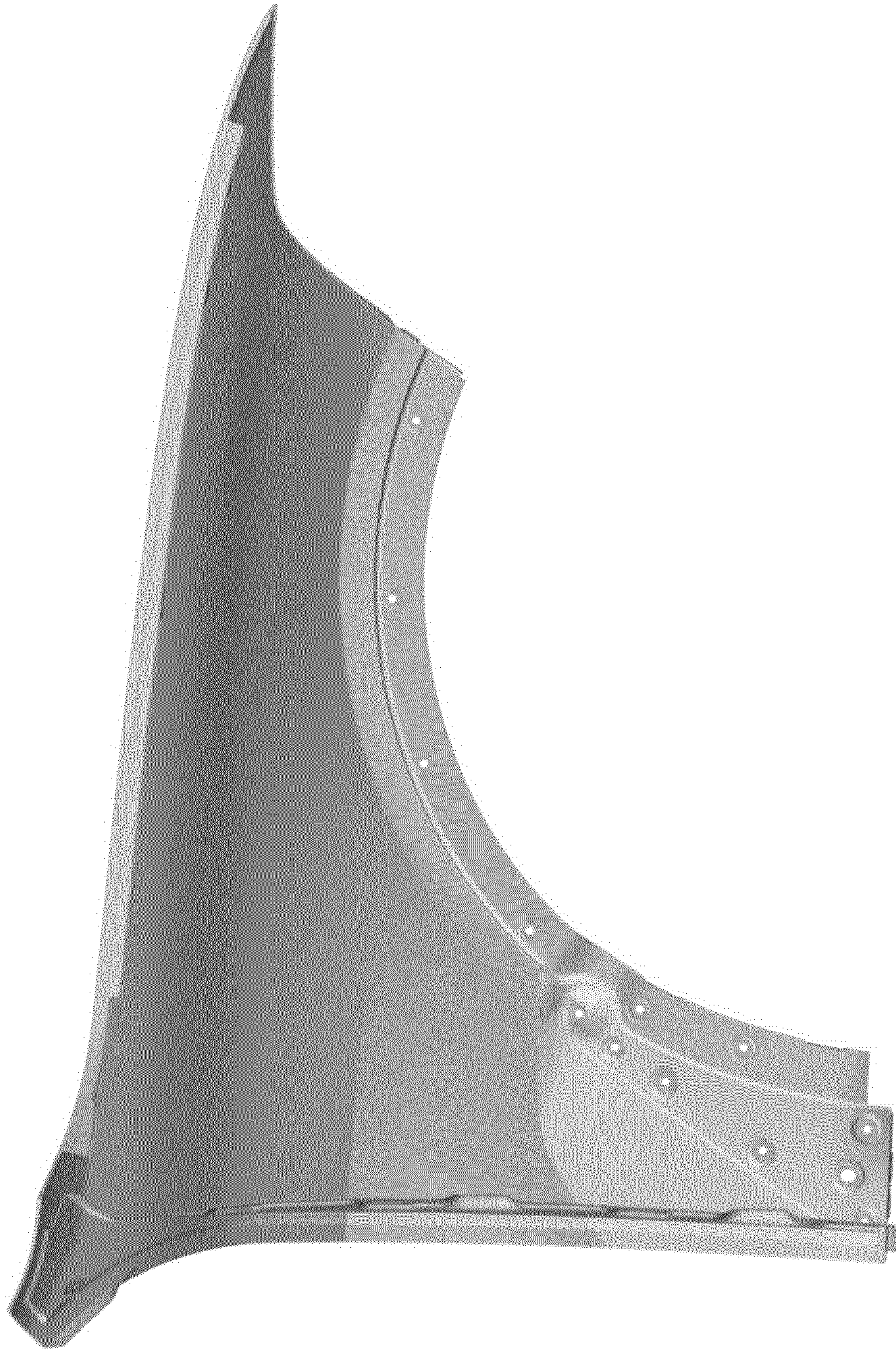

Fig. 8