



US00D854932S

(12) **United States Design Patent** (10) **Patent No.:** **US D854,932 S**
Amano (45) **Date of Patent:** **** Jul. 30, 2019**

(54) **PACKAGING FOR COSMETIC PRODUCTS**

(56) **References Cited**

(71) Applicant: **FEARLESS INC.**, Tokyo (JP)

U.S. PATENT DOCUMENTS

(72) Inventor: **Yoshihiro Amano**, Tokyo (JP)

D320,550 S *	10/1991	Arturo	D9/435
D336,036 S *	6/1993	Wacker	D9/544
D387,989 S *	12/1997	Chahed	D9/516
D545,200 S *	6/2007	Dosa	D9/451
D683,222 S *	5/2013	McGregor	D9/661
D753,838 S *	4/2016	Matsushita	D24/200

(**) Term: **15 Years**

* cited by examiner

(21) Appl. No.: **35/503,480**

(22) Filed: **Apr. 7, 2017**

Primary Examiner — Melanie H Tung

Assistant Examiner — Bao-Yen T Nguyen

(80) **Hague Agreement Data**

Int. Filing Date: **Apr. 7, 2017**

Int. Reg. No.: **DM/097047**

Int. Reg. Date: **Apr. 7, 2017**

Int. Reg. Pub. Date: **Aug. 11, 2017**

(57) **CLAIM**

The ornamental design for packaging for cosmetic products, as shown and described.

(51) **LOC (11) Cl.** **09-01**

(52) **U.S. Cl.**
USPC **D9/523**

(58) **Field of Classification Search**
 USPC D9/500–504, 682, 688, 689, 690, 691,
 D9/692, 516, 529, 549, 551, 559;
 D28/76, 77, 82, 91, 91.1
 CPC A45D 33/00; A45D 33/003; A45D 33/006;
 A45D 33/02; A45D 33/025; A45D 33/18;
 A45D 33/22; A45D 34/00; A45D
 2034/007; A45D 34/02; A45D 40/40;
 A45D 40/0068; A45D 40/0075; A45D
 2040/12; A45D 2200/05; A45D 2200/051;
 A45D 2200/052; A45D 2200/053

DESCRIPTION

1. Packaging for cosmetic products

1.1 : Perspective

1.2 : Perspective

1.3 : Front

1.4 : Back

1.5 : Left

1.6 : Right

1.7 : Top

1.8 : Bottom

1.9 : Cross-sectional

1.10 : Exploded

The article of the design is packaging for cosmetic cream or the like; the article comprises a container part and an exterior part which is provided in the periphery of the container part.

See application file for complete search history.

1 Claim, 10 Drawing Sheets

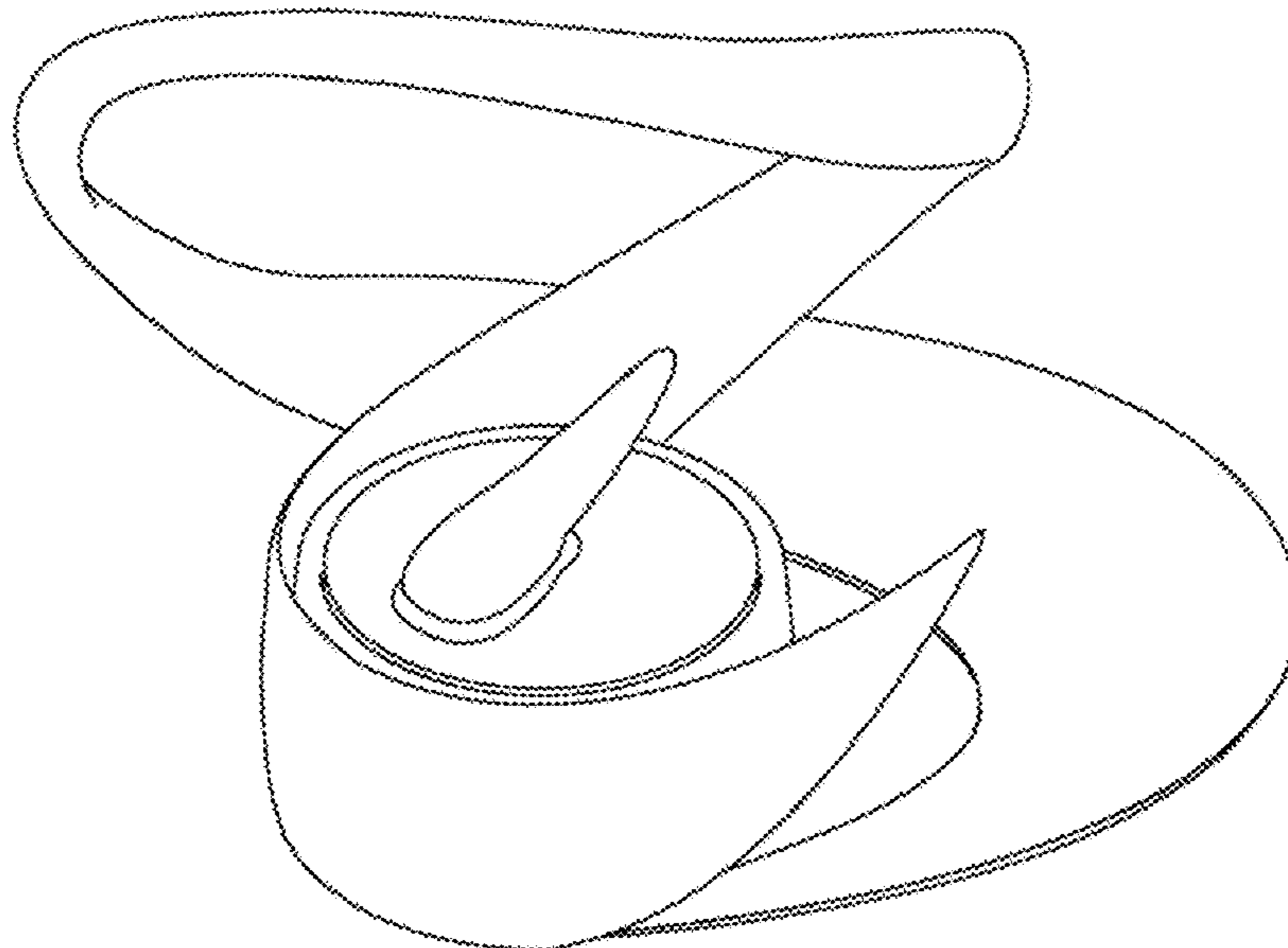

1.1

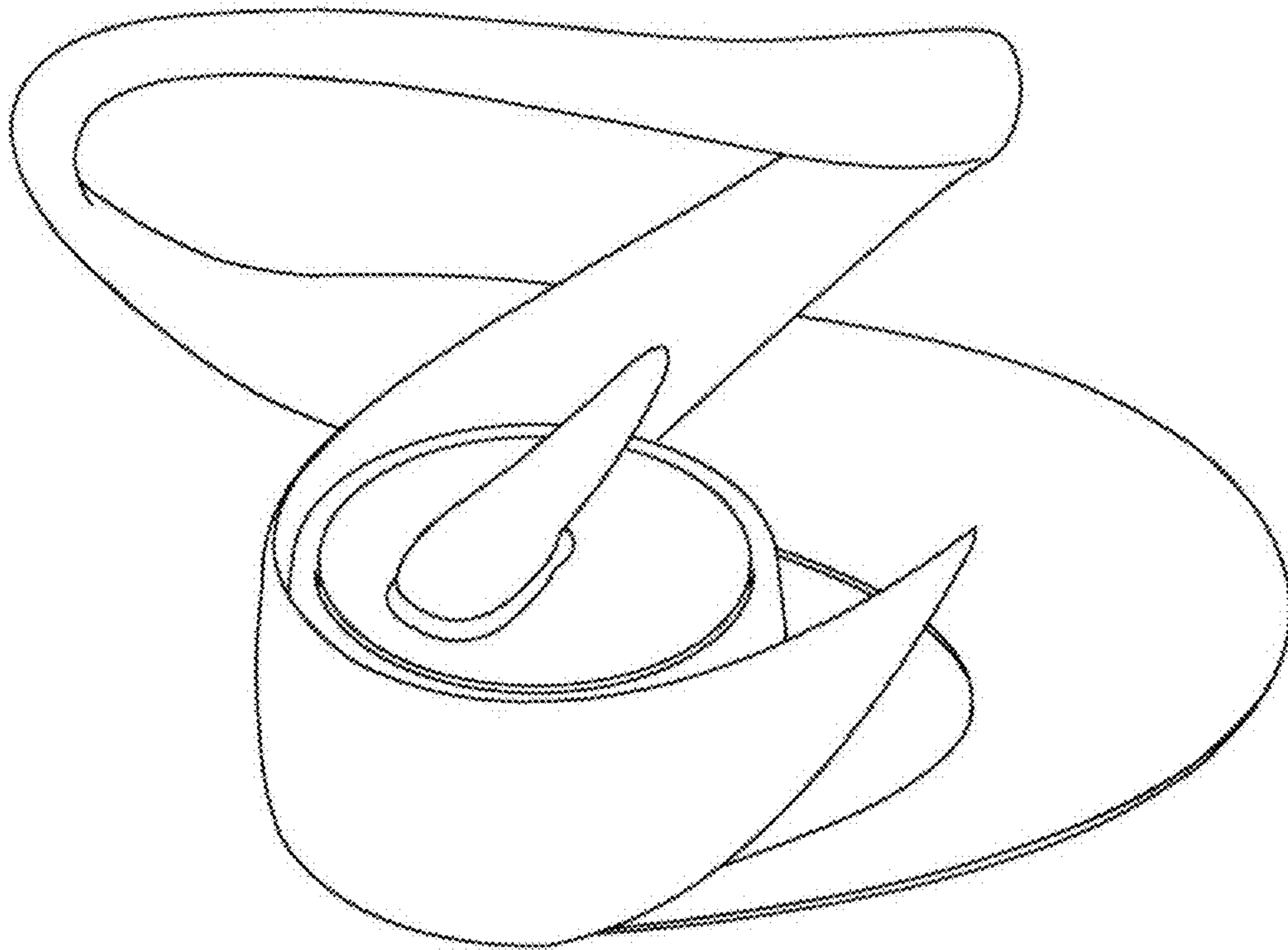

1.2

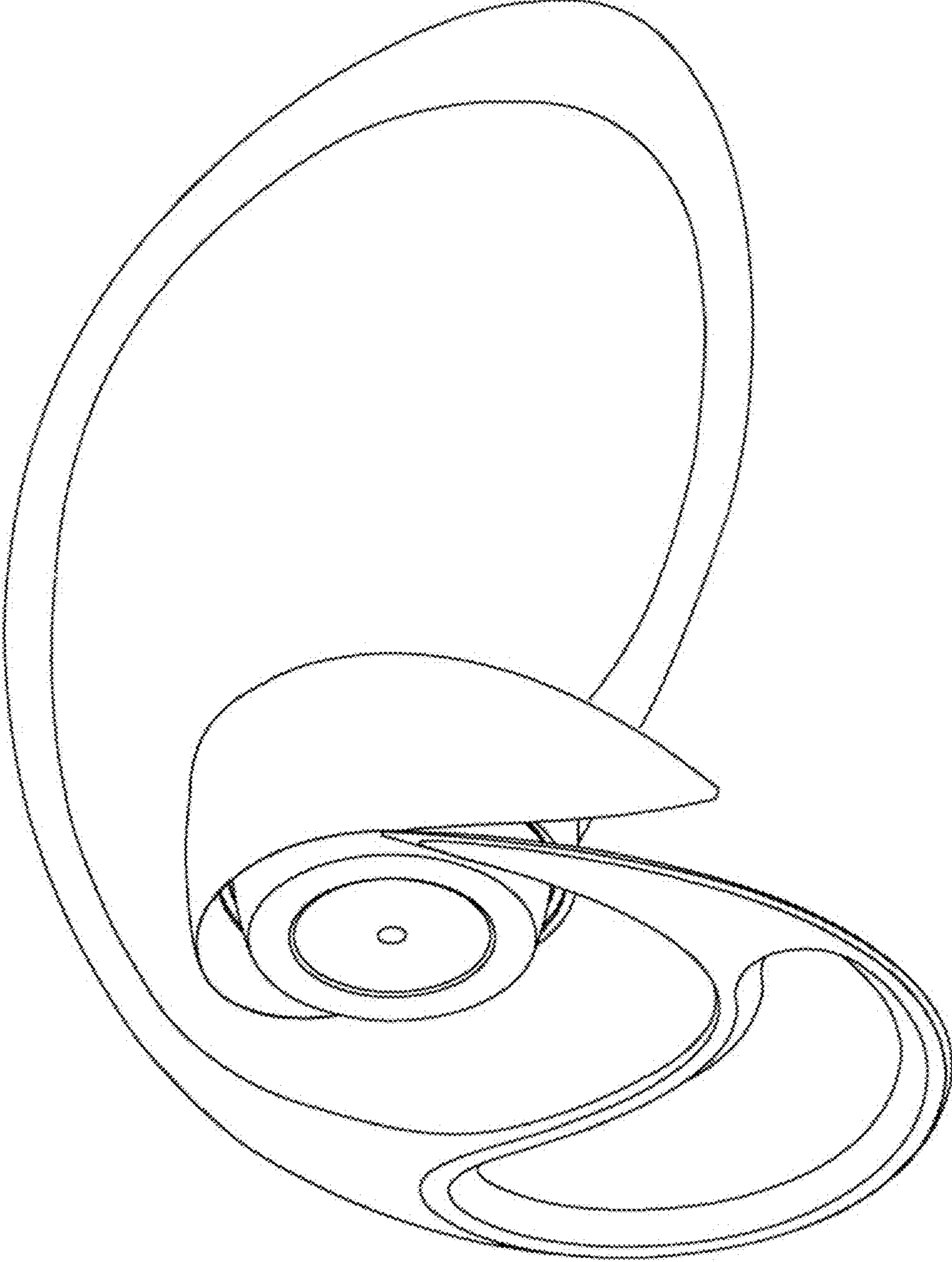

1.3

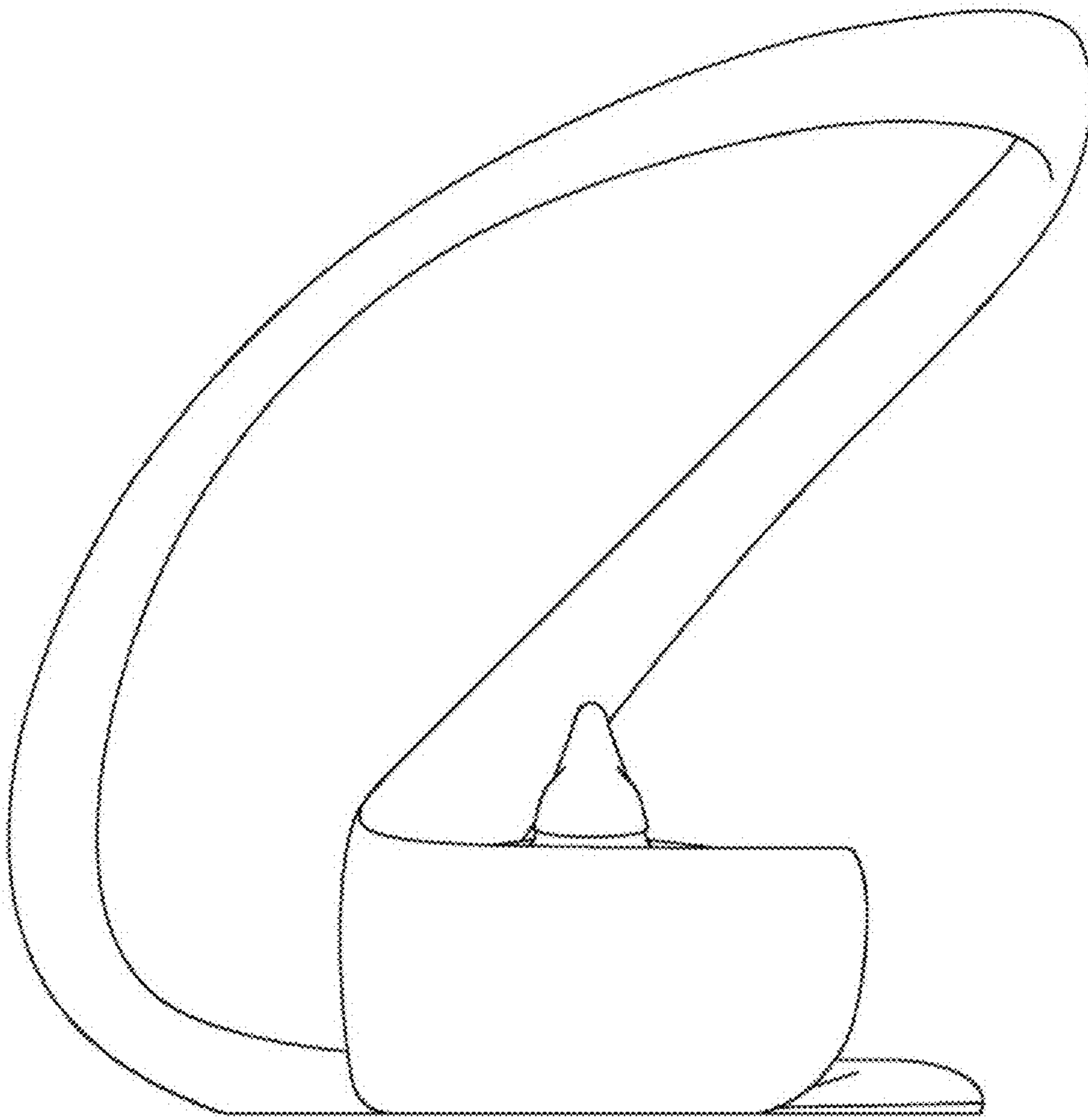

1.4

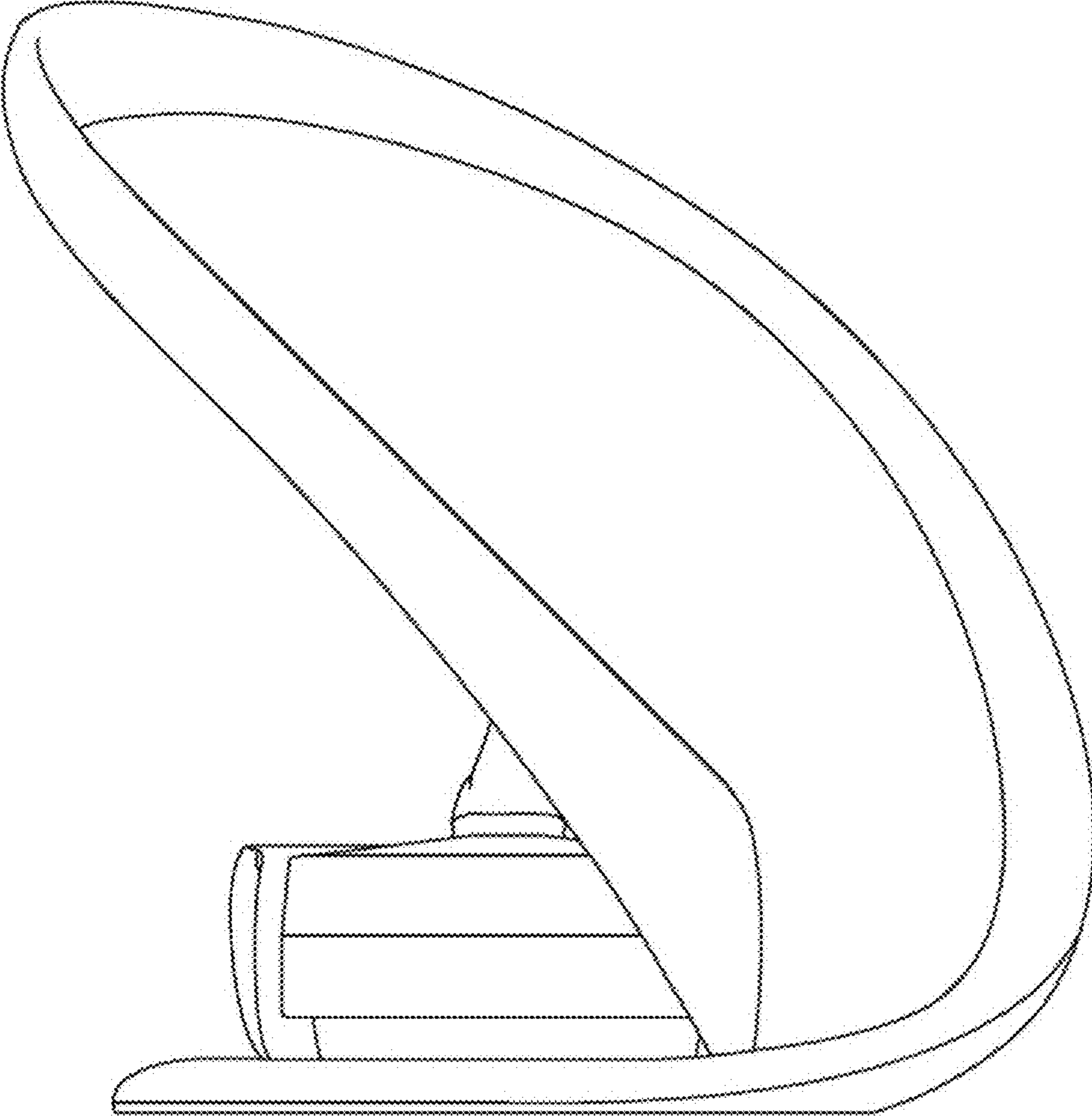

1.5

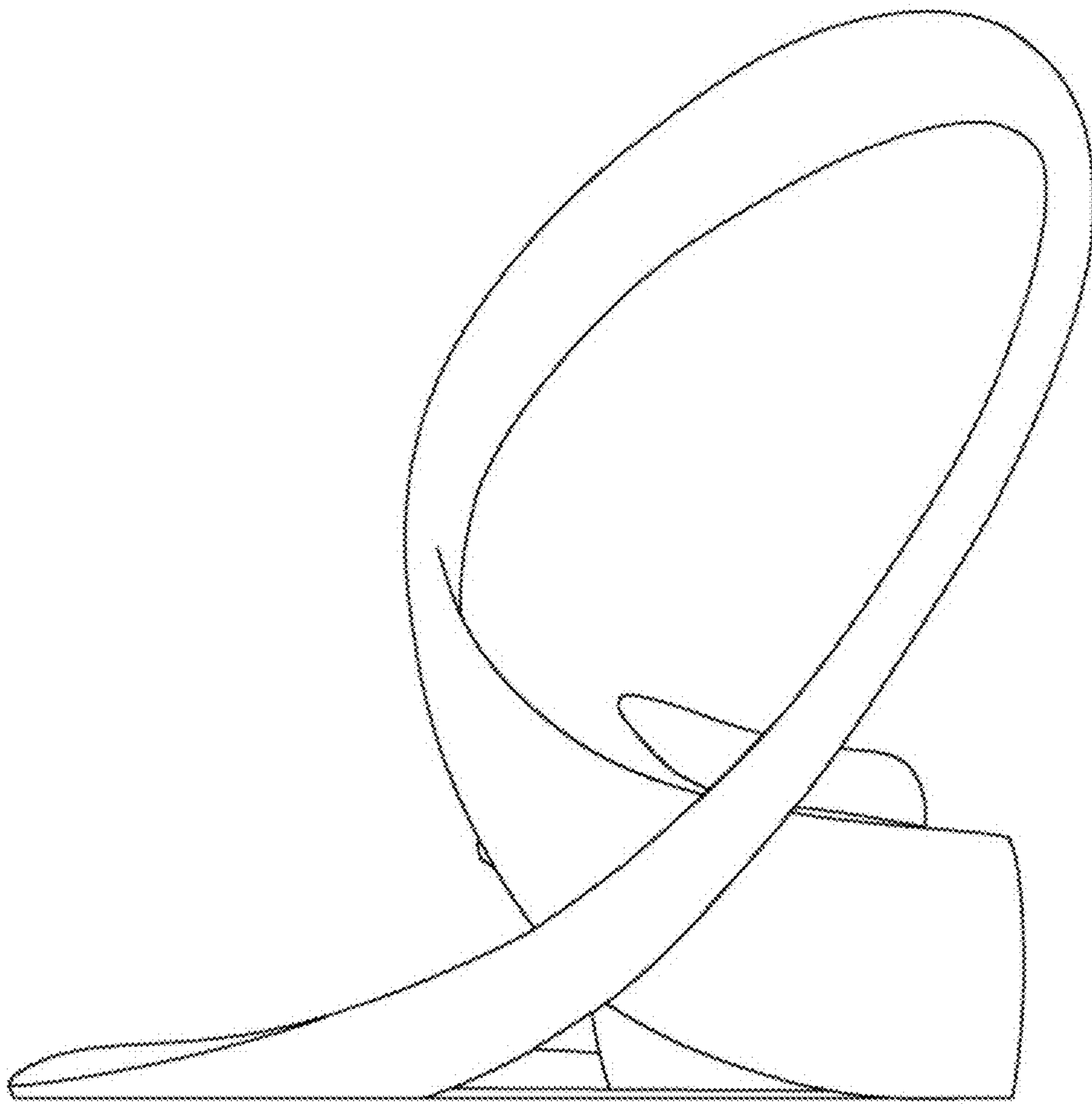

1.6

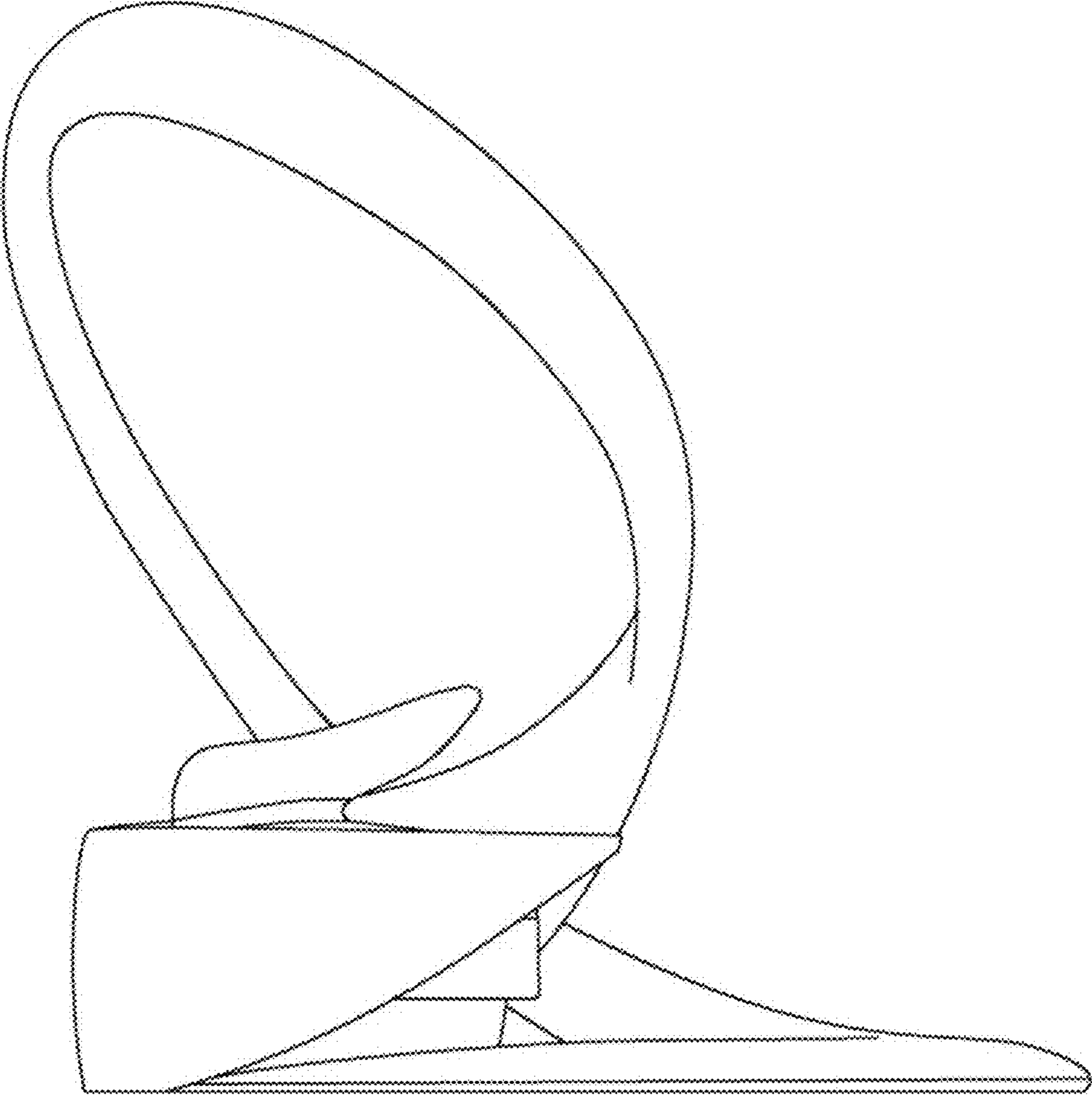

1.7

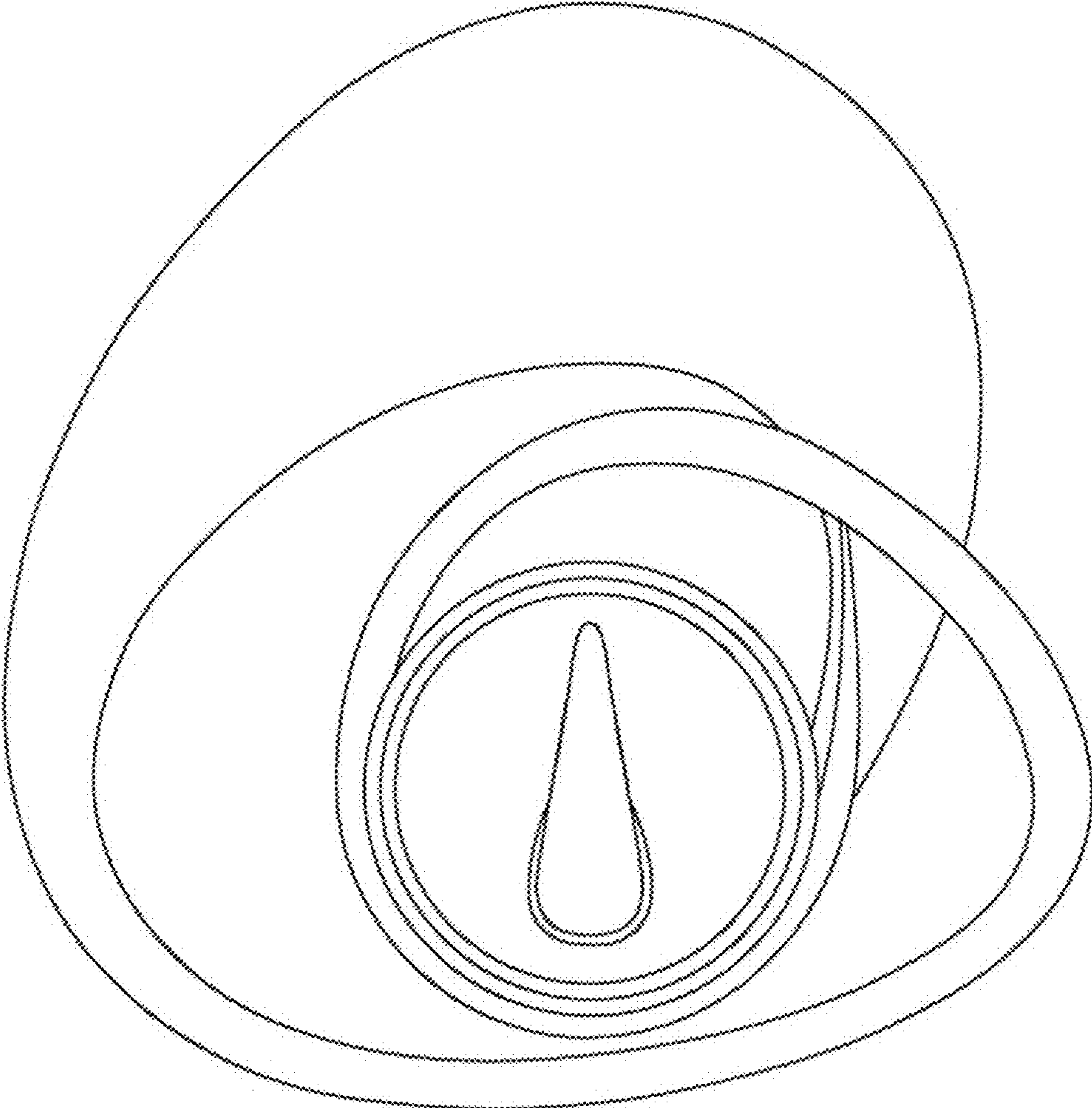

1.8

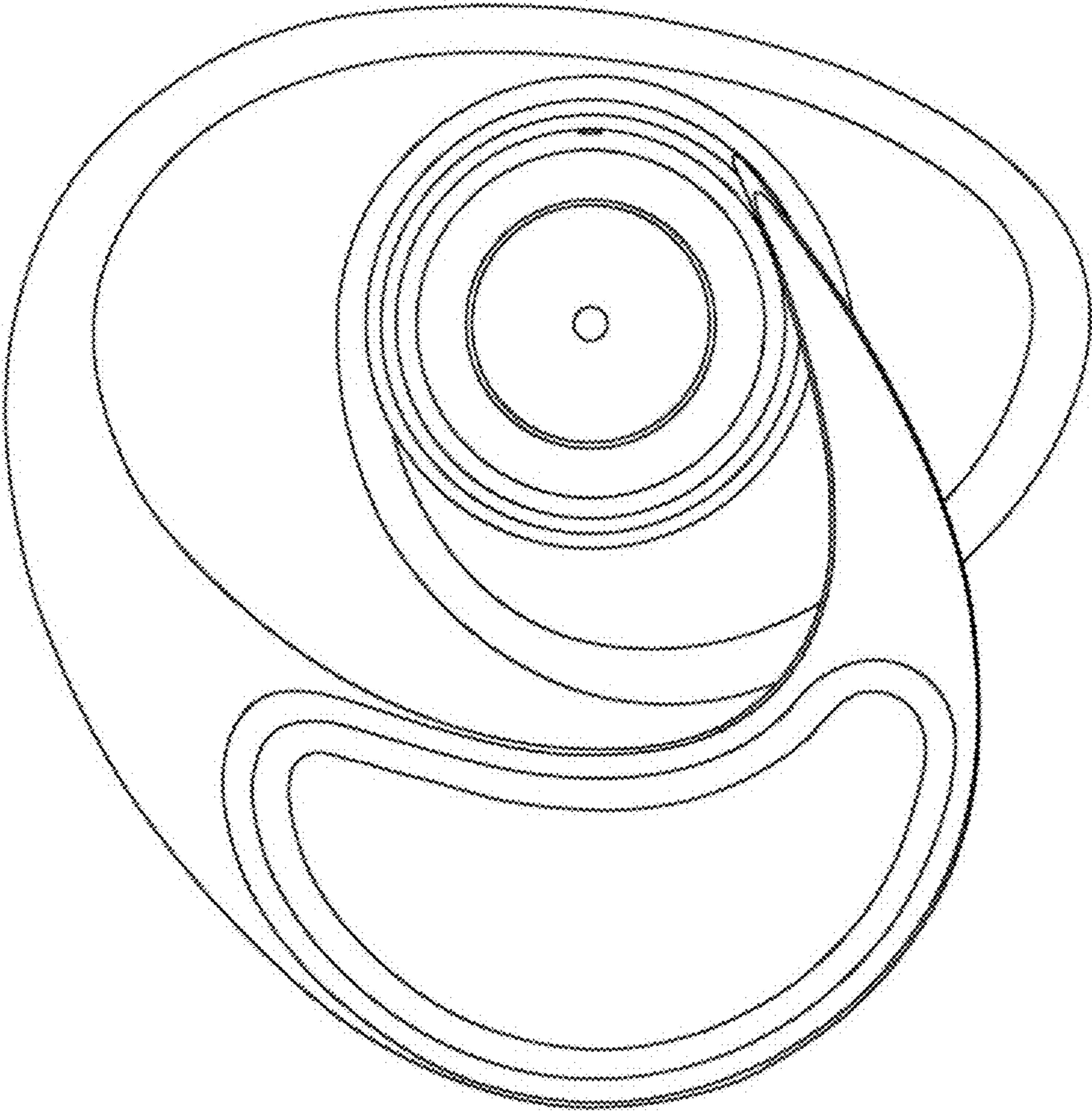

1.9

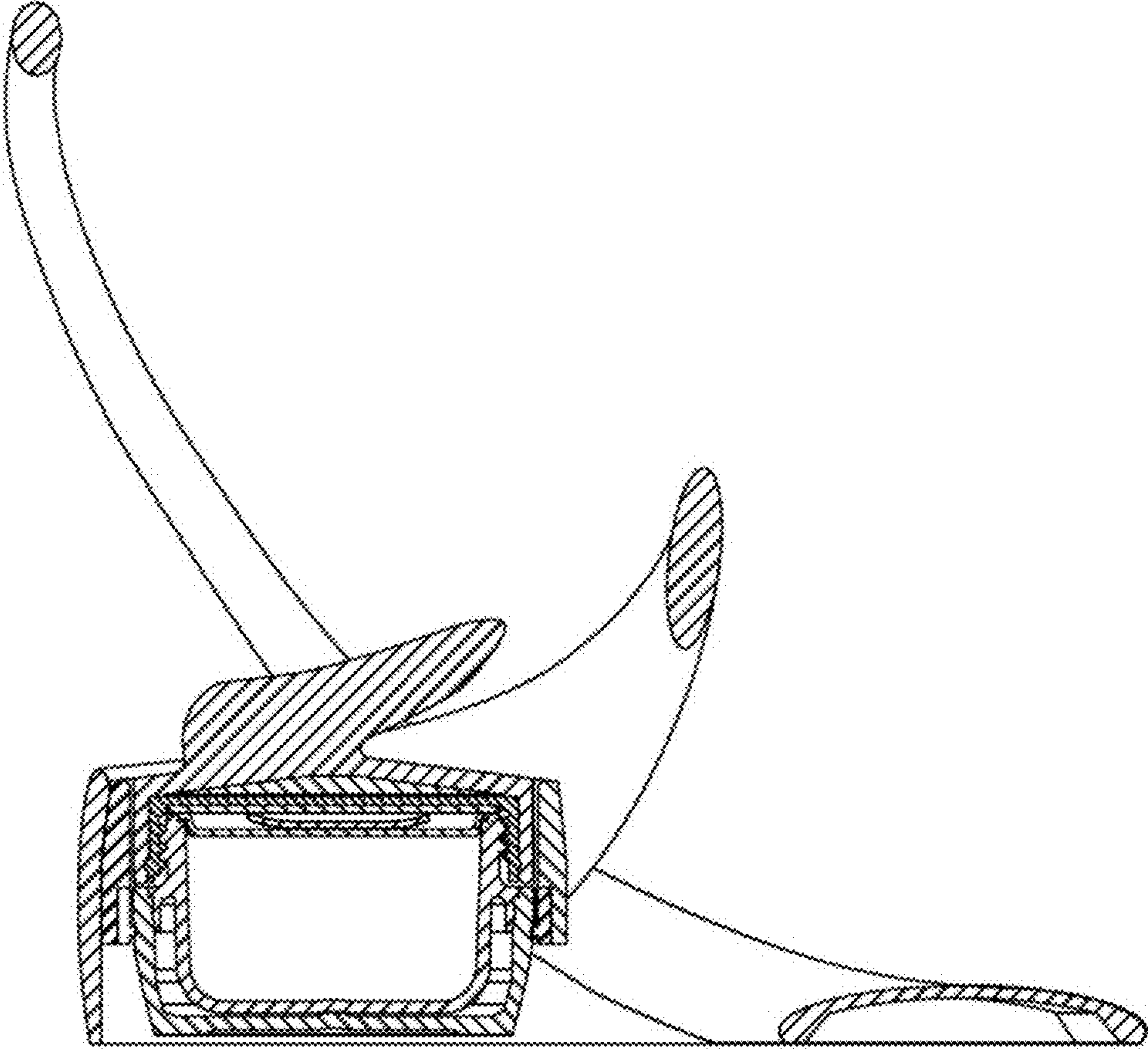

1.10

