



US00D854912S

(12) **United States Design Patent** (10) **Patent No.:** **US D854,912 S**
Brannon (45) **Date of Patent:** **** Jul. 30, 2019**

(54) **CABINET TOE KICK ASSEMBLY**
(71) Applicant: **Sympateco, Inc.**, Omaha, NE (US)
(72) Inventor: **Curt Brannon**, Omaha, NE (US)
(73) Assignee: **SYMPATECO, INC.**, Omaha, NE (US)
(**) Term: **15 Years**
(21) Appl. No.: **29/574,910**
(22) Filed: **Aug. 19, 2016**
(51) **LOC (11) Cl.** **08-08**
(52) **U.S. Cl.**

USPC **D8/349**
(58) **Field of Classification Search**
USPC D6/672, 684, 680, 683.1, 703.5; D8/349,
D8/354, 355, 330, 380, 382; D13/154,
D13/133, 129, 199; D25/119, 164, 199,
D25/139, 141; D26/138, 76, 78, 79, 80
CPC .. F16C 2314/72; F16C 29/0623; F16C 29/06;
F16C 29/0609; F16C 29/005; F16C
29/008; F16C 29/04; F16C 29/0657;
F16C 29/004; F16C 29/12; A47B 1/10;
A47B 88/493; A47B 88/423; A47B
2088/4235

See application file for complete search history.

(56) **References Cited**

U.S. PATENT DOCUMENTS

D507,353 S * 7/2005 Rasmussen D25/119
D557,112 S * 12/2007 Franssen D8/349
D639,147 S * 6/2011 Surles D8/356
D683,893 S * 6/2013 Ransvi D26/138
D745,368 S * 12/2015 Lutze D13/184
D769,105 S * 10/2016 Tomney D12/217

D808,777 S * 1/2018 Ruddick D8/356
D822,459 S * 7/2018 Kobayashi D8/356
2010/0132979 A1* 6/2010 Chen F16L 3/223
174/135

* cited by examiner

Primary Examiner — Mark A Goodwin

Assistant Examiner — Benjamin M Weeks

(74) *Attorney, Agent, or Firm* — Ryan T. Grace; Advent, LLP

(57) **CLAIM**

The ornamental design for a cabinet toe kick assembly, as shown and described.

DESCRIPTION

FIG. 1 is a top plan view of a cabinet toe kick assembly. FIG. 2 is a bottom plan view of the cabinet toe kick assembly of FIG. 1. FIG. 3 is a front elevation view of the cabinet toe kick assembly of FIG. 1. FIG. 4 is a back elevation view of the cabinet toe kick assembly of FIG. 1. FIG. 5 is a left side view of the cabinet toe kick assembly of FIG. 1. FIG. 6 is a right side view of the cabinet toe kick assembly of FIG. 1. FIG. 7 is an isometric view of the cabinet toe kick assembly of FIG. 1; and, FIG. 8 is another isometric view of the cabinet toe kick assembly of FIG. 1. Portions of FIGS. 1 through 8 are shown in broken lines illustrating portions of the article that form no part of the claimed design.

1 Claim, 8 Drawing Sheets

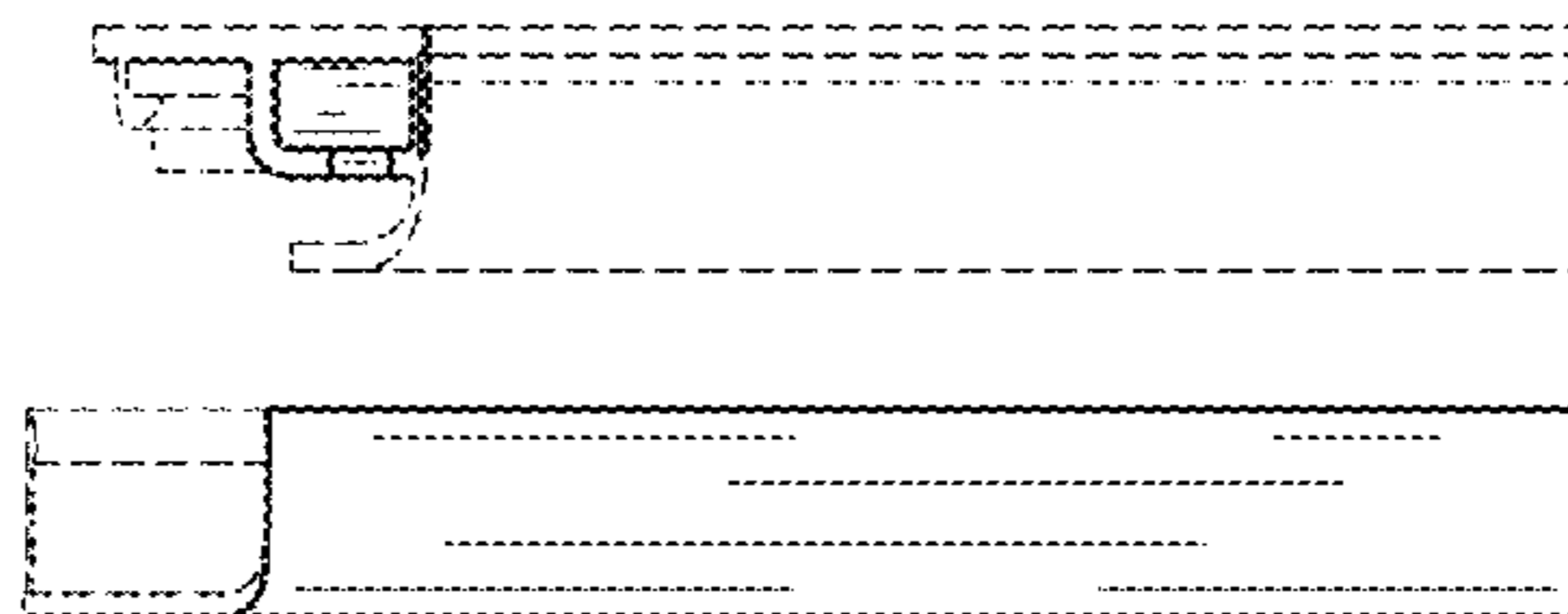
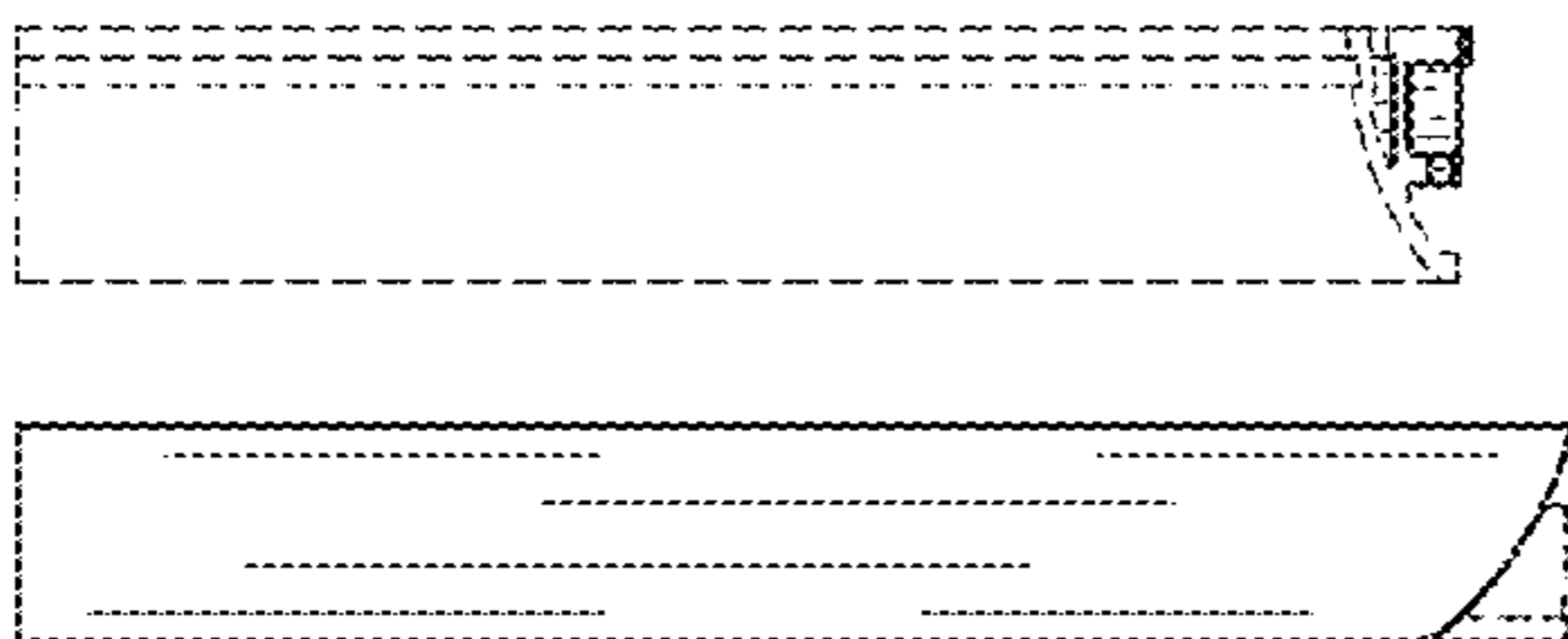

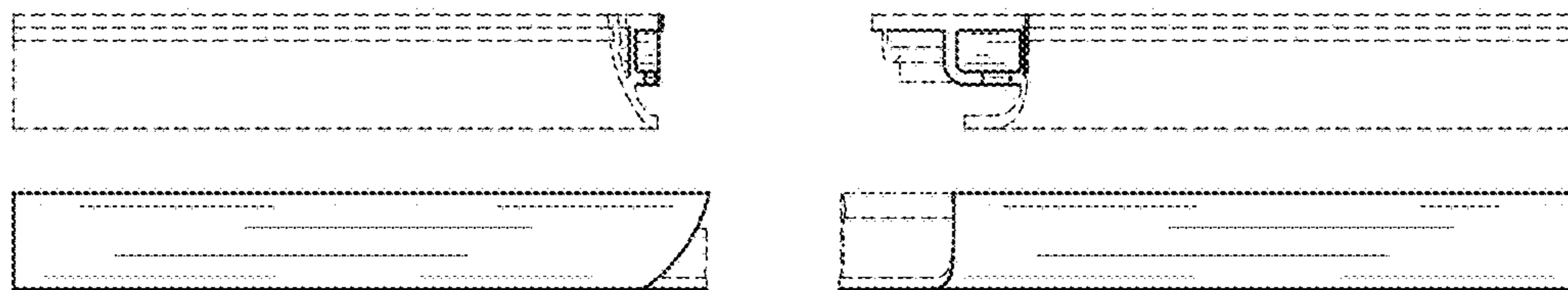

FIG. 1

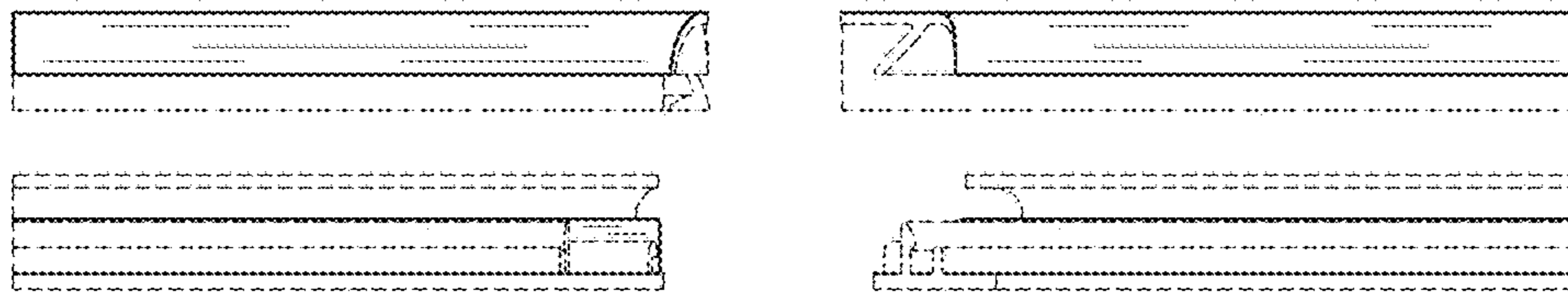

FIG. 2

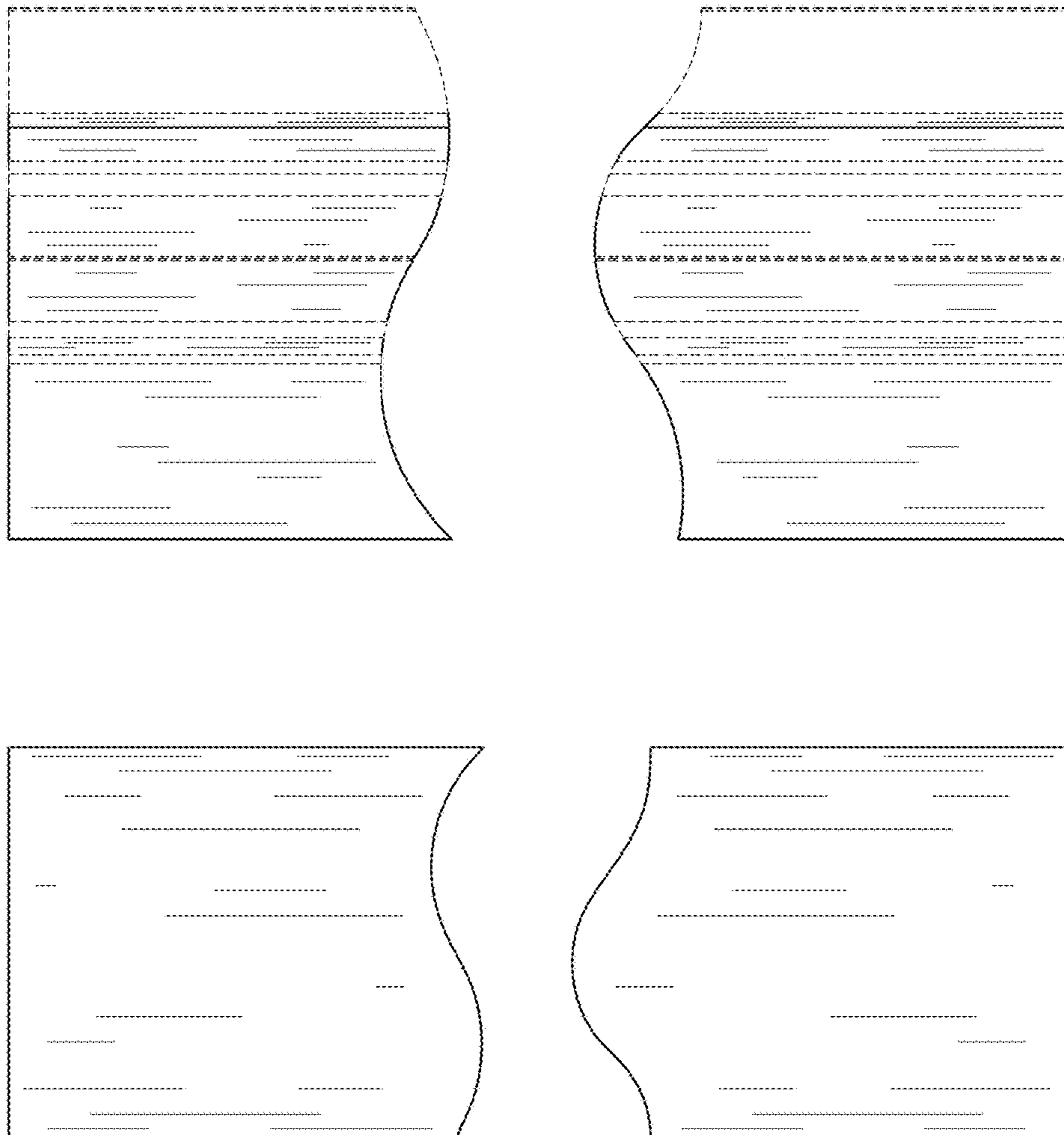

FIG. 3

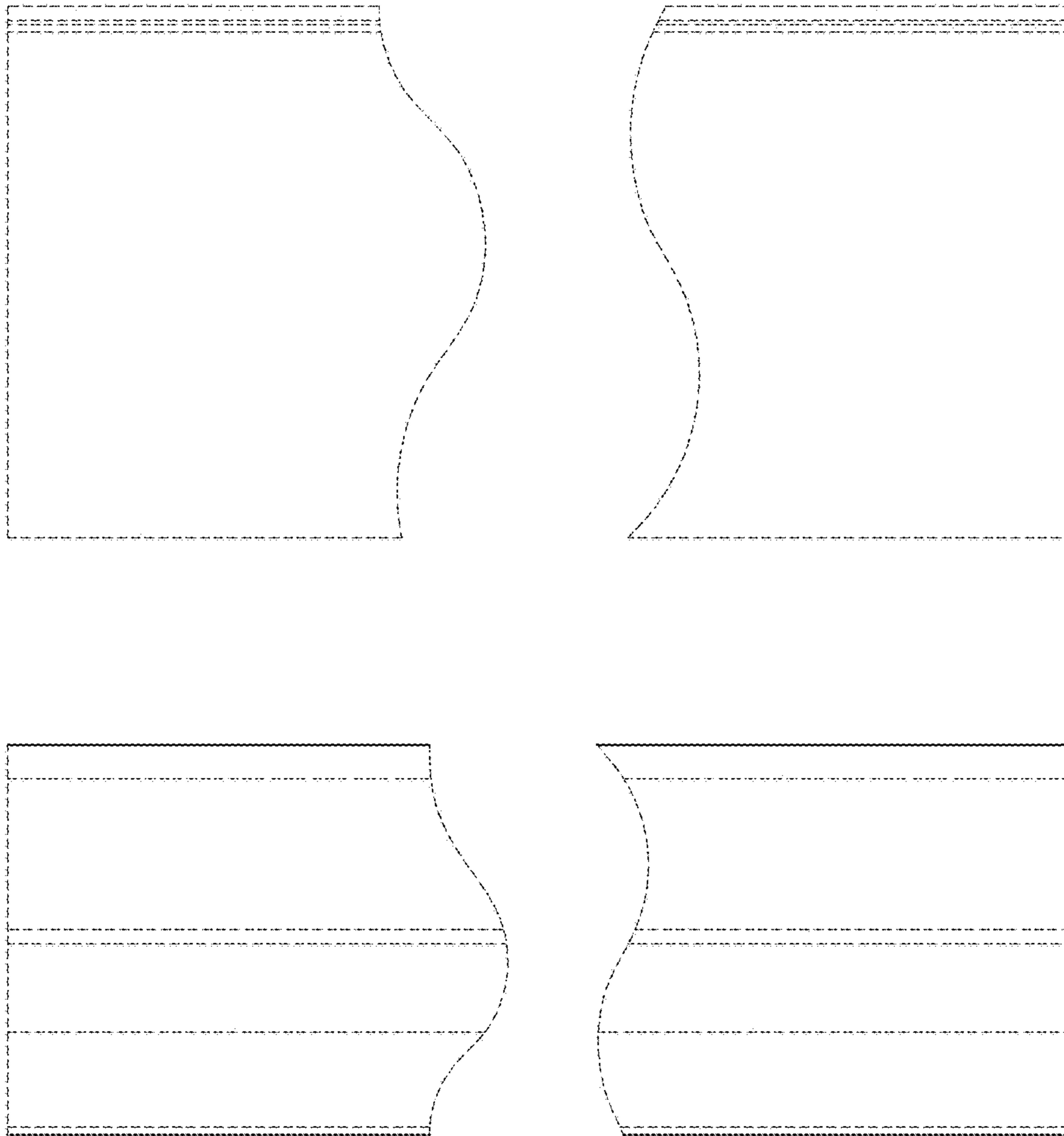

FIG. 4



FIG. 5

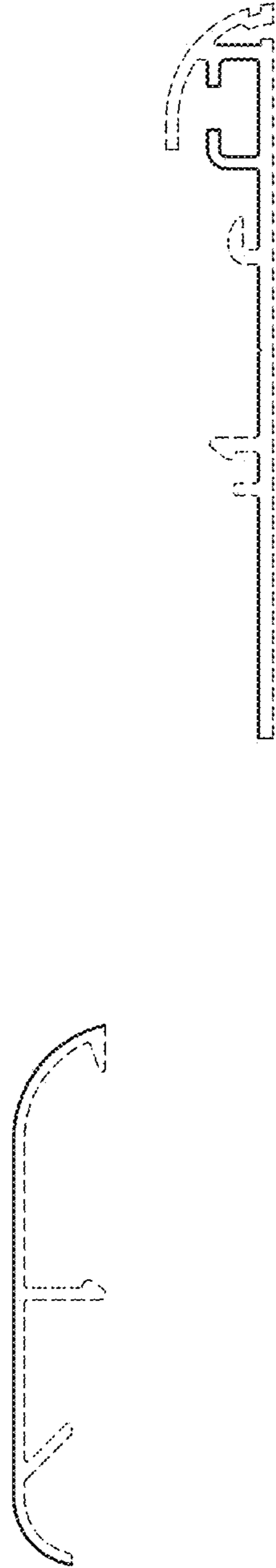

FIG. 6

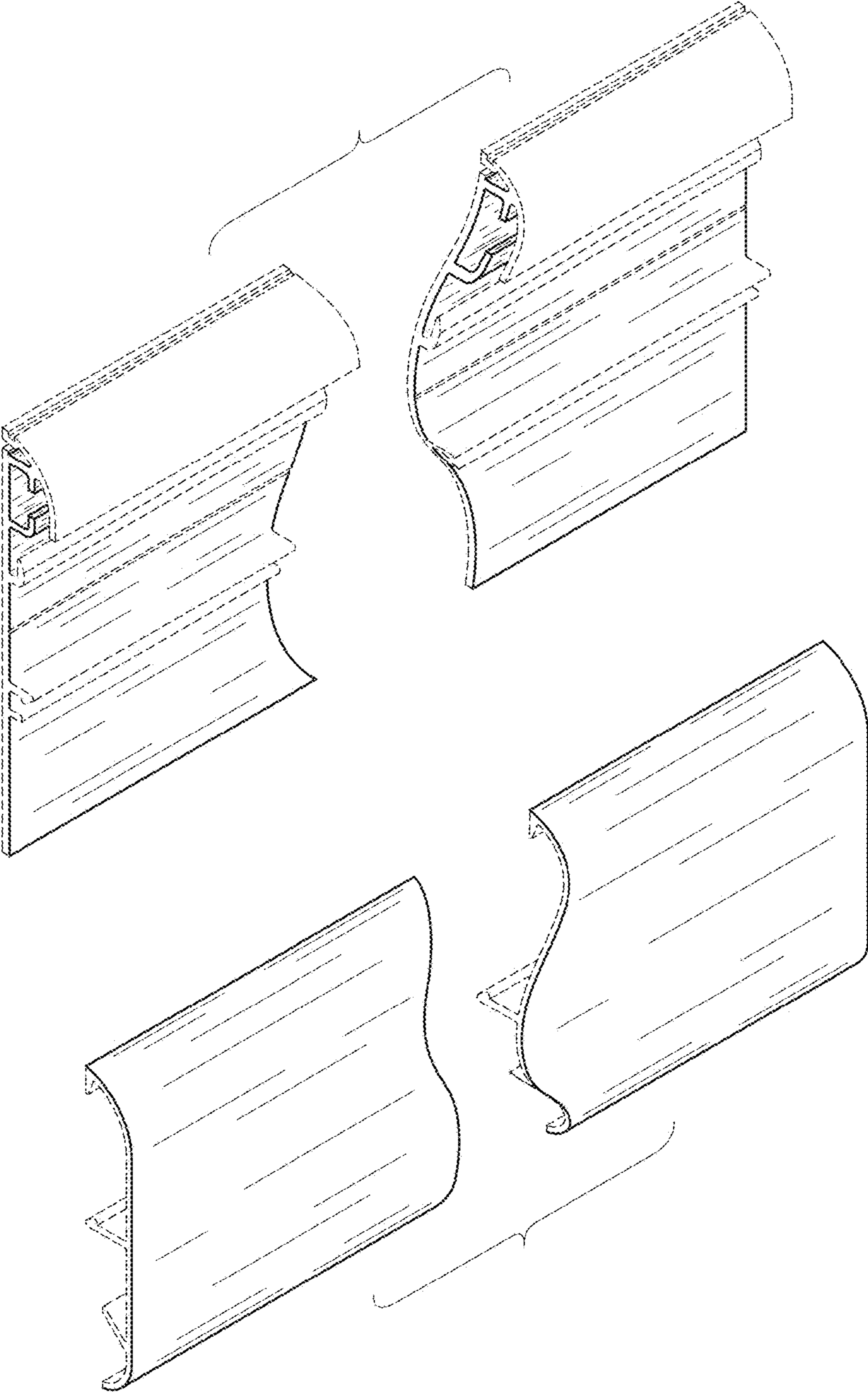

FIG. 7

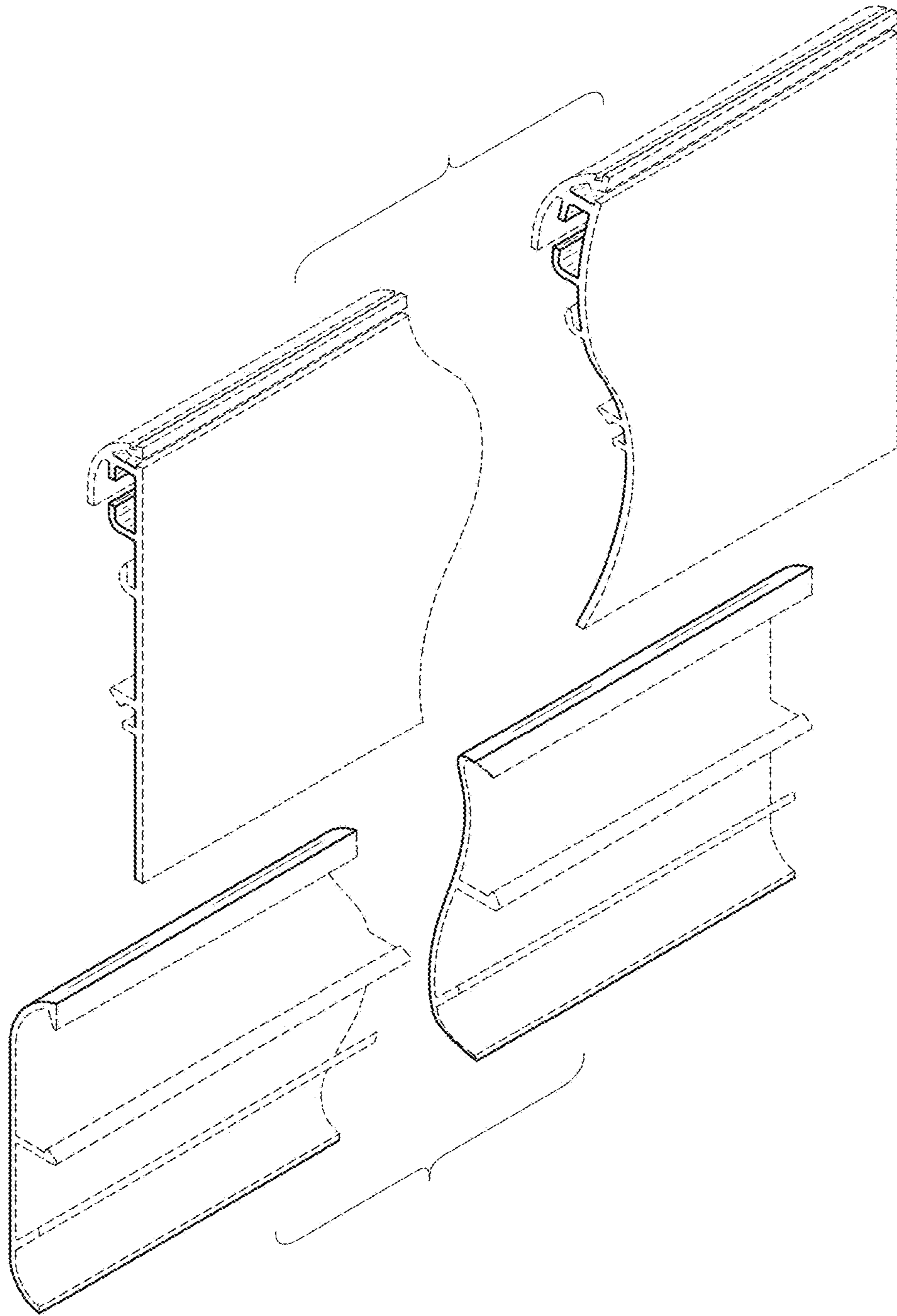

FIG. 8