



US00D854908S

(12) **United States Design Patent**  
**Jeffries et al.**

(10) **Patent No.:** **US D854,908 S**

(45) **Date of Patent:** **\*\* Jul. 30, 2019**

(54) **HANDLE**

(71) Applicant: **Austin Hardware & Supply, Inc.**,  
Lee's Summit, MO (US)

(72) Inventors: **Mark Steven Jeffries**, Buford, GA  
(US); **Norman Allen Smith**, Buford,  
GA (US)

(73) Assignee: **Austin Hardware And Supply, Inc.**,  
Lee's Summit, MO (US)

(\*\*) Term: **15 Years**

(21) Appl. No.: **29/647,323**

(22) Filed: **May 11, 2018**

(51) **LOC (11) Cl.** ..... **08-06**

(52) **U.S. Cl.**  
USPC ..... **D8/303**

(58) **Field of Classification Search**

USPC ..... D8/107, 300, 303, 307, 310, 321, 322;  
D23/250-254; D7/393, 394, 395, 396

CPC ..... Y10T 16/469; Y10T 16/44; Y10T 16/466;  
Y10T 16/4713; Y10T 16/459; Y10T  
74/20828; Y10T 29/49826; Y10T  
74/20732; Y10T 16/4559; Y10T  
74/20864; Y10T 74/20822; A46B 5/026;  
A46B 2200/302; A46B 5/021; A47L  
13/022; A47L 1/06; A47L 13/20; A47L  
11/4075; B25G 1/10; B25G 1/00; B25G  
3/04; B25G 3/00; Y10S 16/12; Y10S  
16/19; Y10S 16/41; Y10S 16/90; Y10S  
16/40

See application file for complete search history.

(56) **References Cited**

**U.S. PATENT DOCUMENTS**

5,056,945 A \* 10/1991 Klodt ..... B43K 23/008  
401/6

D352,442 S \* 11/1994 Lee-Chang ..... D8/303

(Continued)

*Primary Examiner* — Lauren R Calve

(74) *Attorney, Agent, or Firm* — Polsinelli PC

(57) **CLAIM**

The ornamental design for a handle, as shown and described.

**DESCRIPTION**

FIG. 1 is a perspective view of a handle;  
FIG. 2 is a partial enlarged view of the handle according to  
the broken circle 2-2 indicated in FIG. 1;  
FIG. 3 is a front view of the handle;  
FIG. 4 is a rear view of the handle;  
FIG. 5 is a top view of the handle;  
FIG. 6 is a bottom view of the handle;  
FIG. 7 is a first end view of the handle;  
FIG. 8 is a second end view of the handle;  
FIG. 9 is a perspective view of a second embodiment of the  
handle;  
FIG. 10 is a partial enlarged view of the second embodiment  
of the handle according to the broken circle 10-10 indicated  
in FIG. 9;  
FIG. 11 is a front view of the second embodiment of the  
handle;  
FIG. 12 is a rear view of the second embodiment of the  
handle;  
FIG. 13 is a top view of the second embodiment of the  
handle;  
FIG. 14 is a bottom view of the second embodiment of the  
handle;  
FIG. 15 is a first end view of the second embodiment of the  
handle; and,  
FIG. 16 is a second end view of the second embodiment of  
the handle.

The broken lines showing in the figures are included for the  
purpose of illustrating portions of the handle that form no  
part of the claimed design.

The claim is shown with a symbolic break in its length. The  
appearance of any portion of the article between the break  
lines forms no part of the claimed design.

**1 Claim, 8 Drawing Sheets**

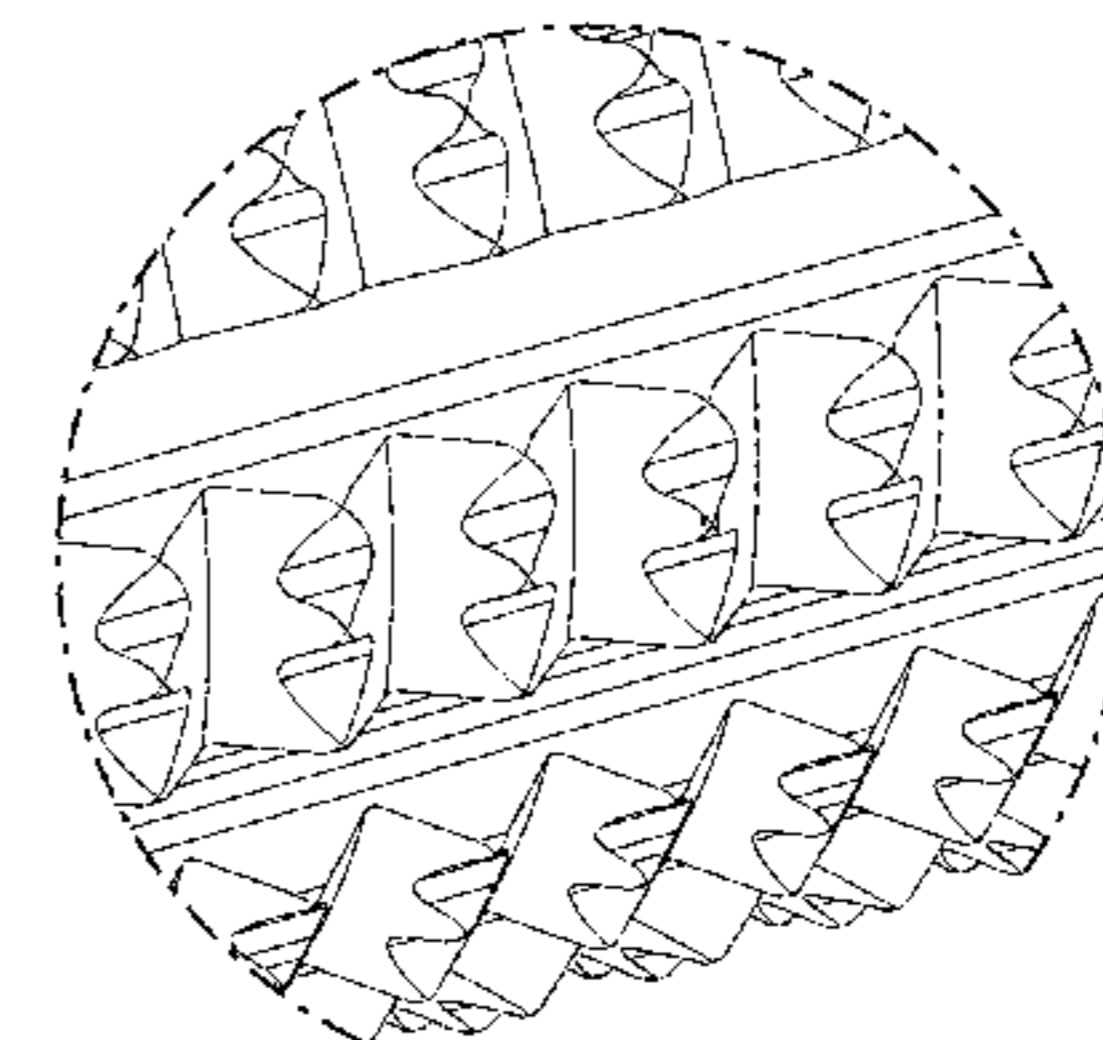
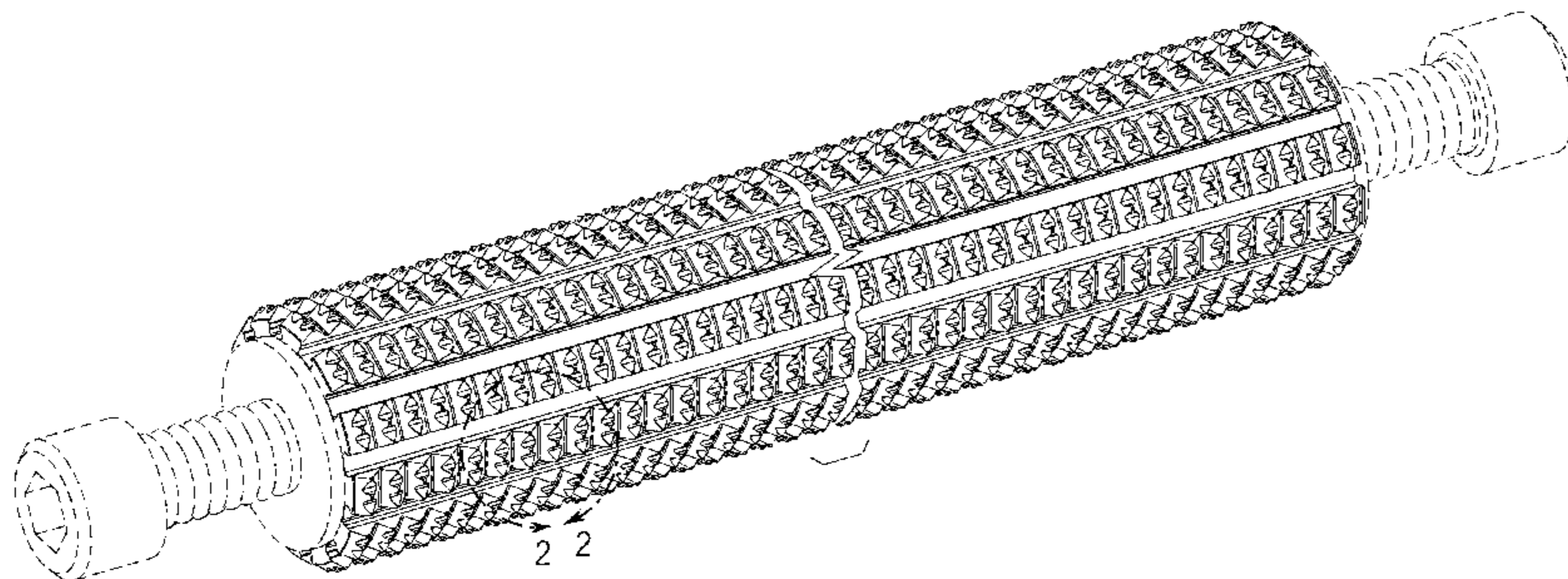

(56)

References Cited

U.S. PATENT DOCUMENTS

6,145,995 A \* 11/2000 Hung ..... B25B 23/18  
 362/119  
 D565,384 S \* 4/2008 Chen ..... D8/303  
 D611,784 S \* 3/2010 Girard ..... D8/25  
 D696,923 S \* 1/2014 Ichikawa ..... D8/303  
 D697,782 S \* 1/2014 Lee ..... D8/107  
 D698,219 S \* 1/2014 Lee ..... D8/107  
 D776,504 S \* 1/2017 Lee ..... D8/29  
 D788,313 S \* 5/2017 Lawrie ..... D24/211  
 D813,005 S \* 3/2018 Dovellos ..... D8/303  
 D815,508 S \* 4/2018 Dovellos ..... D8/303  
 2001/0022119 A1 \* 9/2001 Kuo ..... B25B 13/105  
 81/185  
 2004/0093979 A1 \* 5/2004 Rosenthal ..... B62K 21/26  
 74/551.9  
 2006/0123600 A1 \* 6/2006 Morse ..... B25G 1/005  
 16/421  
 2008/0196540 A1 \* 8/2008 Wu ..... B62K 21/26  
 74/551.9  
 2011/0264074 A1 \* 10/2011 Tegg ..... A61B 8/12  
 604/523  
 2012/0073400 A1 \* 3/2012 Wang ..... B62K 21/26  
 74/551.9  
 2013/0133467 A1 \* 5/2013 Slone ..... B62K 21/26  
 74/551.9  
 2013/0205636 A1 \* 8/2013 Shull ..... F41C 23/04  
 42/72  
 2014/0134359 A1 \* 5/2014 Hart ..... A47K 17/022  
 428/34.1  
 2015/0190304 A1 \* 7/2015 Lawrie ..... A61H 15/0092  
 601/118  
 2016/0310349 A1 \* 10/2016 Chen ..... A61H 15/00  
 2017/0123299 A1 \* 5/2017 Tonev ..... G03B 3/00  
 2018/0288978 A1 \* 10/2018 Victory ..... B25B 5/06

\* cited by examiner

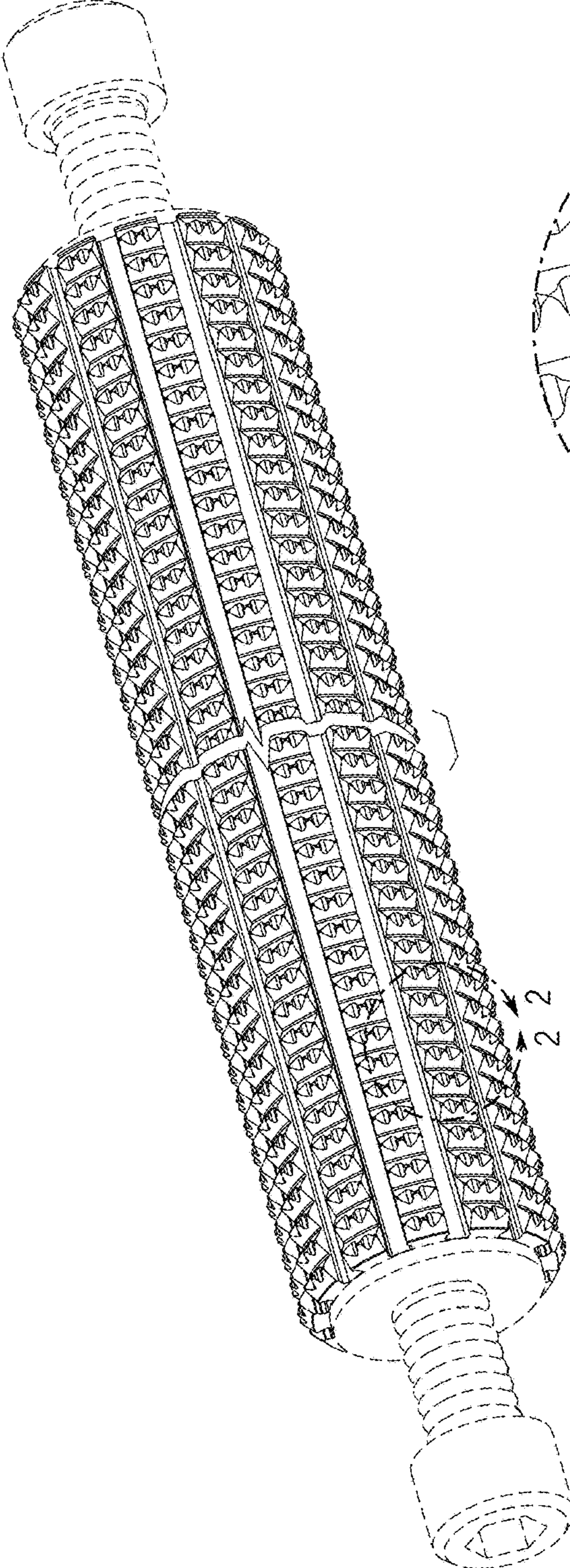

FIG. 1

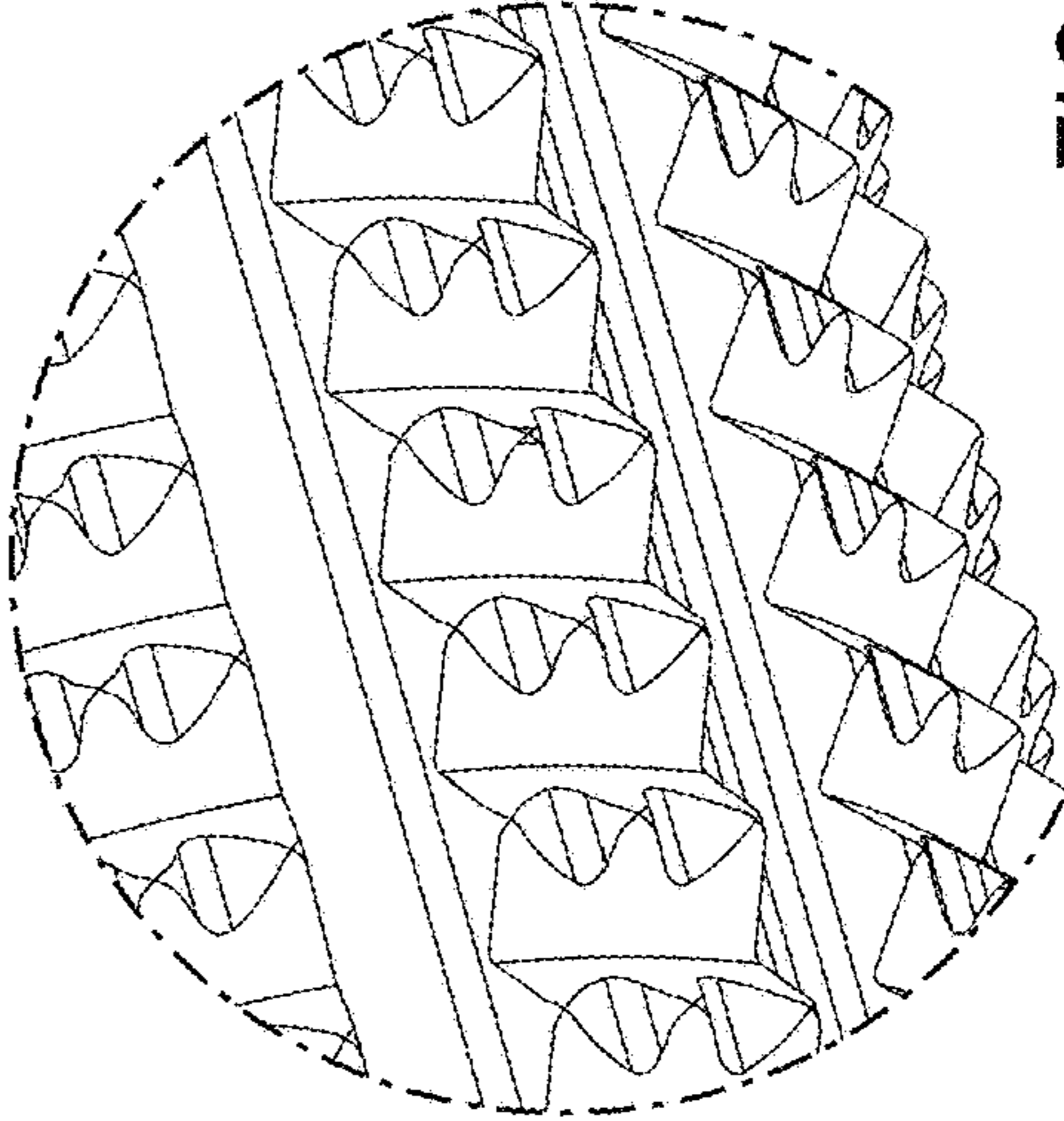

FIG. 2

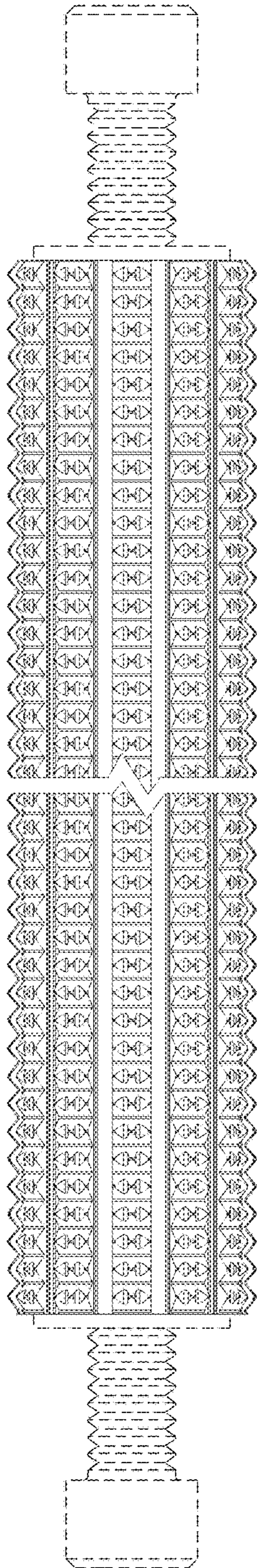

FIG. 3

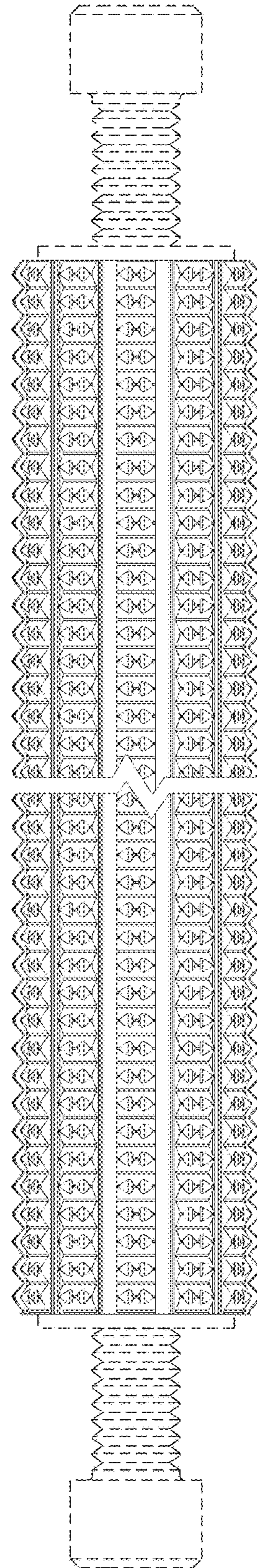

FIG. 4

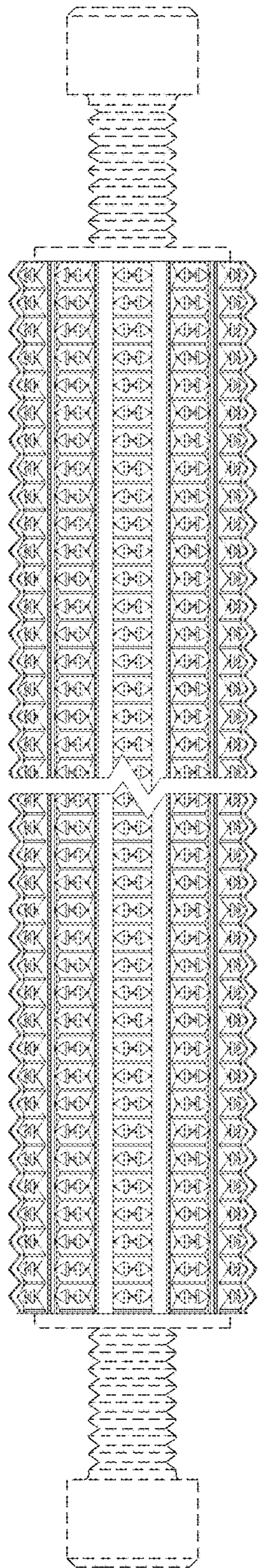

FIG. 5

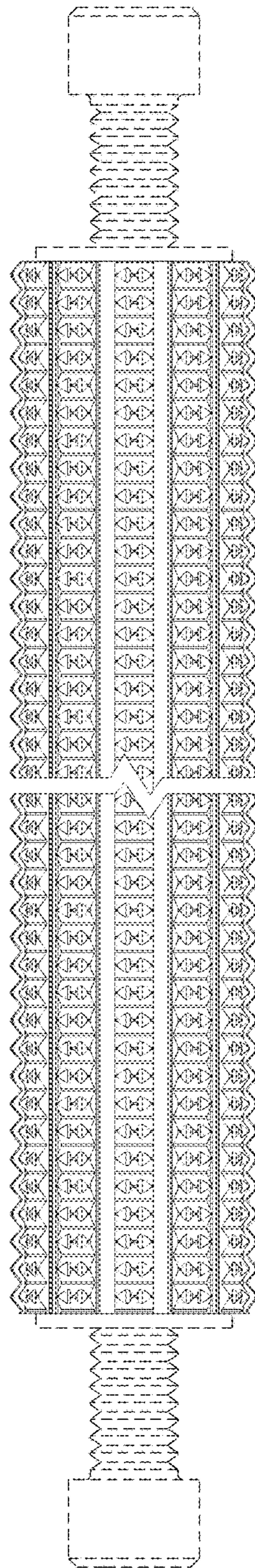

FIG. 6

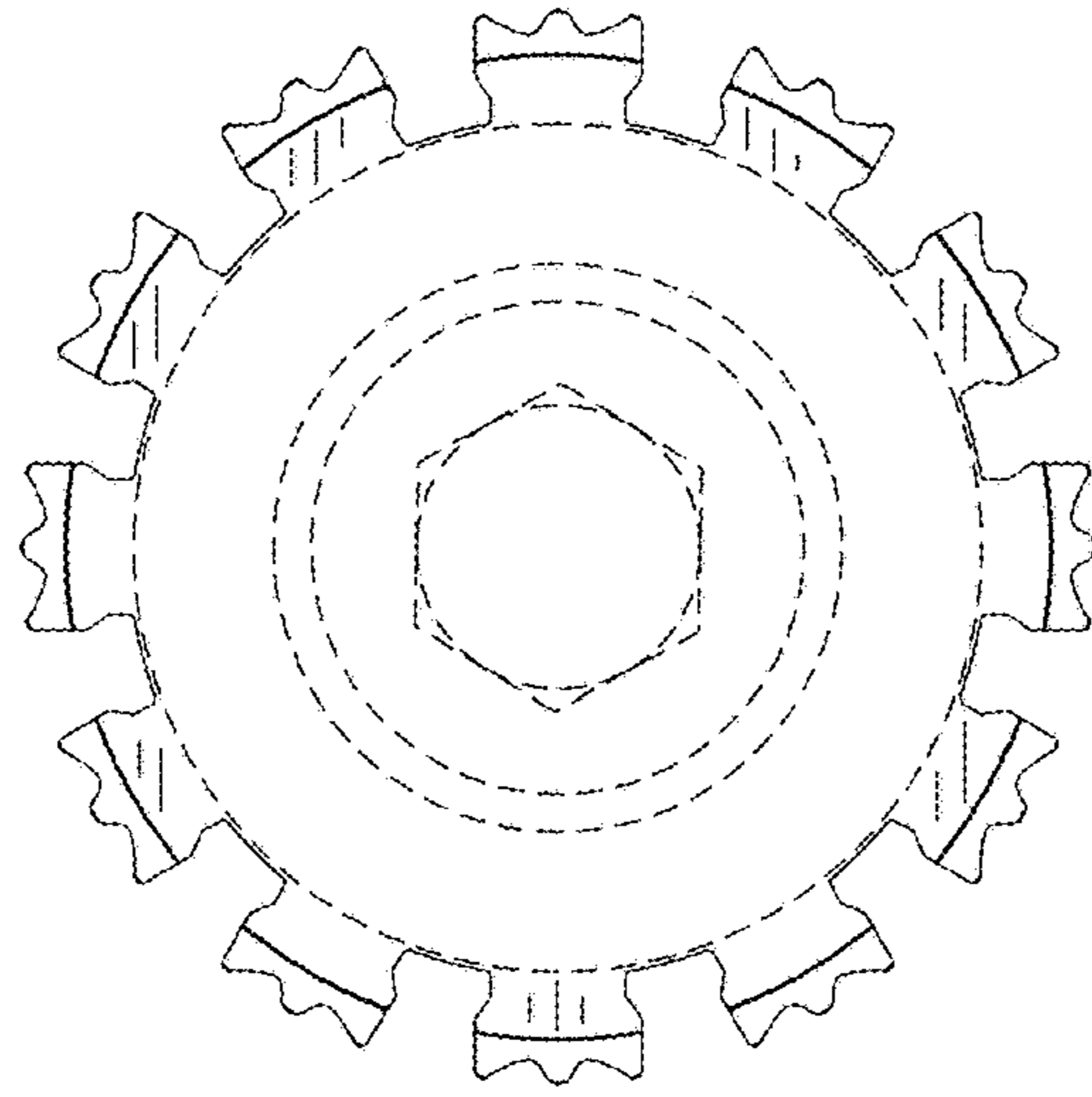

FIG. 8

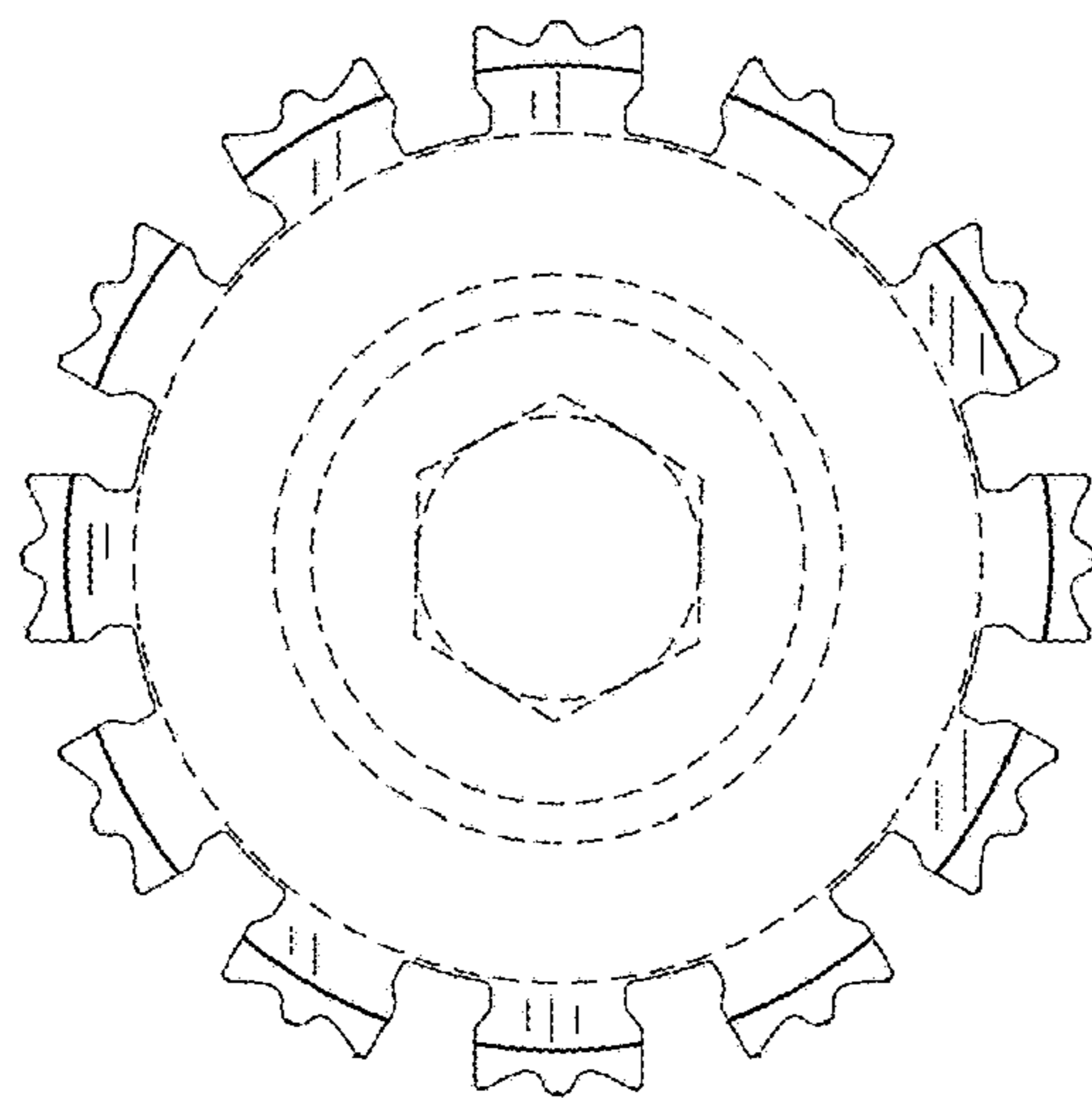

FIG. 7

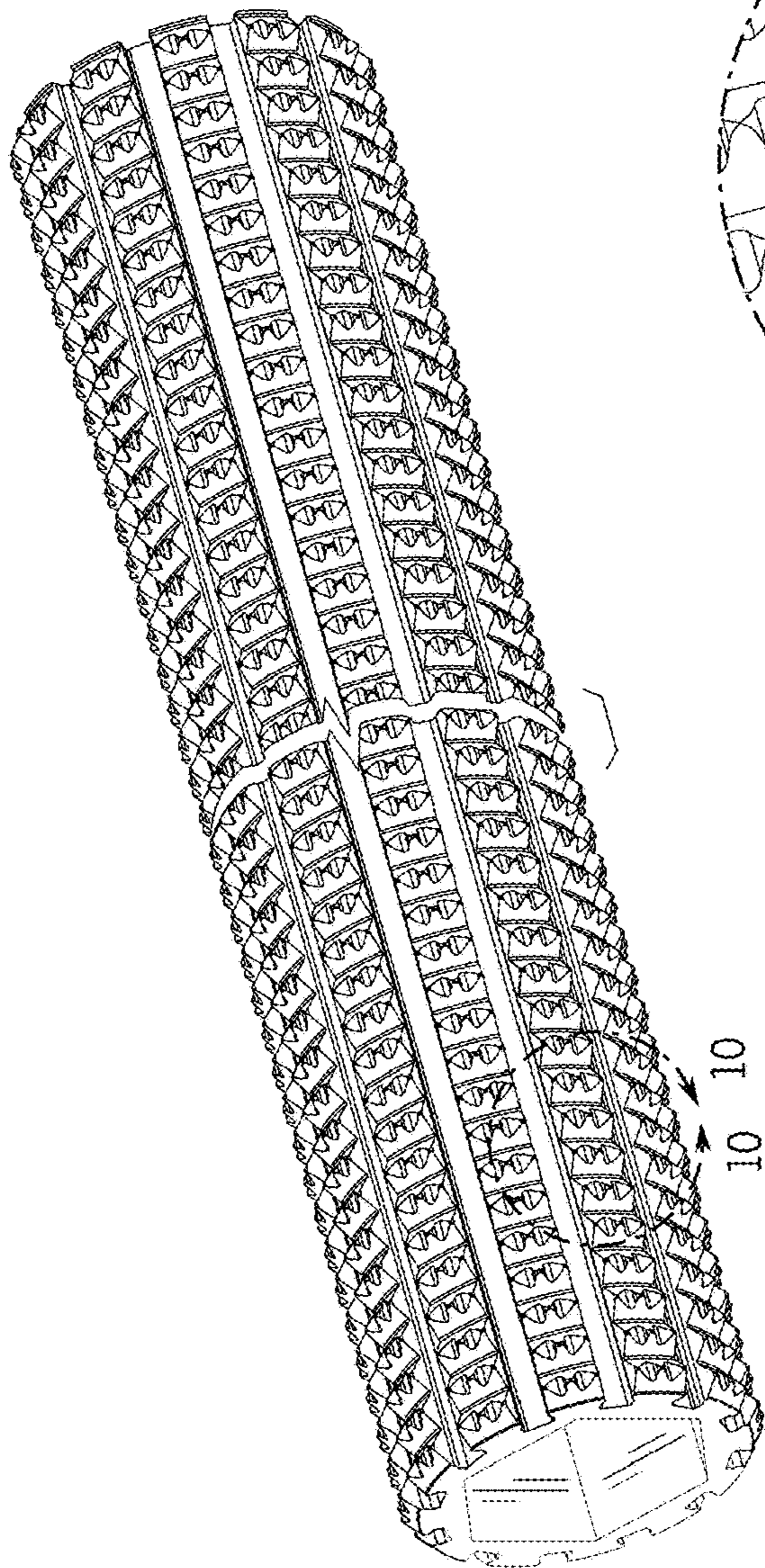

FIG. 9

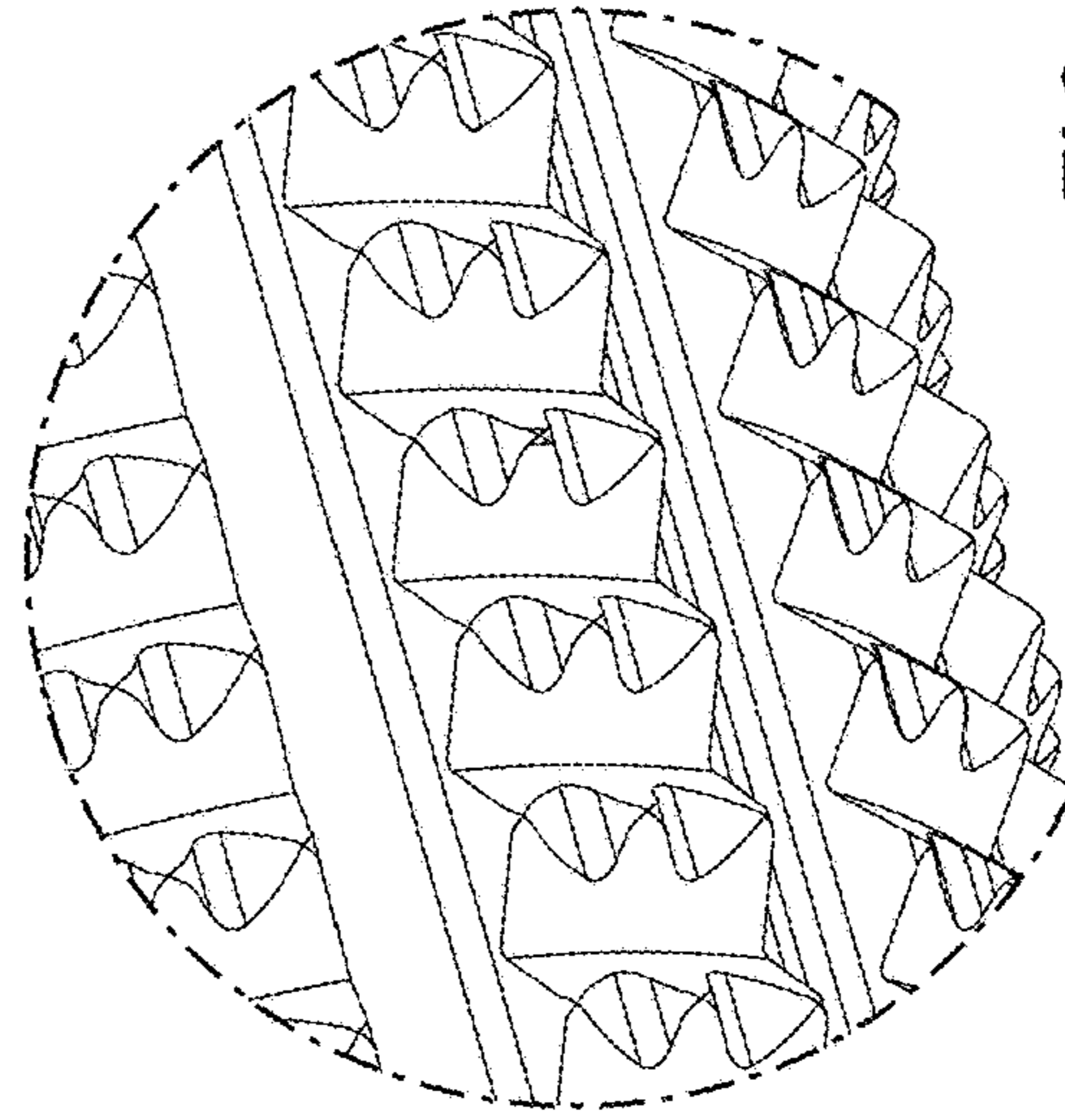

FIG. 10

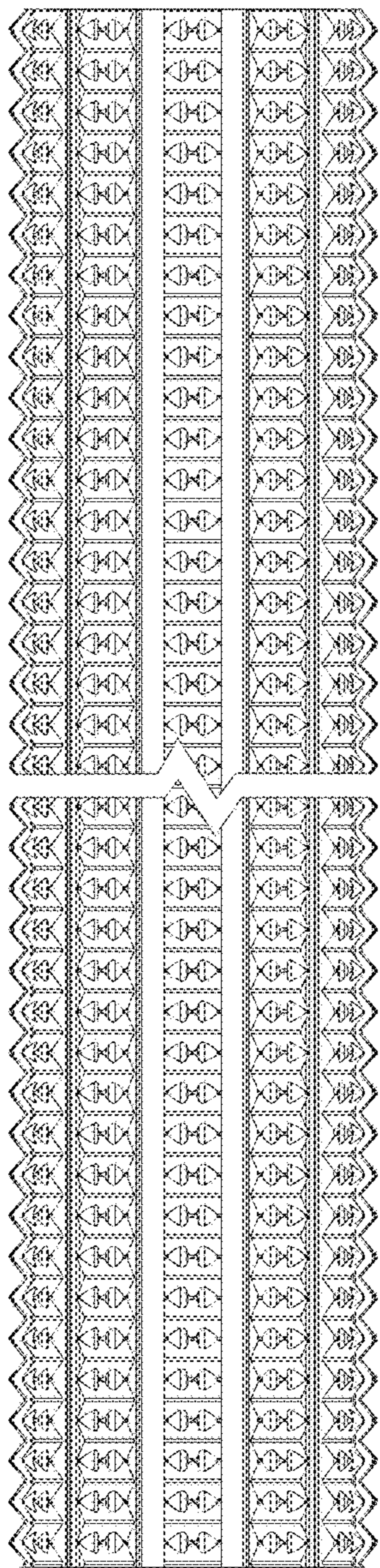

FIG. 11

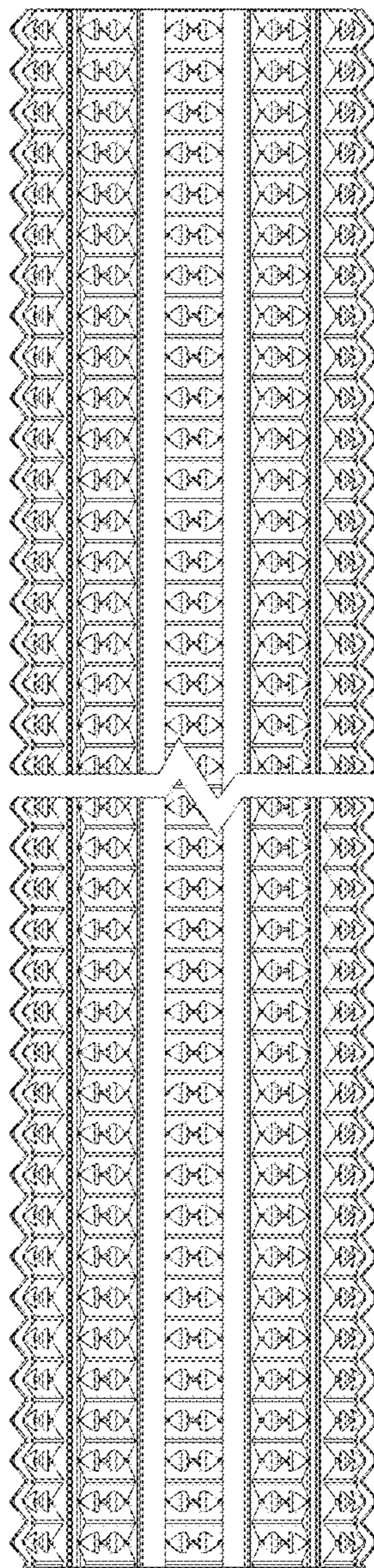

FIG. 12



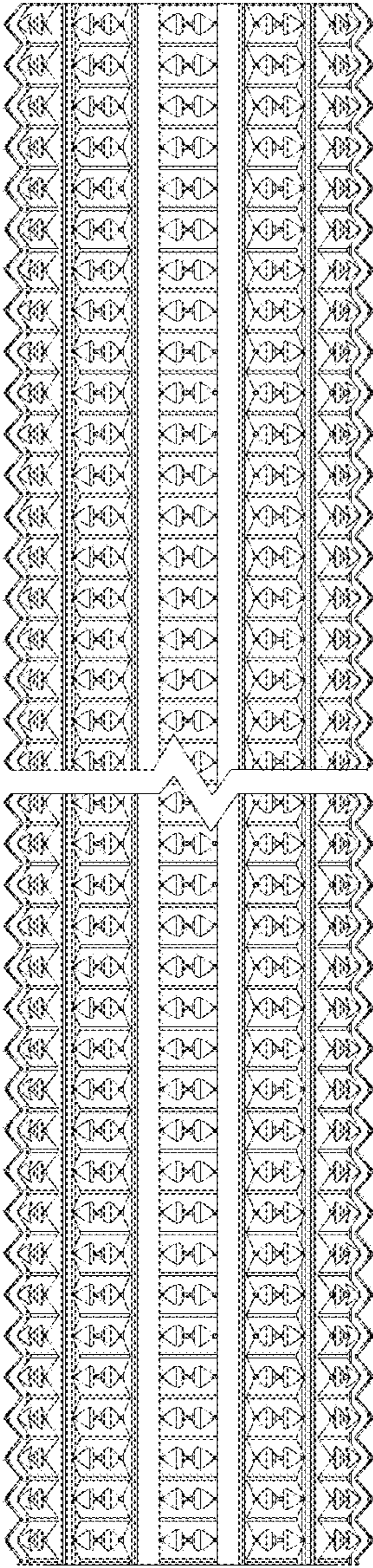

FIG. 13

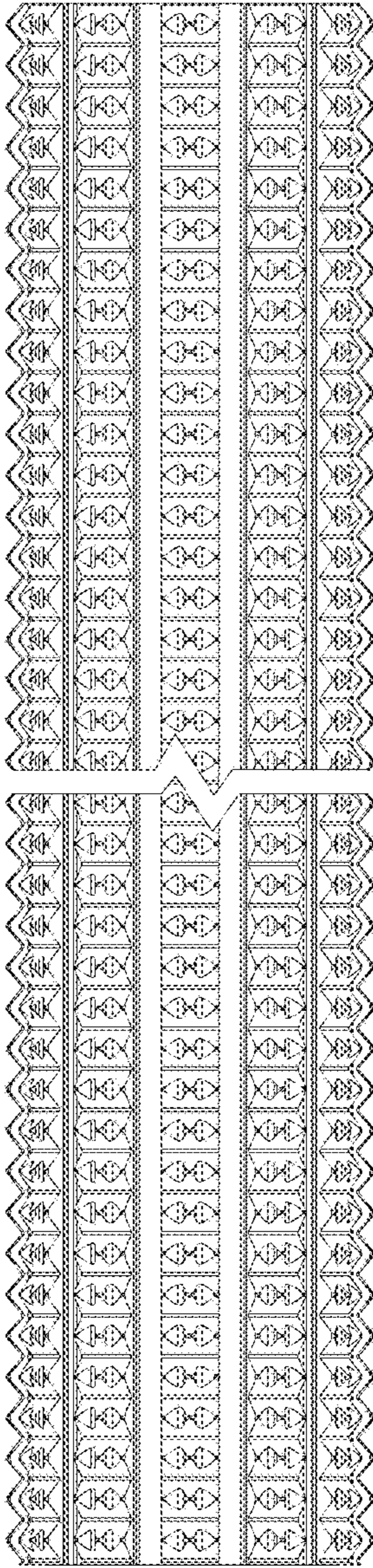

FIG. 14

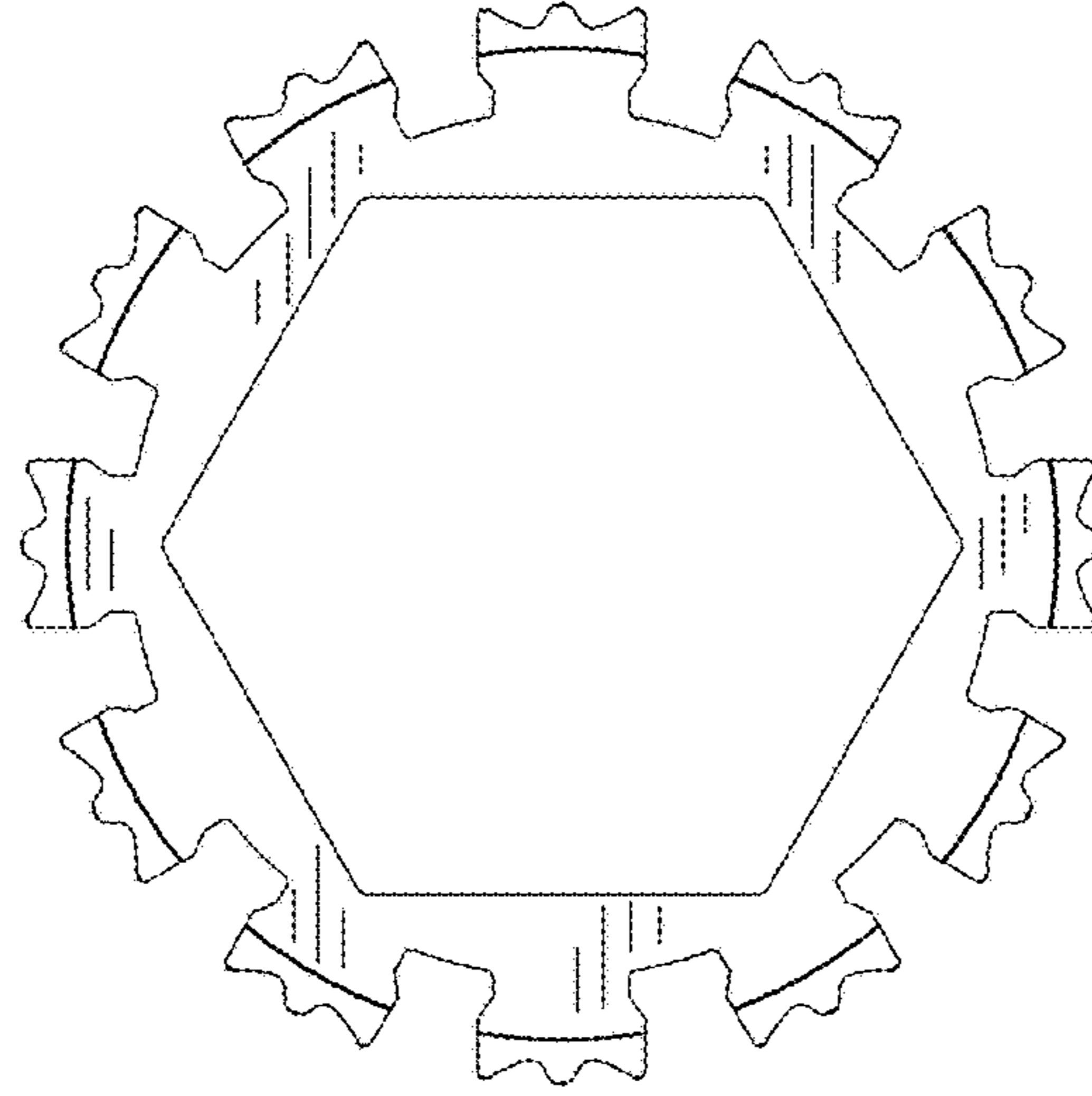

FIG. 16

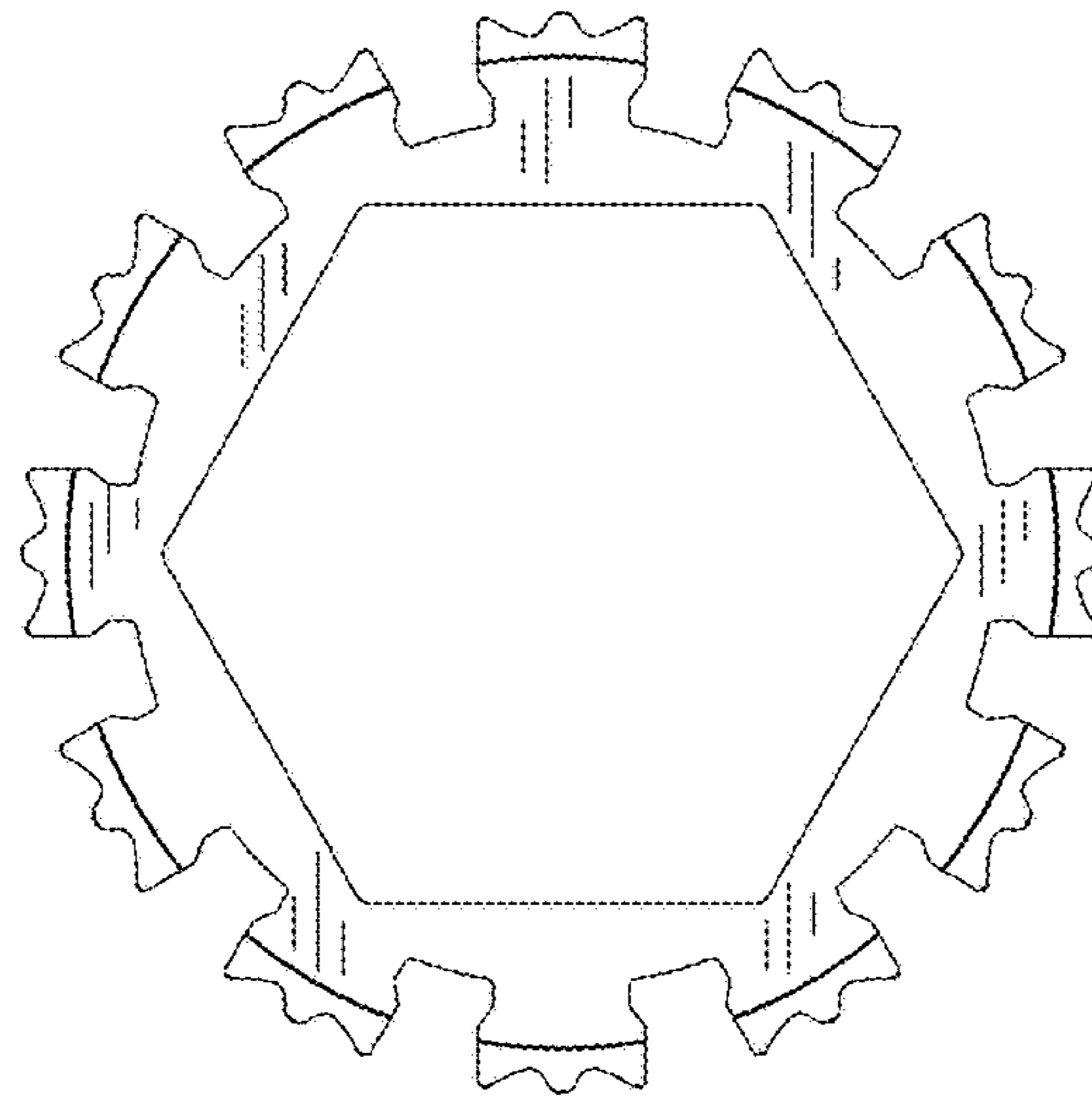

FIG. 15