



US00D854889S

(12) **United States Design Patent**
Kim

(10) **Patent No.:** **US D854,889 S**

(45) **Date of Patent:** **** *Jul. 30, 2019**

(54) **CONTAINER FOR FRUIT OR VEGETABLE WASH**

(71) Applicant: **JISUNG INDUSTRY INC.**, Gwangju (KR)

(72) Inventor: **Min-Joon Kim**, Gwangju (KR)

(73) Assignee: **JISUNG INDUSTRY INC.**, Gwangju (KR)

(*) Notice: This patent is subject to a terminal disclaimer.

(**) Term: **15 Years**

(21) Appl. No.: **29/685,236**

(22) Filed: **Mar. 27, 2019**

(30) **Foreign Application Priority Data**

Nov. 27, 2018 (KR) 30-2018-0055369

(51) **LOC (11) Cl.** **07-07**

(52) **U.S. Cl.**
USPC **D7/602**

(58) **Field of Classification Search**

USPC D7/602, 629, 630, 538-549, 667, 710;
D9/424, 425, 430-432
CPC A47K 1/12; A47K 1/14; A47J 19/00; A47J
19/005; B65D 2543/00296; B65D 1/00;
B65D 1/22; B65D 1/34; B65D 1/24;
B65D 1/26; B65D 3/00; B65D 3/02;
B65D 3/10; B65D 5/00; B65D 15/00;
B65D 11/00; B65D 11/02; B65D 11/10

See application file for complete search history.

(56) **References Cited**

U.S. PATENT DOCUMENTS

D223,146 S * 3/1972 Maasshoff D9/424
D229,812 S * 1/1974 Davis D7/585

D232,293 S * 8/1974 Christian et al. 220/574
D232,612 S * 9/1974 Christian et al. 220/574
D234,574 S * 3/1975 Schimkat D9/425
D248,076 S * 6/1978 Christian D7/545
4,351,447 A * 9/1982 Graff B65D 43/0212
220/793
D370,598 S * 6/1996 Koch D7/543
D405,561 S * 2/1999 Willinger D30/129
D452,417 S * 12/2001 Whitmore D7/543
D458,085 S * 6/2002 Kim
D477,970 S * 8/2003 Thonis D7/538
D480,604 S * 10/2003 Lillelund D7/543
D486,999 S * 2/2004 de Groote D7/667
D496,272 S * 9/2004 Jackson D7/602
D499,936 S * 12/2004 Wiedmeyer D7/543
D508,822 S * 8/2005 Smith D7/545
D515,873 S * 2/2006 Vendl D7/545
D517,372 S * 3/2006 Vendl D7/545
D547,179 S * 7/2007 Bouveret D9/428

(Continued)

Primary Examiner — Shannon W Morgan

(74) *Attorney, Agent, or Firm* — IPLA P.A.; James E. Bame

(57) **CLAIM**

The ornamental design for a container for fruit or vegetable wash, as shown and described.

DESCRIPTION

FIG. 1 is a perspective view of a container for fruit or vegetable wash showing my new design;
FIG. 2 is a front elevational view thereof, the opposite side being a mirror image;
FIG. 3 is a side elevational view thereof, the opposite side being a mirror image;
FIG. 4 is a top plan view thereof;
FIG. 5 is a bottom plan view thereof;
FIG. 6 is a cross-sectional view taken along line VI-VI in FIG. 4; and,
FIG. 7 is a cross-sectional view taken along line VII-VII in FIG. 4.

1 Claim, 4 Drawing Sheets

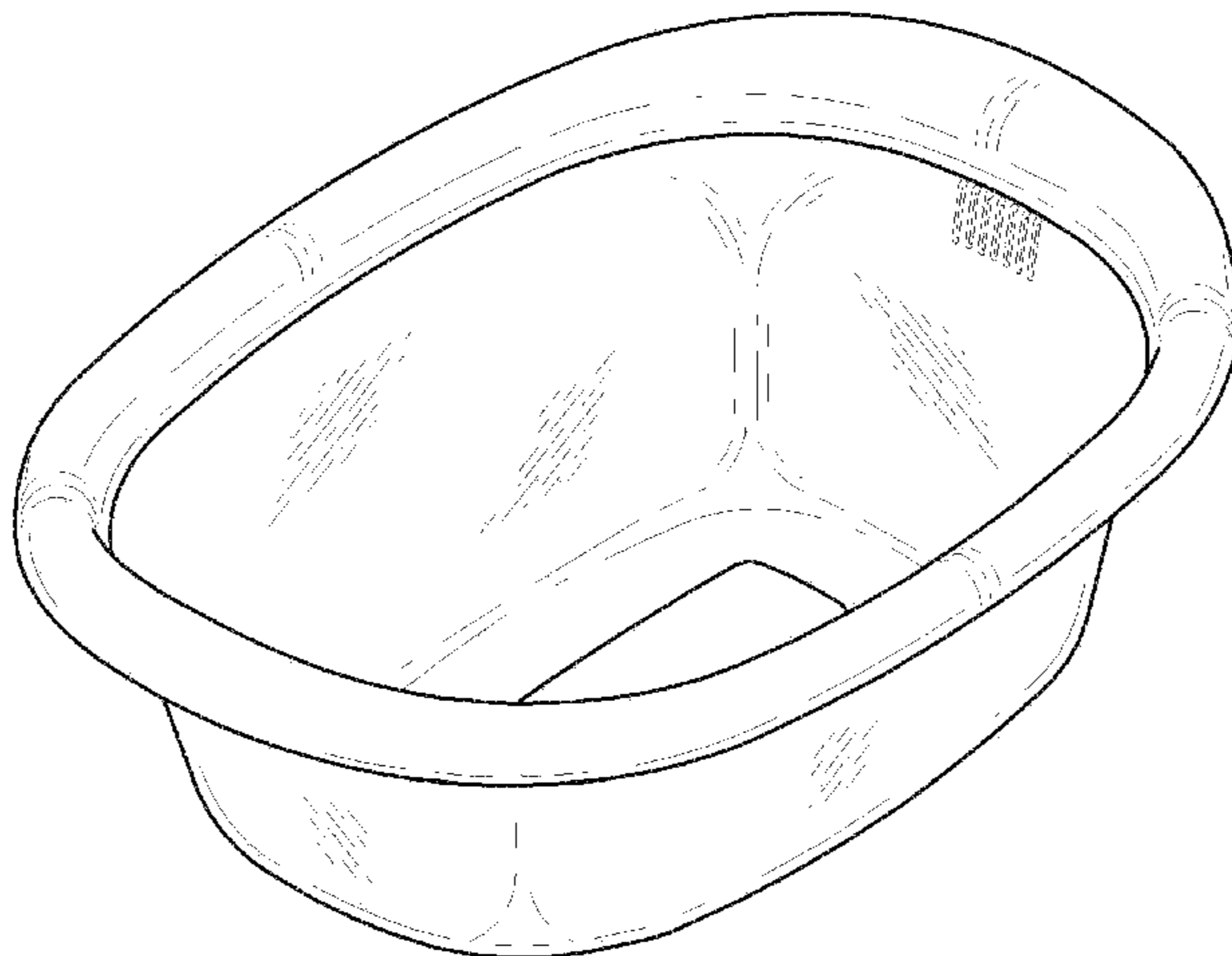

(56)

References Cited

U.S. PATENT DOCUMENTS

D571,156	S *	6/2008	Gartz	D7/545
D657,617	S *	4/2012	Sarnoff	D7/354
D669,744	S	10/2012	Cossu	
D679,546	S *	4/2013	Chen	D7/545
D679,547	S *	4/2013	Chen	D7/545
D679,548	S *	4/2013	Chen	D7/545
D679,556	S *	4/2013	Chen	D7/667
D697,764	S *	1/2014	Carlson	D7/602
D708,018	S *	7/2014	Carlson	D7/602
D717,120	S *	11/2014	Carlson	D7/602
D717,121	S *	11/2014	Carlson	D7/602
D735,534	S *	8/2015	Berlepsch	D7/545
D756,769	S *	5/2016	Tuchrelo	D9/425
D764,871	S *	8/2016	Touchet	D7/545
D829,037	S *	9/2018	Garcia Luna	D7/360
D830,131	S *	10/2018	Kim	D7/602
D835,465	S *	12/2018	Son	D7/545
2015/0232242	A1 *	8/2015	Carlson	B65D 53/02 220/367.1

* cited by examiner

FIG. 1

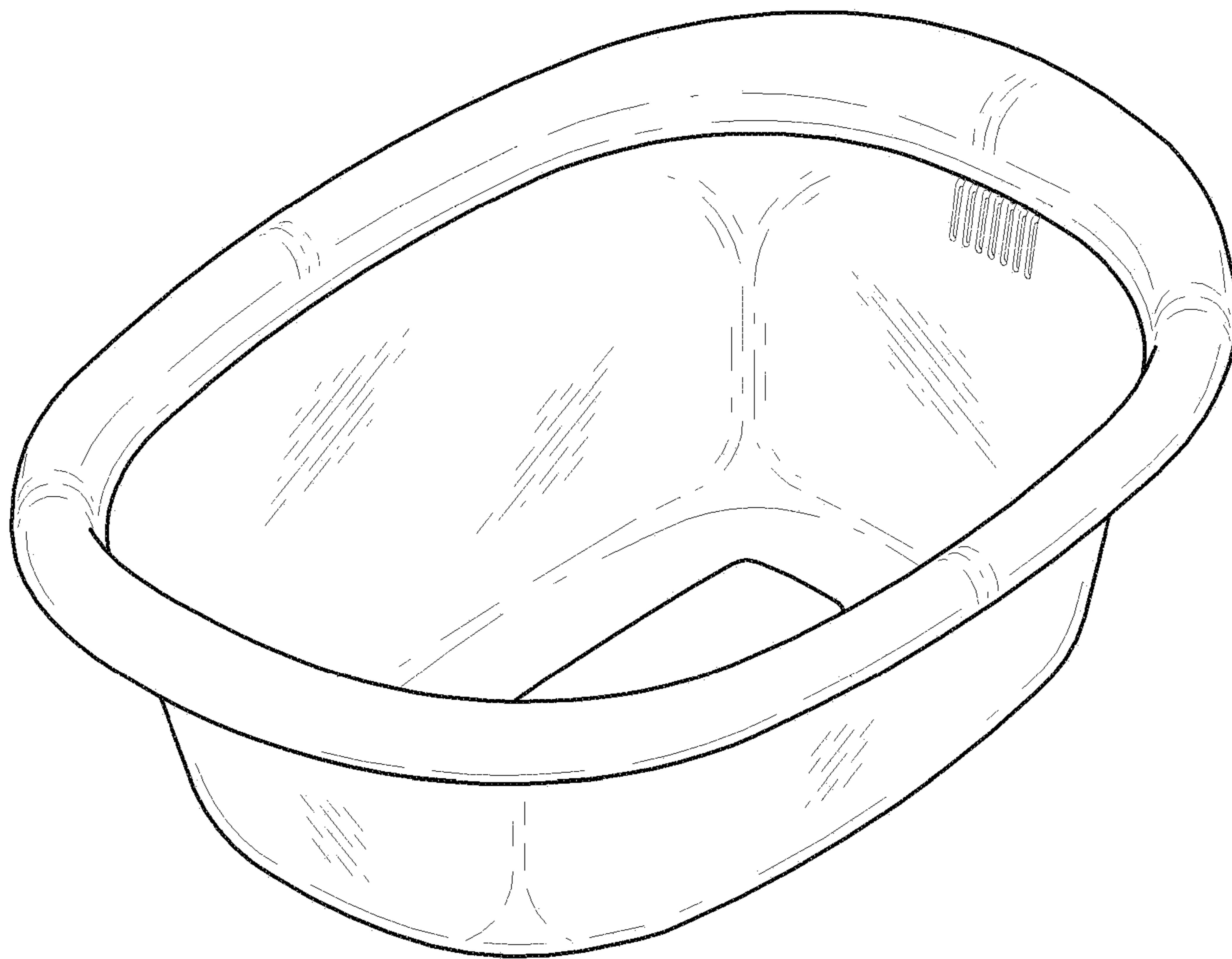

FIG. 2

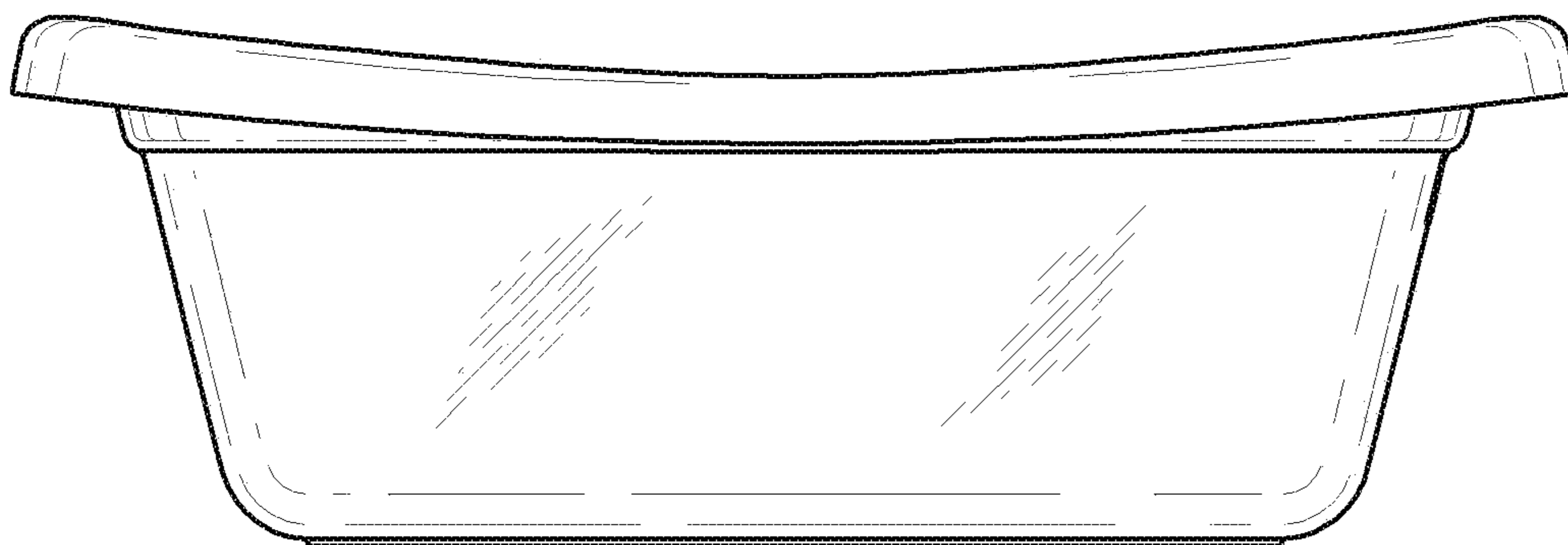

FIG. 3

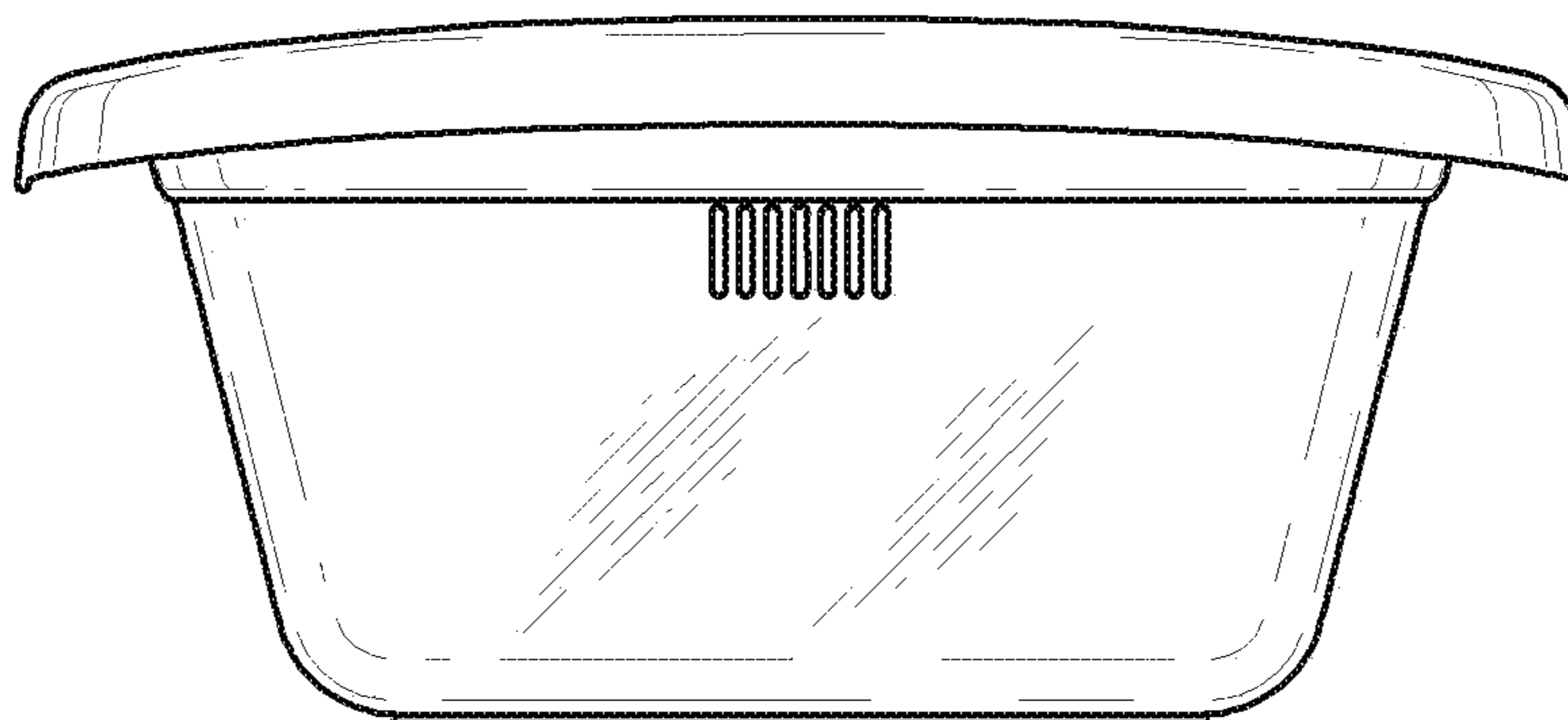

FIG. 4

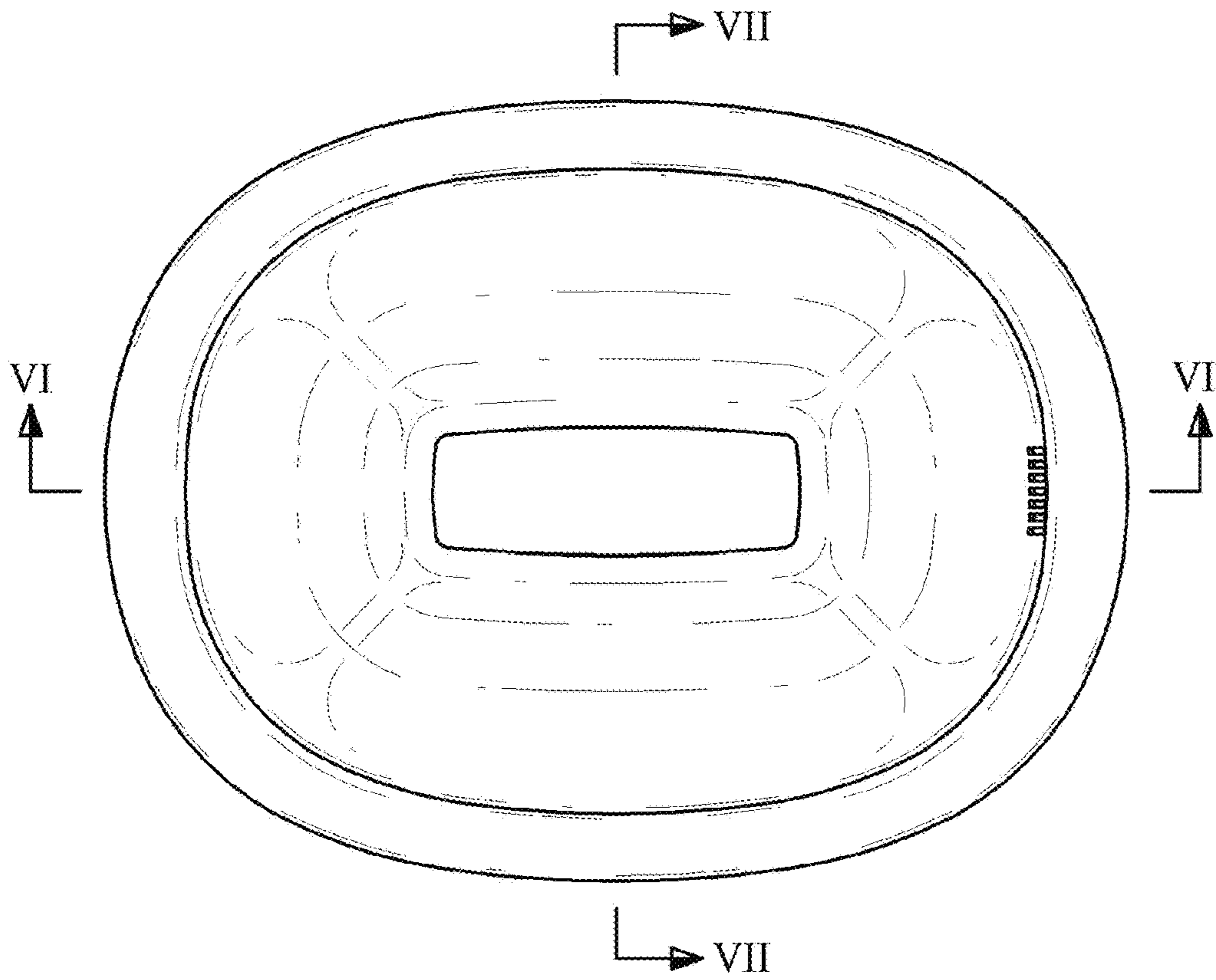

FIG. 5

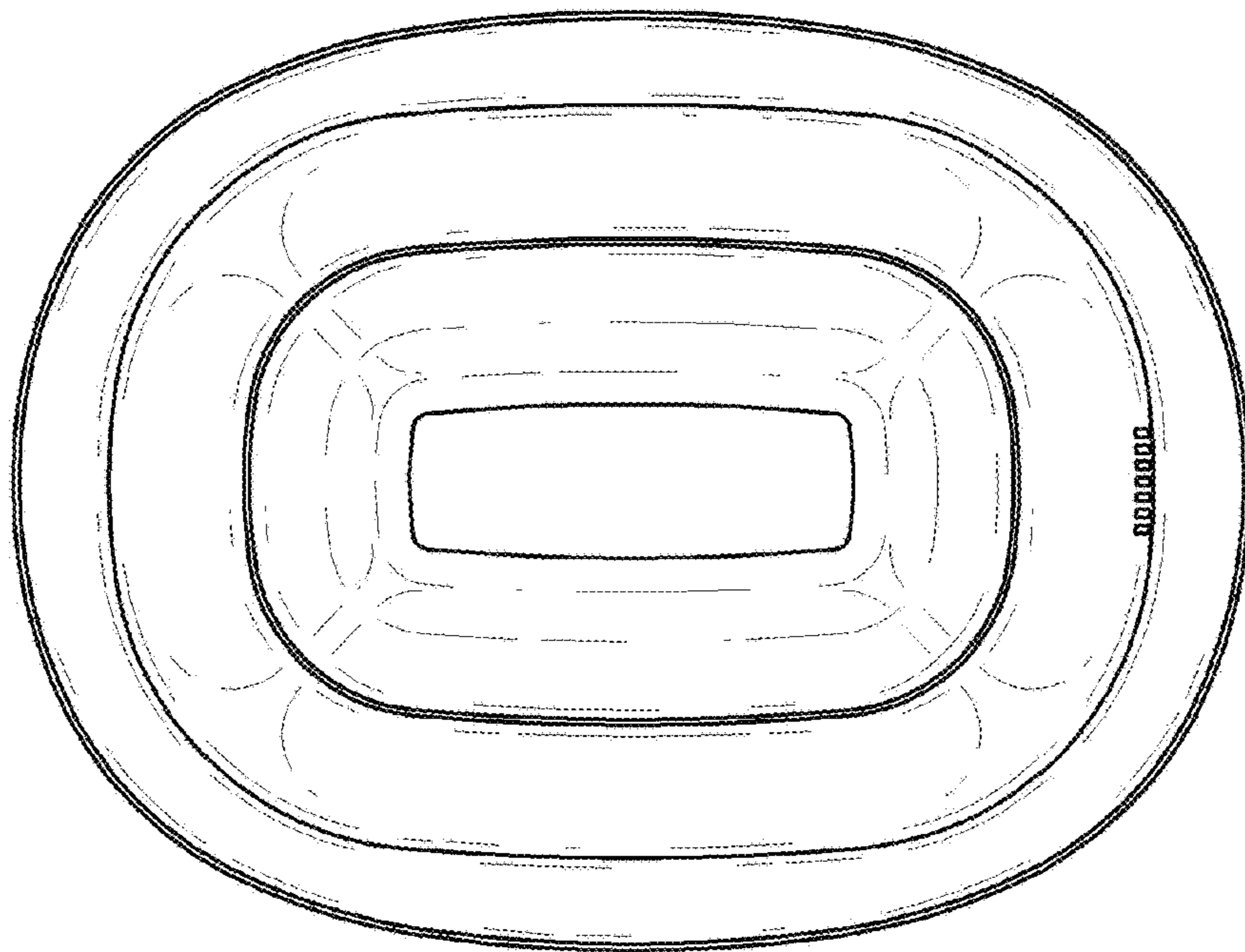

FIG. 6

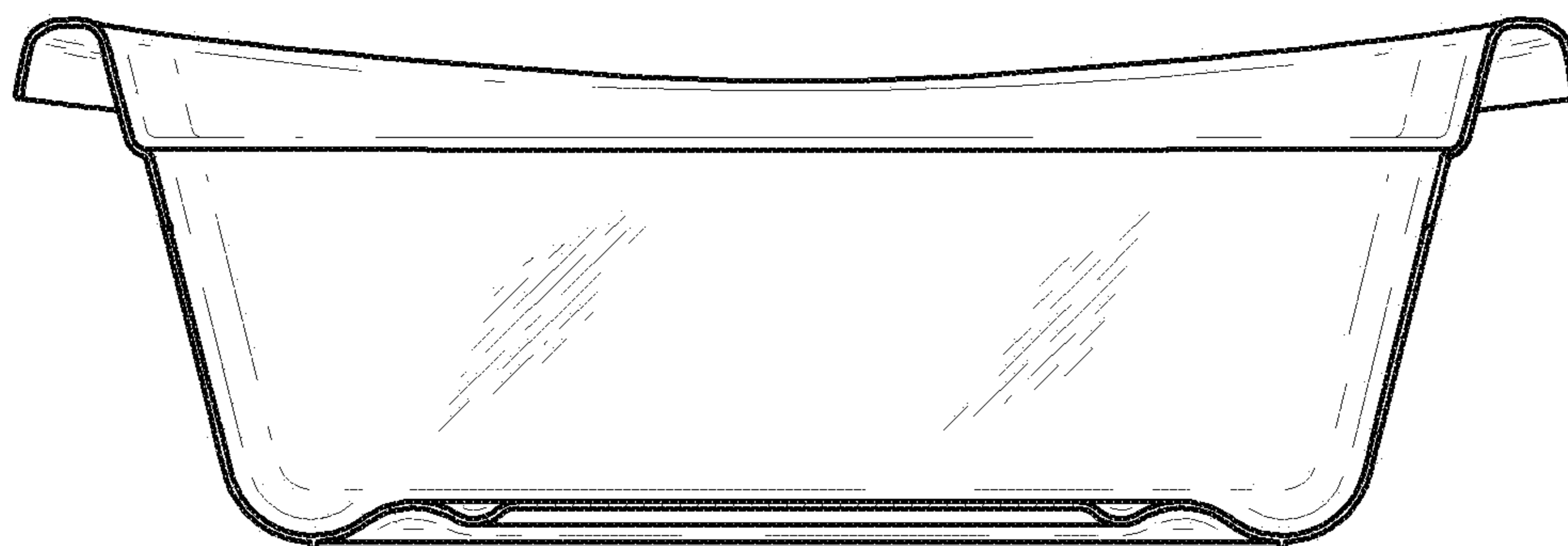

FIG. 7

