



US00D854834S

(12) **United States Design Patent** (10) **Patent No.:** **US D854,834 S**
Altmann et al. (45) **Date of Patent:** **** Jul. 30, 2019**

(54) **TOOTHBRUSH HEAD**

(71) Applicant: **Braun GmbH**, Kronberg (DE)

(72) Inventors: **Niclas Altmann**, Niddatal (DE); **Anke Renz**, Schwalbach (DE); **Bianka Becker-Salzsäuler**, Liederbach (DE); **Heidrun Schmelcher**, Oberursel (DE); **Fritz Schubert**, Bad Camberg (DE); **Ulrich Störkel**, Bad Nauheim (DE)

(73) Assignee: **BRAUN GMBH**, Kronberg (DE)

(**) Term: **15 Years**

(21) Appl. No.: **29/606,819**

(22) Filed: **Jun. 7, 2017**

(51) **LOC (11) Cl.** **04-02**

(52) **U.S. Cl.**

USPC **D4/101; D4/111**

(58) **Field of Classification Search**

USPC **D1/106, 199; D4/100-104, 108-111, D4/127, 128, 132-136, 138, 199; D8/61;**

(Continued)

(56) **References Cited**

U.S. PATENT DOCUMENTS

D354,168 S * 1/1995 Hartwein D13/108
D476,156 S * 6/2003 Ferber D4/101

(Continued)

Primary Examiner — Philip S Hyder

Assistant Examiner — Cary M Robinson

(74) *Attorney, Agent, or Firm* — Vladimir Vitenberg

(57) **CLAIM**

The ornamental design for a toothbrush head, as shown and described.

DESCRIPTION

FIG. 1 is a perspective view of a first embodiment of a toothbrush head;

FIG. 2 is a front view thereof;
FIG. 3 is a right side view thereof;
FIG. 4 is a rear view thereof;
FIG. 5 is a left side view thereof;
FIG. 6 is a top plan view thereof;
FIG. 7 is a bottom view thereof.
FIG. 8 is a perspective view of a second embodiment of a toothbrush head;
FIG. 9 is a front view thereof;
FIG. 10 is a right side view thereof;
FIG. 11 is a rear view thereof;
FIG. 12 is a left side view thereof;
FIG. 13 is a top plan view thereof;
FIG. 14 is a bottom view thereof.
FIG. 15 is a perspective view of a third embodiment of a toothbrush head;
FIG. 16 is a front view thereof;
FIG. 17 is a right side view thereof;
FIG. 18 is a rear view thereof;
FIG. 19 is a left side view thereof;
FIG. 20 is a top plan view thereof;
FIG. 21 is a bottom view thereof.
FIG. 22 is a perspective view of a fourth embodiment of a toothbrush head;
FIG. 23 is a front view thereof;
FIG. 24 is a right side view thereof;
FIG. 25 is a rear view thereof;
FIG. 26 is a left side view thereof;
FIG. 27 is a top plan view thereof;
FIG. 28 is a bottom view thereof.
FIG. 29 is a perspective view of a fifth embodiment of a toothbrush head;
FIG. 30 is a front view thereof;
FIG. 31 is a right side view thereof;
FIG. 32 is a rear view thereof;
FIG. 33 is a left side view thereof;
FIG. 34 is a top plan view thereof;
FIG. 35 is a bottom view thereof.
FIG. 36 is a perspective view of a sixth embodiment of a toothbrush head;
FIG. 37 is a front view thereof;
FIG. 38 is a right side view thereof;
FIG. 39 is a rear view thereof;

(Continued)

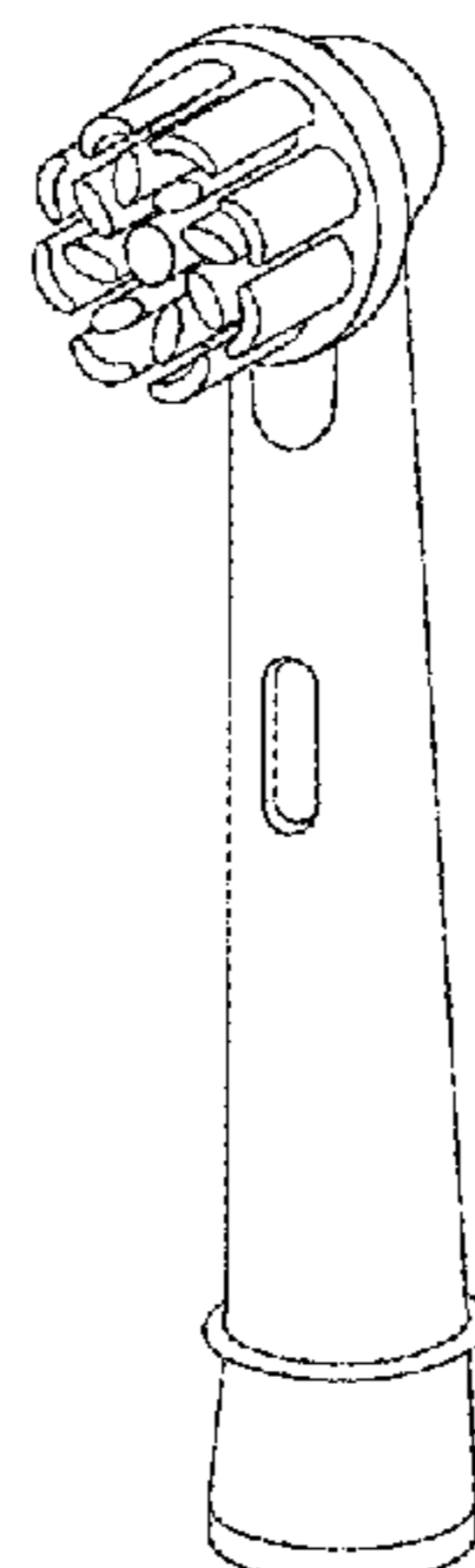

FIG. 40 is a left side view thereof;
 FIG. 41 is a top plan view thereof;
 FIG. 42 is a bottom view thereof.
 FIG. 43 is a perspective view of a seventh embodiment of a toothbrush head;
 FIG. 44 is a front view thereof;
 FIG. 45 is a right side view thereof;
 FIG. 46 is a rear view thereof;
 FIG. 47 is a left side view thereof;
 FIG. 48 is a top plan view thereof;
 FIG. 49 is a bottom view thereof.
 FIG. 50 is a perspective view of an eight embodiment of a toothbrush head;
 FIG. 51 is a front view thereof;
 FIG. 52 is a right side view thereof;
 FIG. 53 is a rear view thereof;
 FIG. 54 is a left side view thereof;
 FIG. 55 is a top plan view thereof; and,
 FIG. 56 is a bottom view thereof.
 The broken lines in the drawings illustrate portions of the toothbrush head in which the design is embodied that form no part of the claimed design.

1 Claim, 8 Drawing Sheets

(58) **Field of Classification Search**

USPC D13/107, 108; D14/288; D24/119, 146, D24/180; D30/158, 159
 CPC A46B 5/00; A46B 9/04; A46B 9/10; A46B 7/00; A46B 2200/1066; A46B 2200/1073; A46B 2200/1086
 See application file for complete search history.

(56) **References Cited**

U.S. PATENT DOCUMENTS

D480,875	S	*	10/2003	De Salvo	D4/101
D501,605	S	*	2/2005	Brown, Jr.	D4/101
D527,905	S	*	9/2006	Winkler	D4/101
D579,664	S	*	11/2008	Fisher	D4/101
D611,712	S	*	3/2010	Stoerkel	D4/104
D612,611	S	*	3/2010	Brown, Jr.	D4/101
D715,057	S	*	10/2014	Adriaenssen	D4/101
D751,821	S	*	3/2016	Since	D4/101
D758,079	S	*	6/2016	Since	D4/101
D758,080	S	*	6/2016	Since	D4/101
D775,469	S	*	1/2017	Sikora	D4/102
D781,588	S	*	3/2017	Lee	D4/102
D814,195	S	*	4/2018	Sikora	D4/102
D819,974	S	*	6/2018	Johansson	D4/101
D831,358	S	*	10/2018	Altmann	D4/101

* cited by examiner

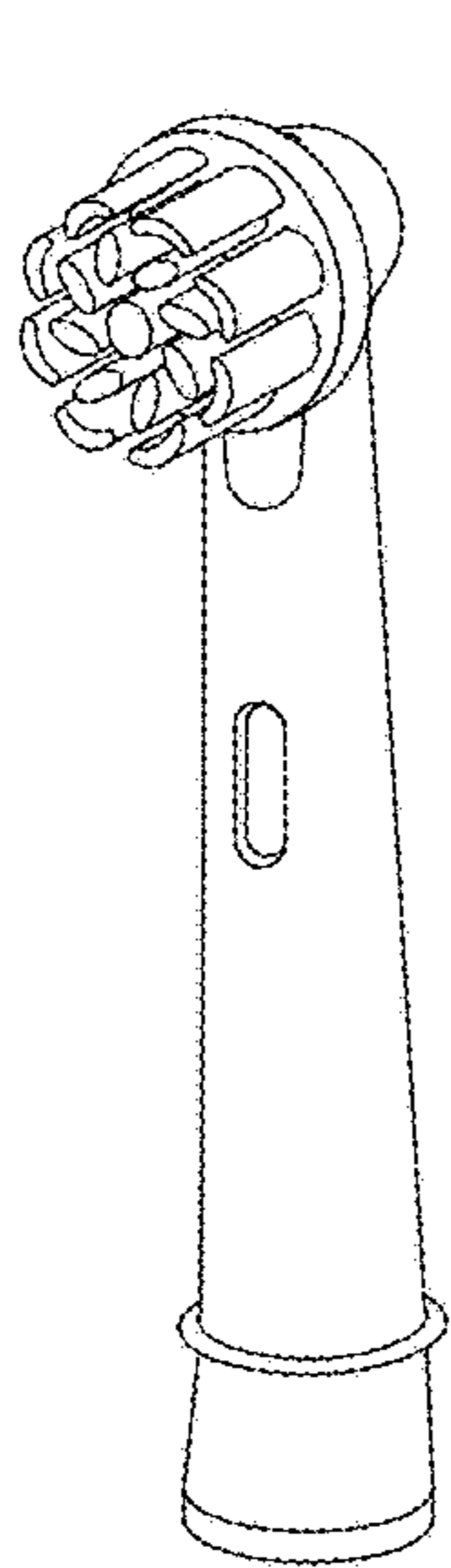

FIG. 1

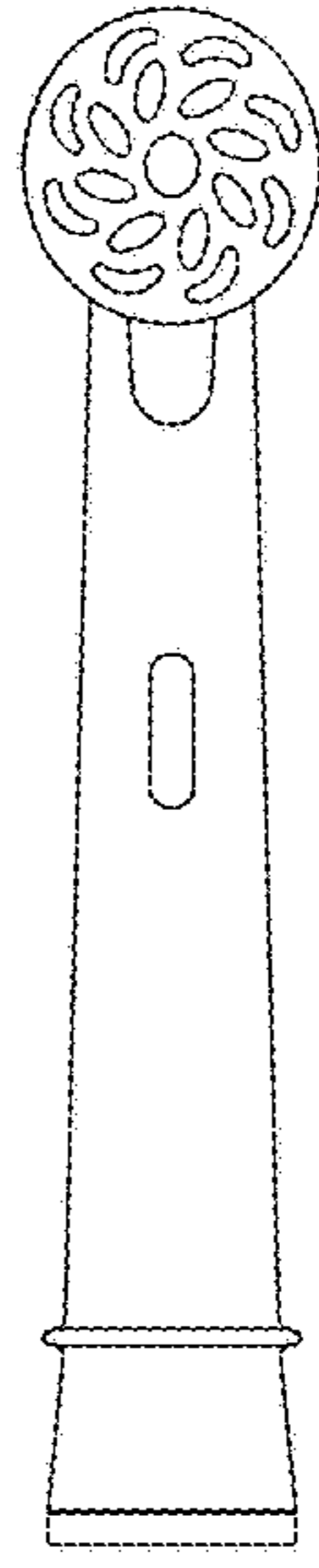

FIG. 2

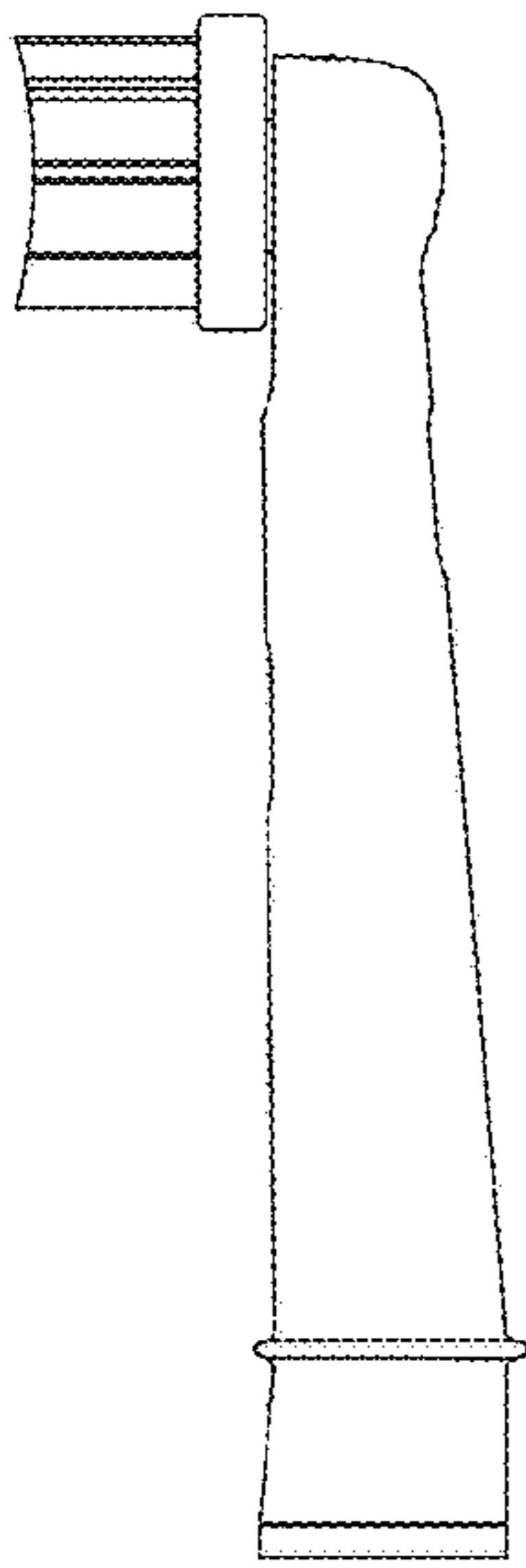

FIG. 3

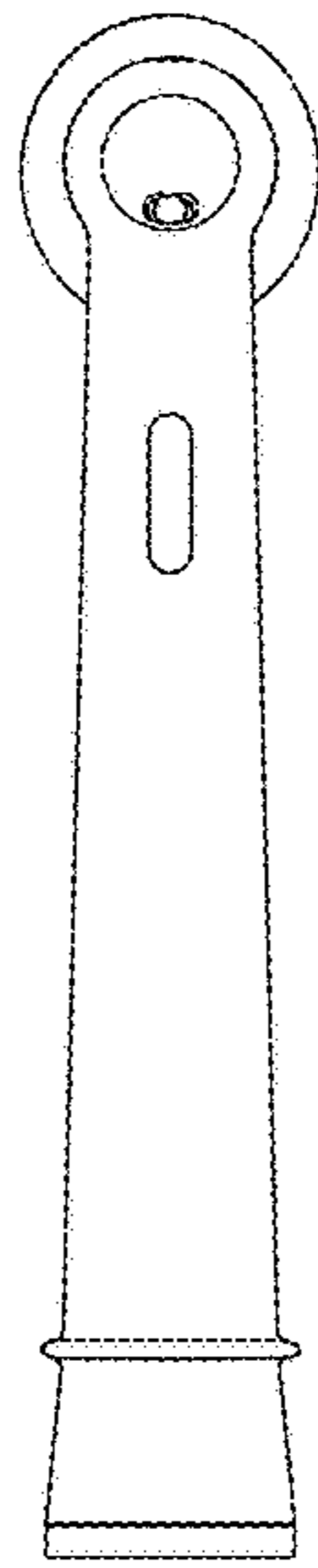

FIG. 4

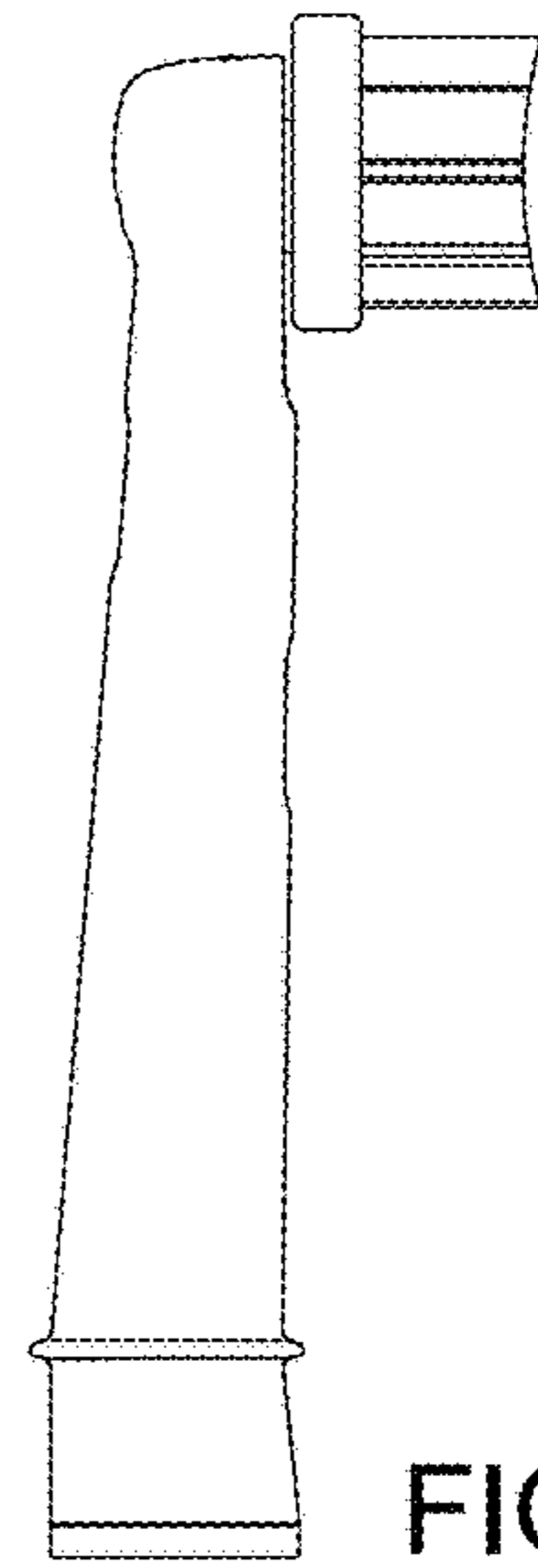

FIG. 5

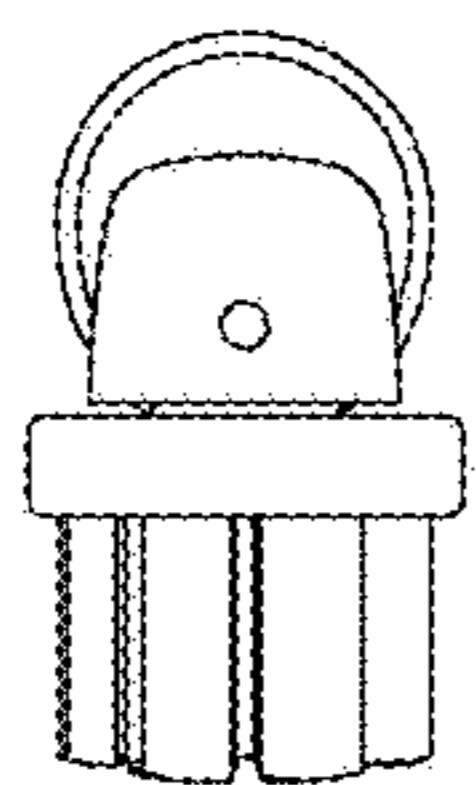

FIG. 6

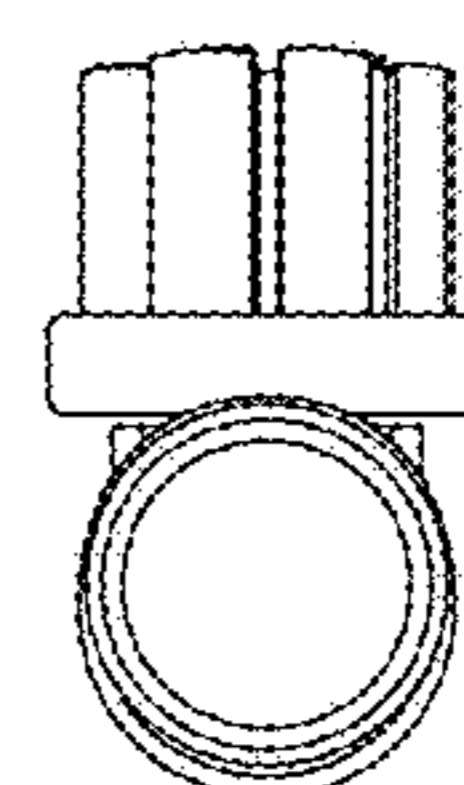

FIG. 7

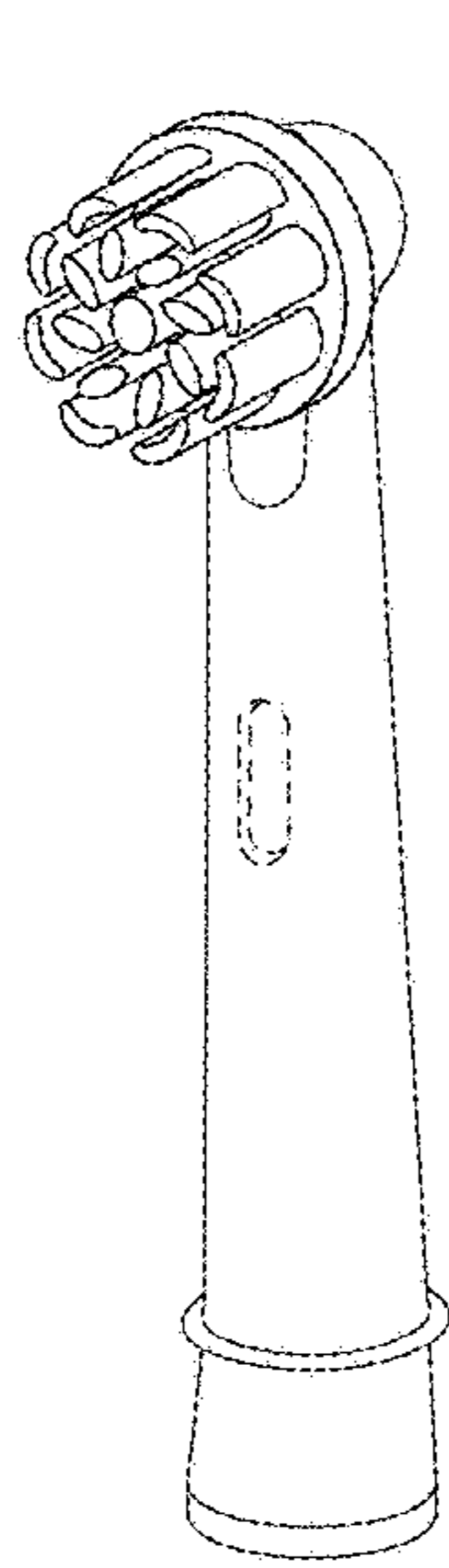

FIG. 8

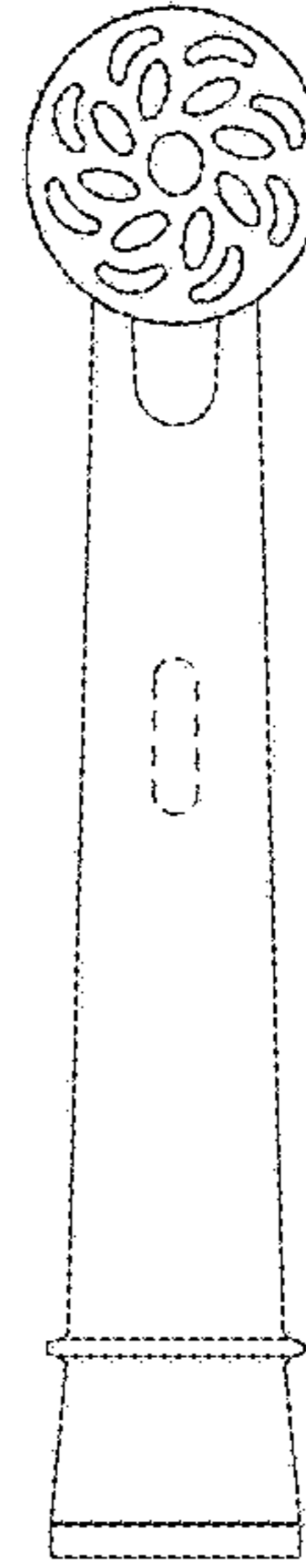

FIG. 9

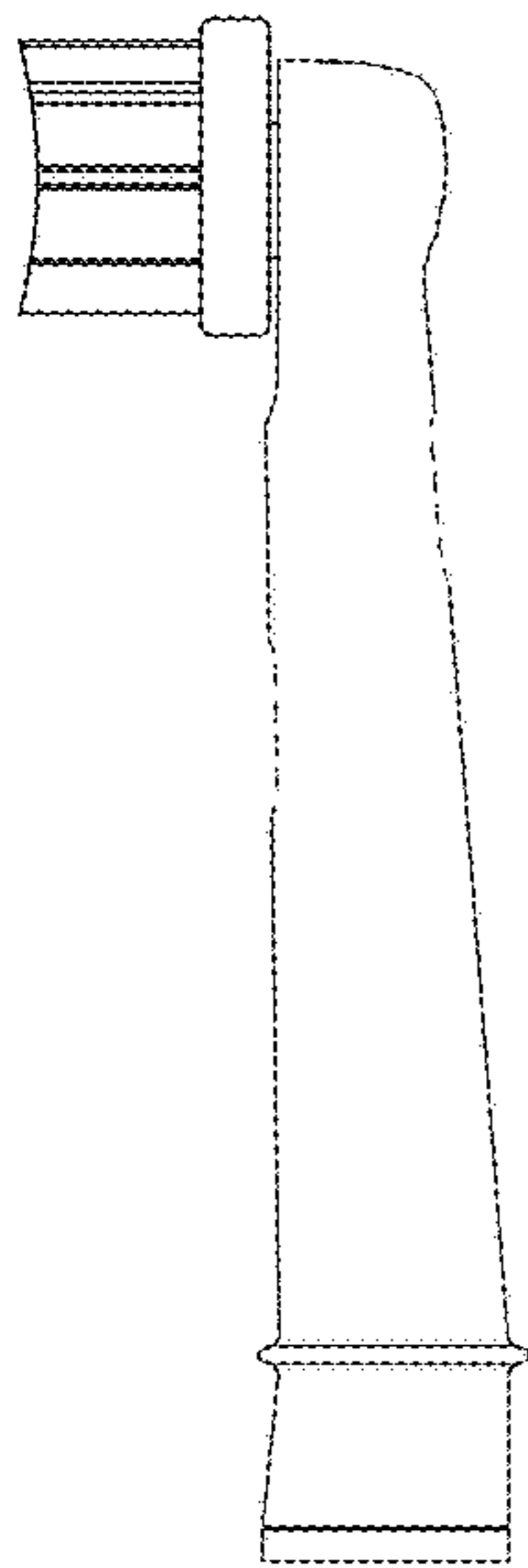

FIG. 10

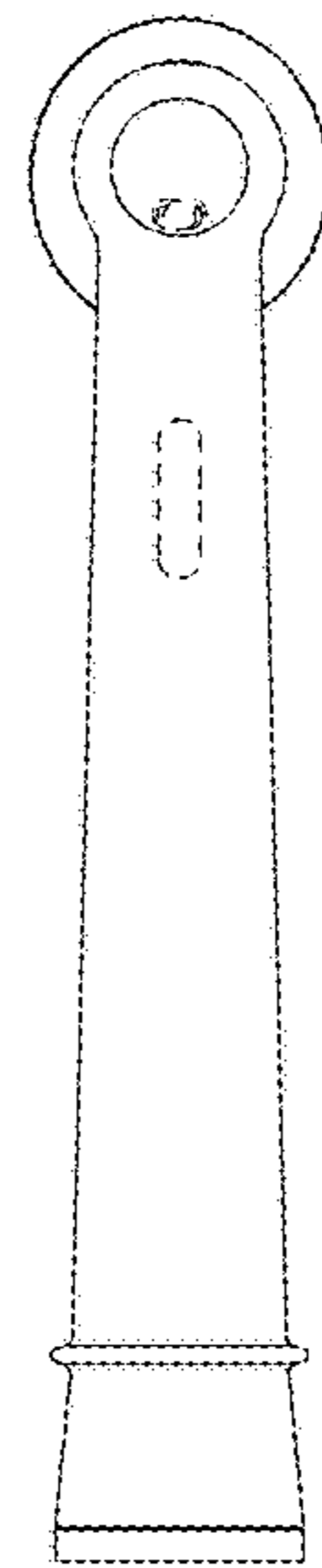

FIG. 11

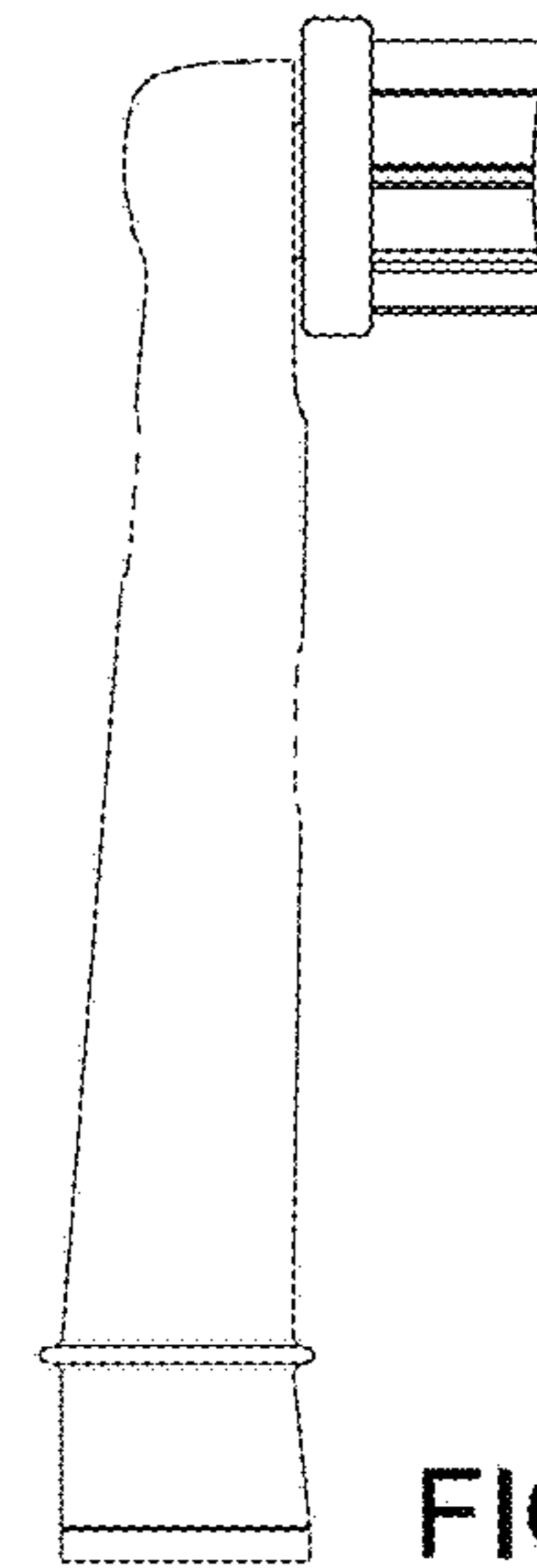

FIG. 12

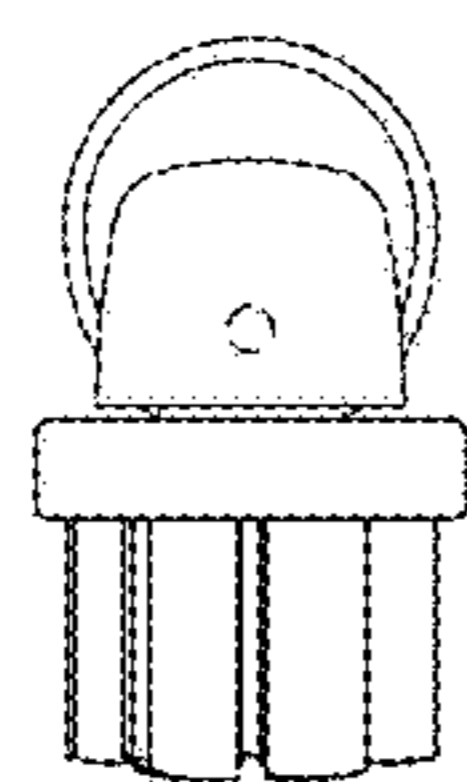

FIG. 13

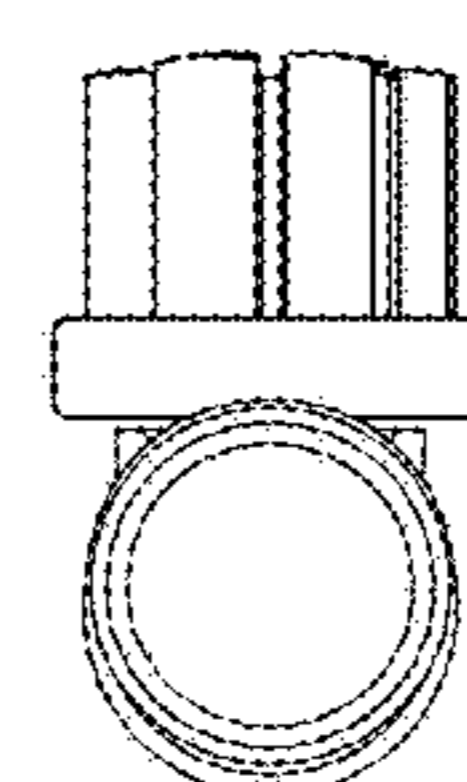

FIG. 14

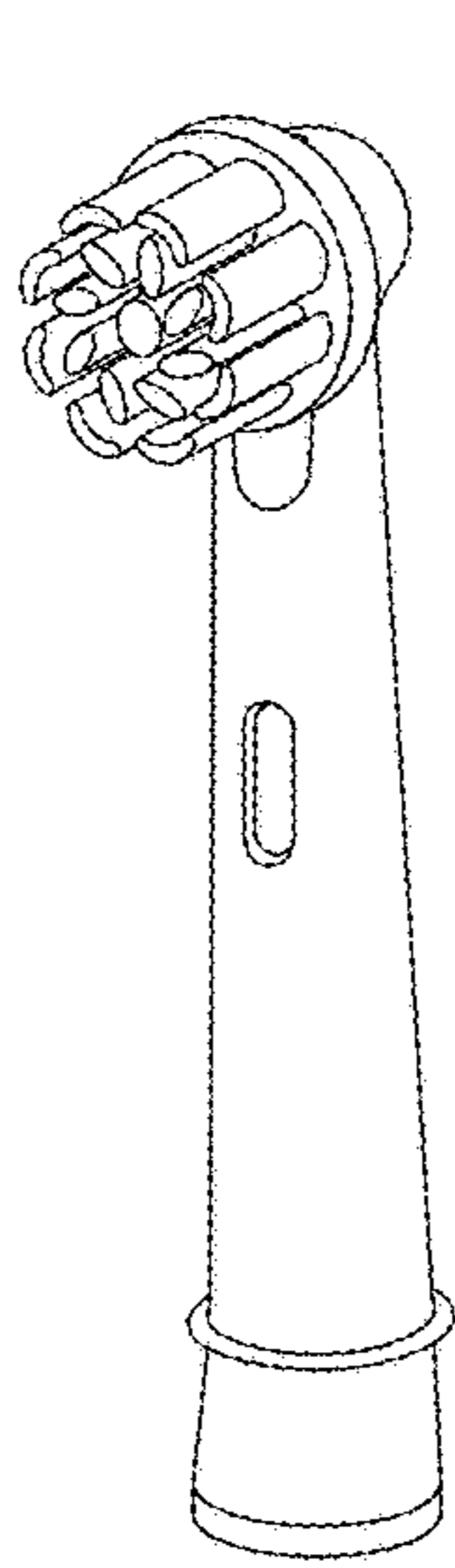

FIG. 15

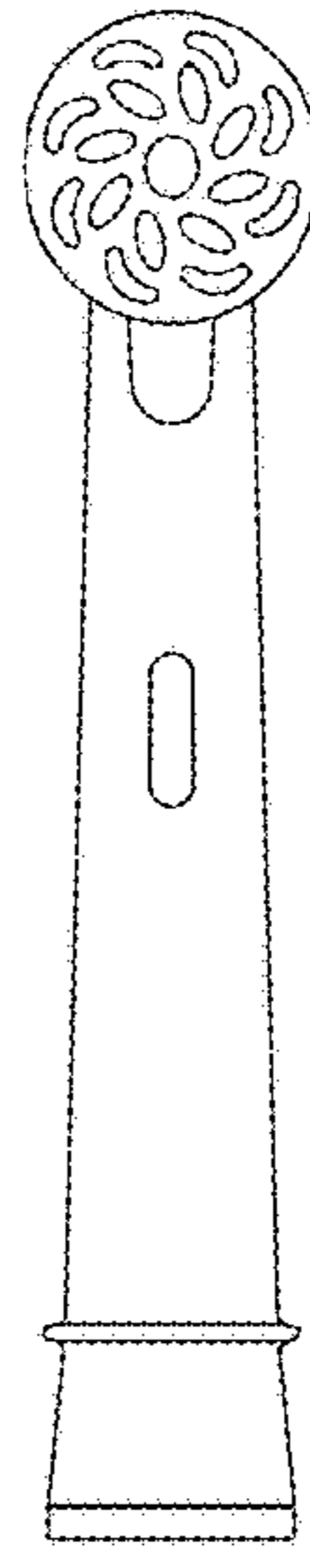

FIG. 16

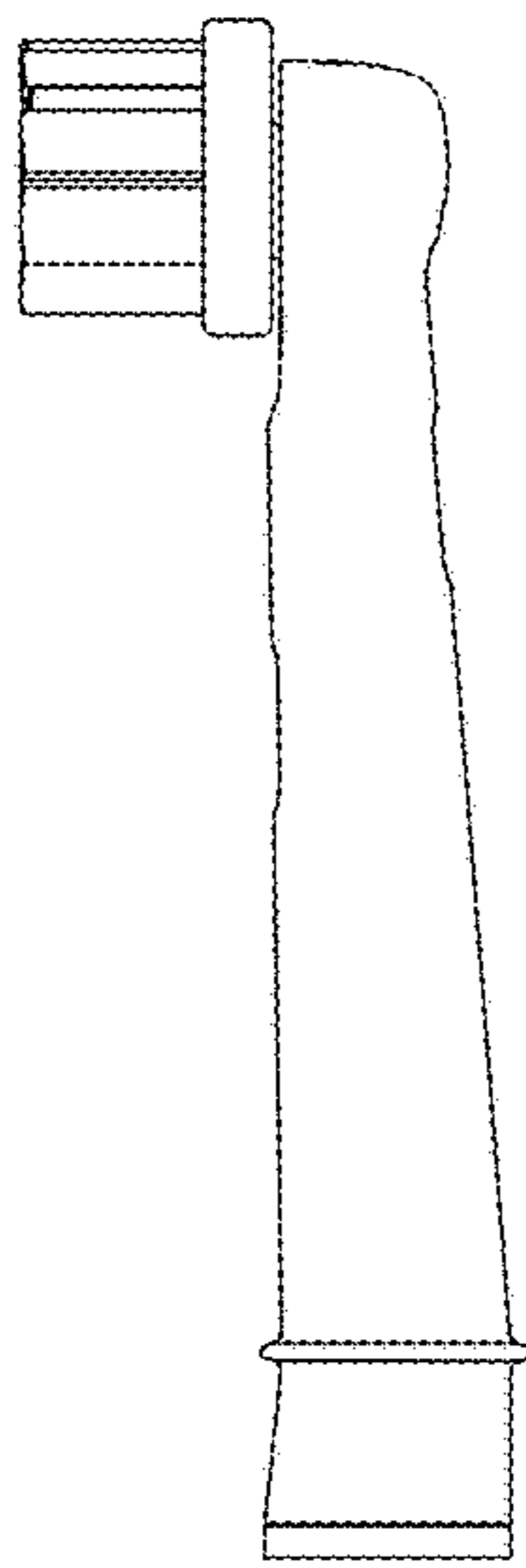

FIG. 17

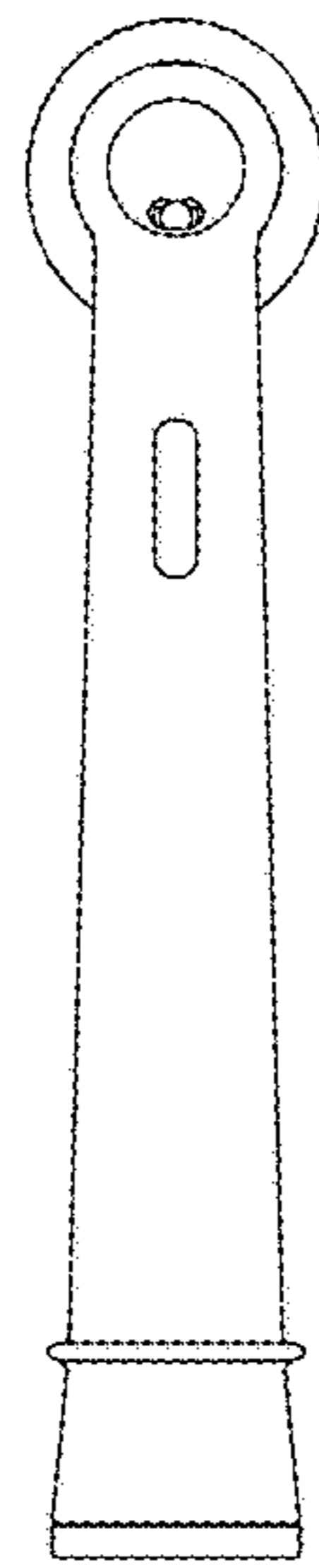

FIG. 18

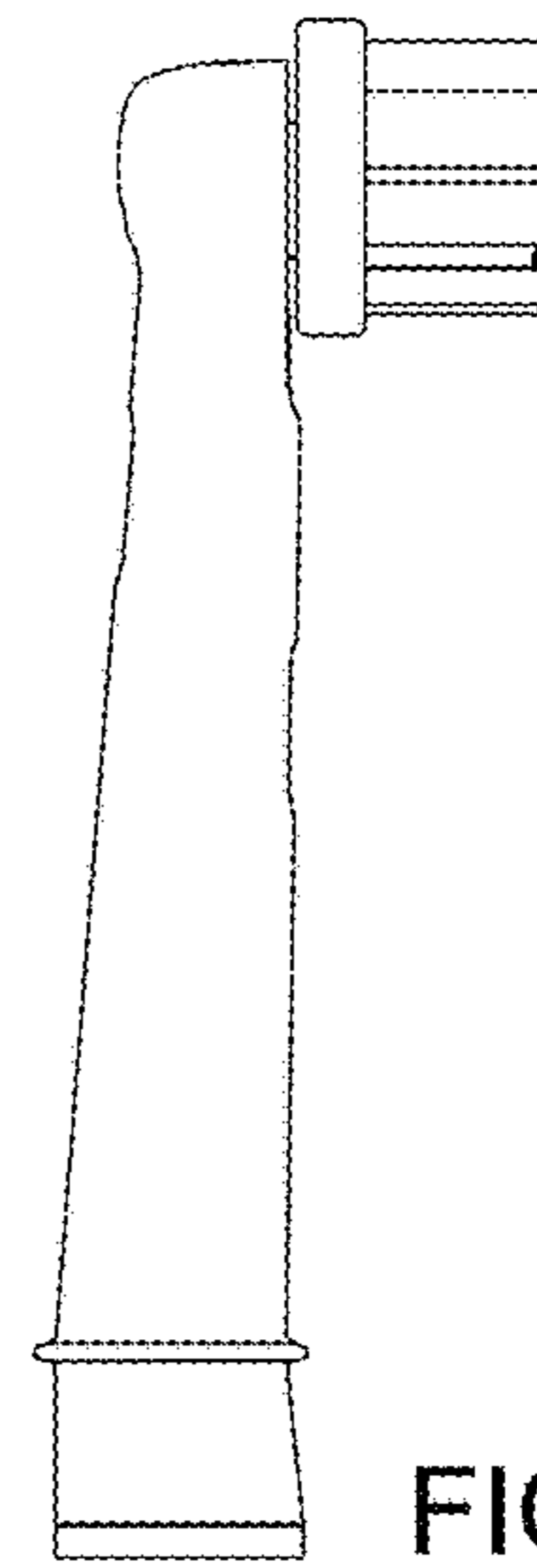

FIG. 19

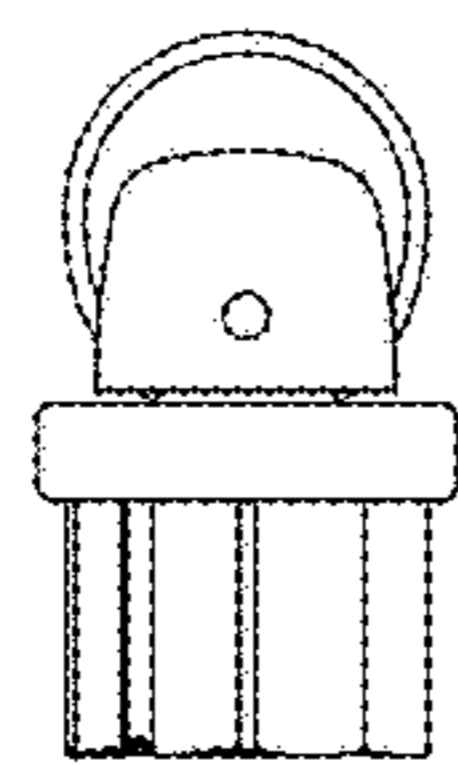

FIG. 20

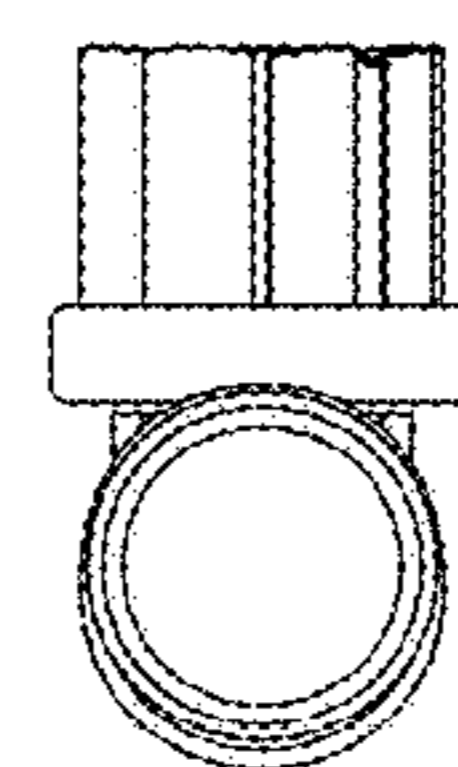

FIG. 21

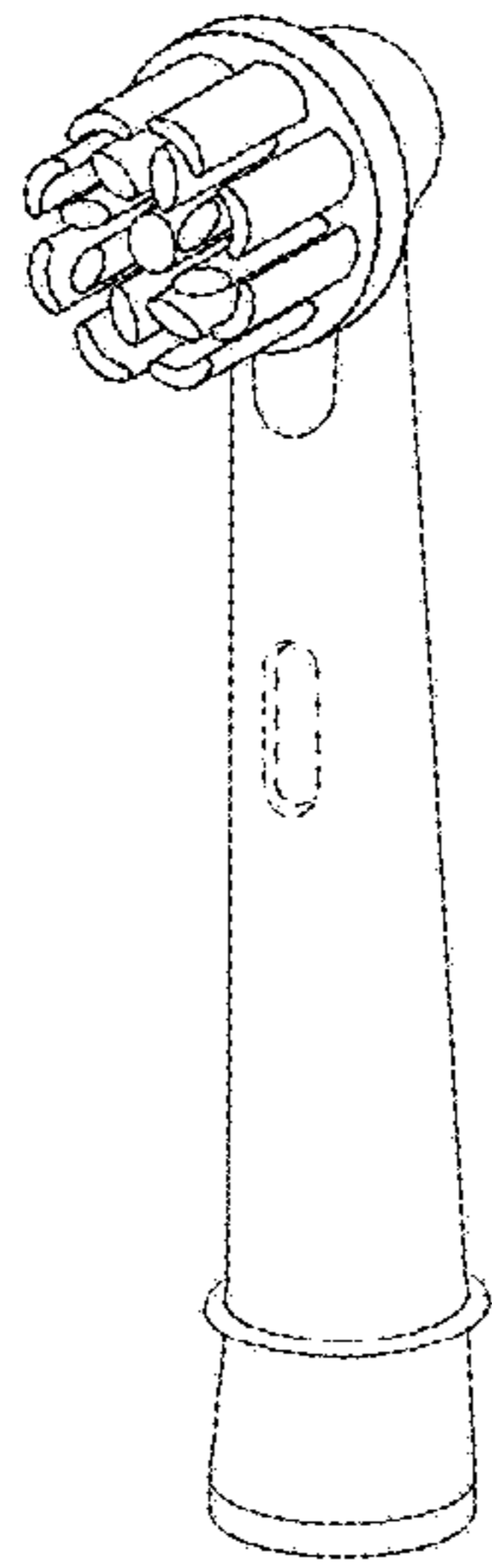

FIG. 22

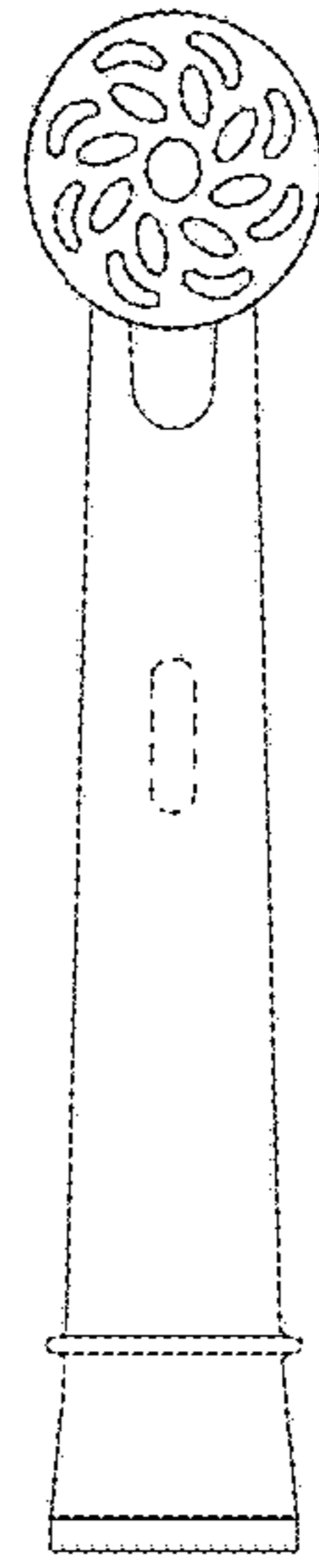

FIG. 23

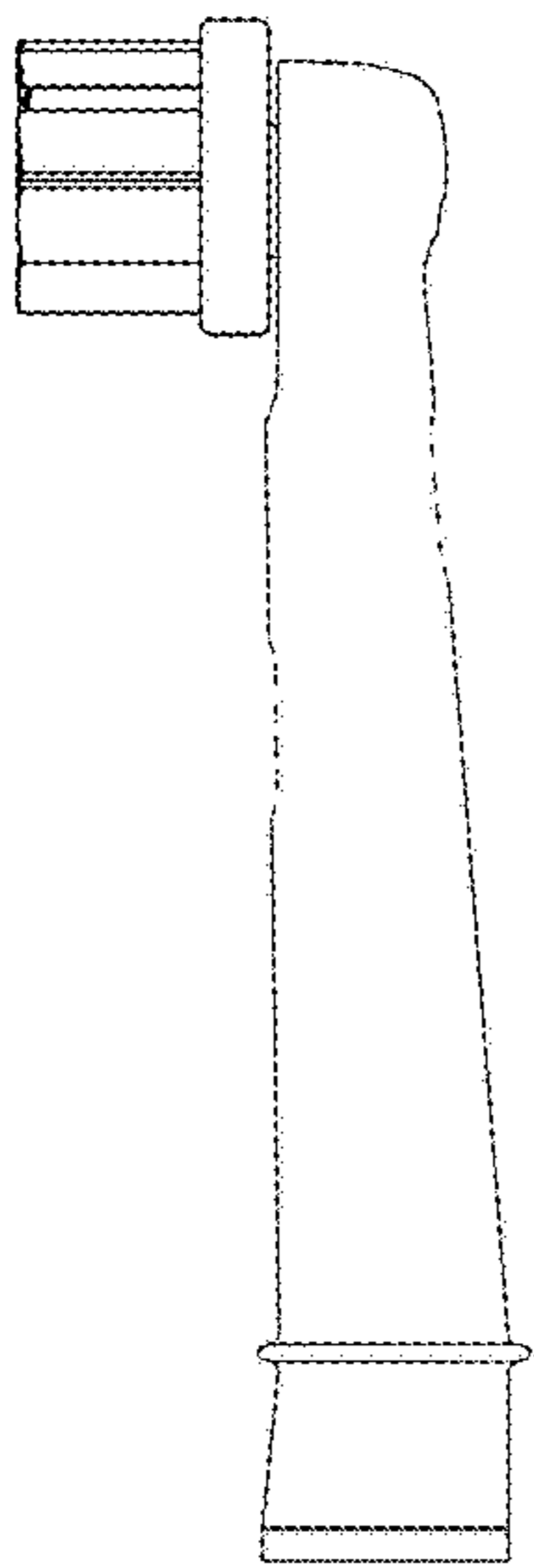

FIG. 24

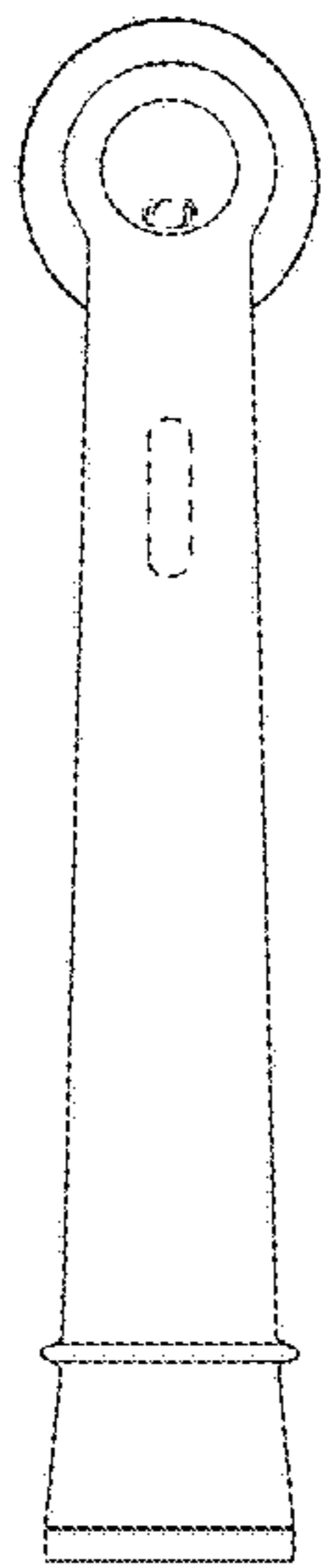

FIG. 25

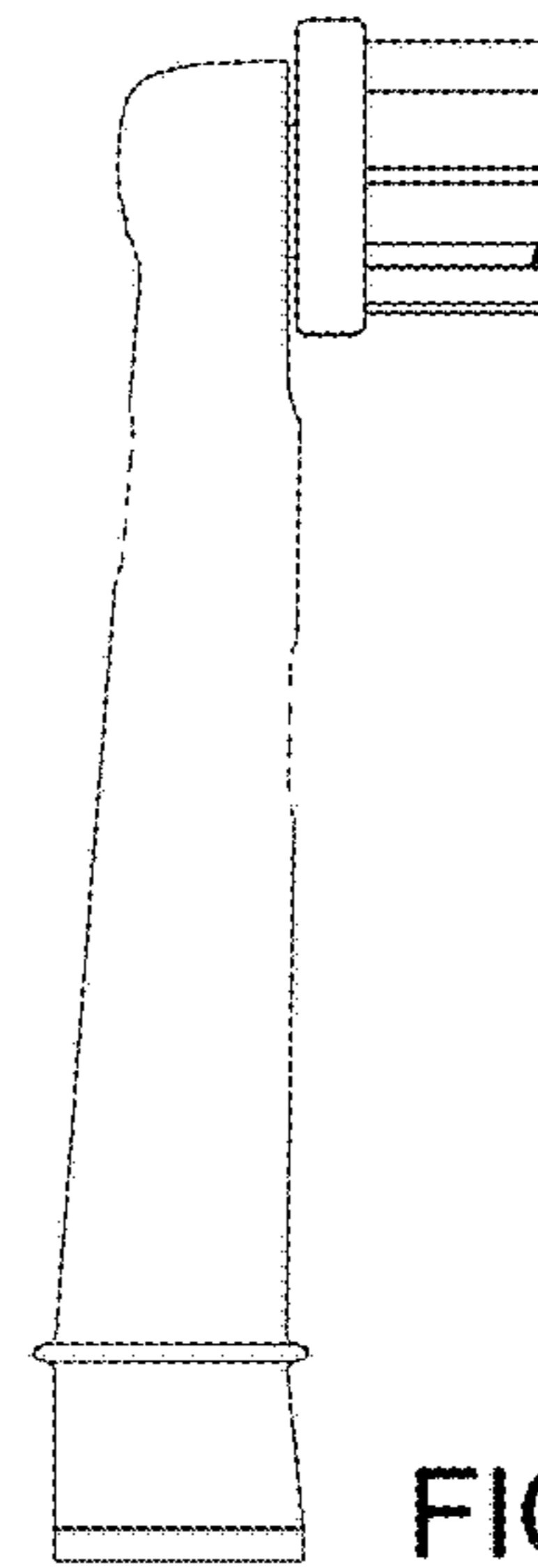

FIG. 26

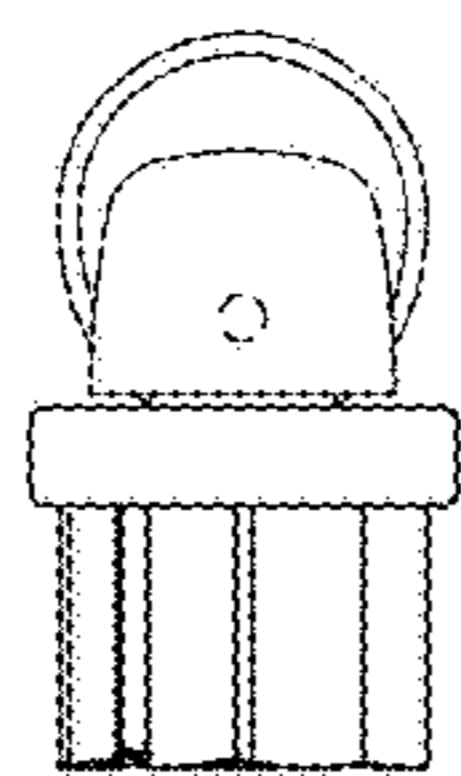

FIG. 27

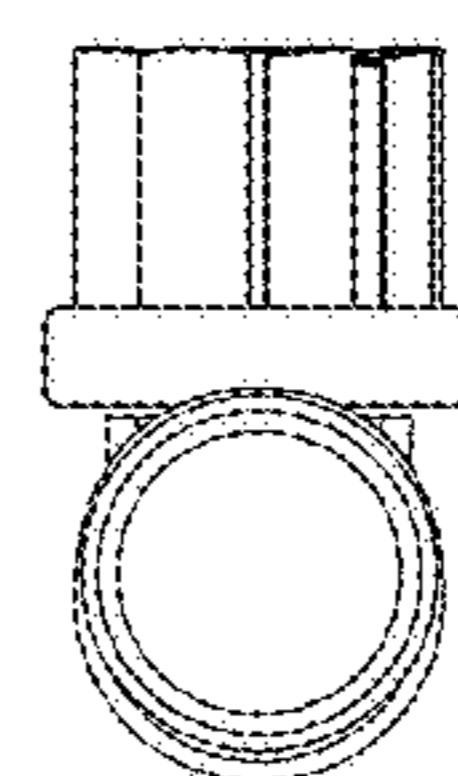

FIG. 28

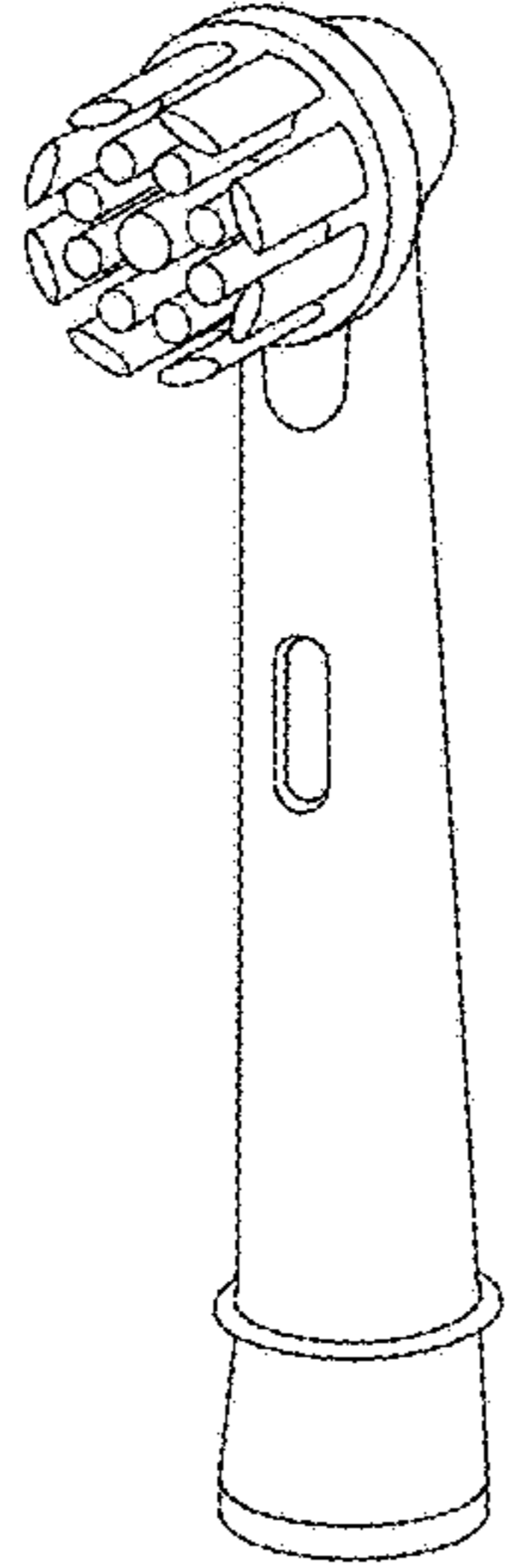

FIG. 29

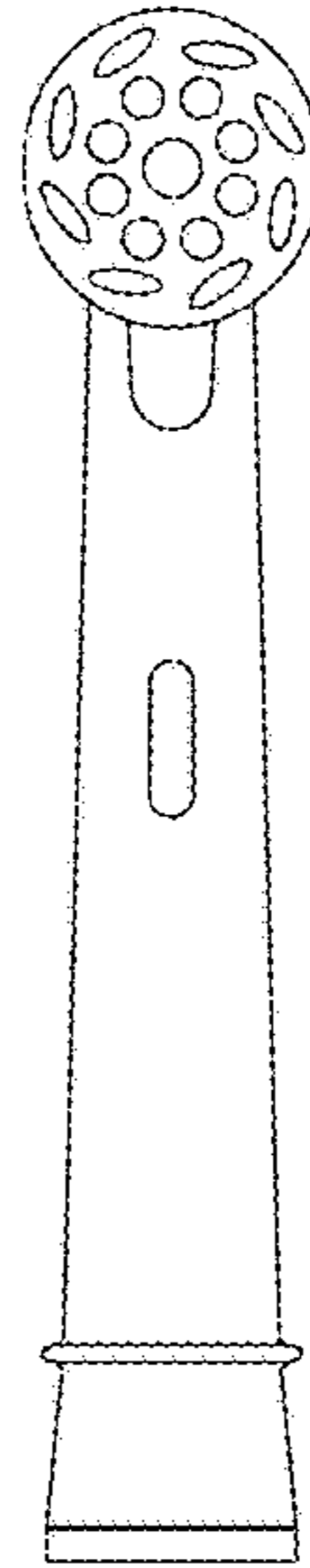

FIG. 30

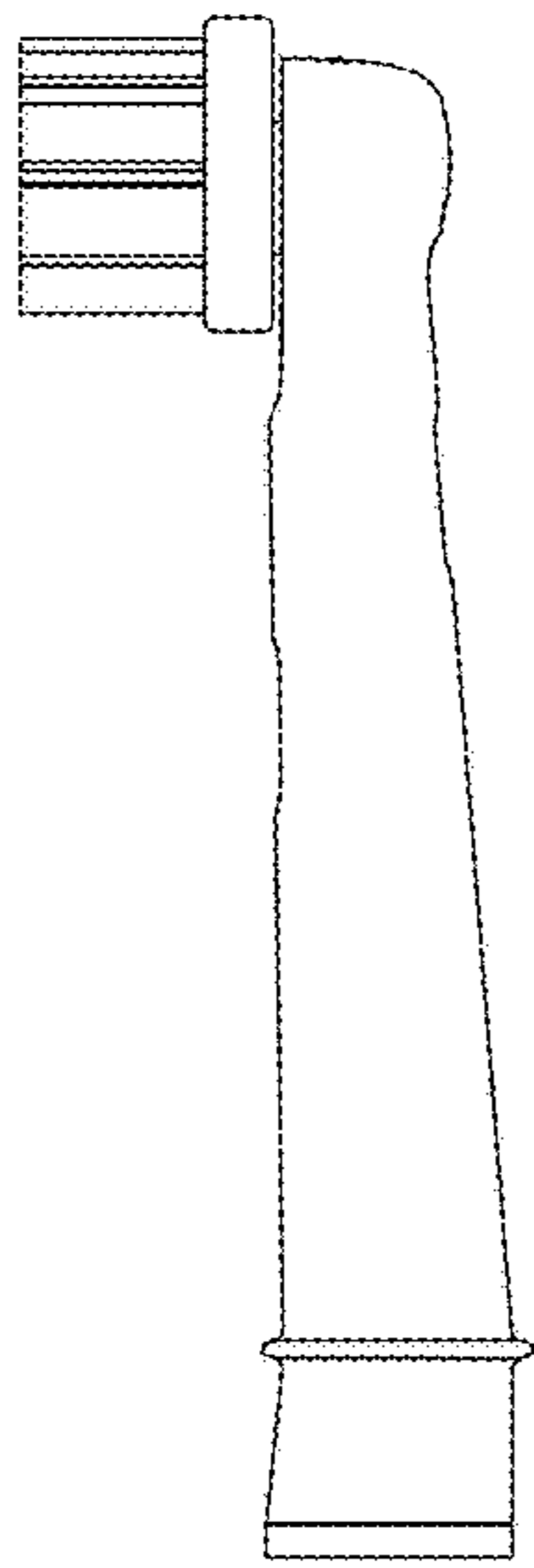

FIG. 31

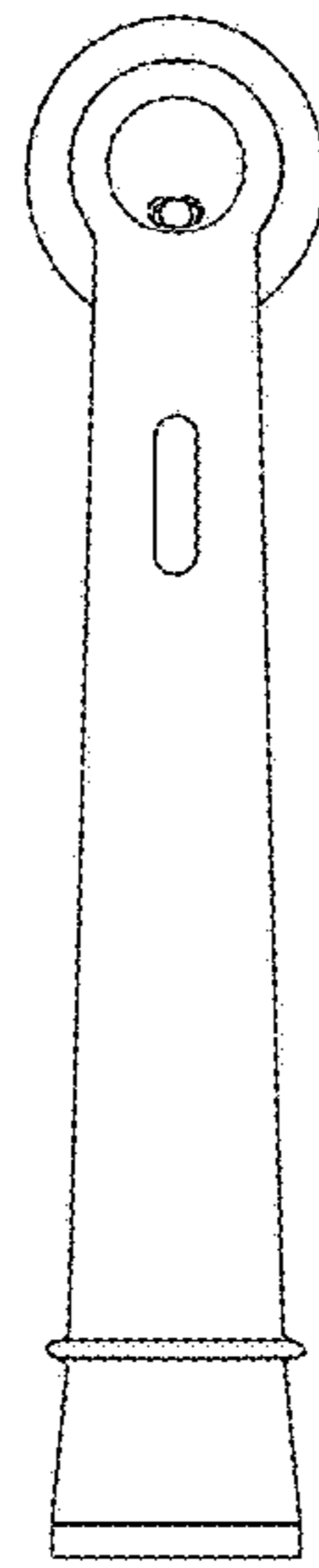

FIG. 32

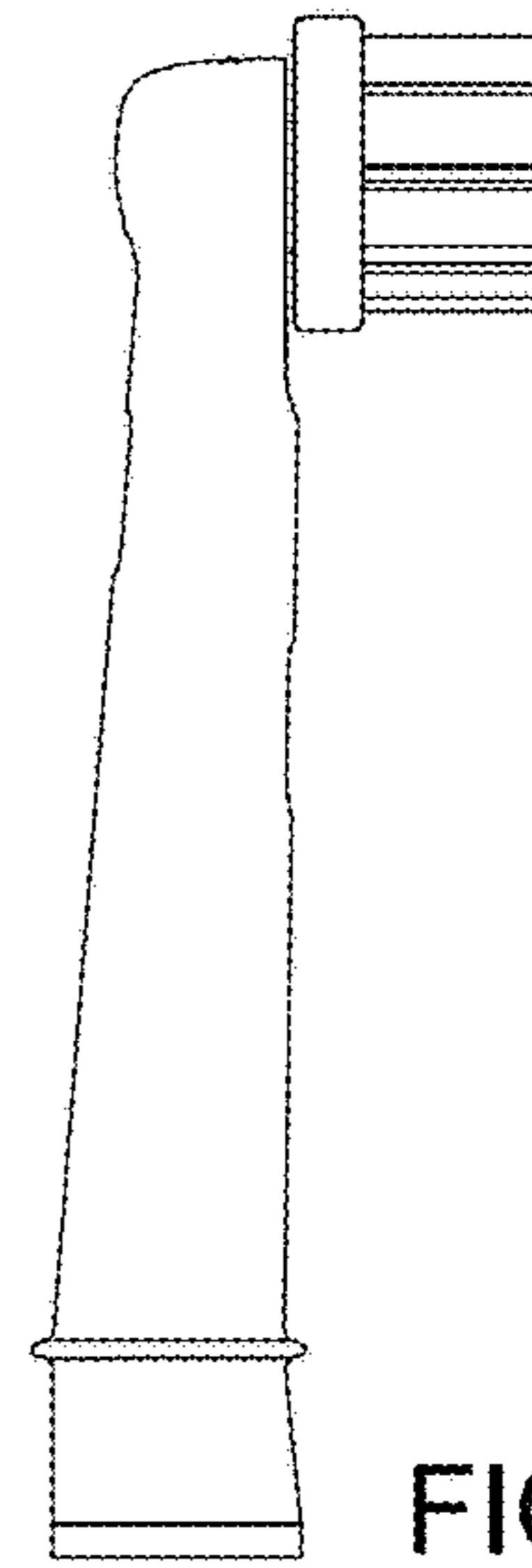

FIG. 33

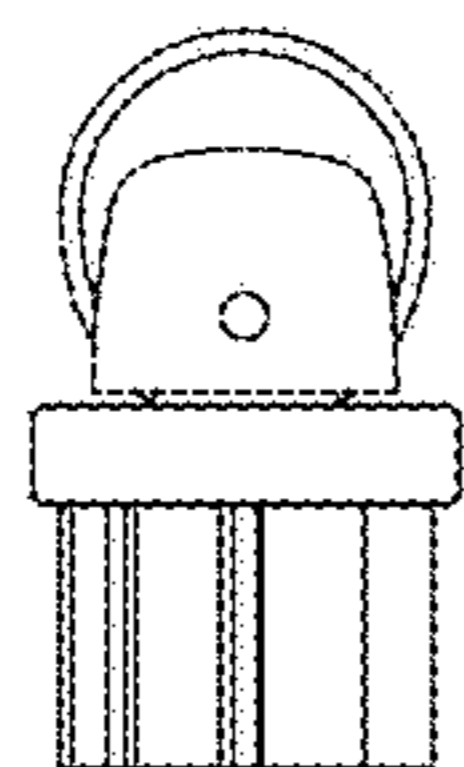

FIG. 34

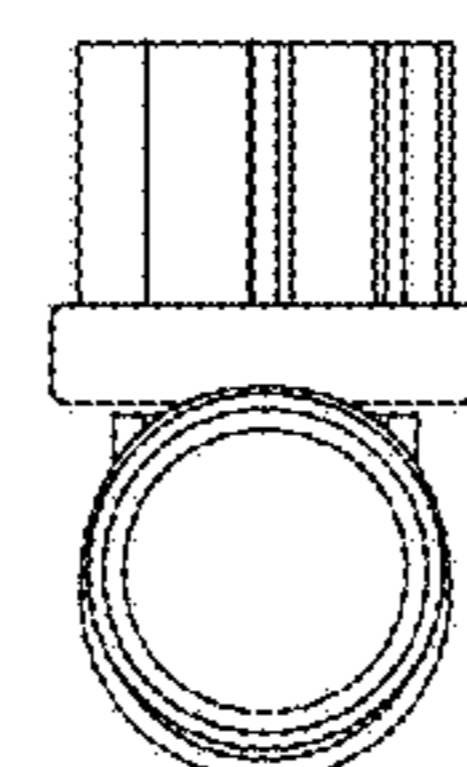

FIG. 35

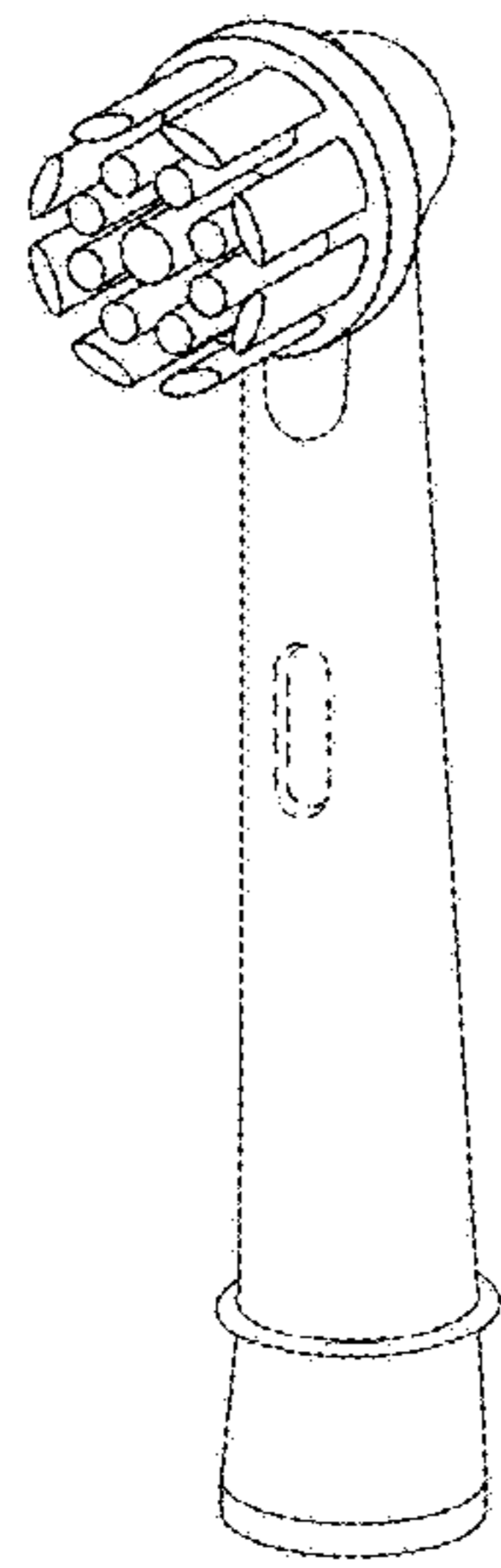

FIG. 36

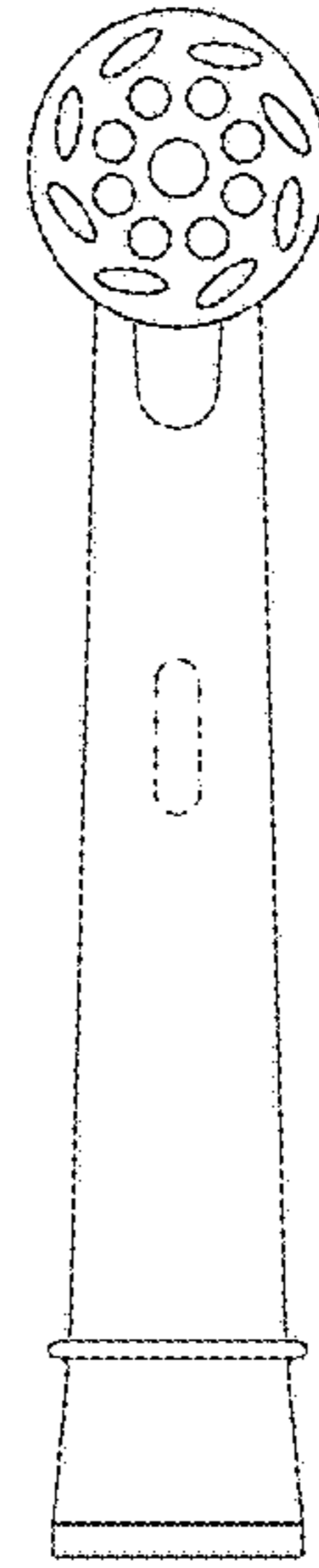

FIG. 37

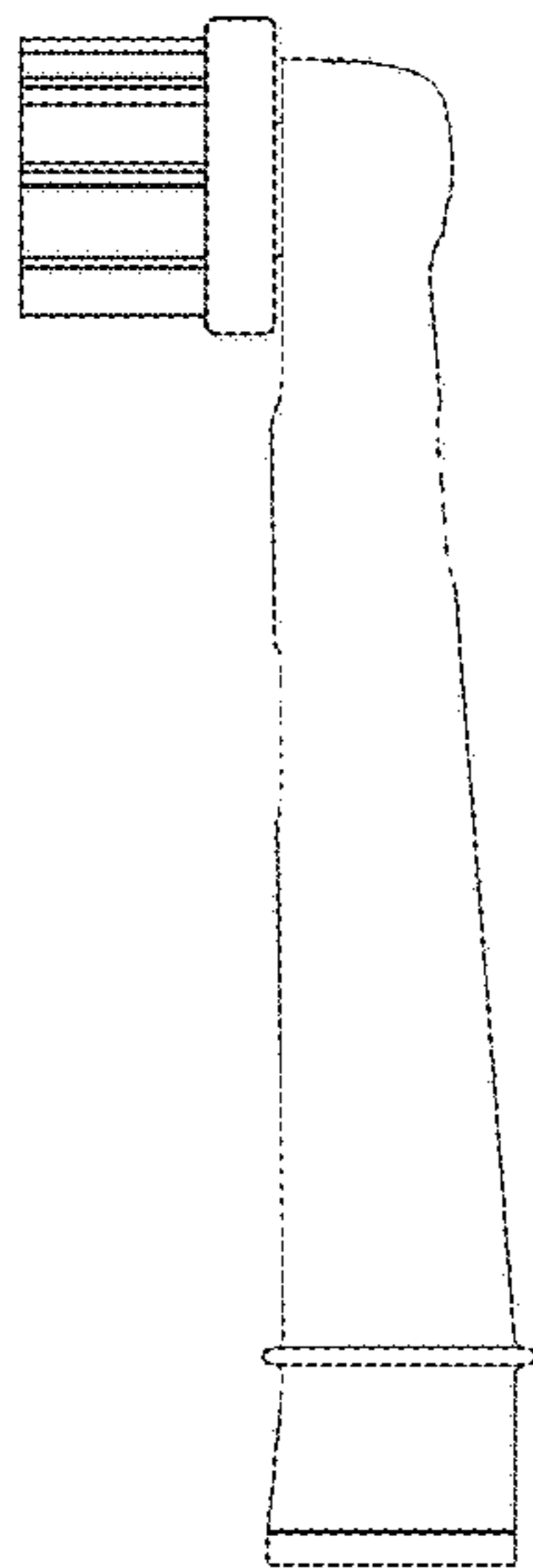

FIG. 38

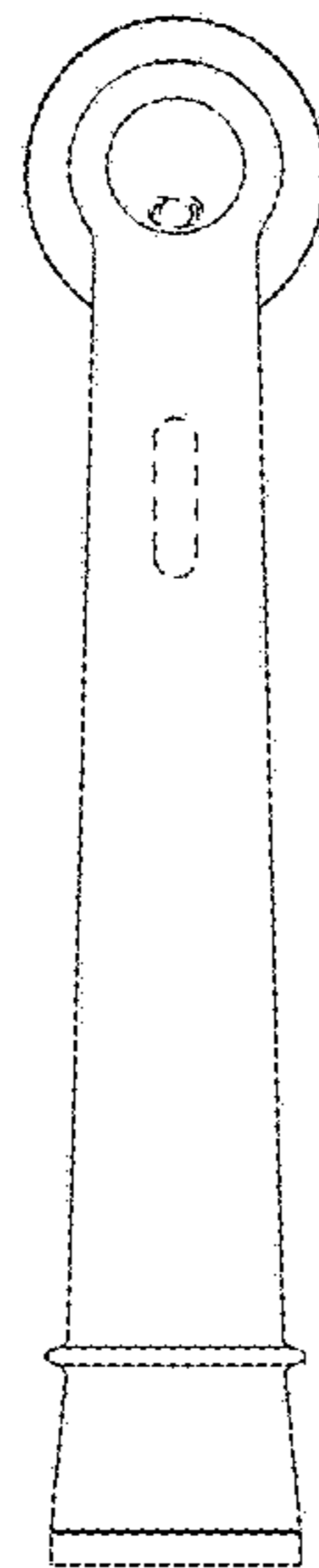

FIG. 39

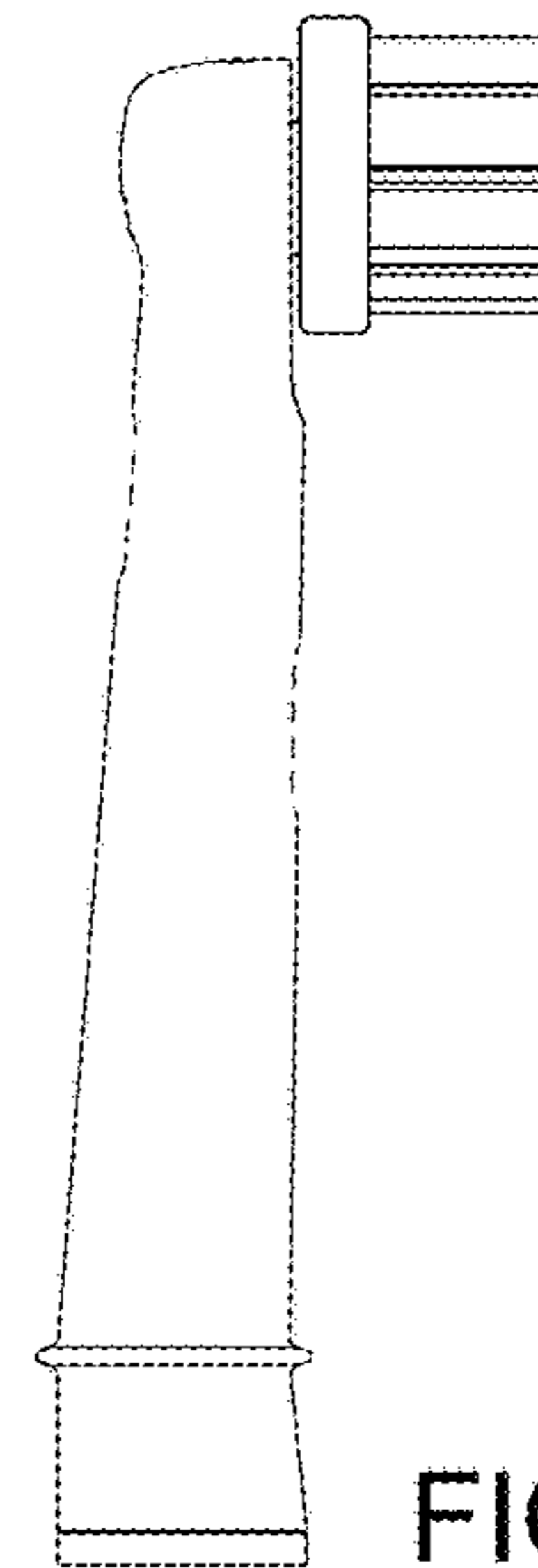

FIG. 40

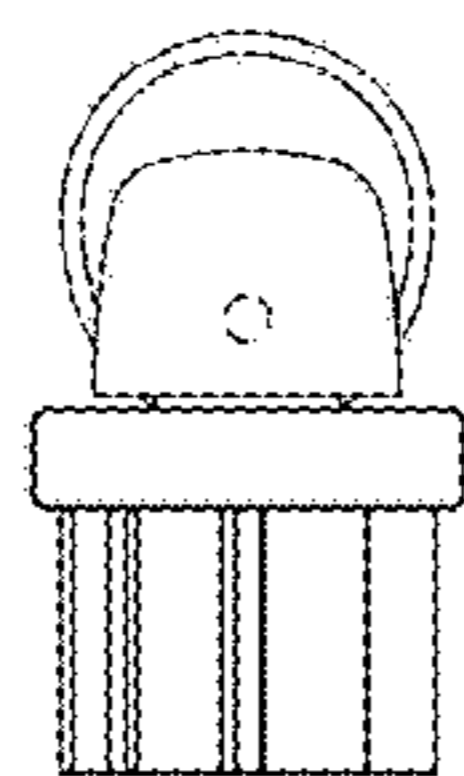

FIG. 41

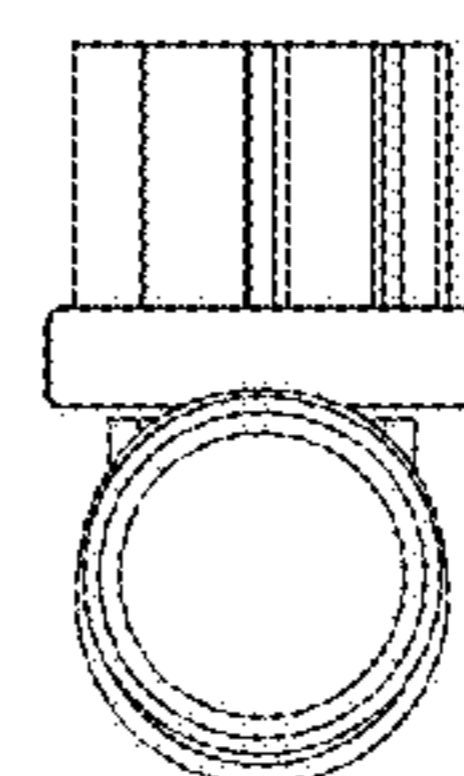

FIG. 42

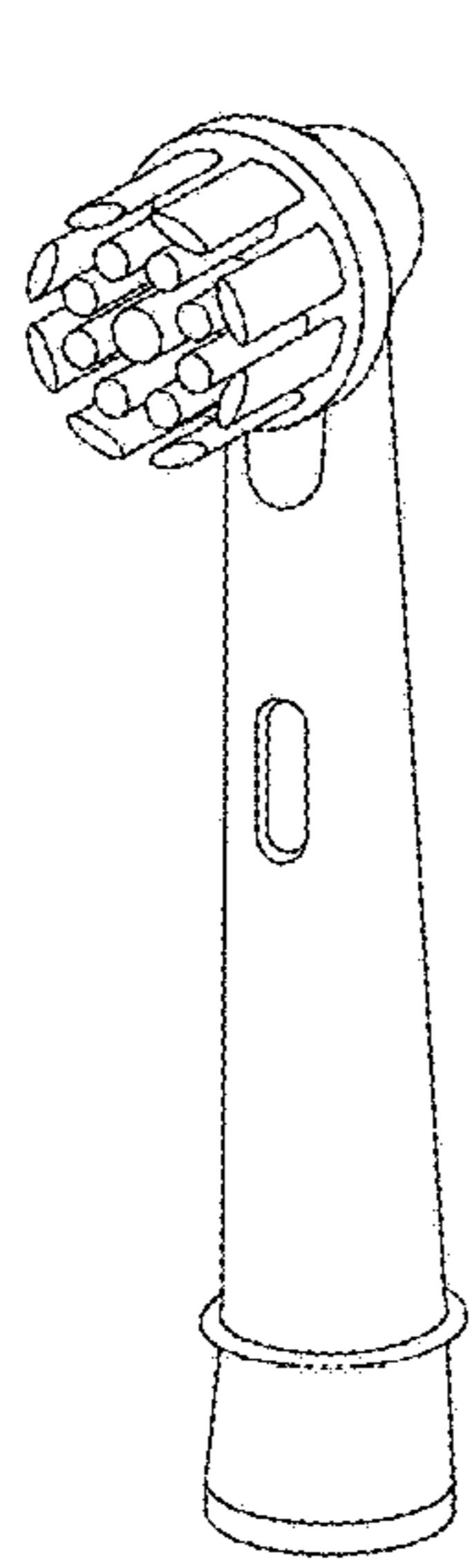

FIG. 43

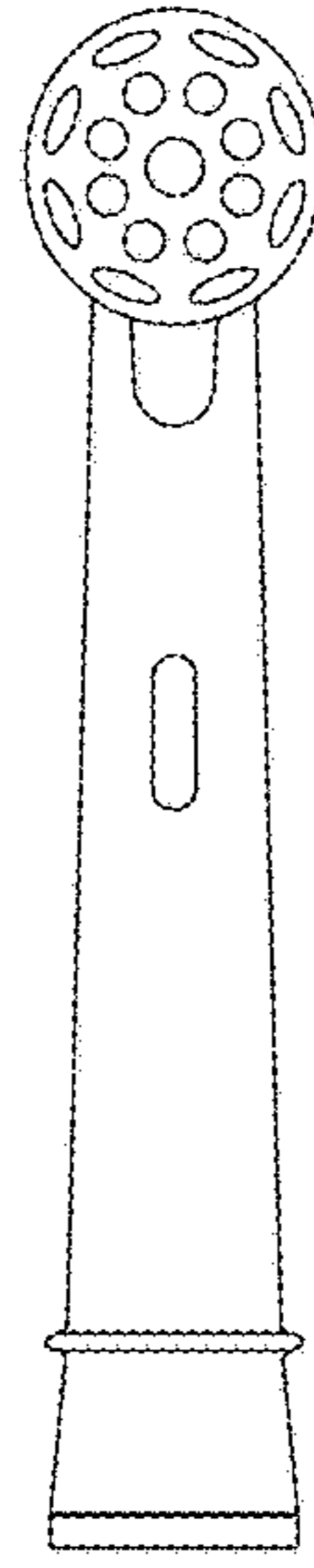

FIG. 44

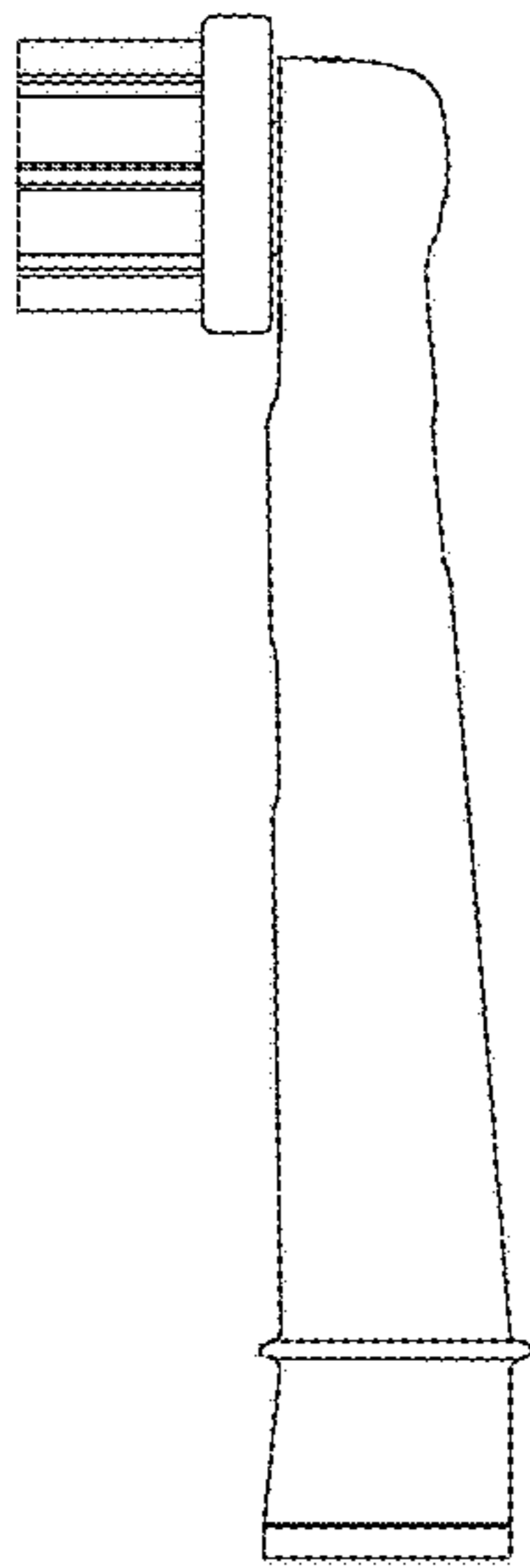

FIG. 45

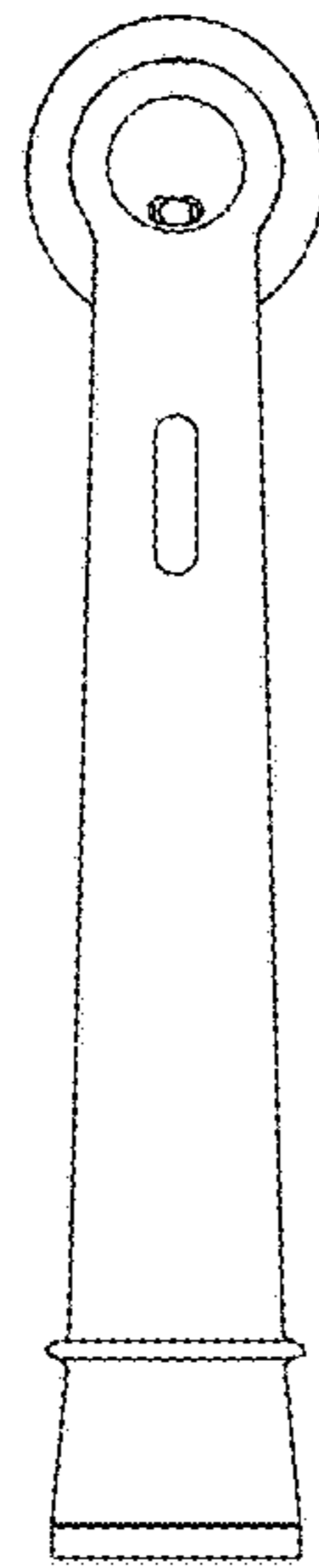

FIG. 46

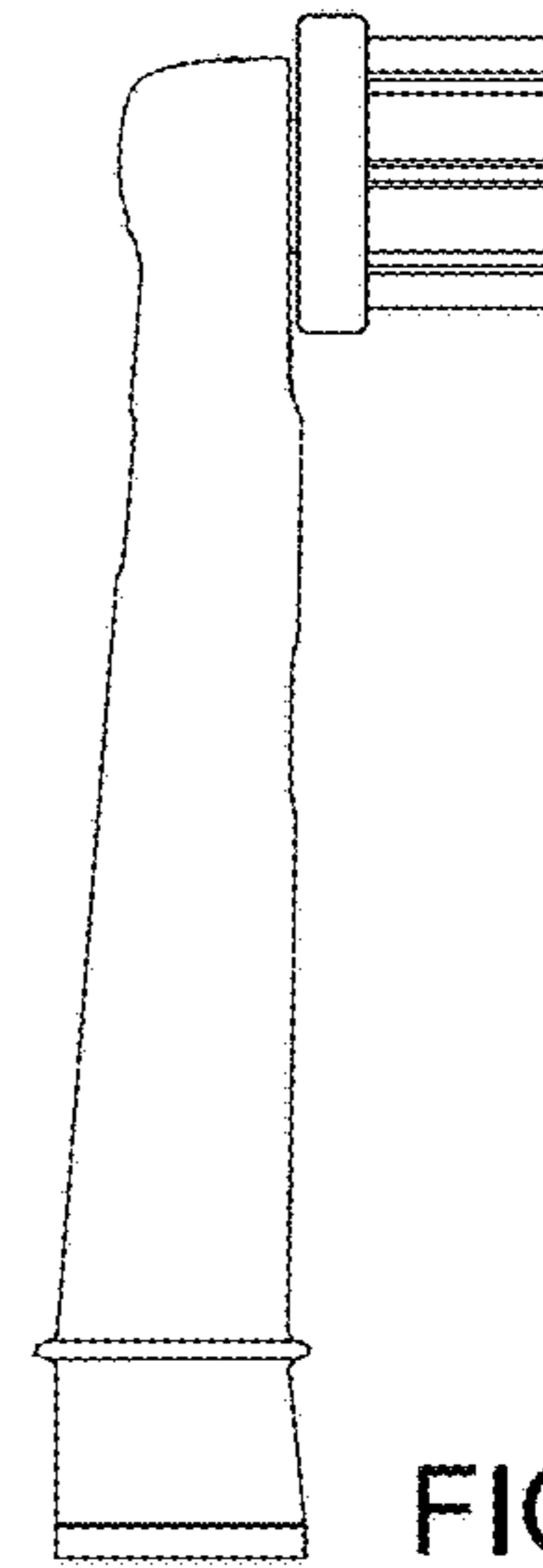

FIG. 47

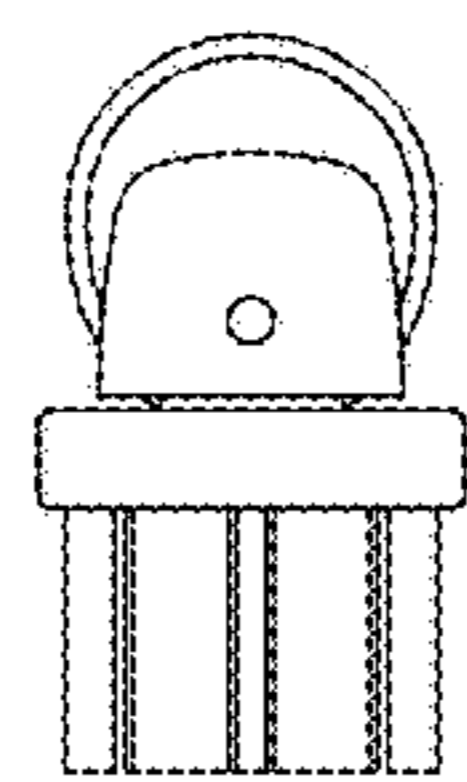

FIG. 48

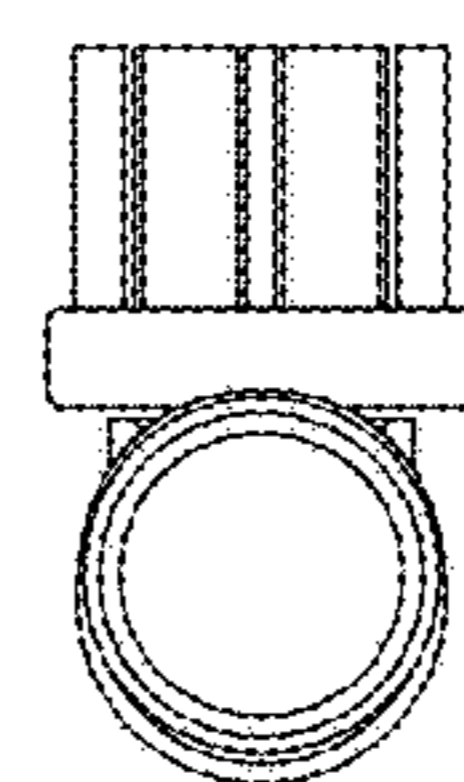

FIG. 49

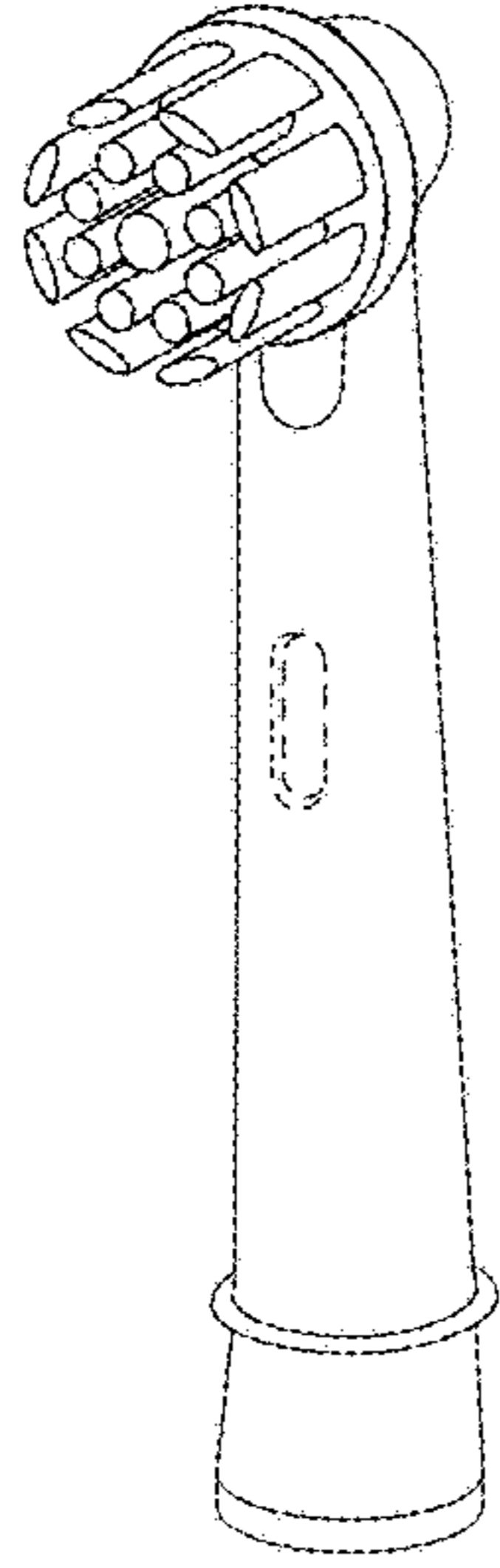

FIG. 50

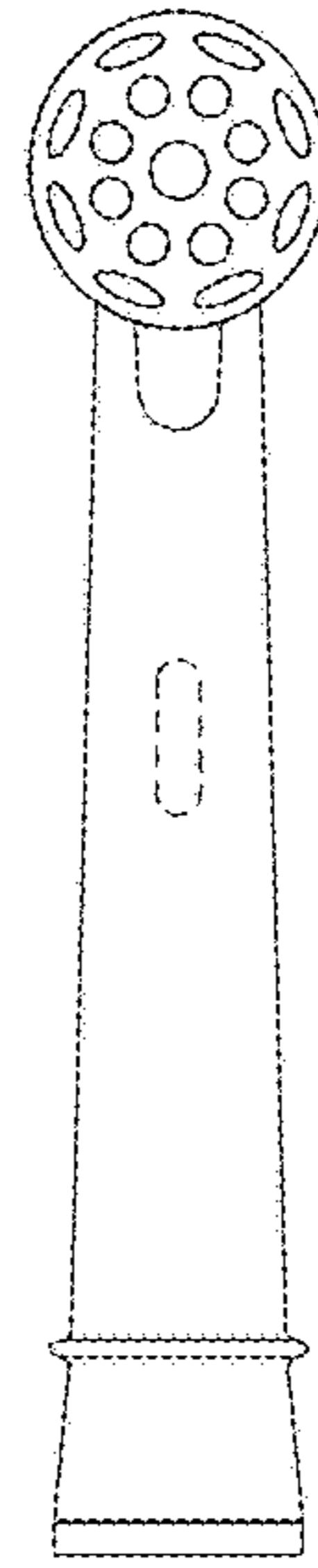

FIG. 51

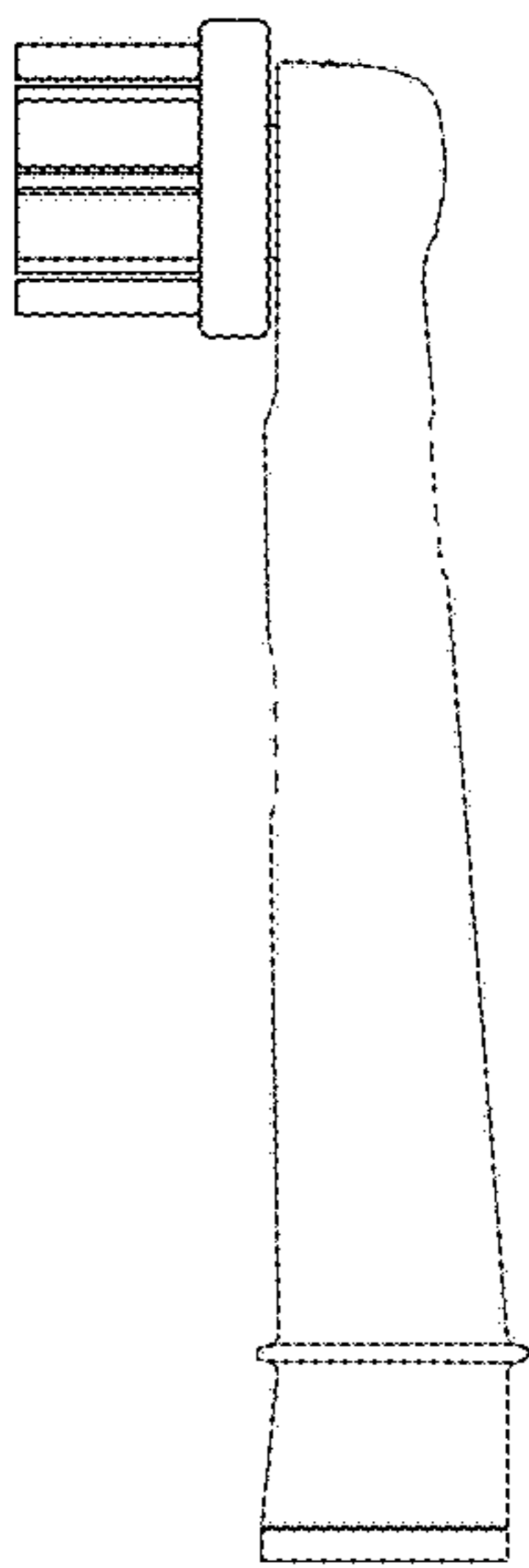

FIG. 52

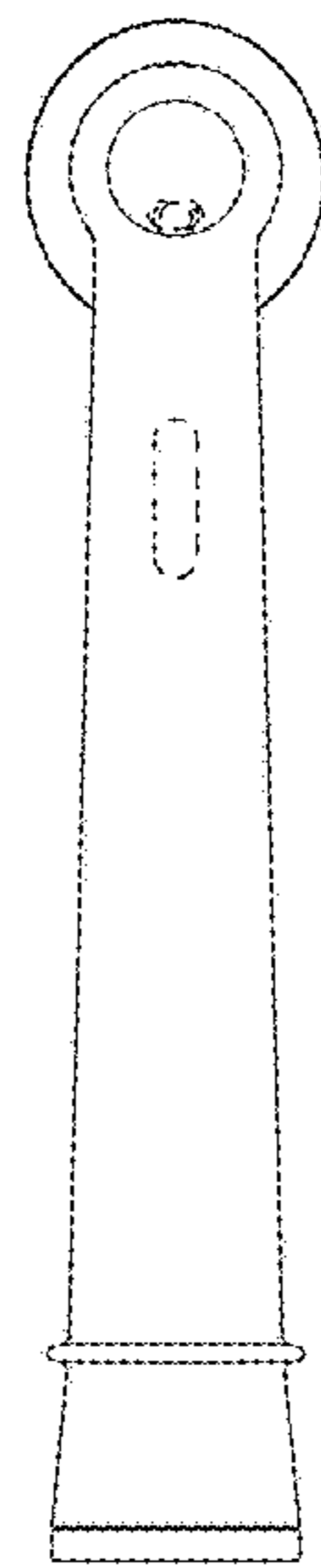

FIG. 53

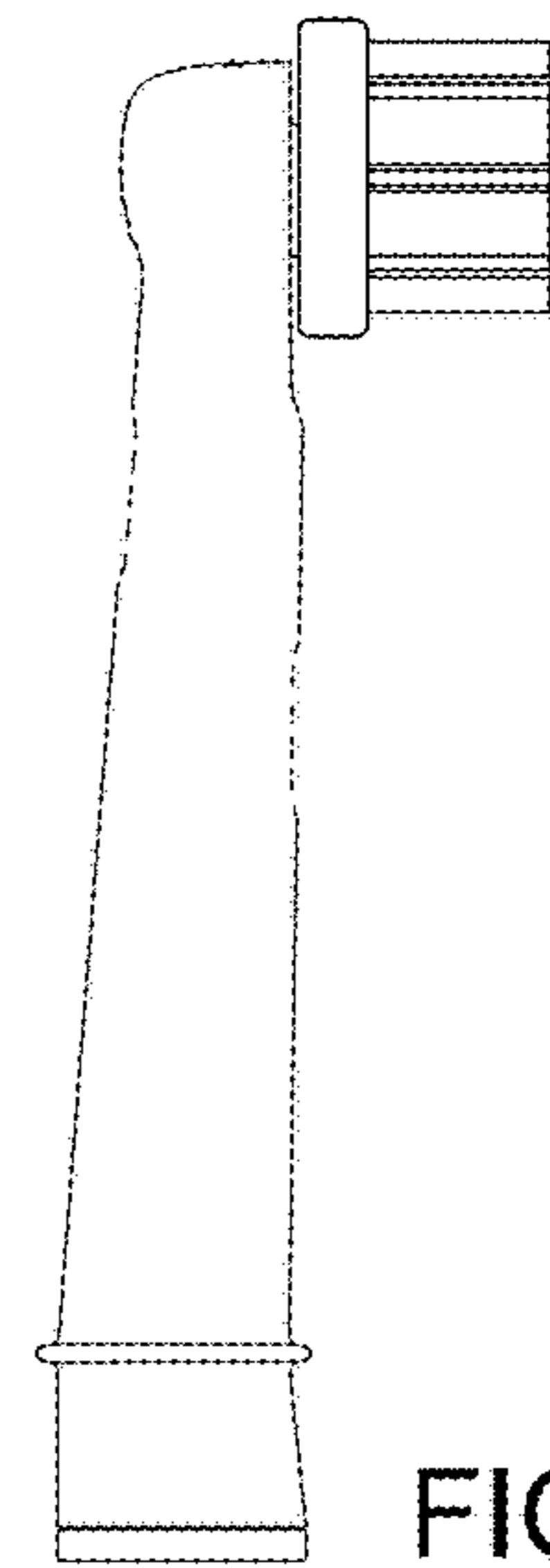

FIG. 54

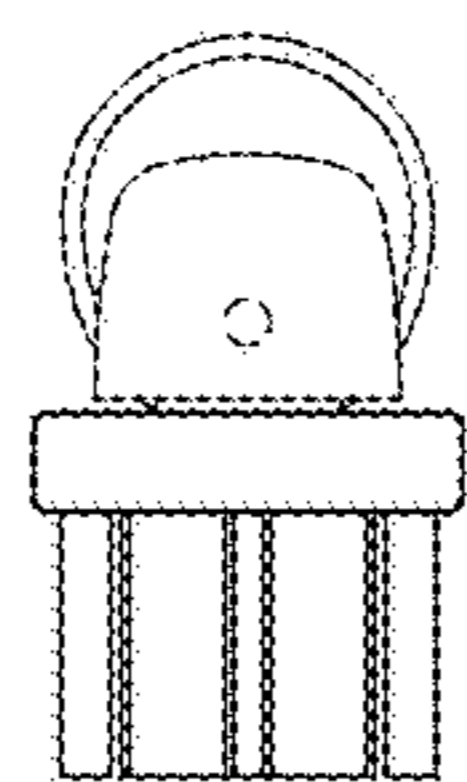

FIG. 55

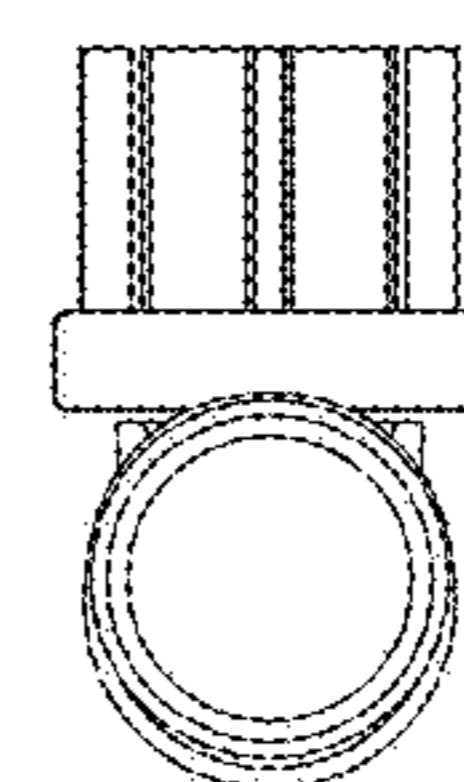

FIG. 56