

US00D854829S

(12) **United States Design Patent** (10) **Patent No.:** **US D854,829 S**
Taxel et al. (45) **Date of Patent:** **** Jul. 30, 2019**

(54) **TOTE BAG**

(71) Applicant: **Positive Promotions, Inc.**, Hauppauge, NY (US)

(72) Inventors: **Nelson Taxel**, Hauppauge, NY (US); **Thomas Morgan**, Hauppauge, NY (US); **Yvette MacIntyre**, Hauppauge, NY (US); **Frank Stinga**, Hauppauge, NY (US)

(73) Assignee: **Positive Promotions, Inc.**, Hauppauge, NY (US)

(**) Term: **15 Years**

(21) Appl. No.: **29/568,599**

(22) Filed: **Jun. 20, 2016**

(51) **LOC (11) Cl.** **03-01**

(52) **U.S. Cl.**
USPC **D3/299**

(58) **Field of Classification Search**
USPC D3/228, 224, 215, 221, 226, 247, 269, D3/299, 273, 276, 289, 293, 290, 301, D3/303, 318, 319; D9/702, 703, 705, D9/707, 709, 710, 433, 901
CPC A47C 7/62; A47C 1/14
See application file for complete search history.

(56) **References Cited**

U.S. PATENT DOCUMENTS

D136,560 S *	10/1943	Lebaigue	D3/243
D160,921 S *	11/1950	Chase et al.	206/233
D249,392 S *	9/1978	Pelavin	D3/303
D287,428 S *	12/1986	Knoepke	D3/299
D306,654 S *	3/1990	Brown	D3/218
D420,511 S *	2/2000	du Sartel	D3/232
D425,303 S *	5/2000	Klonowski	D3/201
D438,007 S *	2/2001	Holland	D3/299
D438,008 S *	2/2001	Snider	D3/299
D439,047 S *	3/2001	Holland	D3/299

D463,121 S *	9/2002	DeChant	D3/276
D465,651 S *	11/2002	Platte, III	D3/303
D471,014 S *	3/2003	Shapiro	D3/290
D520,747 S *	5/2006	McClain	D3/290
D530,917 S *	10/2006	Conforti	D3/299
D537,632 S *	3/2007	Quansah	D3/303
D548,972 S *	8/2007	Wald	D12/415
D606,754 S *	12/2009	Baron	D3/303
D750,891 S *	3/2016	Lank	D3/290

* cited by examiner

Primary Examiner — Holly E Thurman

(74) *Attorney, Agent, or Firm* — Abelman, Frayne & Schwab

(57) **CLAIM**

The ornamental design for a tote bag, as shown and described.

DESCRIPTION

FIG. 1 is a front, top and left side perspective view of the tote bag showing the new design; FIG. 2 is a top plan thereof; FIG. 3 is a front elevation thereof; FIG. 4 is a right side elevation thereof, the left side elevation being a mirror image thereof; FIG. 5 is rear elevation thereof; FIG. 6 is a bottom plan thereof; FIG. 7 is a front, top and left side perspective view of a second embodiment of the new design; FIG. 8 is a top plan thereof; FIG. 9 is a front elevation thereof; FIG. 10 is a right side elevation thereof, the left side elevation being a mirror image thereof; FIG. 11 is rear elevation thereof; and, FIG. 12 is a bottom plan thereof. The dotted lines depict stitching, and form part of the claimed design. The broken lines depict portions of the tote bag that form no part of the claimed design.

1 Claim, 6 Drawing Sheets

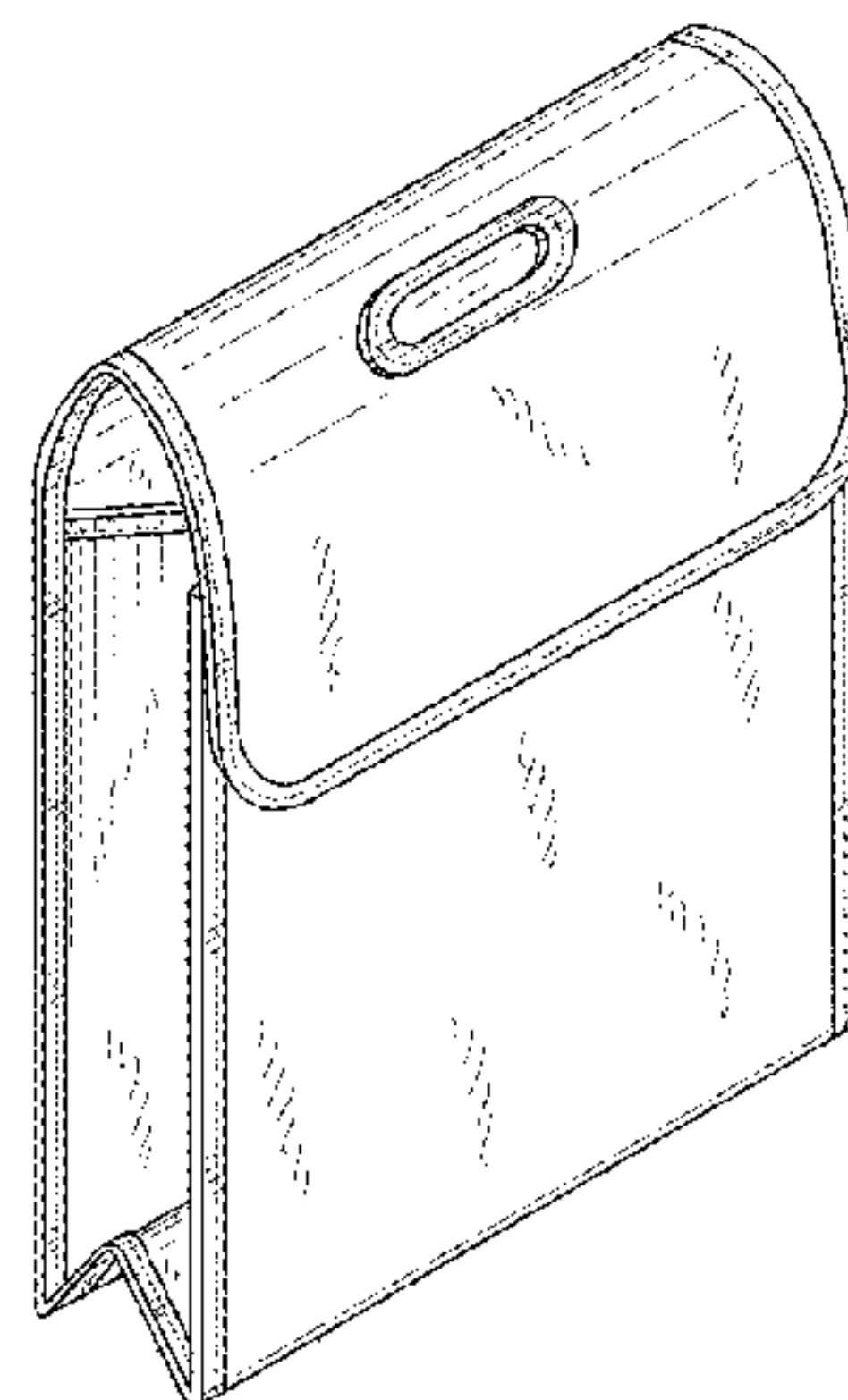
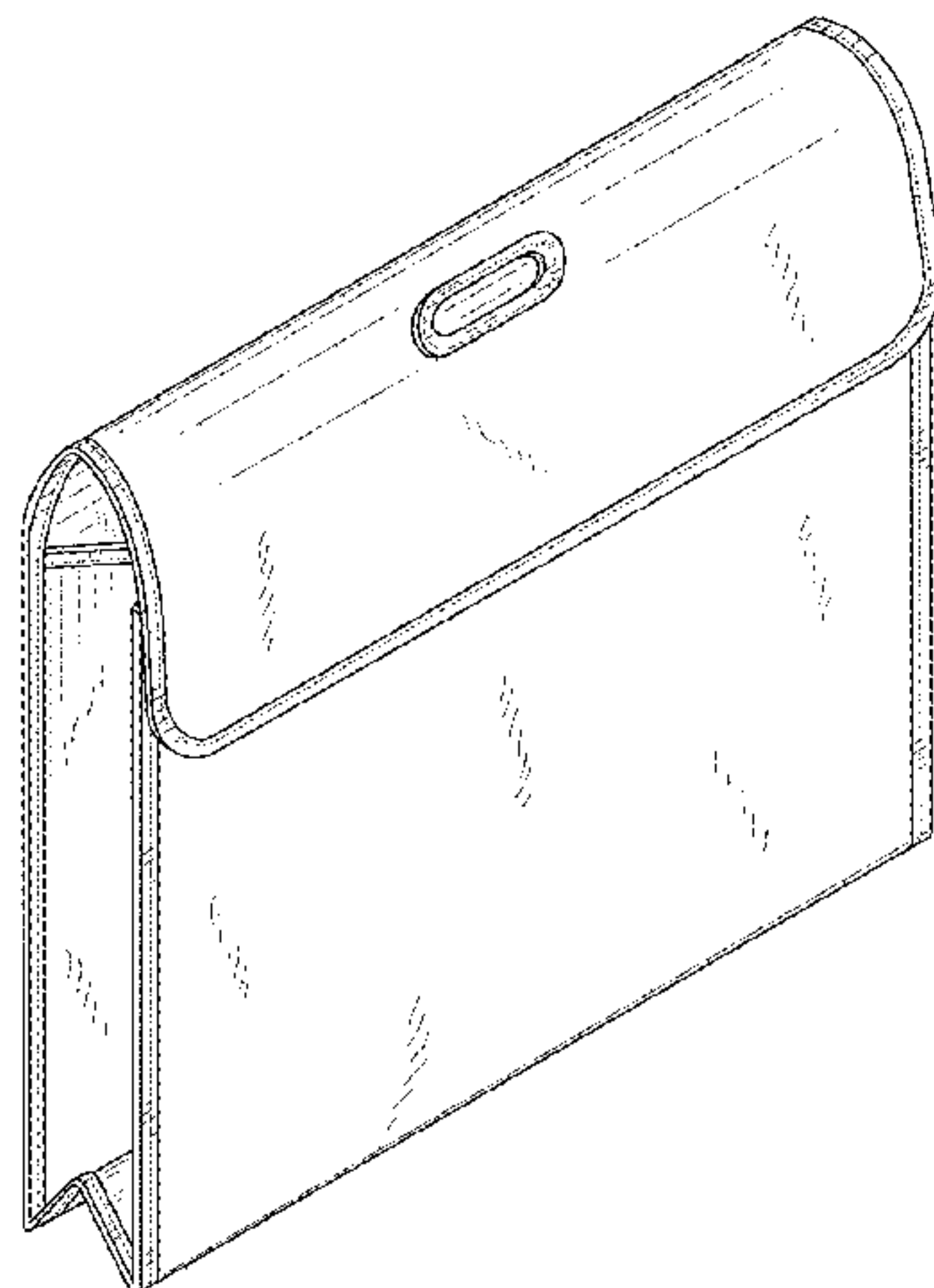

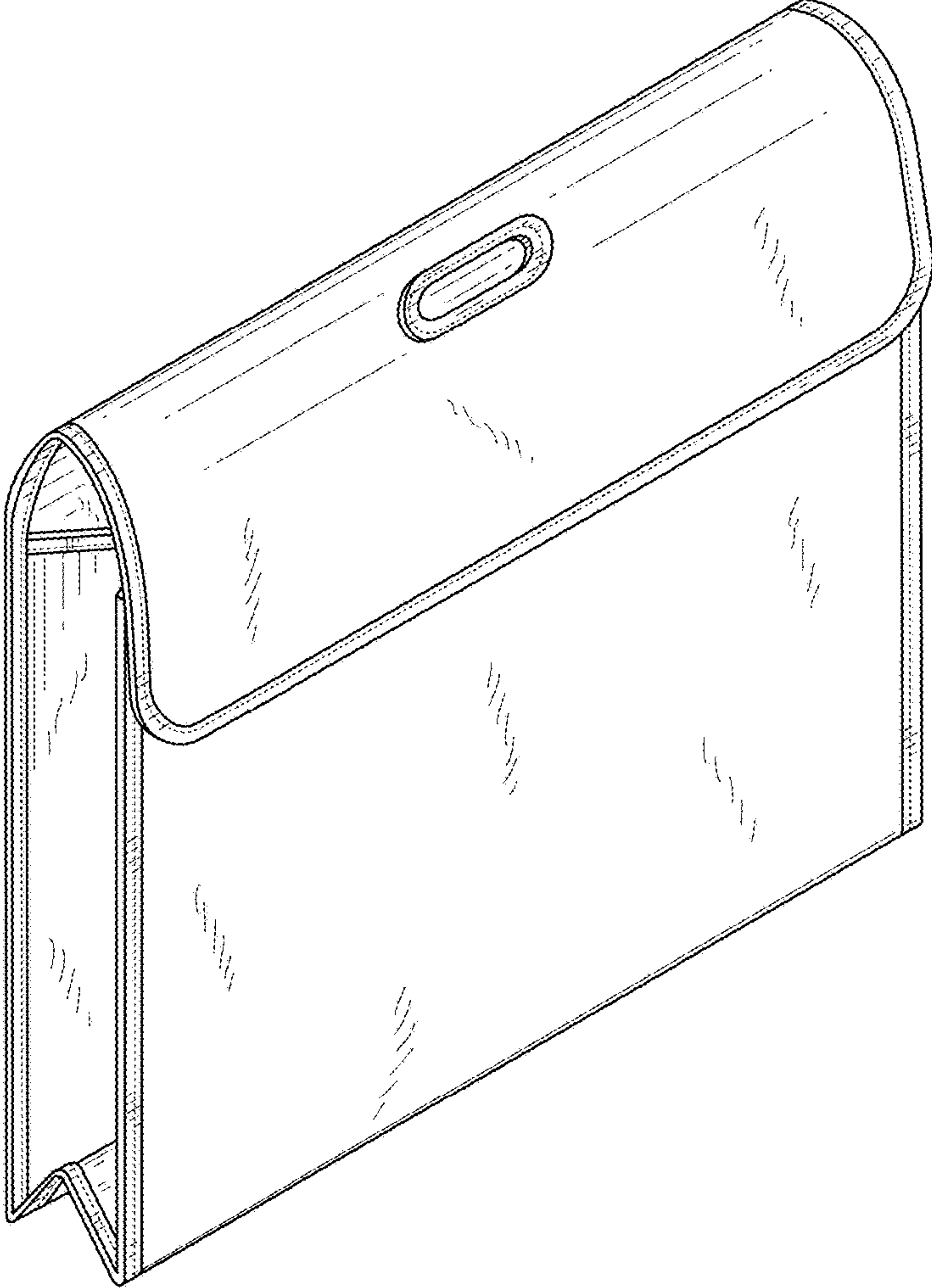

FIG. 1

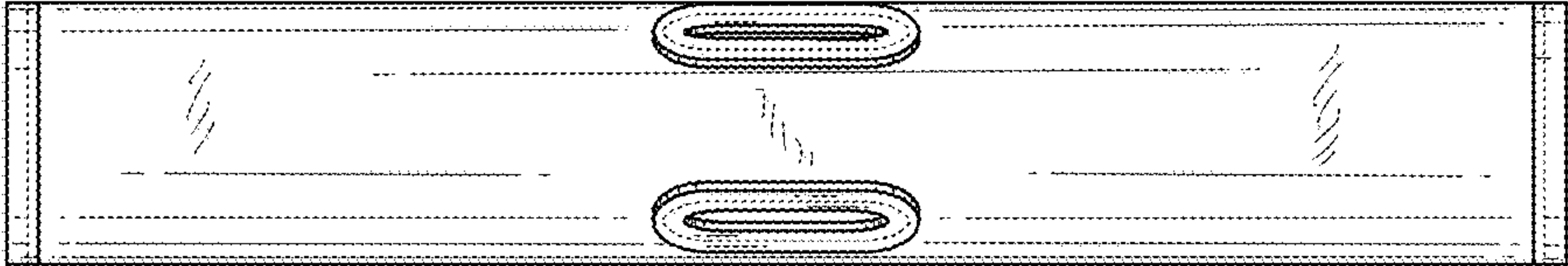

FIG. 2

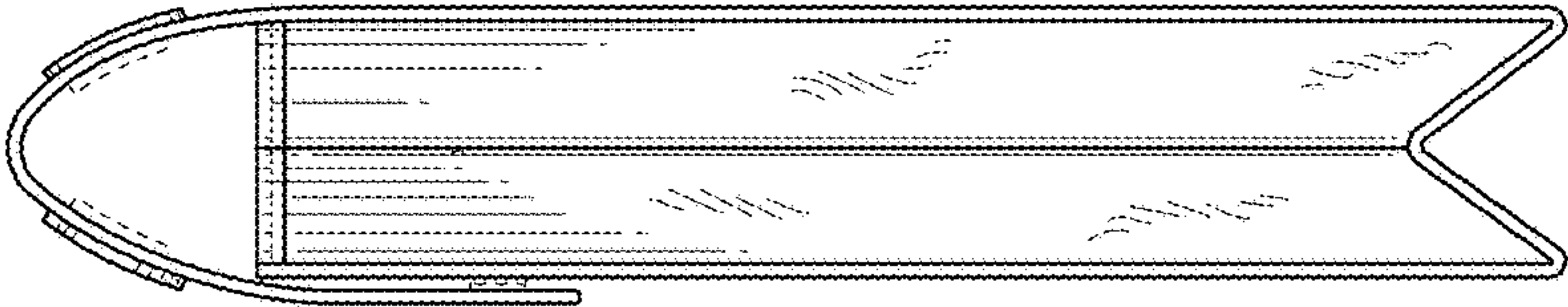

FIG. 4

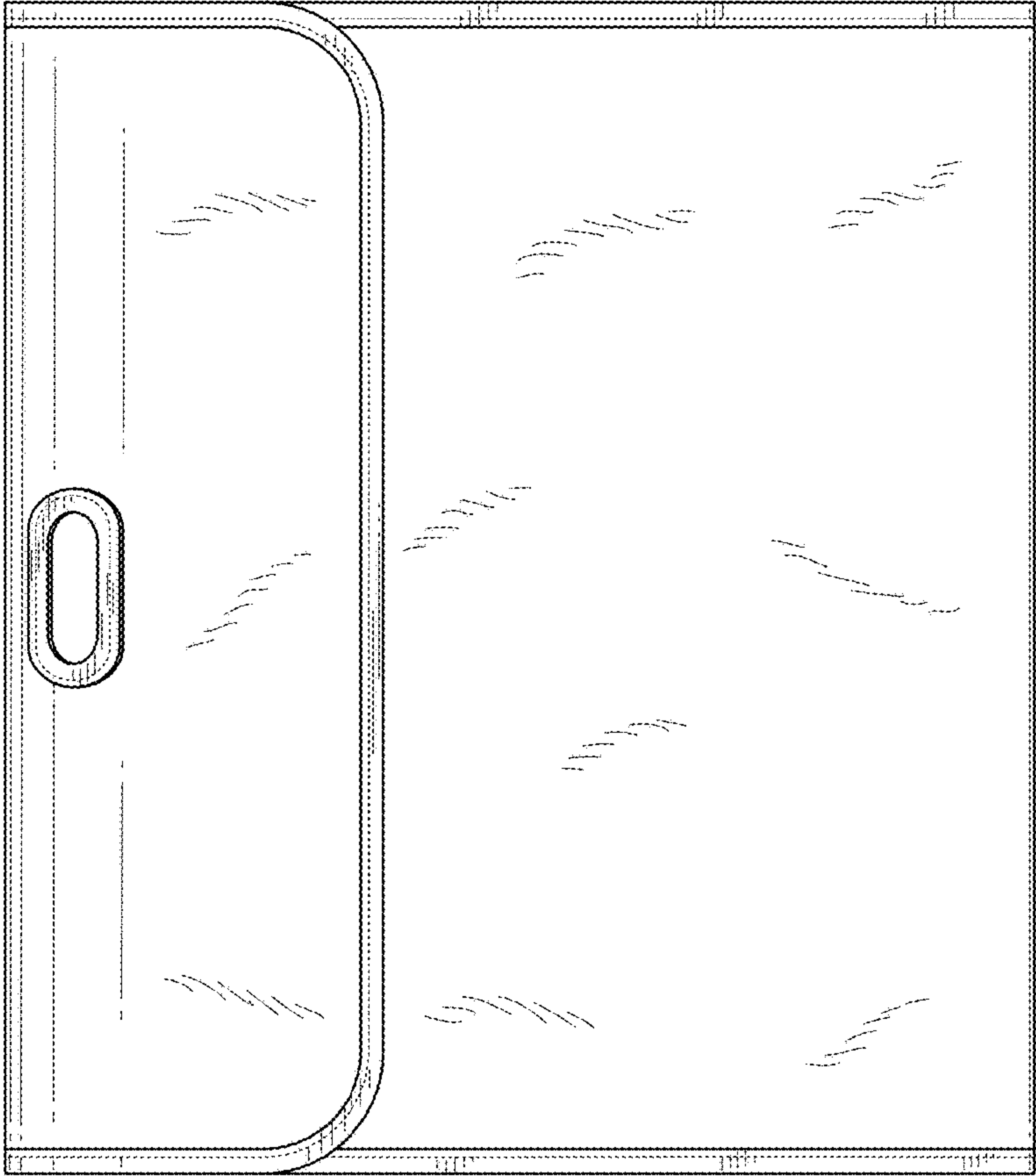

FIG. 3

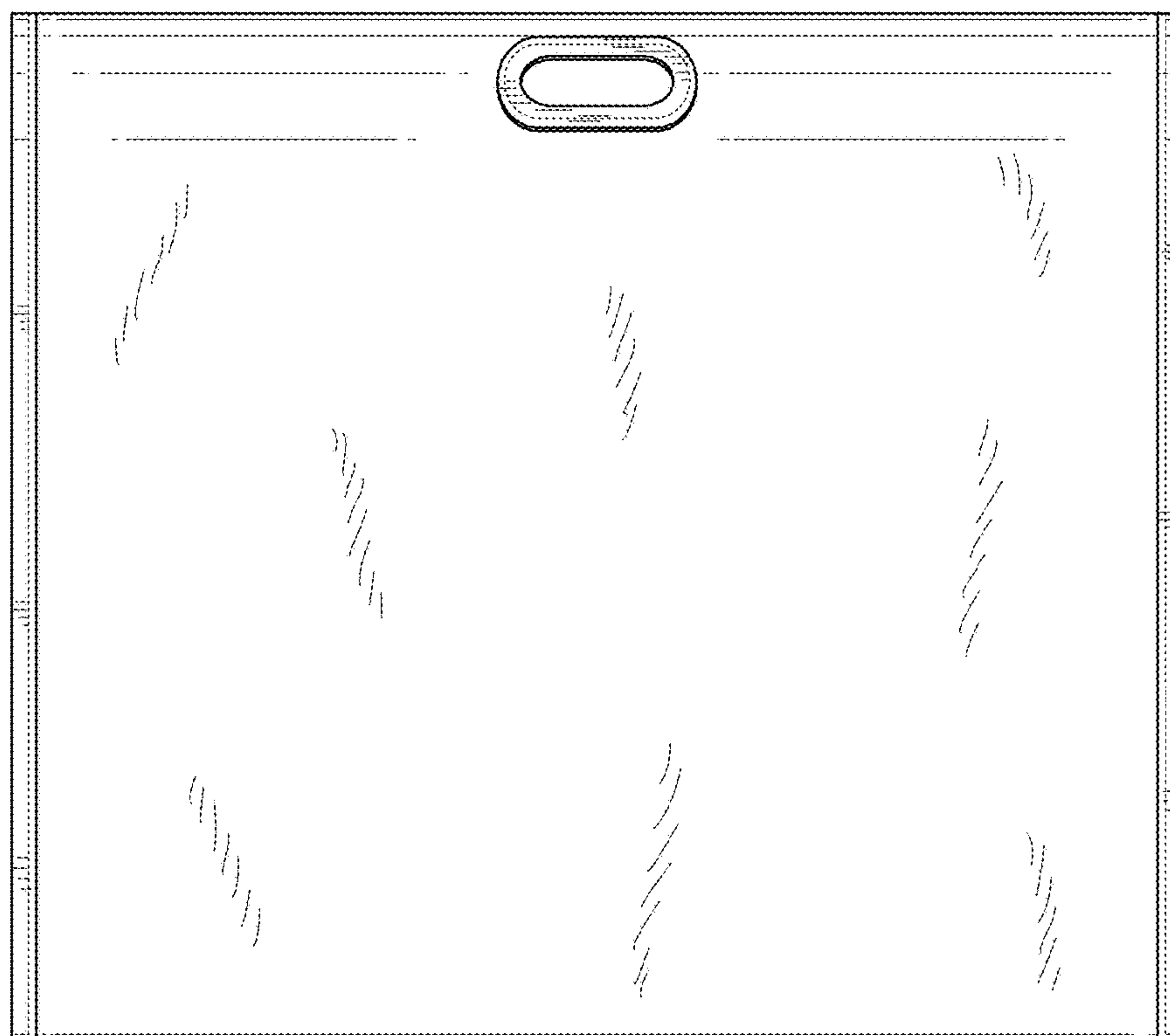

FIG. 5

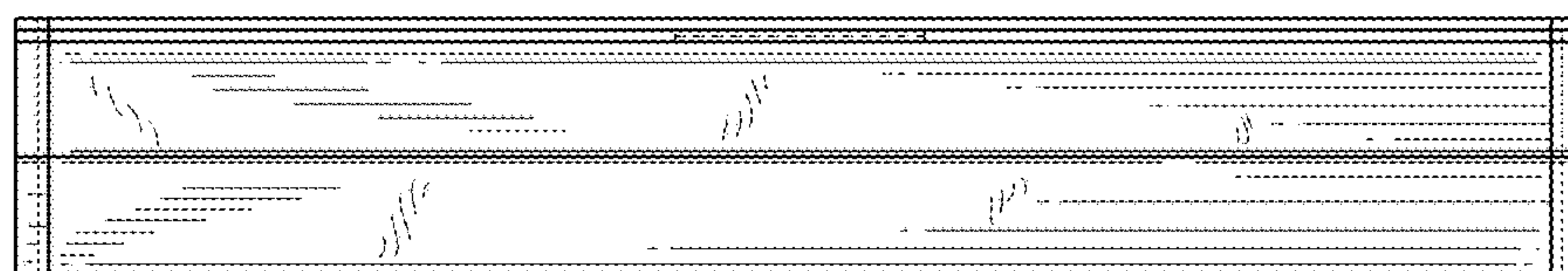

FIG. 6

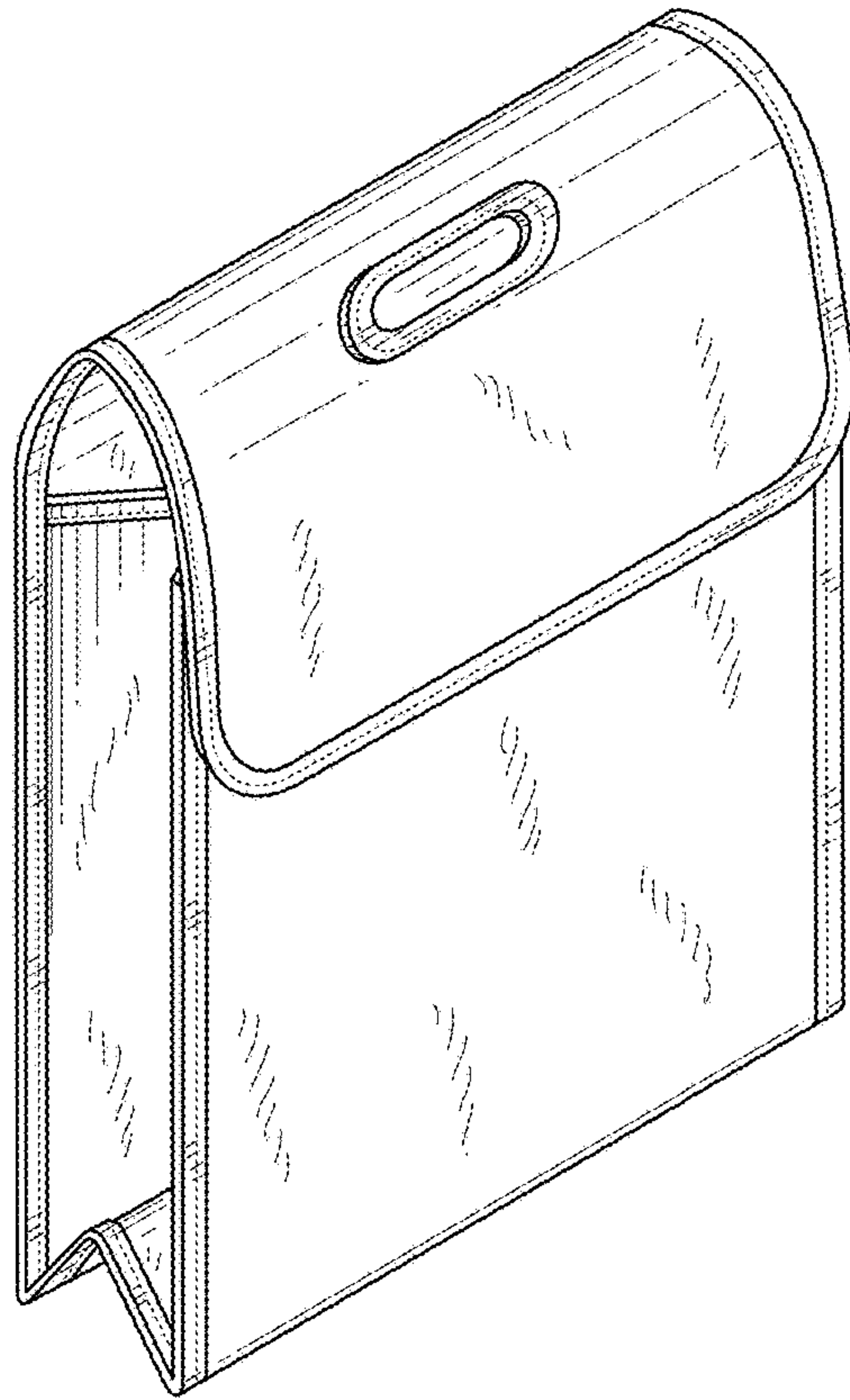

FIG. 7

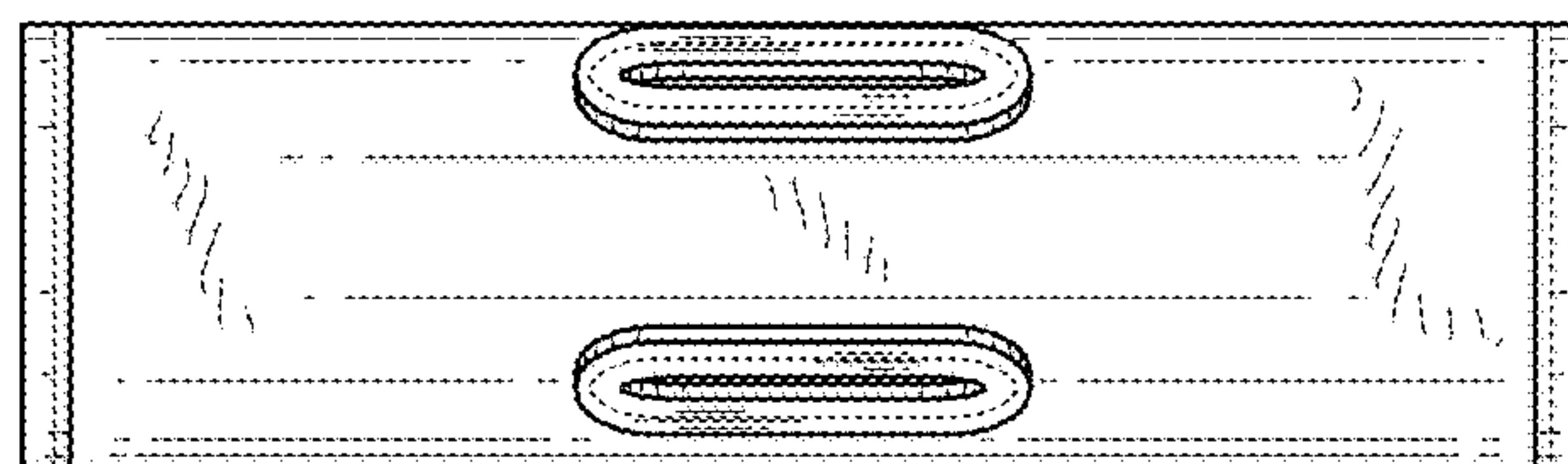

FIG. 8

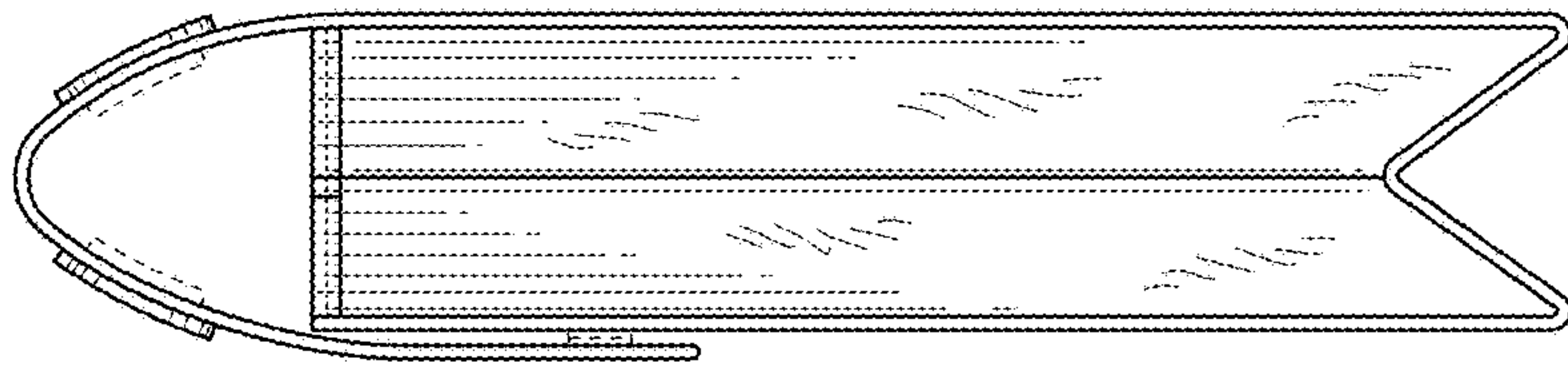

FIG. 10

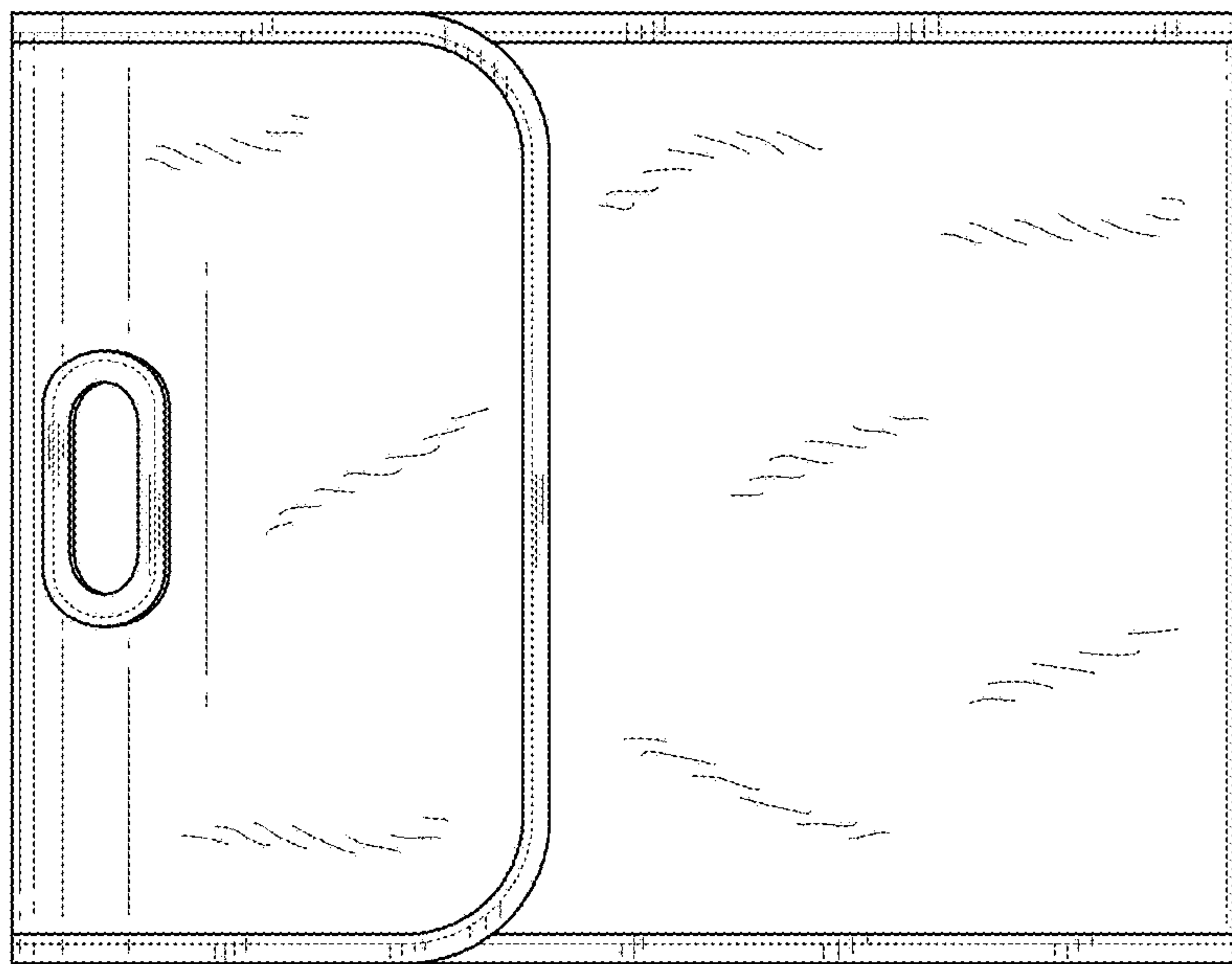

FIG. 9

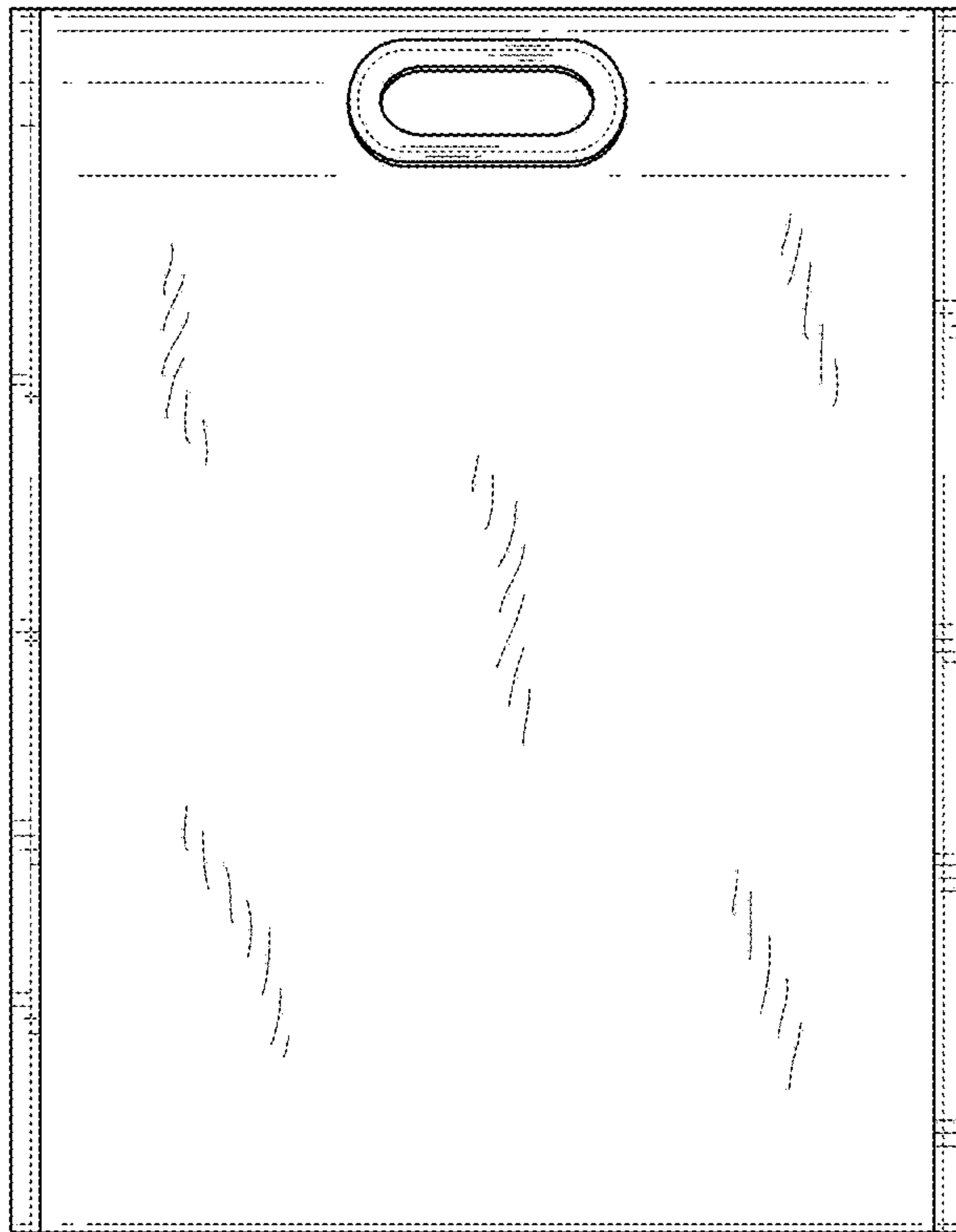

FIG. 11

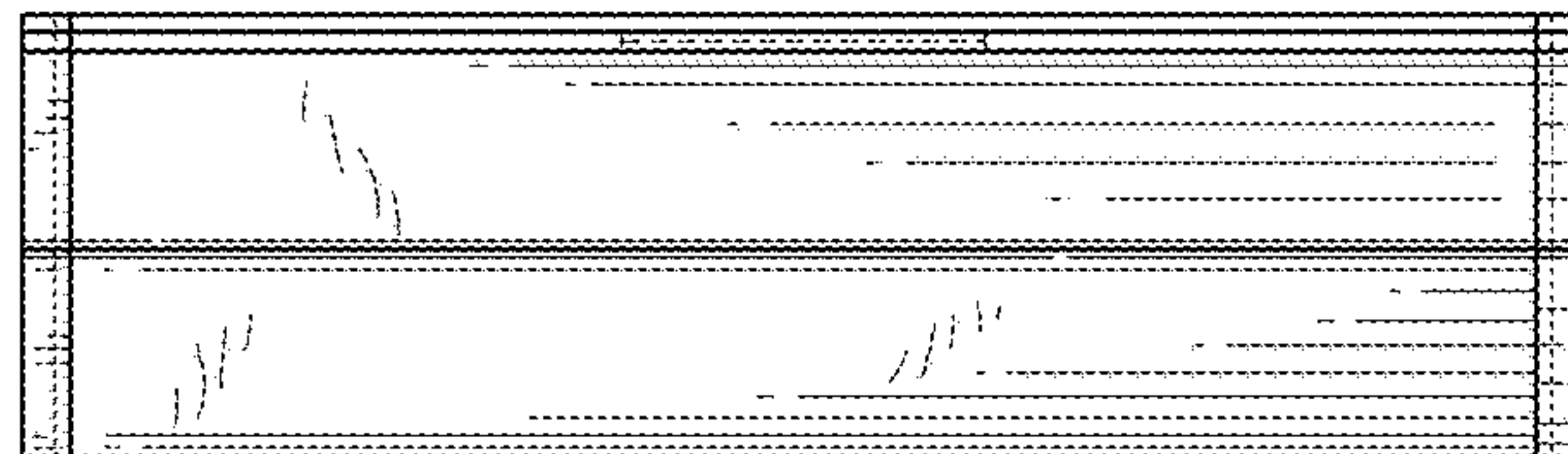

FIG. 12