



US00D854817S

(12) **United States Design Patent** (10) **Patent No.:** **US D854,817 S**  
**Rabe et al.** (45) **Date of Patent:** **\*\* Jul. 30, 2019**

(54) **BACKPACK**

(71) Applicant: **Dell Products L.P.**, Round Rock, TX (US)

(72) Inventors: **Chad A. Rabe**, Round Rock, TX (US);  
**Bruce A. Benzon**, Round Rock, TX (US)

(73) Assignee: **Dell Products L.P.**, Round Rock, TX (US)

(\*\*) Term: **15 Years**

(21) Appl. No.: **29/642,092**

(22) Filed: **Mar. 27, 2018**

(51) **LOC (11) Cl.** ..... **03-01**

(52) **U.S. Cl.**  
USPC ..... **D3/217**

(58) **Field of Classification Search**  
USPC ..... D3/215–217, 273, 289, 290, 318, 321, D3/322, 323  
CPC .. A45F 3/04; A45F 3/042; A45F 3/047; A45F 3/08; A45F 3/10; A45F 3/14; A45F 4/02; A45F 4/08; A45F 2200/05; A45F 2200/0525; A45C 13/08; A45C 13/083  
See application file for complete search history.

(56) **References Cited**

**U.S. PATENT DOCUMENTS**

D479,186 S \* 9/2003 Hassett ..... D12/416  
D709,689 S \* 7/2014 Brunazzi ..... D3/217  
D726,405 S \* 4/2015 Nassanian ..... D3/216

(Continued)

**OTHER PUBLICATIONS**

Incase, “Backpacks,” downloaded from <https://www.incase.com/products/bags/backpacks>, Jun. 15, 2018, 14 pages.

(Continued)

*Primary Examiner* — Anhdao Doan

*Assistant Examiner* — Mary Shannon Malley

(74) *Attorney, Agent, or Firm* — Zagorin Cave LLP;  
Robert W. Holland

(57) **CLAIM**

The ornamental design for a backpack, as shown and described.

**DESCRIPTION**

FIG. 1 is a front perspective view of the backpack, shown with a detachable carrying case removed, comprising the present invention;

FIG. 2 is a front view thereof;

FIG. 3 is a rear view thereof;

FIG. 4 is a right side view thereof;

FIG. 5 is a left view thereof;

FIG. 6 is a top view thereof;

FIG. 7 is a bottom view thereof;

FIG. 8 is a front open interior view thereof;

FIG. 9 is a front perspective alternative view thereof with a detachable carrying case;

FIG. 10 is a front view thereof with the detachable carrying case;

FIG. 11 is a right side view thereof with the detachable carrying case;

FIG. 12 is left side view thereof with the detachable carrying case;

FIG. 13 is a top view thereof with the detachable carrying case;

FIG. 14 is a bottom view thereof with the detachable carrying case;

FIG. 15 is a front perspective exploded view with the detachable carrying case; and,

FIG. 16 is a rear view of the detachable carrying case.

The broken lines showing stitching do not form part of the claimed design. All other broken lines shown in the drawings illustrate portions of the backpack that form no part of the claimed design.

**1 Claim, 16 Drawing Sheets**

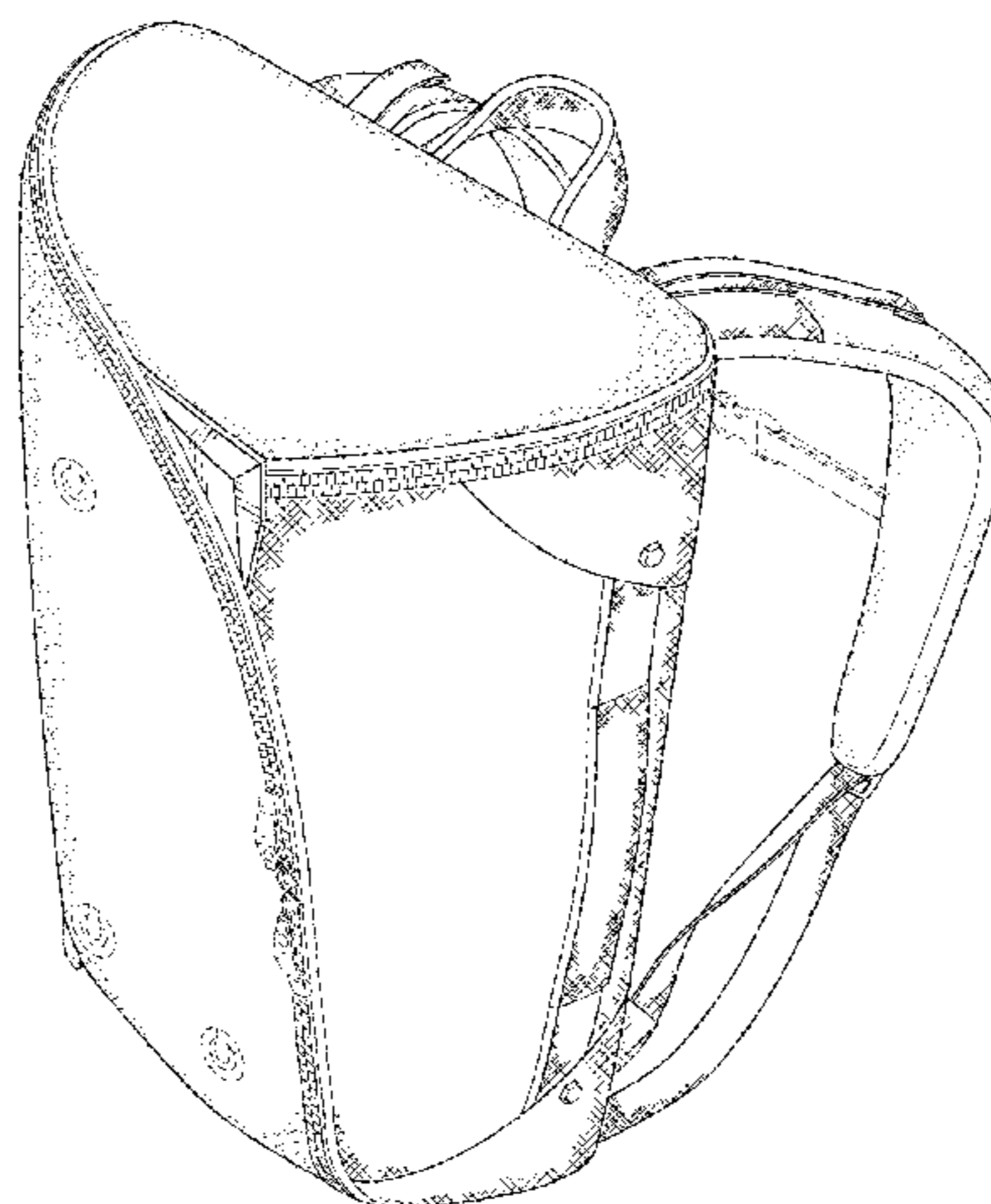

(56)

**References Cited**

U.S. PATENT DOCUMENTS

9,854,897 B1 \* 1/2018 Pelkey, Jr. .... A45F 3/04  
D811,728 S \* 3/2018 Sheikh ..... D3/217  
D815,435 S \* 4/2018 Kukathas ..... D3/285  
D821,742 S \* 7/2018 Jusic ..... D3/217  
D831,355 S \* 10/2018 Epain ..... D3/318  
D834,316 S \* 11/2018 Tobyansen ..... D3/318  
2013/0292441 A1 \* 11/2013 Shen ..... A45F 4/02  
224/579  
2017/0119131 A1 \* 5/2017 Barber ..... A45F 3/04

OTHER PUBLICATIONS

U.S. Appl. No. 29/580,521, filed Oct. 11, 2016, entitled "Back-pack," to inventor Bruce A. Benzon et al.

U.S. Appl. No. 29/612,137, filed Jul. 28, 2017, entitled "Carry Case," to inventor Bruce A. Benzon and Chad A. Rabe.

Thule, "Laptop, tablet and phone cases," downloaded from [https://www.thule.com/en-us/us/computer-phone-cases/laptop-bags/thule-subterra-laptop-bag-156-\\_3203427](https://www.thule.com/en-us/us/computer-phone-cases/laptop-bags/thule-subterra-laptop-bag-156-_3203427), Jun. 15, 2018, 3 pages.

\* cited by examiner

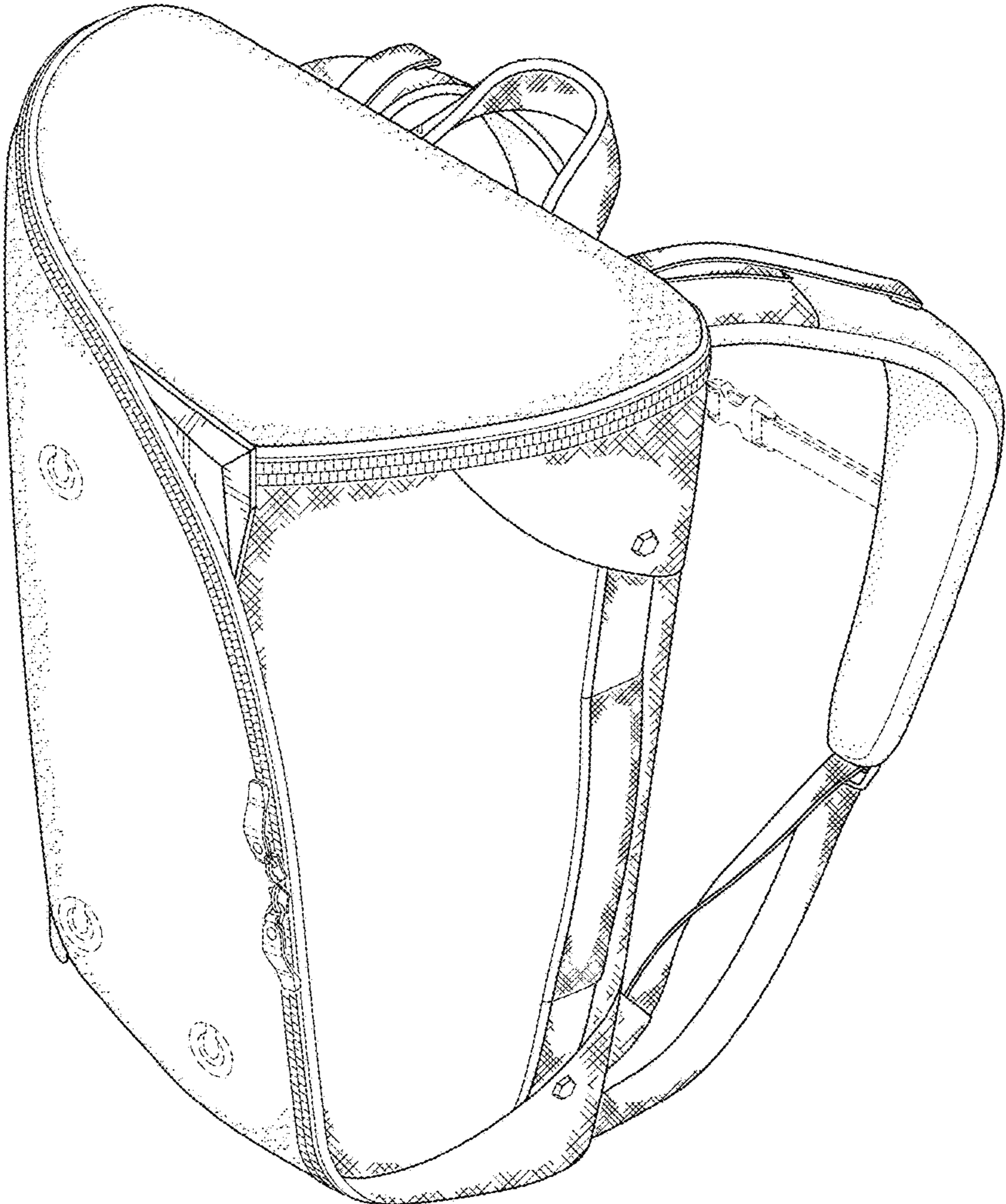

FIG. 1



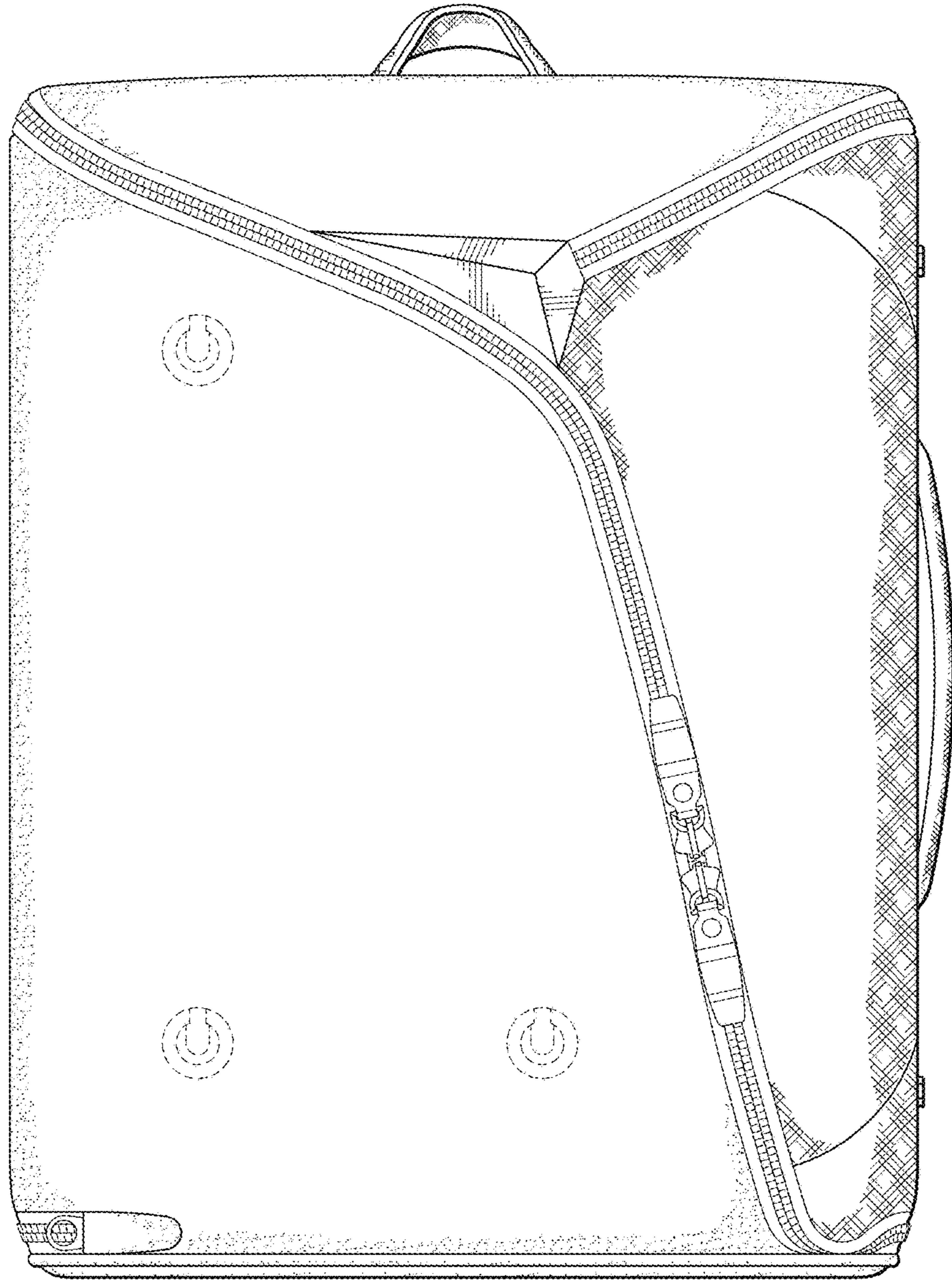

FIG. 2

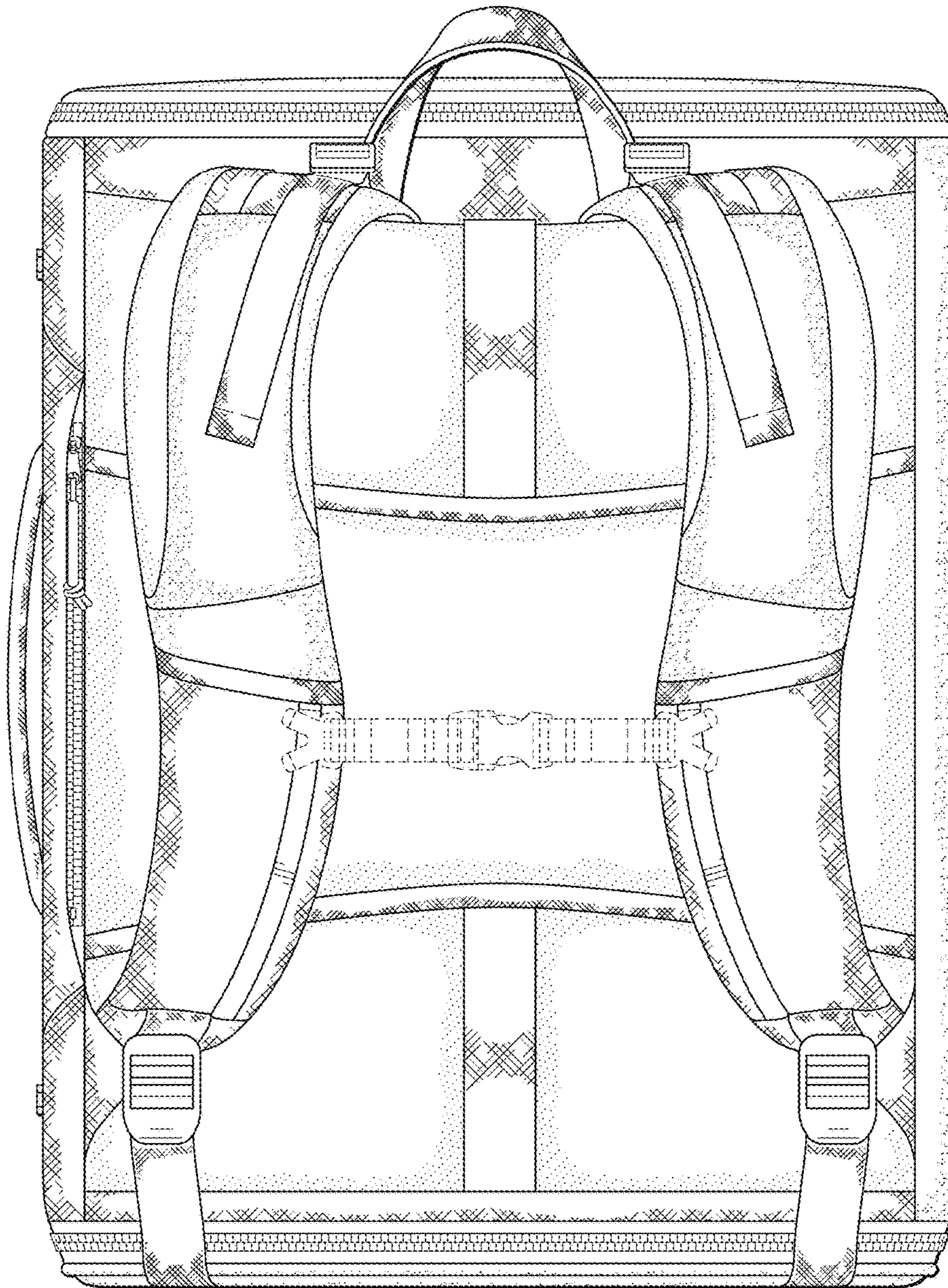

FIG. 3



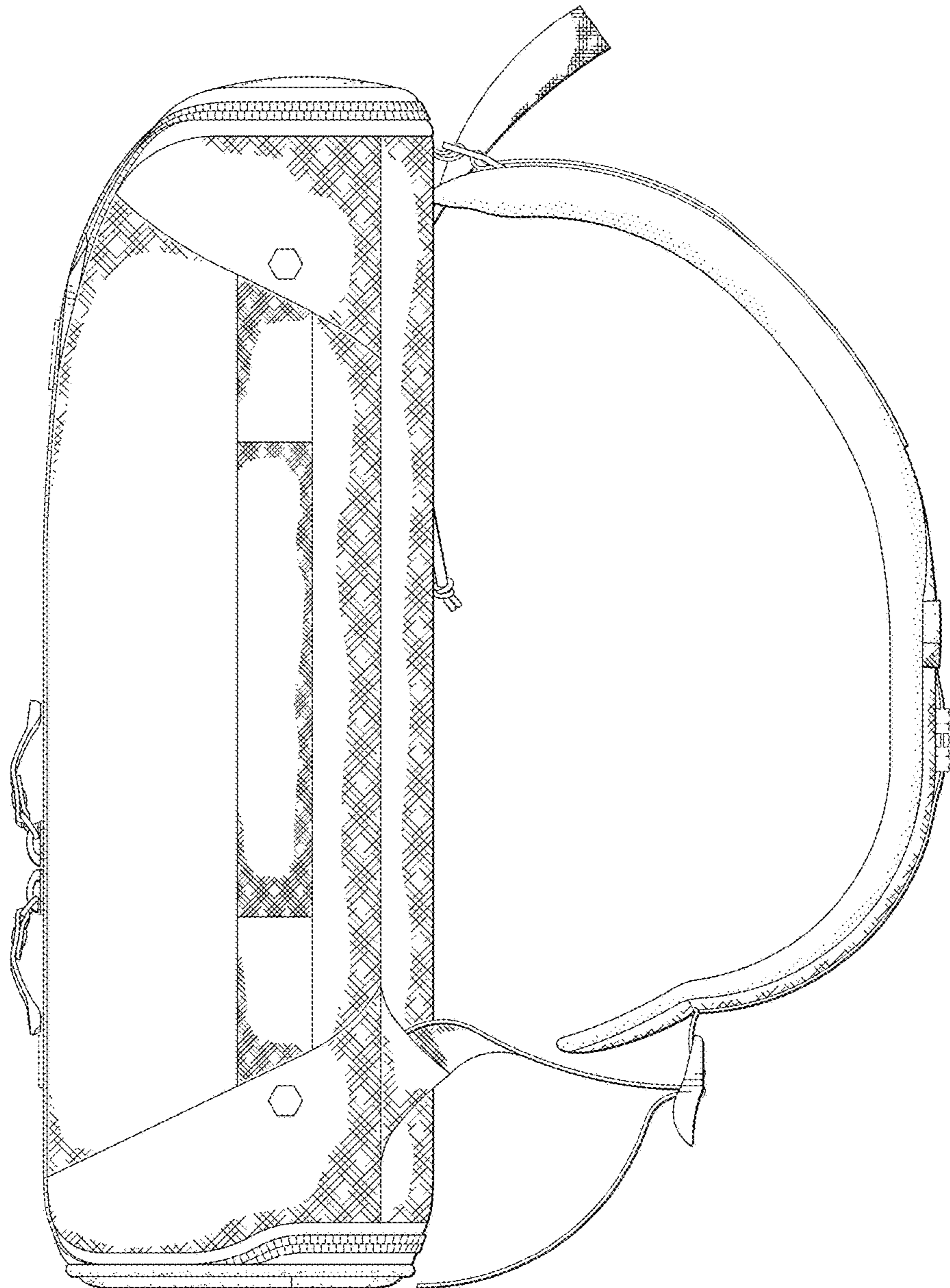

FIG. 4

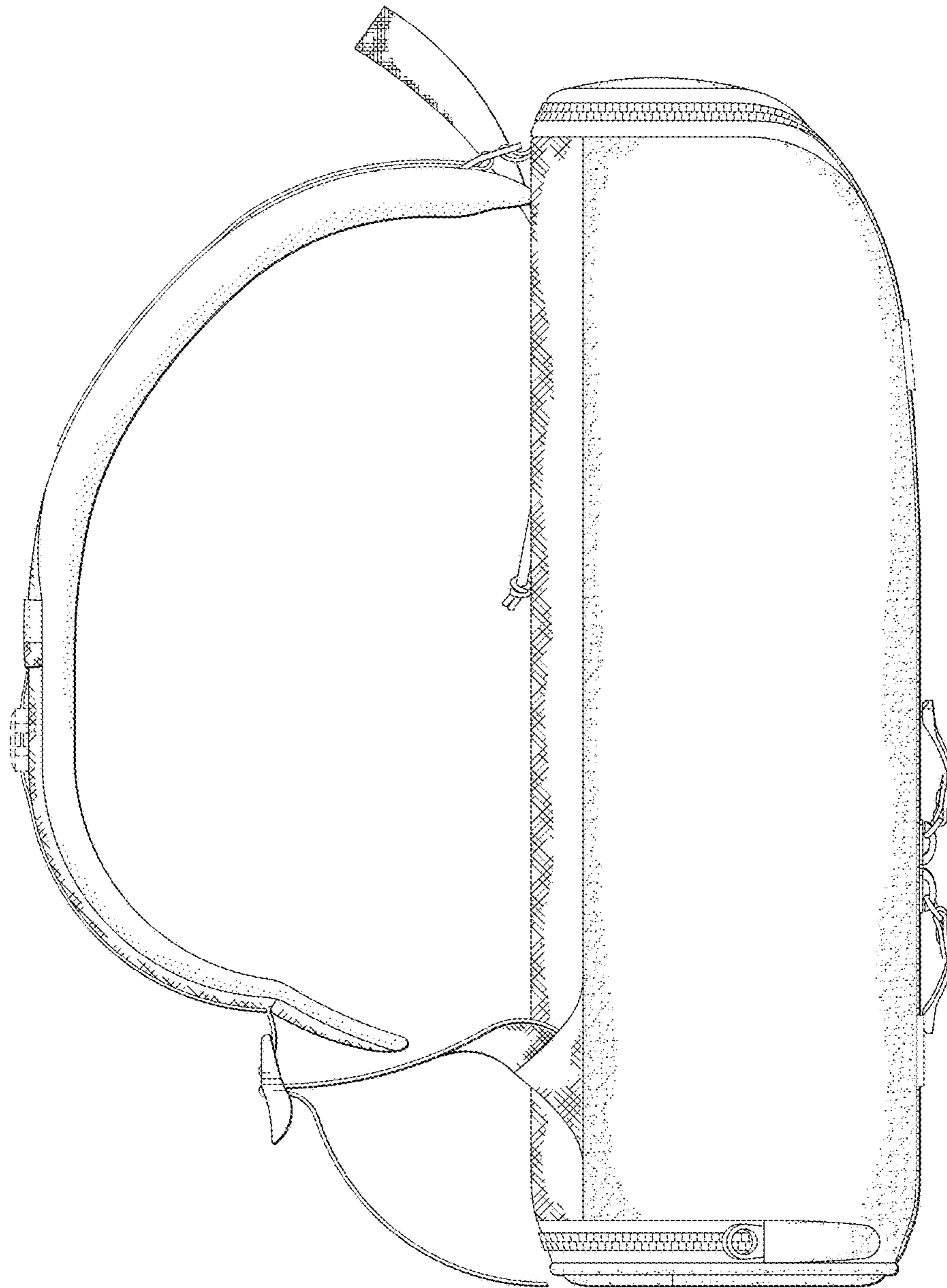

FIG. 5

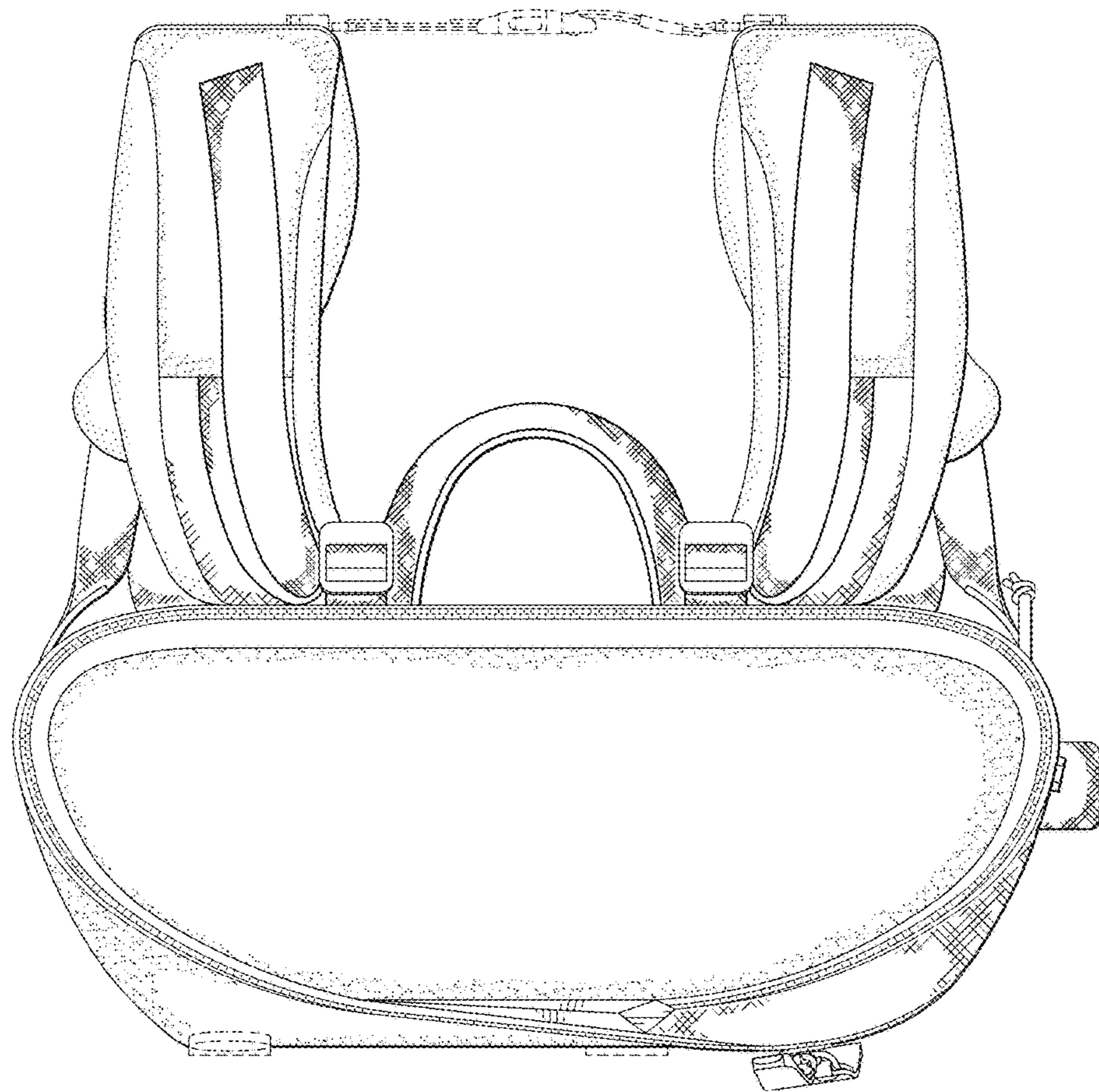

FIG. 6



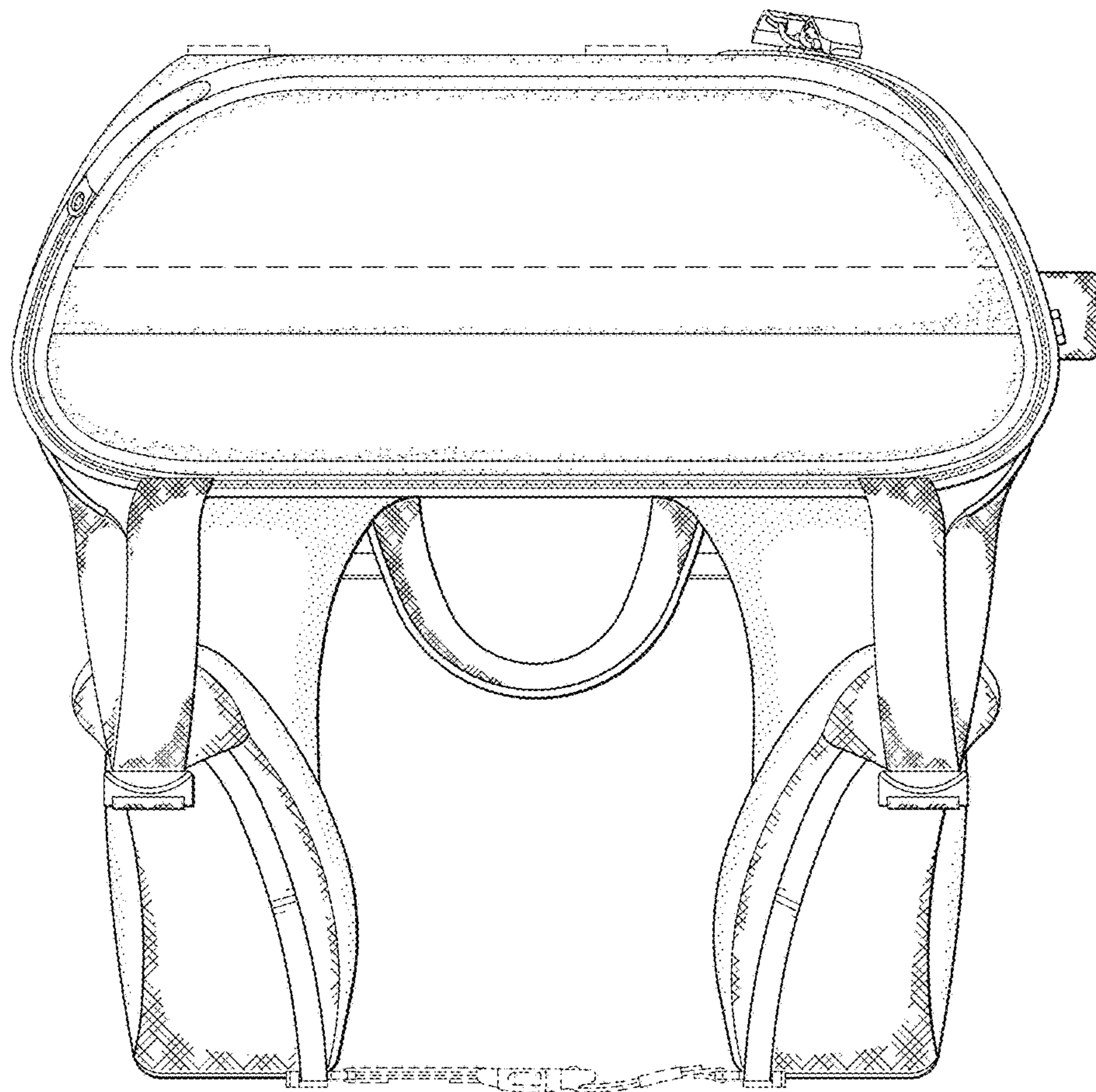

FIG. 7

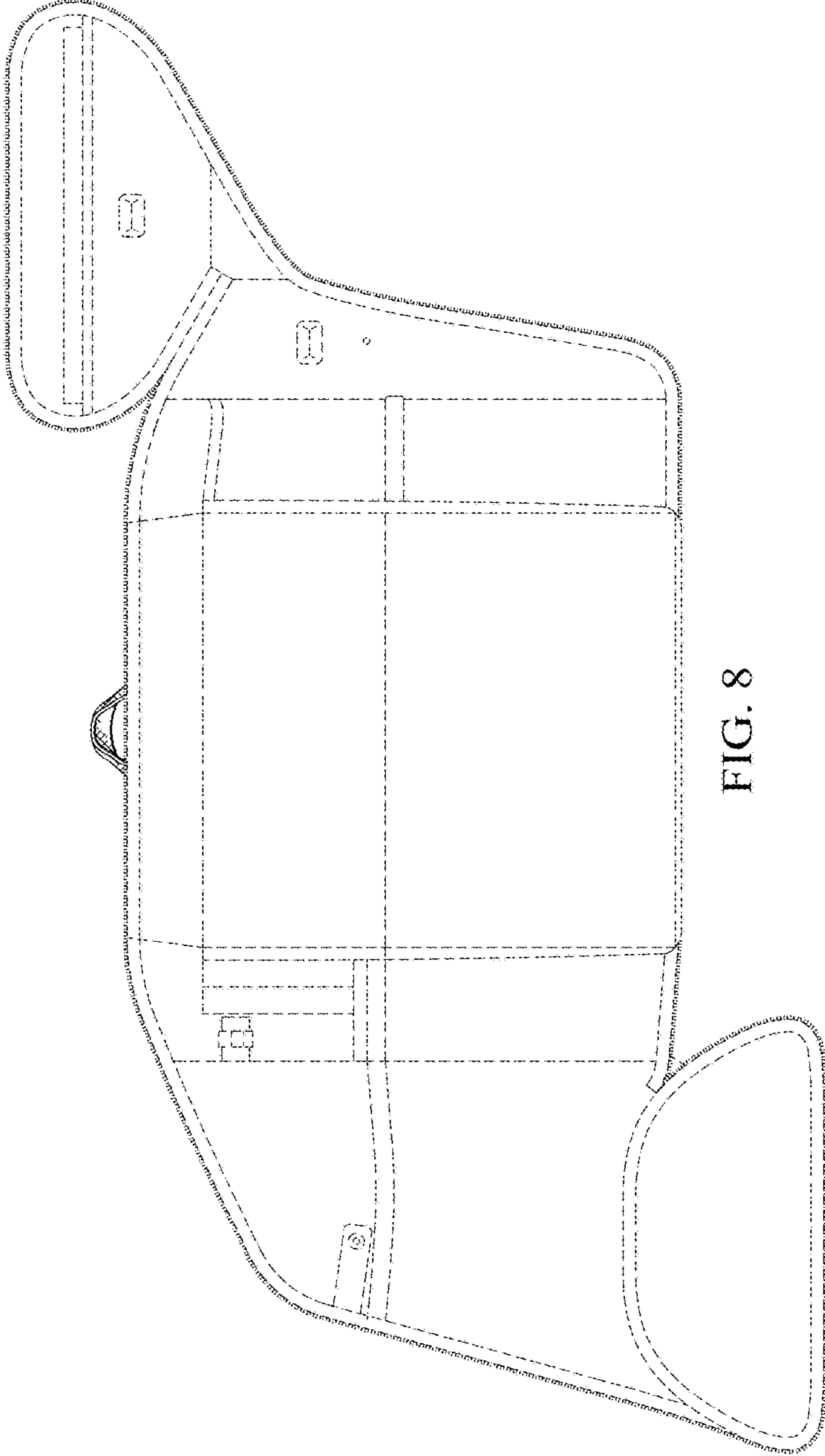

FIG. 8

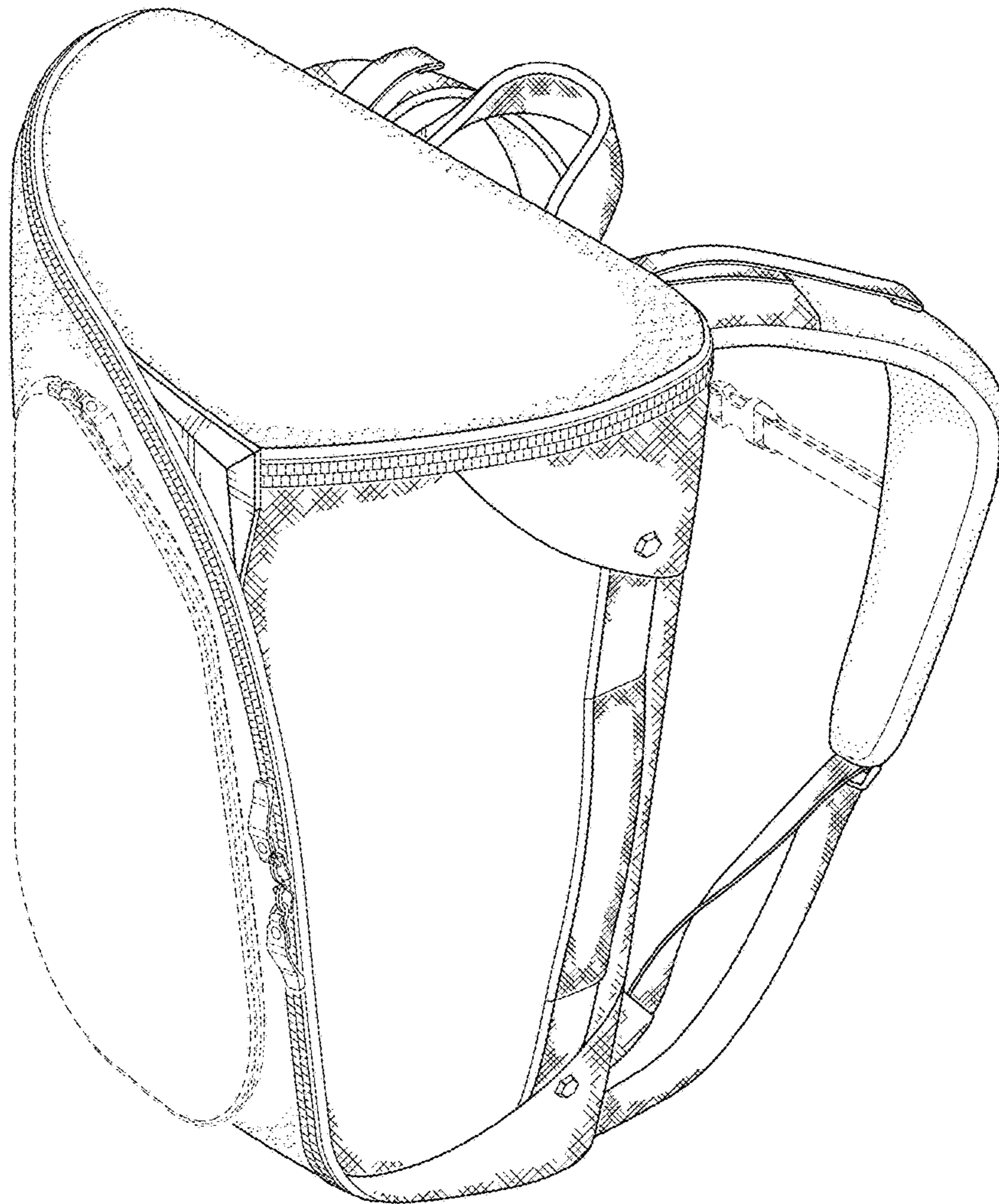

FIG. 9



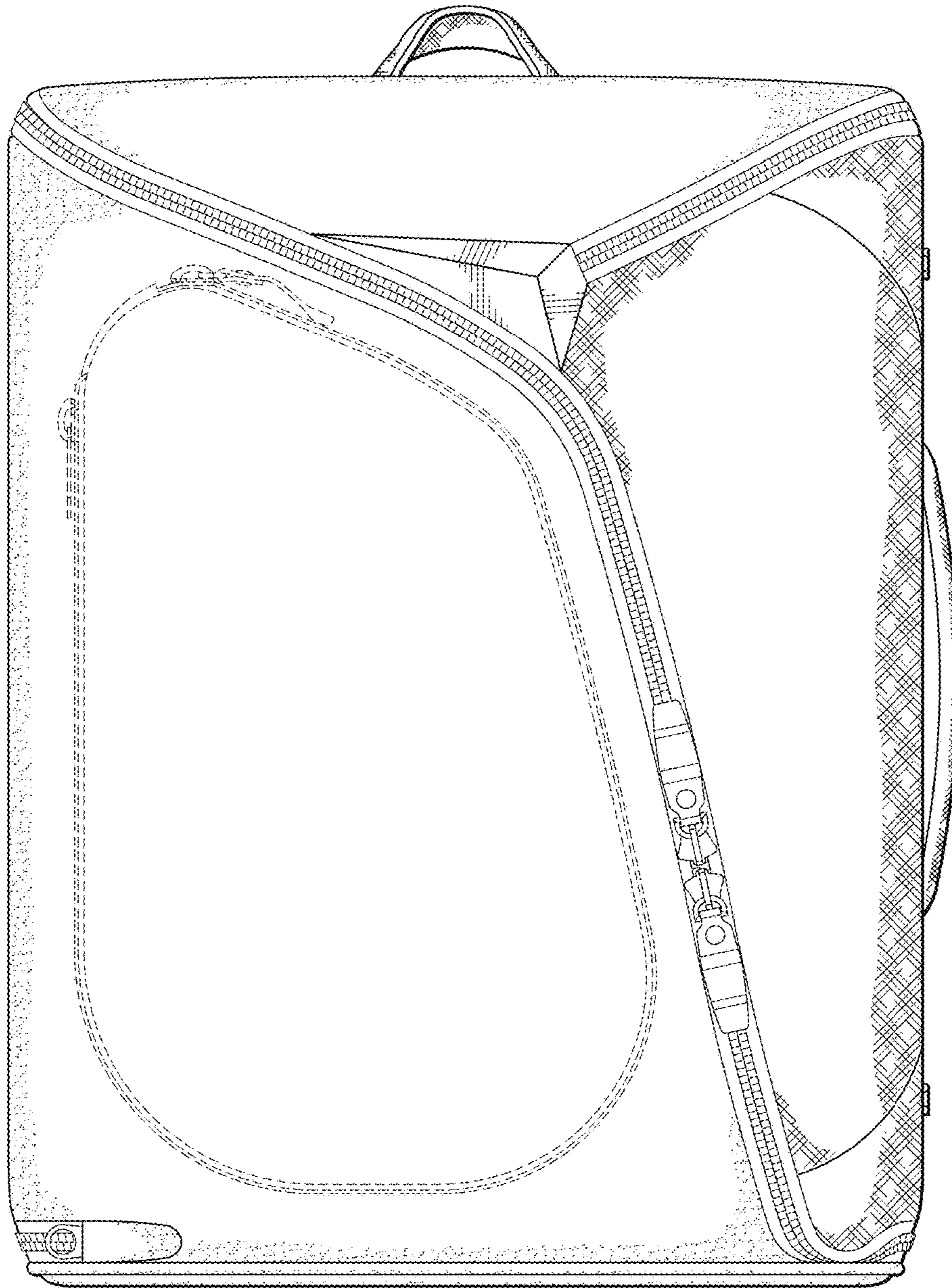

FIG. 10

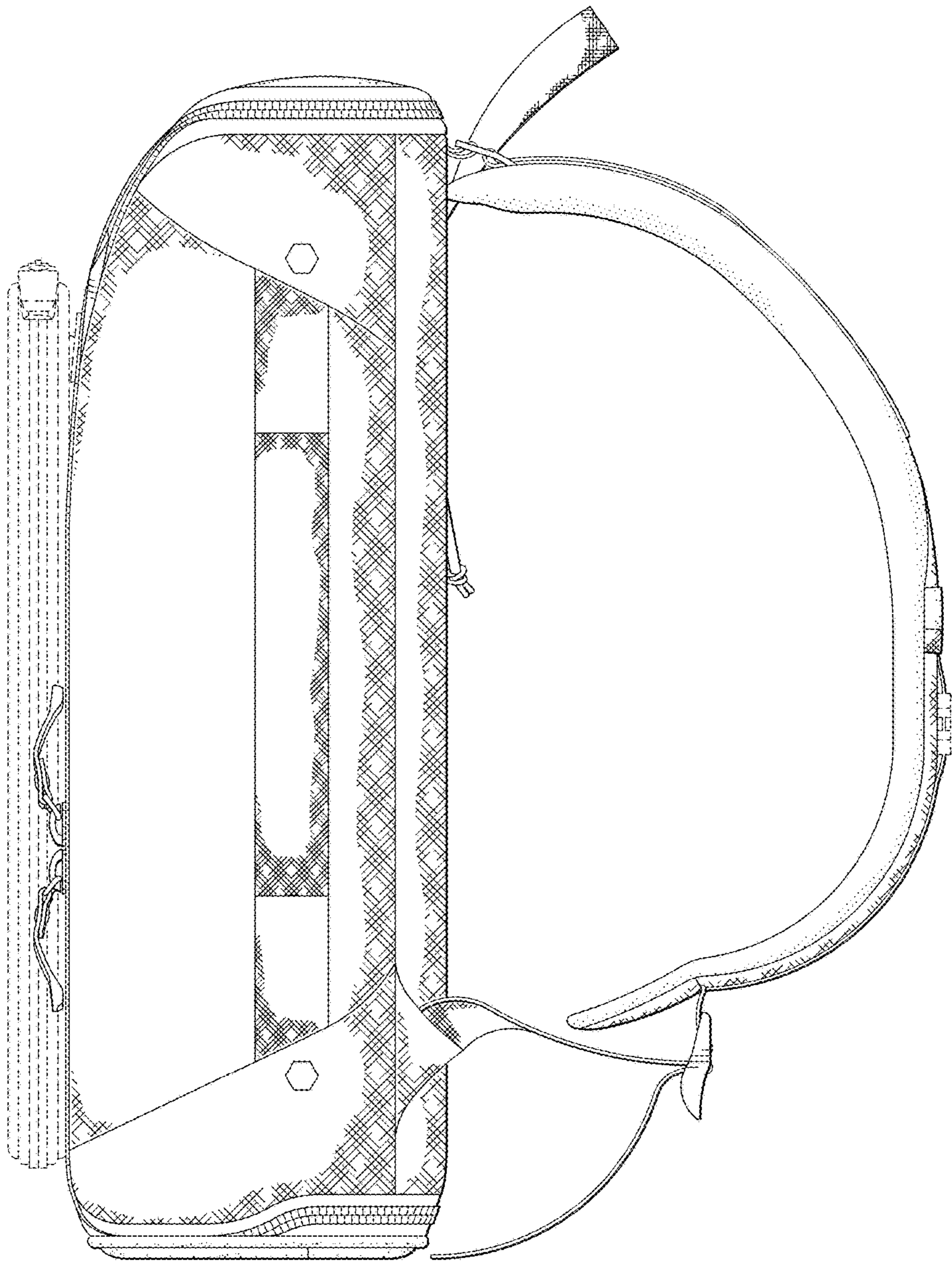

FIG. 11

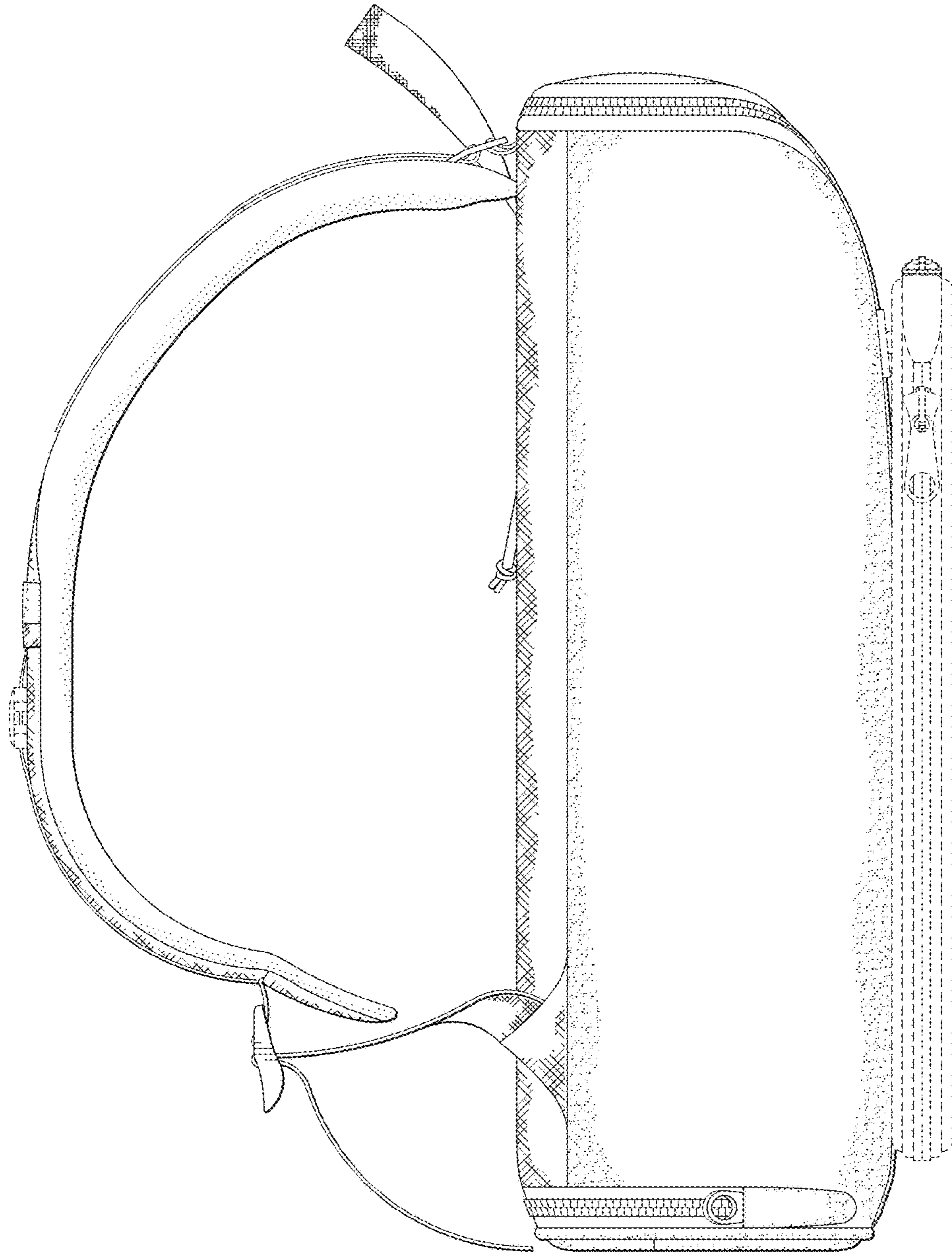

FIG. 12



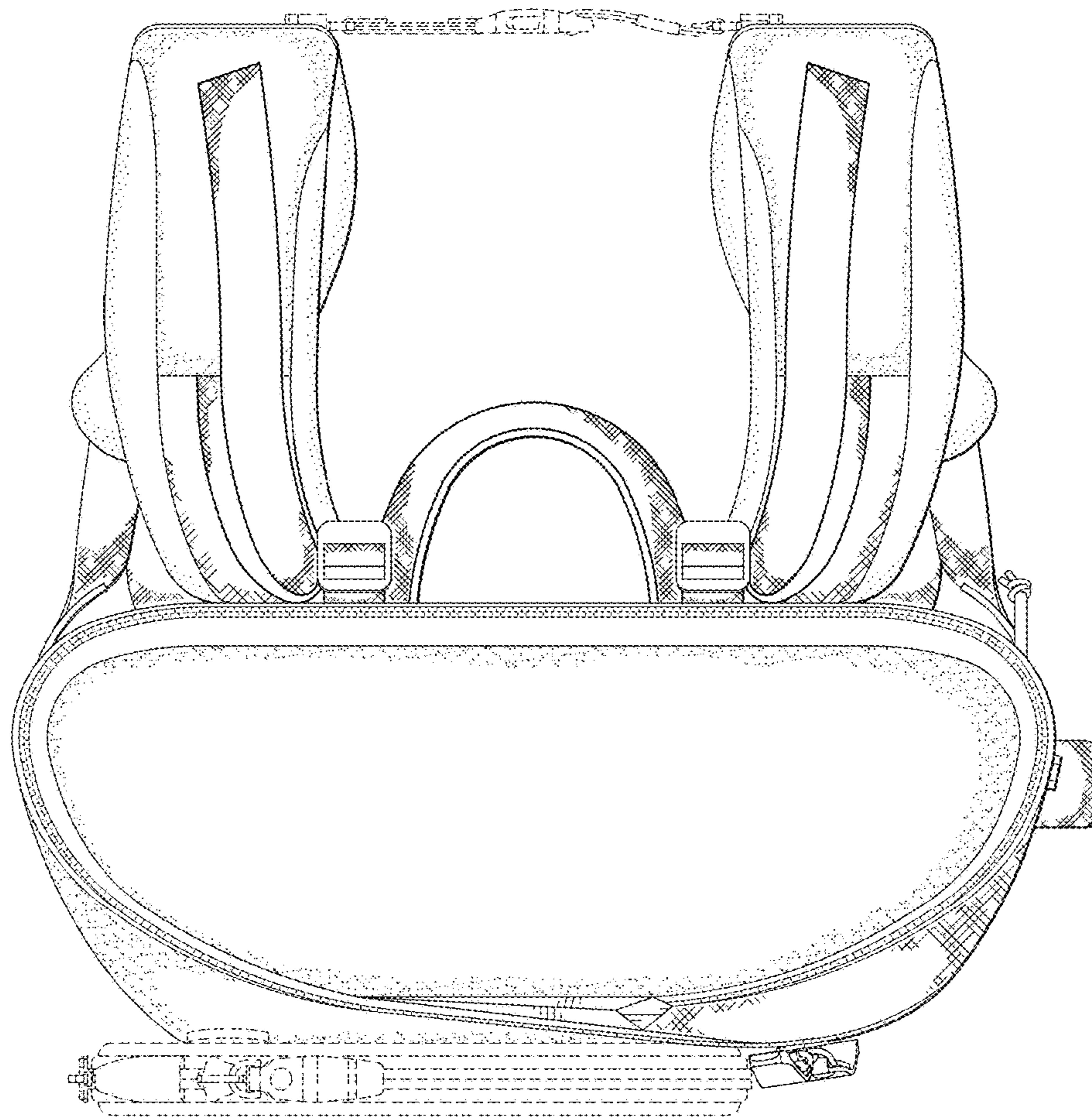

FIG. 13

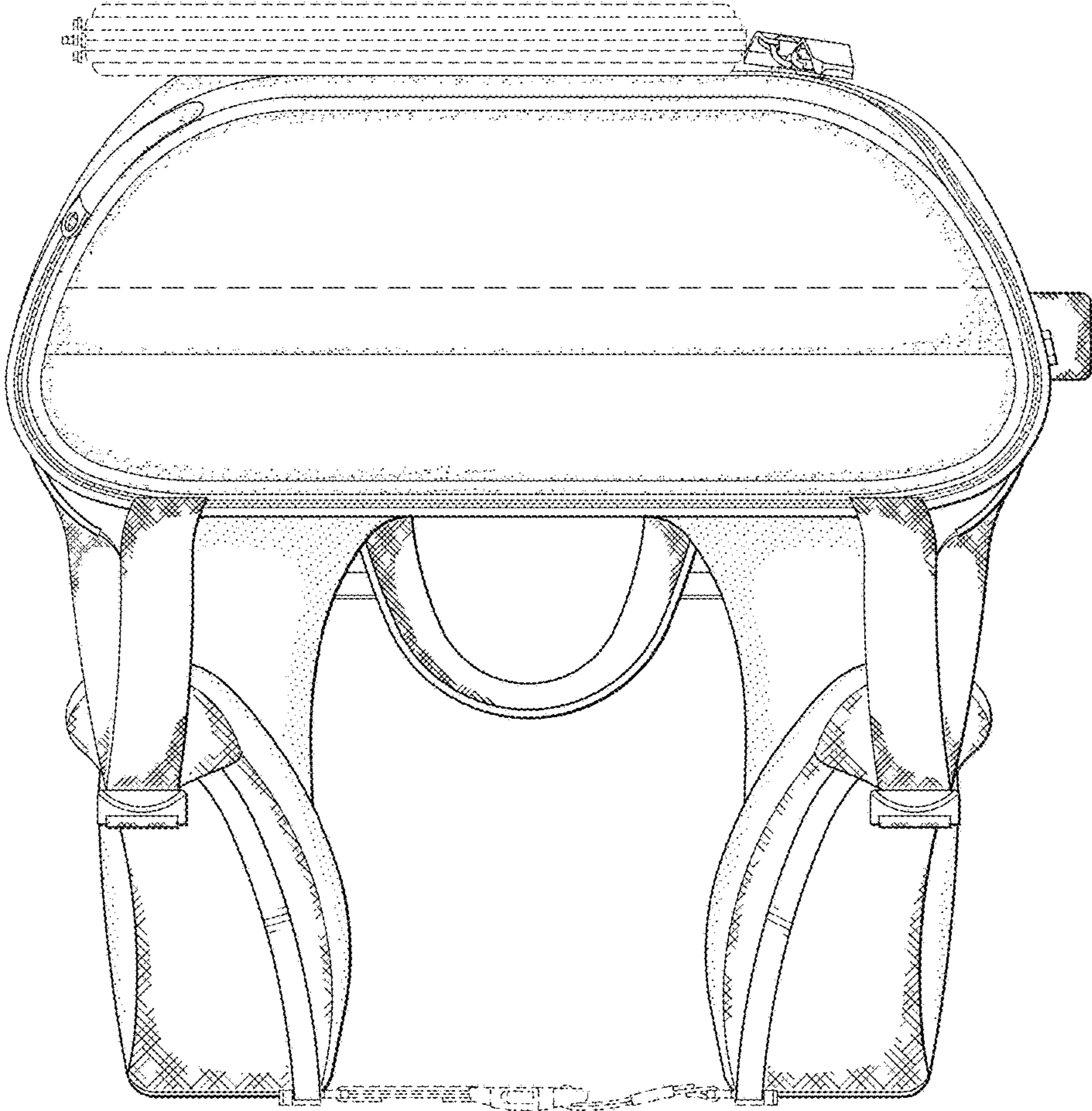

FIG. 14

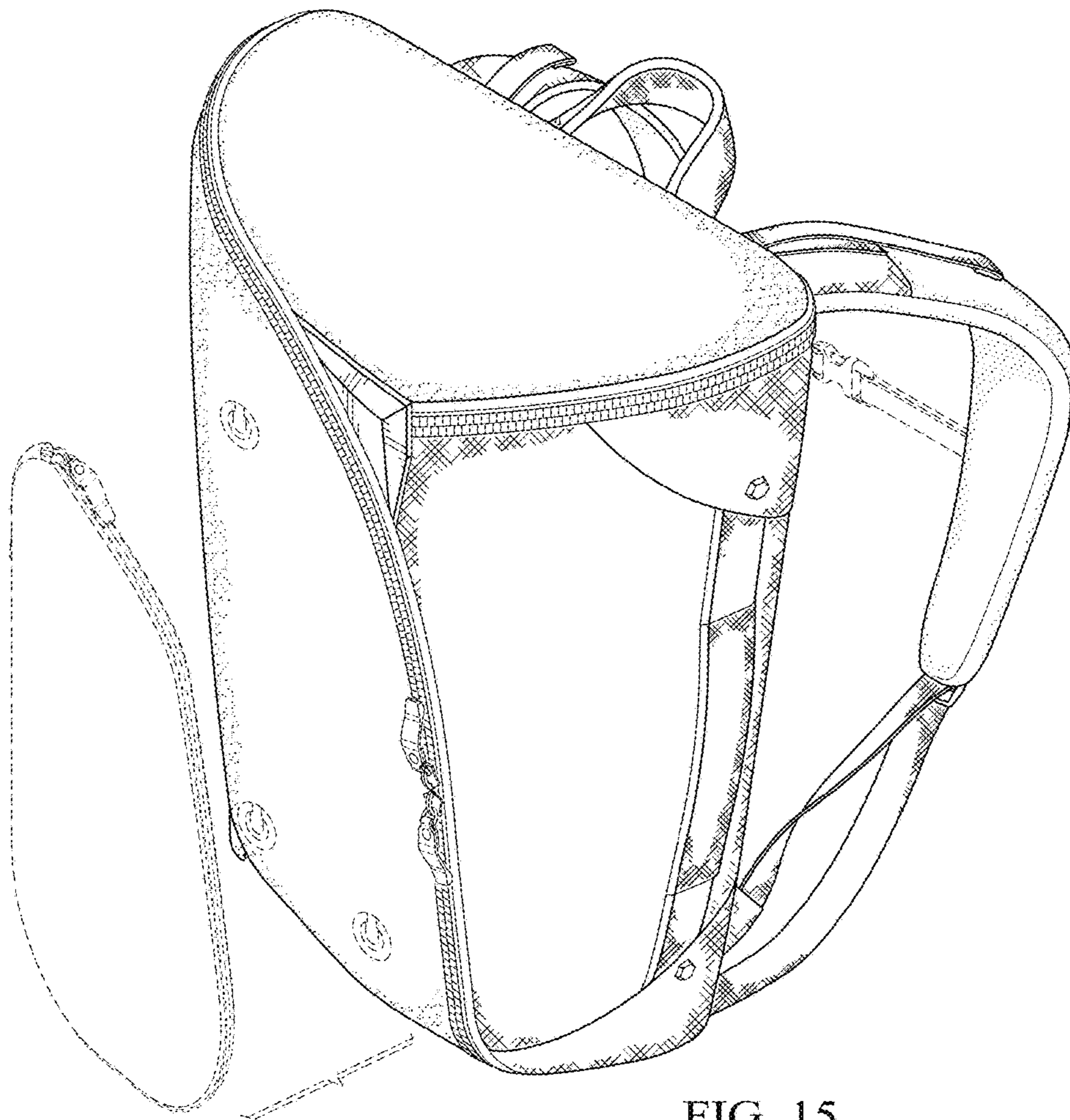

FIG. 15



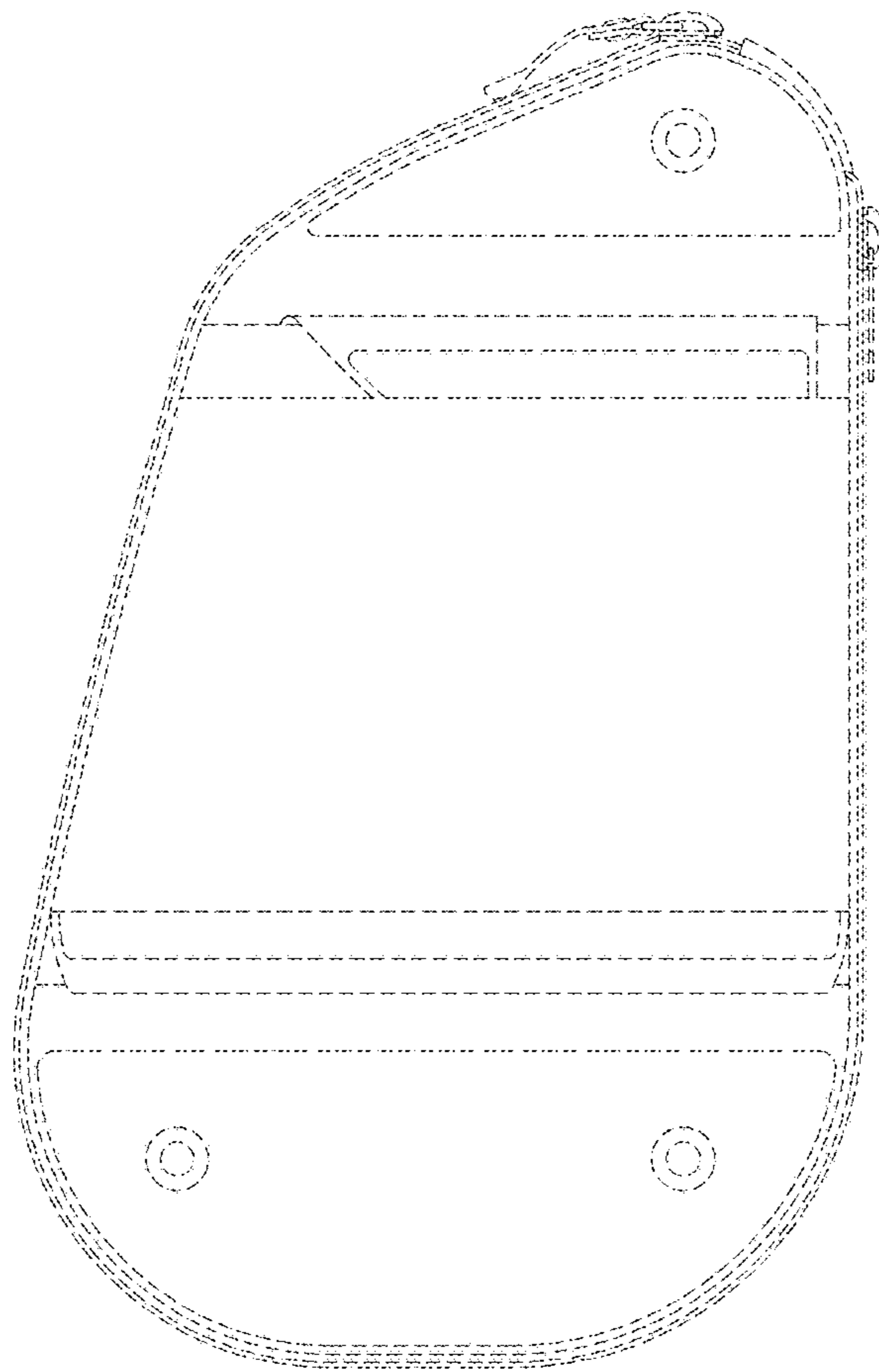

FIG. 16