



US00D854792S

(12) **United States Design Patent**
McLellan et al.

(10) **Patent No.:** **US D854,792 S**
(45) **Date of Patent:** **** Jul. 30, 2019**

- (54) **FOOTWEAR**
- (71) Applicant: **Allbirds, Inc.**, San Francisco, CA (US)
- (72) Inventors: **Jamie S. McLellan**, Auckland (NZ); **Jad Finck**, San Francisco, CA (US); **Timothy O. Brown**, San Francisco, CA (US); **Lisa Halbower-Fenton**, Scituate, MA (US)
- (73) Assignee: **Allbirds, Inc.**, San Francisco, CA (US)
- (**) Term: **15 Years**
- (21) Appl. No.: **29/646,794**
- (22) Filed: **May 7, 2018**
- (51) **LOC (11) Cl.** **02-04**
- (52) **U.S. Cl.**
USPC **D2/917**
- (58) **Field of Classification Search**
USPC D02/896-900, 916-925, 940, 943, 946,
D02/947-952, 969
CPC .. A43B 3/12; A43B 3/10; A43B 3/122; A43B
23/25; A43B 3/103; A43B 1/0027
See application file for complete search history.

(56) **References Cited**

U.S. PATENT DOCUMENTS

- 4,172,330 A * 10/1979 Kao A43B 3/103
36/101
- 5,185,942 A * 2/1993 Decker A43B 3/00
36/1
- D450,177 S * 11/2001 Boncutter D2/916
- 6,904,706 B2 * 6/2005 Jones A43B 1/0027
36/101
- D521,213 S * 5/2006 Jarmon Mouchi D2/946
- D523,214 S * 6/2006 Jarmon Mouchi .. A43B 3/0026
D2/946
- D542,512 S * 5/2007 Krutilek D2/917
- 7,284,341 B2 * 10/2007 Moseley A43B 3/0026
36/103
- D599,089 S * 9/2009 Liow D2/917

- 7,681,330 B2 * 3/2010 Lewis A43B 3/103
36/100
- D613,044 S * 4/2010 Fu D2/917
- 7,694,436 B2 * 4/2010 Mullen A43B 3/103
12/142 Q
- D619,341 S * 7/2010 Fu A43B 3/103
D2/917
- D655,898 S * 3/2012 Mann A43B 3/103
D2/917
- 8,132,342 B1 * 3/2012 Moon A43B 1/0027
36/101
- D664,747 S * 8/2012 Ma A43B 3/103
D2/917

(Continued)

Primary Examiner — Rashida C. Walshon

(74) *Attorney, Agent, or Firm* — Schwabe, Williamson & Wyatt, P.C.

(57) **CLAIM**

We claim the ornamental design for footwear, as shown and described.

DESCRIPTION

FIG. 1 is a perspective view of footwear, showing our new design;
 FIG. 2 is a right side view thereof;
 FIG. 3 is a left side view thereof;
 FIG. 4 is a front view thereof;
 FIG. 5 is a back view thereof;
 FIG. 6 is a top view thereof;
 FIG. 7 is a bottom view thereof;
 FIG. 8 is a perspective view thereof, with the strap shown partially detached from the sole of the footwear; and,
 FIG. 9 is a bottom perspective view thereof, with the strap shown detached from the sole of the footwear.
 The dashed line patterning on the top and bottom of the sole are included for illustrating environmental structure and form no part of the claimed design.

1 Claim, 7 Drawing Sheets

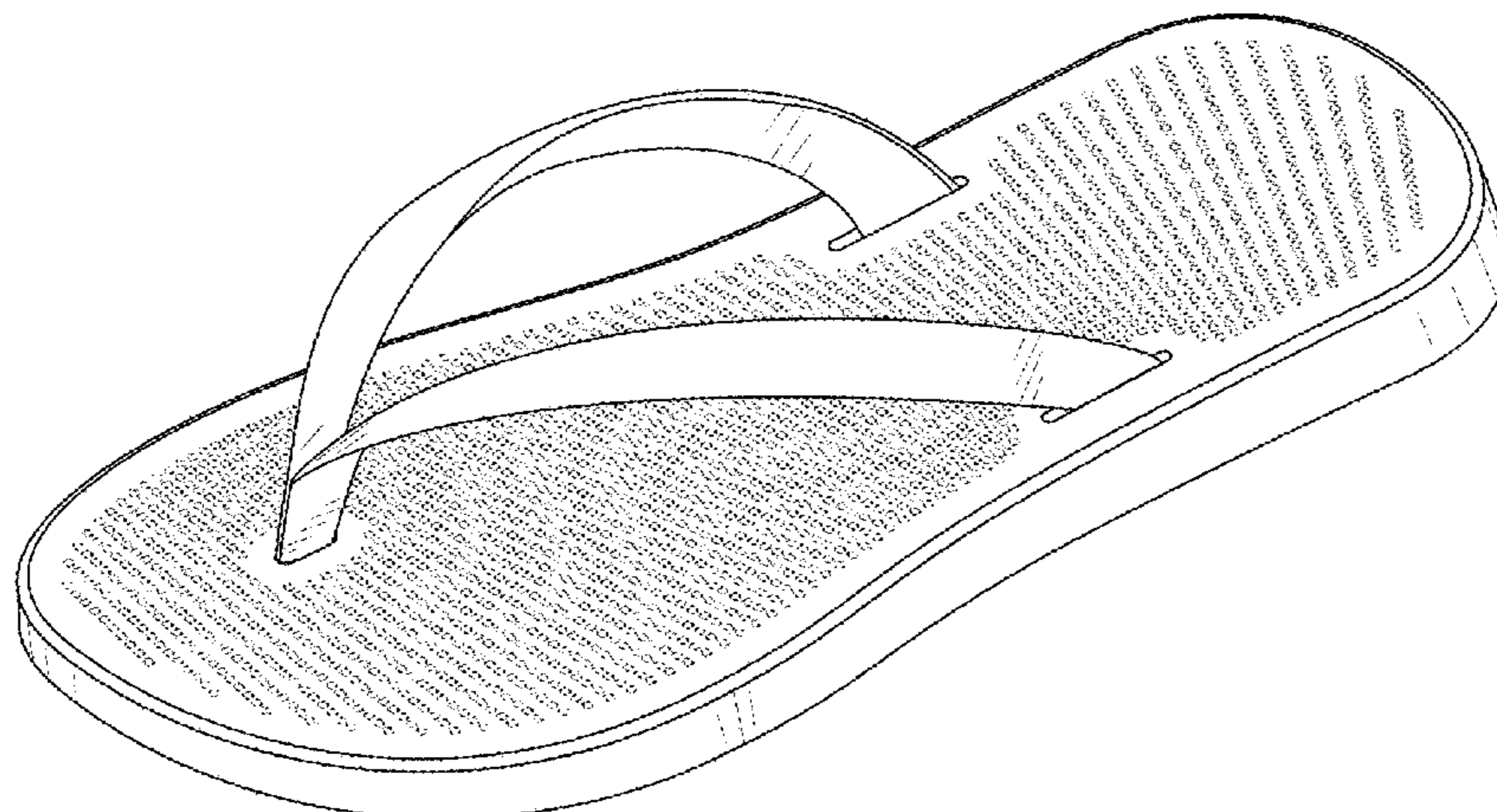

(56)

References Cited

U.S. PATENT DOCUMENTS

D753,907 S * 4/2016 Zavodny A43B 3/103
D2/917
9,380,836 B1 * 7/2016 Vigil A43B 3/103
9,788,610 B2 * 10/2017 Canei A43B 3/103

* cited by examiner

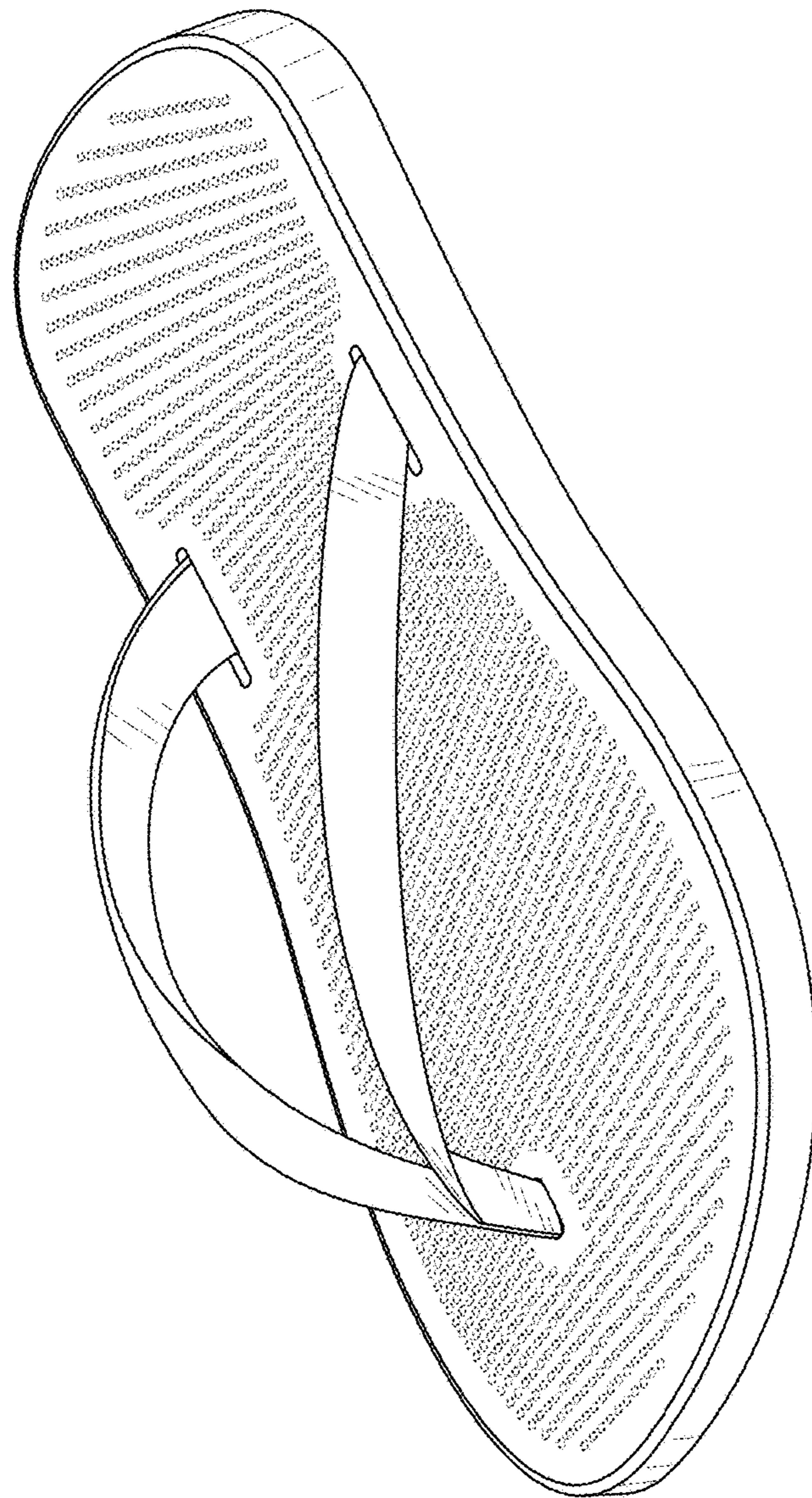

FIG. 1

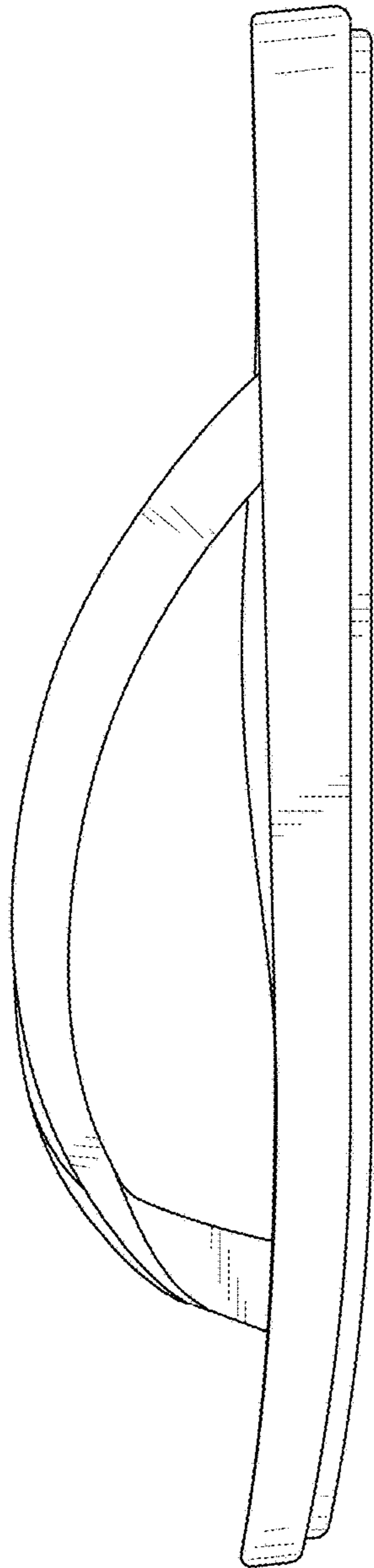

FIG. 2

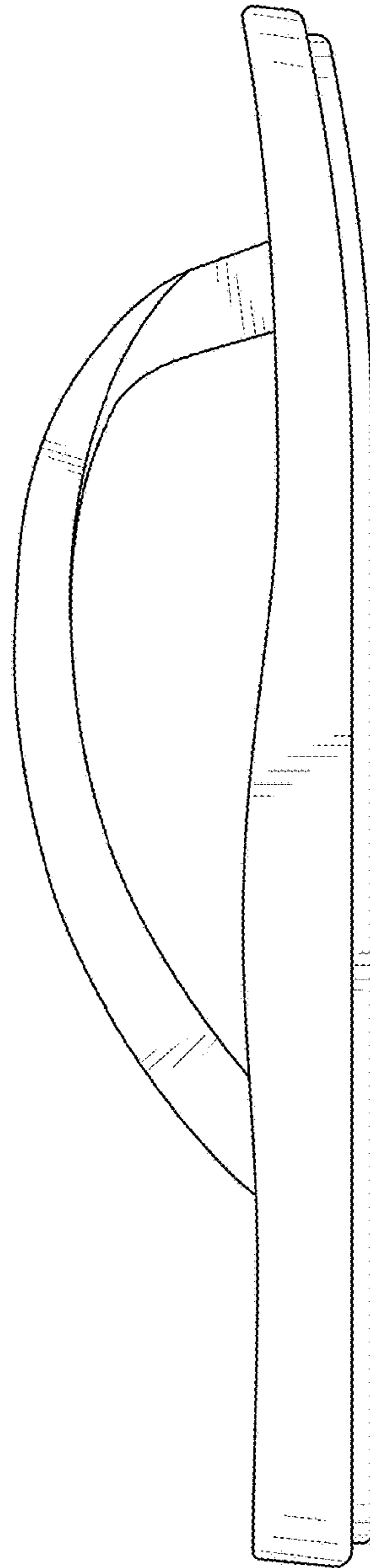

FIG. 3

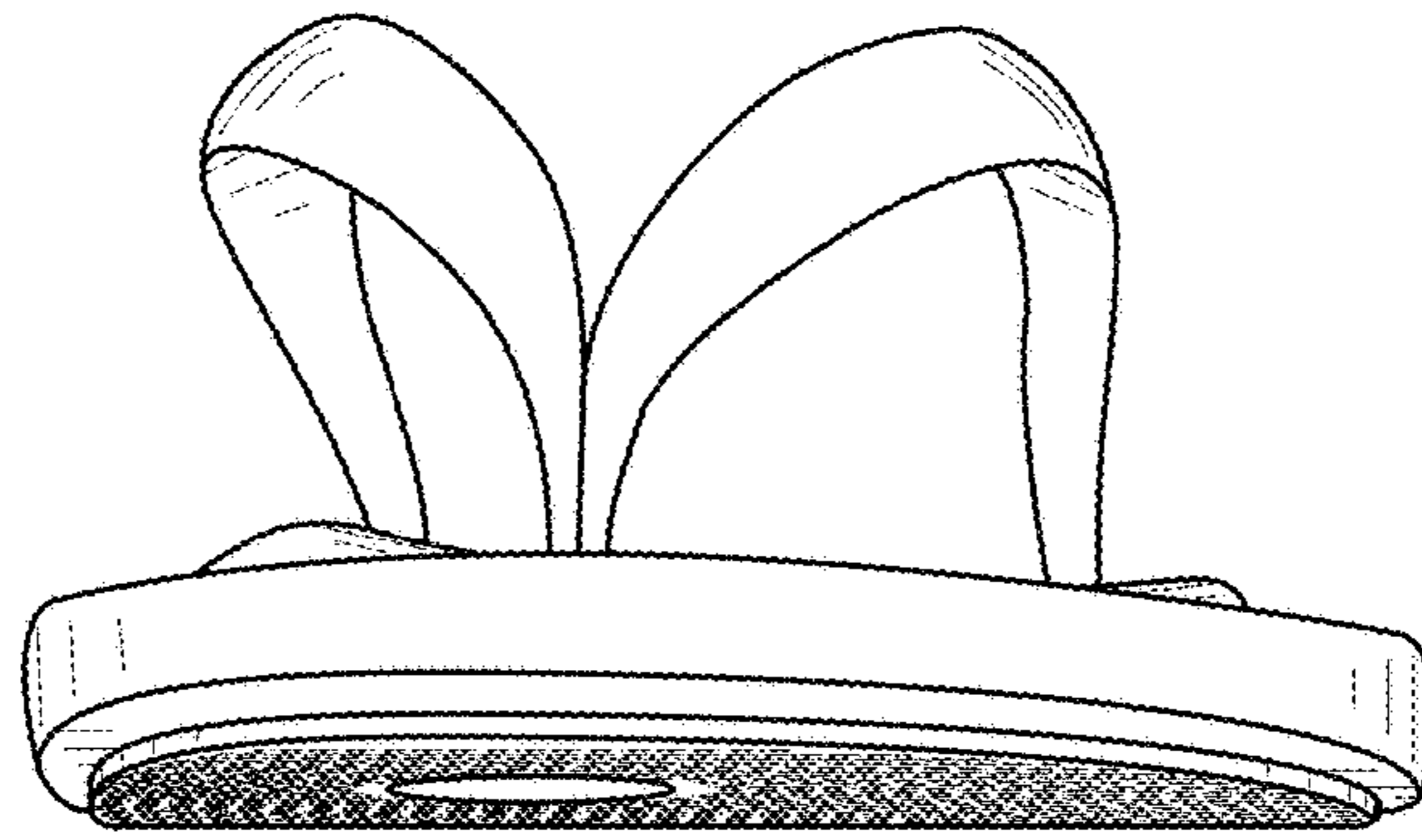

FIG. 4

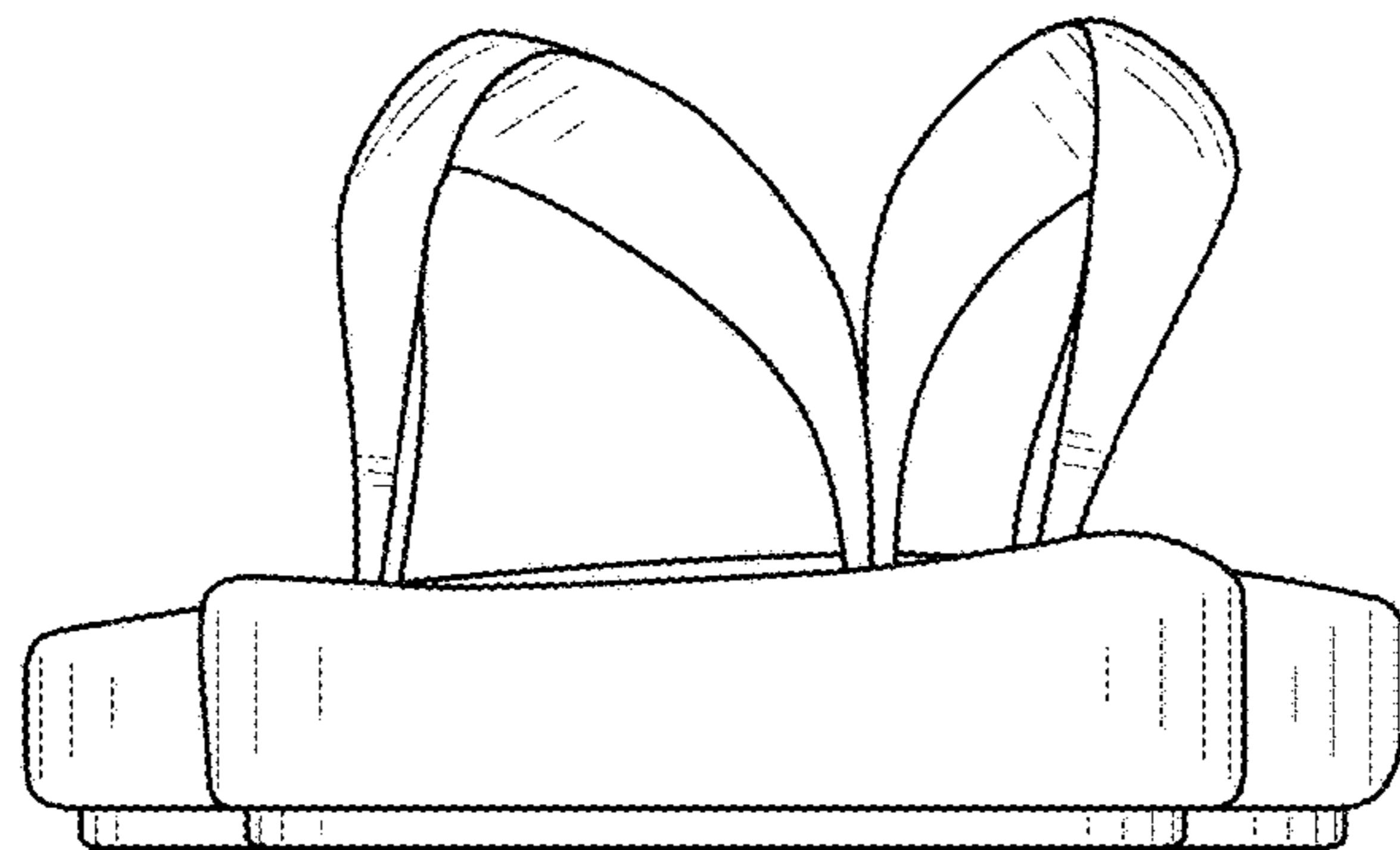

FIG. 5

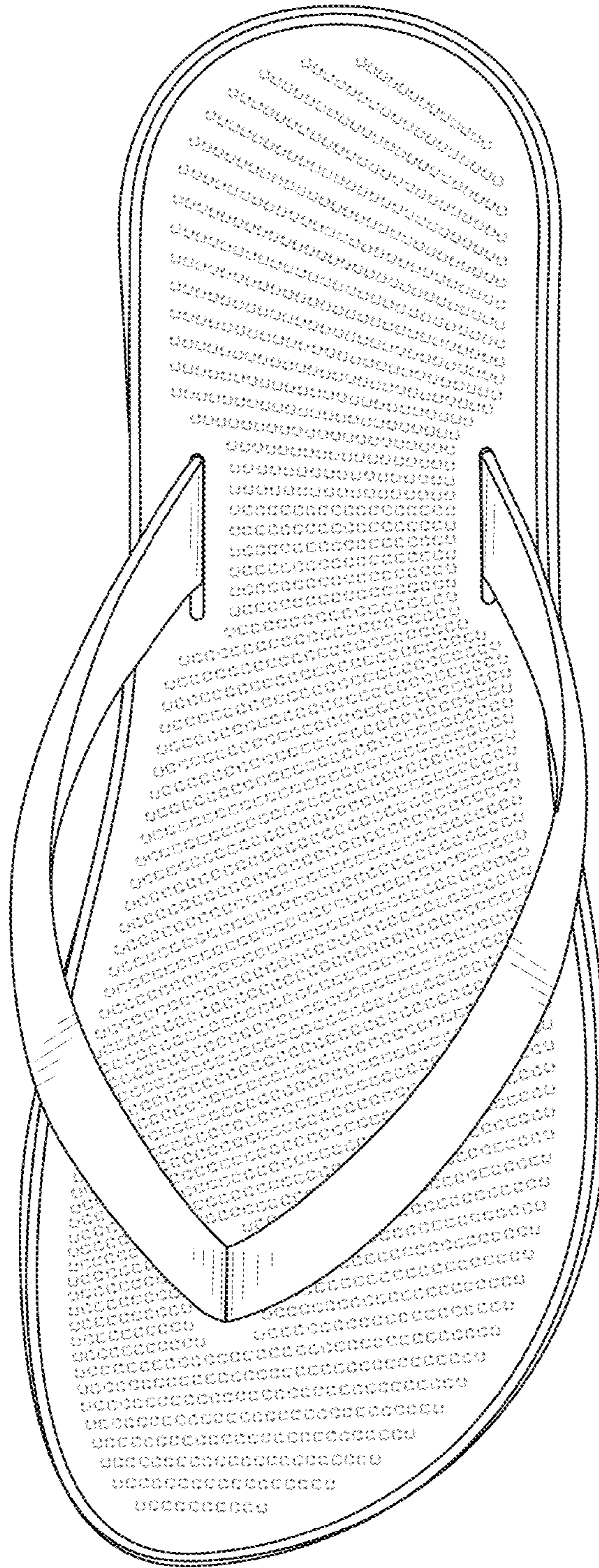

FIG. 6

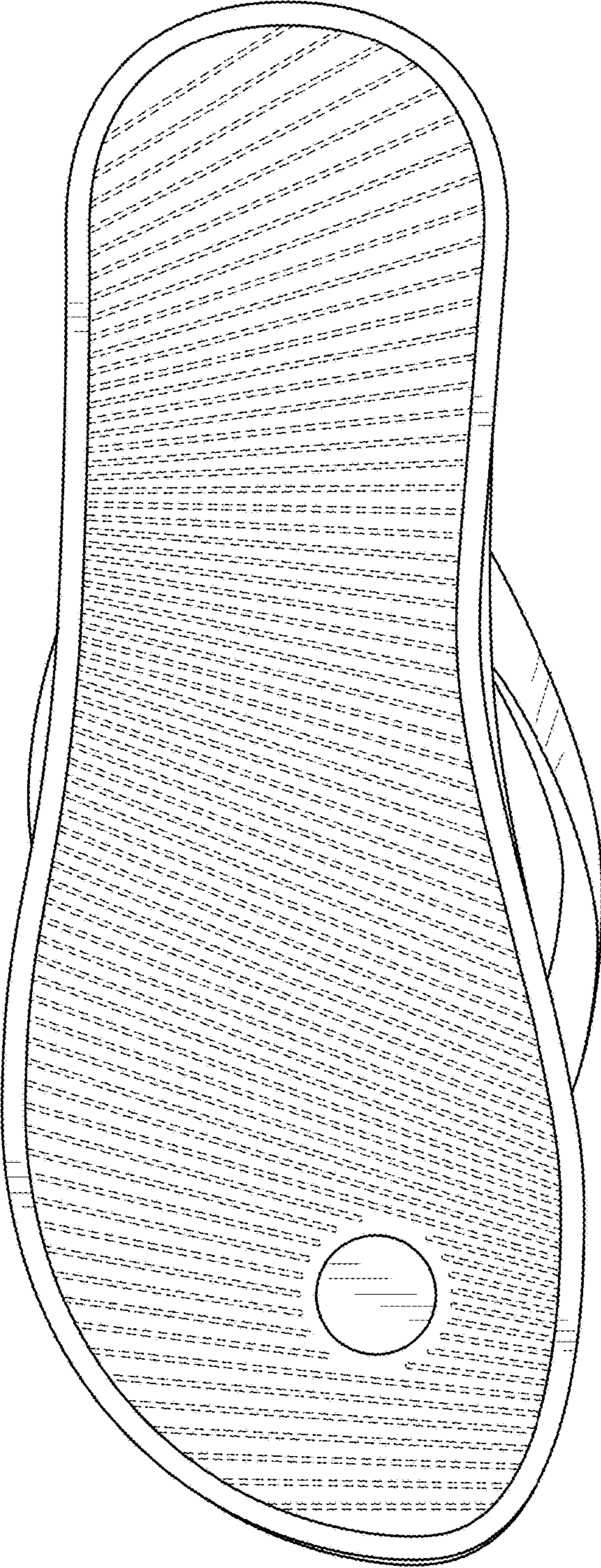

FIG. 7

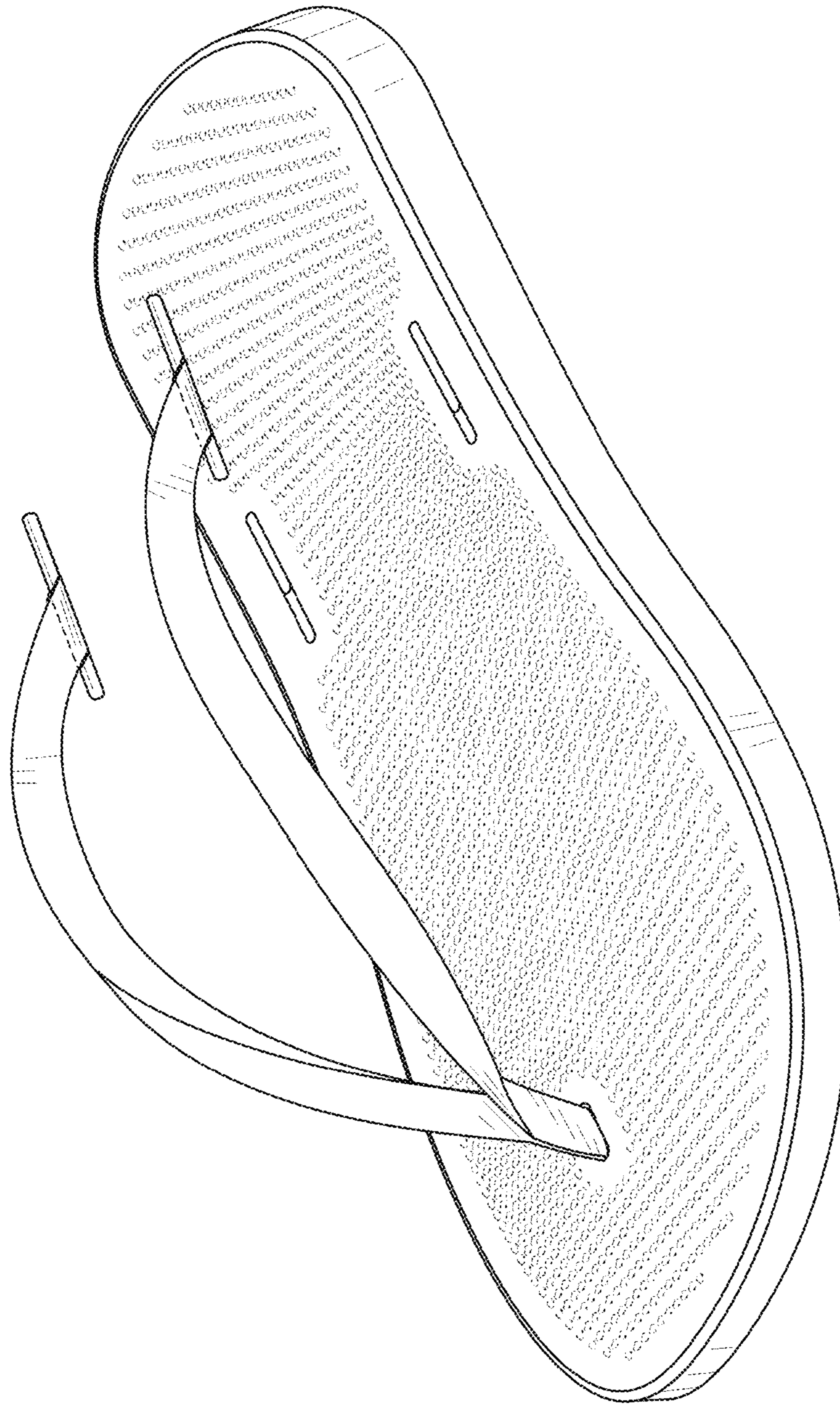

FIG. 8

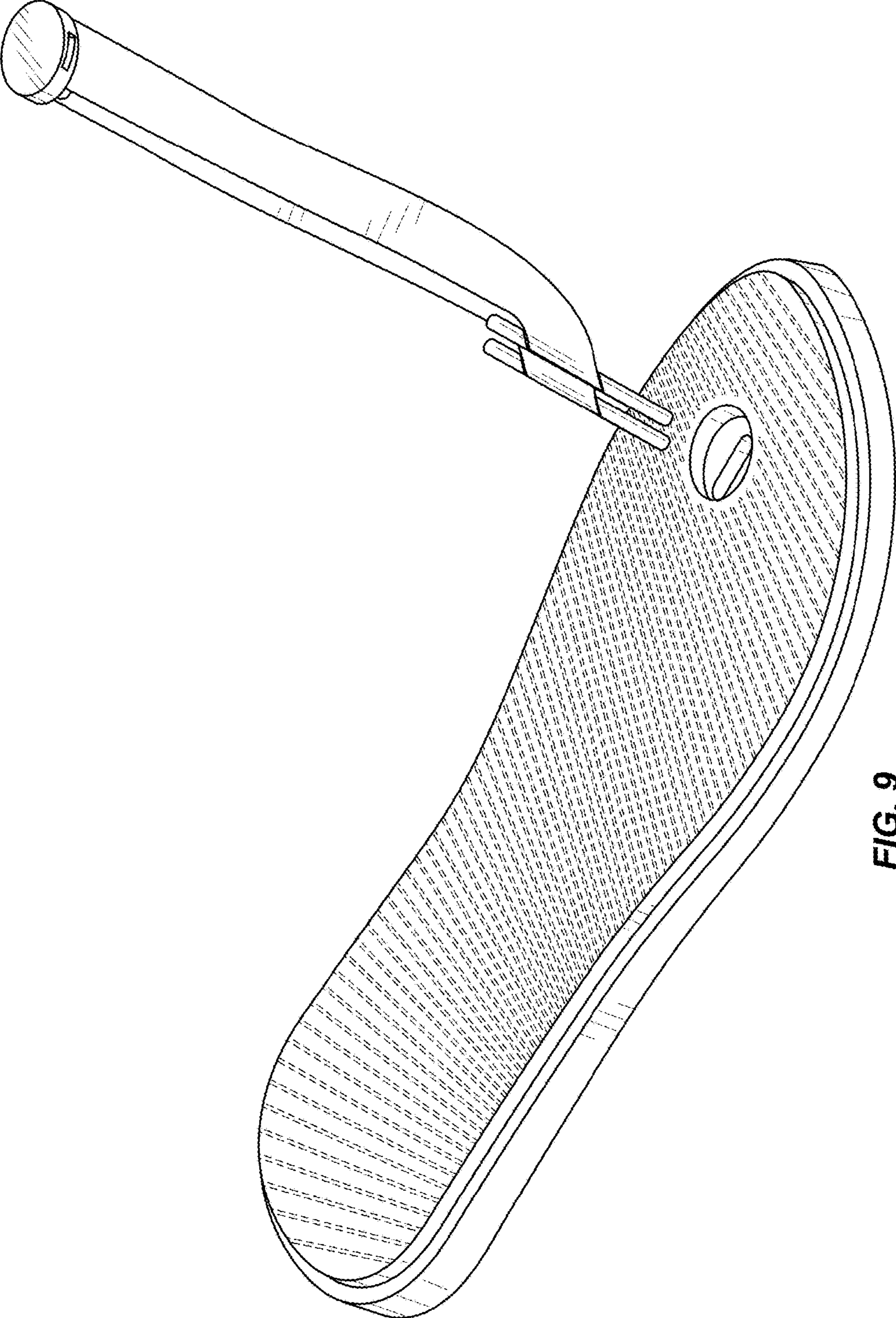

FIG. 9