



US00D854766S

(12) **United States Design Patent**
Choi et al.

(10) **Patent No.:** **US D854,766 S**
(45) **Date of Patent:** **** Jul. 23, 2019**

(54) **PADDLE LIGHTER FOR WASHING MACHINE**

(71) Applicant: **Samsung Eledctronics Co., Ltd.**,
Suwon-si (KR)

(72) Inventors: **Jung-Ah Choi**, Seoul (KR); **Jin-Nam Kim**, Seoul (KR); **Sung-Kyung Lee**, Seoul (KR); **Eui-Ju Lee**, Guri-si (KR)

(73) Assignee: **Samsung Electronics Co., Ltd.**,
Suwon-si (KR)

(**) Term: **15 Years**

(21) Appl. No.: **29/616,937**

(22) Filed: **Sep. 11, 2017**

(30) **Foreign Application Priority Data**

Apr. 25, 2017 (KR) 30-2017-0019086

(51) **LOC (11) Cl.** **15-05**

(52) **U.S. Cl.**
USPC **D32/26; D32/25**

(58) **Field of Classification Search**
USPC D32/25, 26; 34/87-88, 523-524, 599,
34/602, 606, 610; 68/3 R, 5 R, 12.01,
68/17 A, 24, 58, 133-134; 8/147, 158;
210/356; 137/512.15; 392/379, 384;
D8/402

(Continued)

(56) **References Cited**

U.S. PATENT DOCUMENTS

D571,966 S * 6/2008 Reim D32/26
D572,870 S * 7/2008 Reim D32/26

(Continued)

FOREIGN PATENT DOCUMENTS

CN 301890605 * 4/2012
EM 000684311-0001 4/2007

(Continued)

OTHER PUBLICATIONS

Drum Baffle Washing Machine posted by Frigidaire posted date Apr. 4, 2014, © Amazon, [online], [site visited Jan. 15, 2019]. Available from Internet, <https://www.amazon.com/Frigidaire-134952702-Baffle-Washing-Machine> (Year: 2014).*

(Continued)

Primary Examiner — Cynthia Rmairez

Assistant Examiner — Laura H Yu

(74) *Attorney, Agent, or Firm* — NSIP Law

(57) **CLAIM**

We claim the ornamental design for a paddle lifter for washing machine, as shown and described.

DESCRIPTION

FIG. 1 is a front perspective view of a paddle lifter for washing machine showing our new design; FIG. 2 is a front elevational view thereof; FIG. 3 is a rear elevational view thereof; FIG. 4 is a left-side elevational view thereof; FIG. 5 is a right-side elevational view thereof; FIG. 6 is a top plan view thereof; FIG. 7 is a bottom plan view thereof; FIG. 8 is rear perspective view thereof; and, FIG. 9 is another perspective view of the paddle lifter for washing machine in use.

The broken lines in the figures illustrate portions of the paddle lifter for washing machine that form no part of the claimed design. The broken lines in FIG. 9 of a washing machine illustrate environment and form no part of the claimed design.

1 Claim, 6 Drawing Sheets

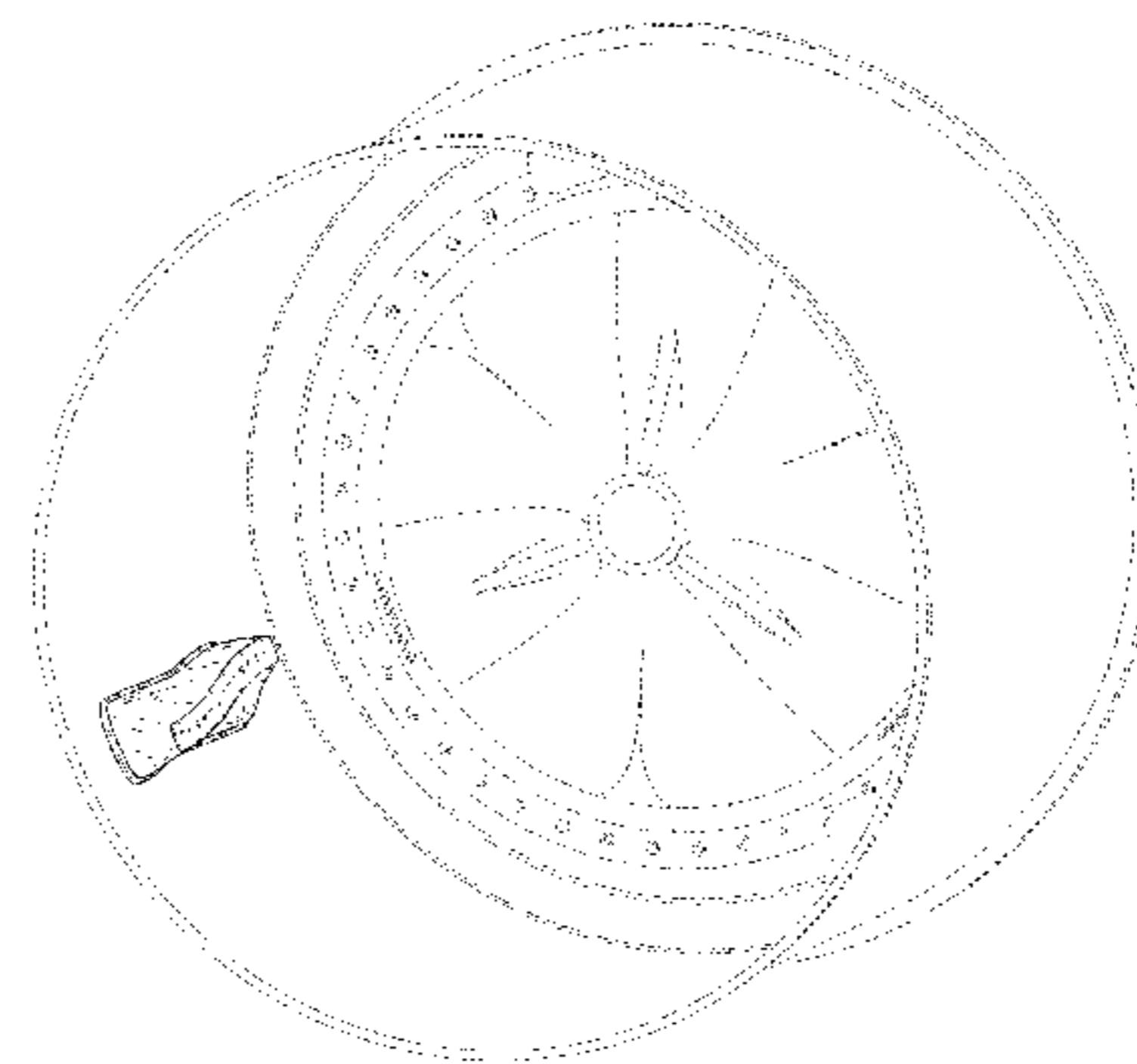
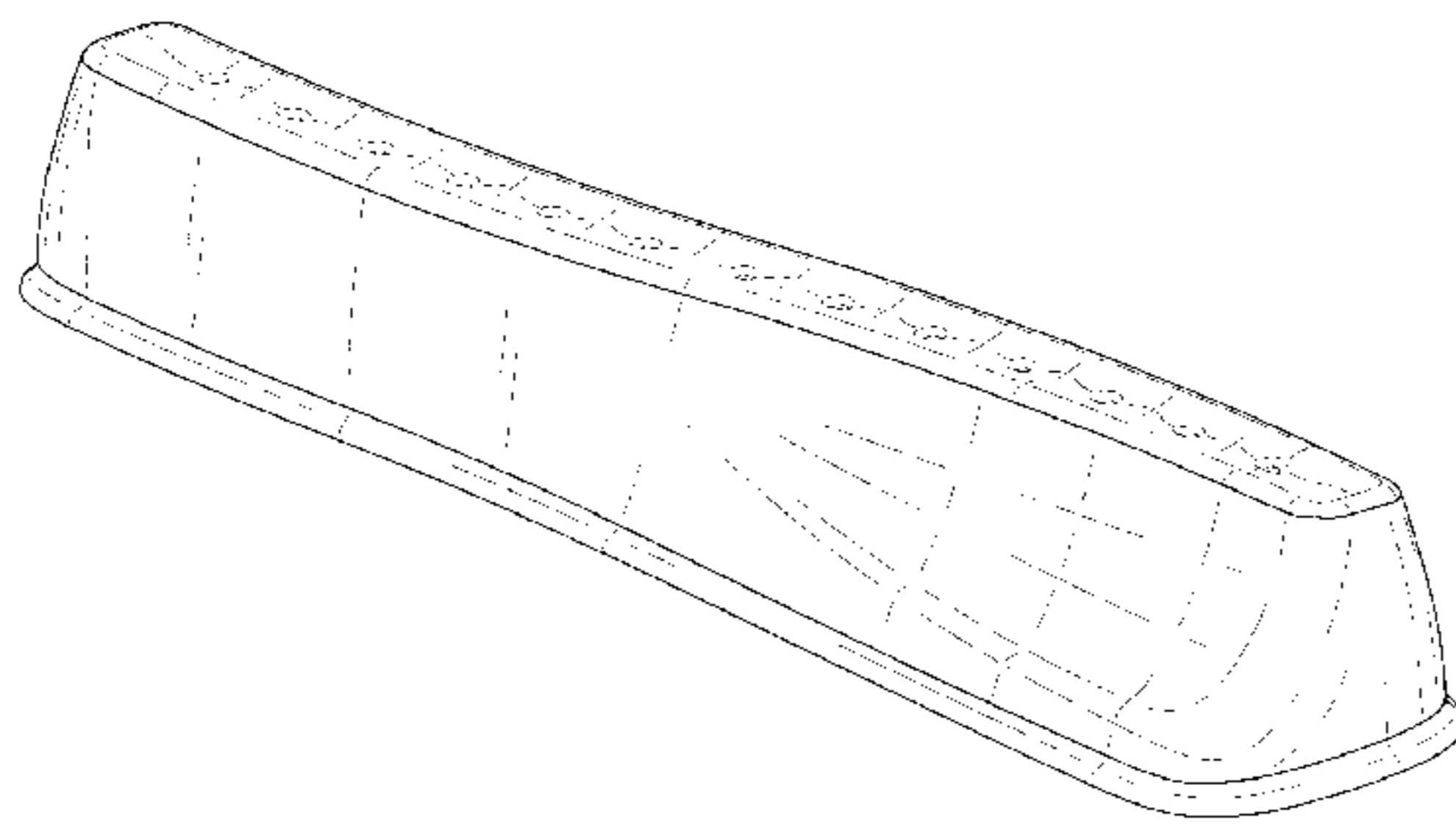

US D854,766 S

Page 2

(58) **Field of Classification Search**

CPC D06F 39/008; D06F 39/08; D06F 29/00;
D06F 29/005

See application file for complete search history.

D720,902 S * 1/2015 Bangle D32/29
2014/0076004 A1* 3/2014 Lee D06F 17/10
68/134
2015/0027173 A1* 1/2015 Wu D06F 39/024
68/233

(56)

References Cited

U.S. PATENT DOCUMENTS

D577,469 S * 9/2008 Reim D32/26
D602,339 S * 10/2009 Frankel D8/343
D617,513 S * 6/2010 Still D32/29.1
8,065,816 B2 * 11/2011 Ricklefs D06F 58/04
137/512.15
8,256,248 B2 * 9/2012 Jeong D06F 37/02
68/142
D681,891 S * 5/2013 Bign D32/26
D700,411 S * 2/2014 Ha D32/29
8,739,576 B2 * 6/2014 Tobi D06F 25/00
68/3 R

FOREIGN PATENT DOCUMENTS

JP D1300449 5/2007
KR 30-2009-0055009 11/2010
KR 30-2011-0002464 9/2012
RU 00083303 * 10/2012

OTHER PUBLICATIONS

Washing Machine Drum Baffle posted by Whirlpool posted date Apr. 4, 2016, © Amazon, [online], [site visited Jan. 15, 2019]. Available from Internet, <https://www.amazon.co.uk/WHIRPOOL-Washing-Machine-PADDLE> (Year: 2016).*

* cited by examiner

FIG. 1

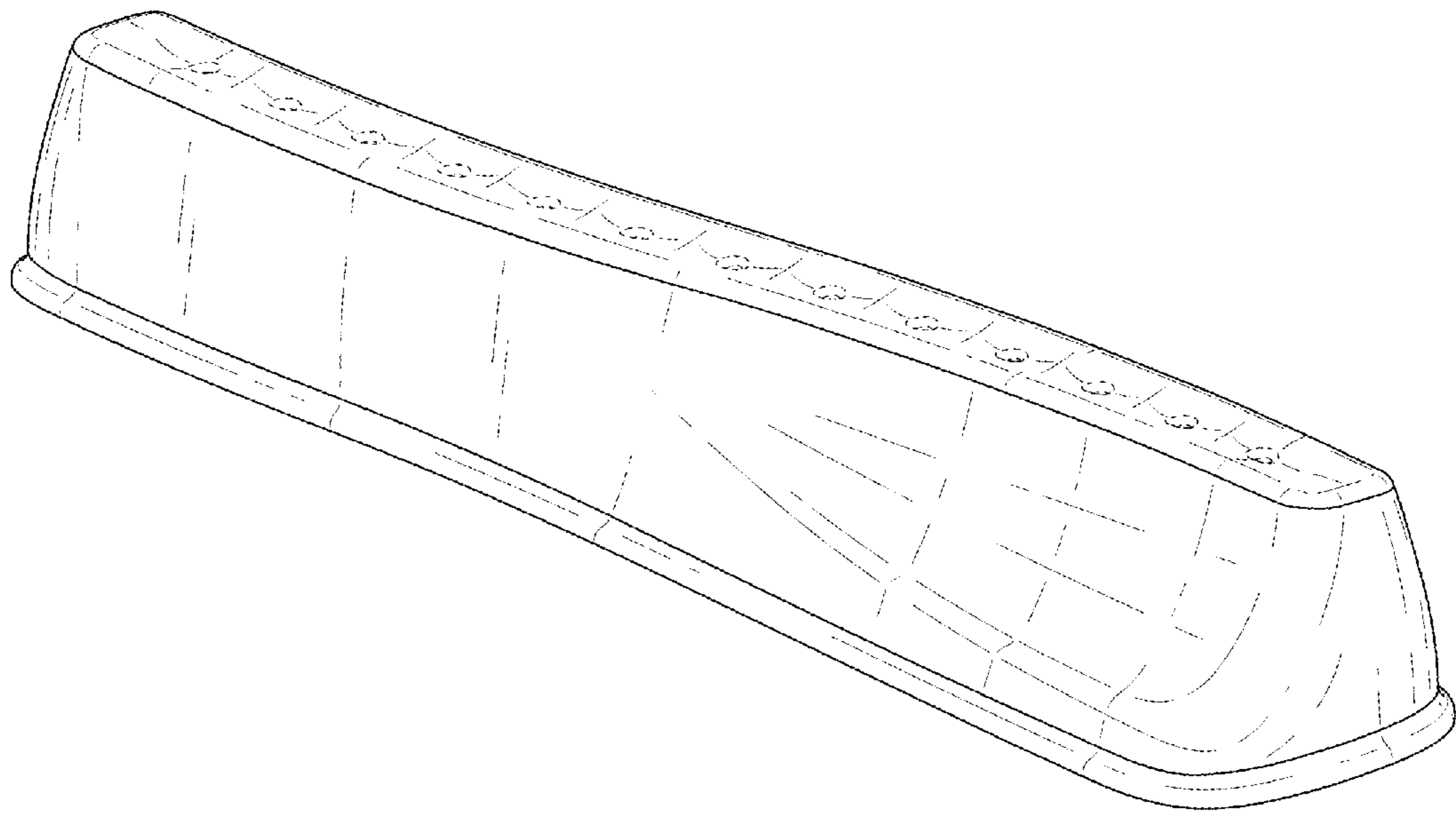

FIG. 2

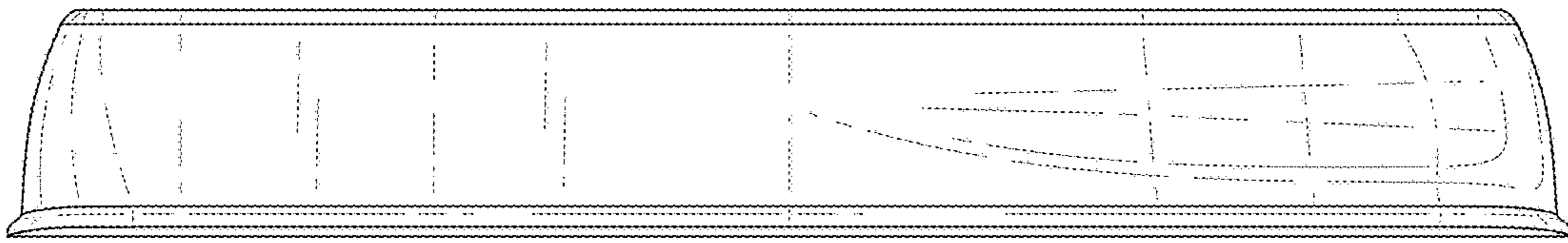

FIG. 3

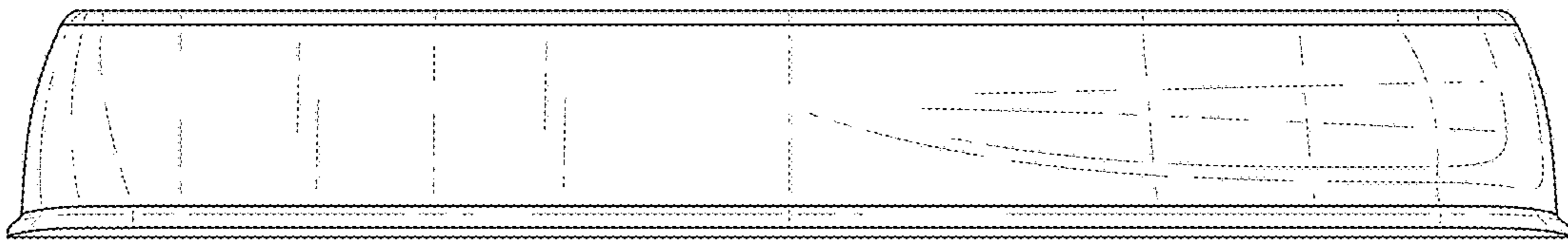

FIG. 4

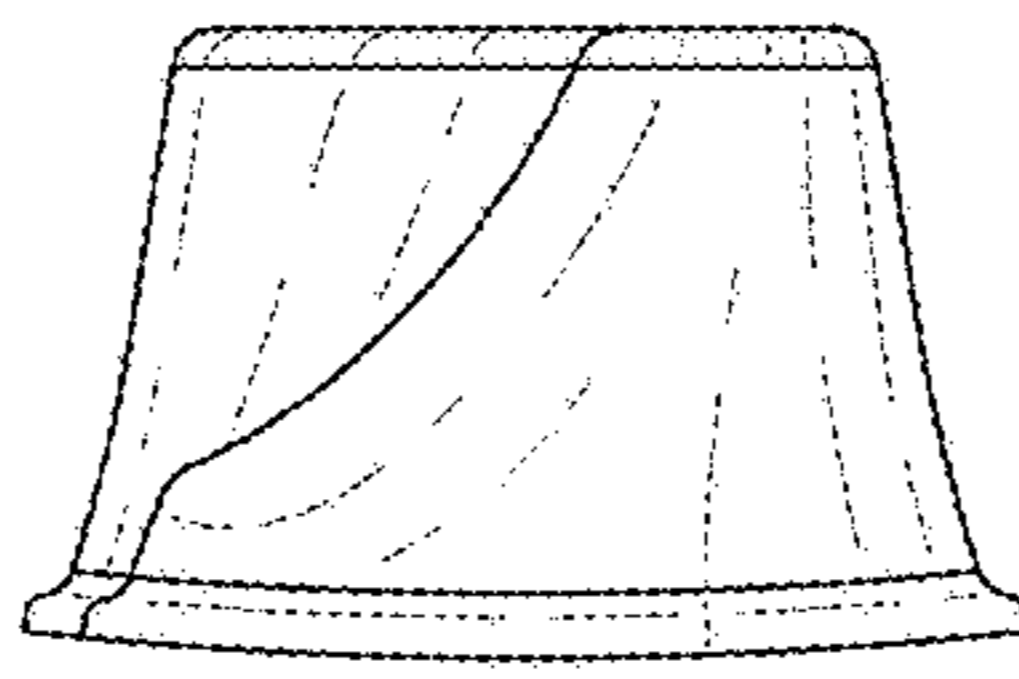

FIG. 5

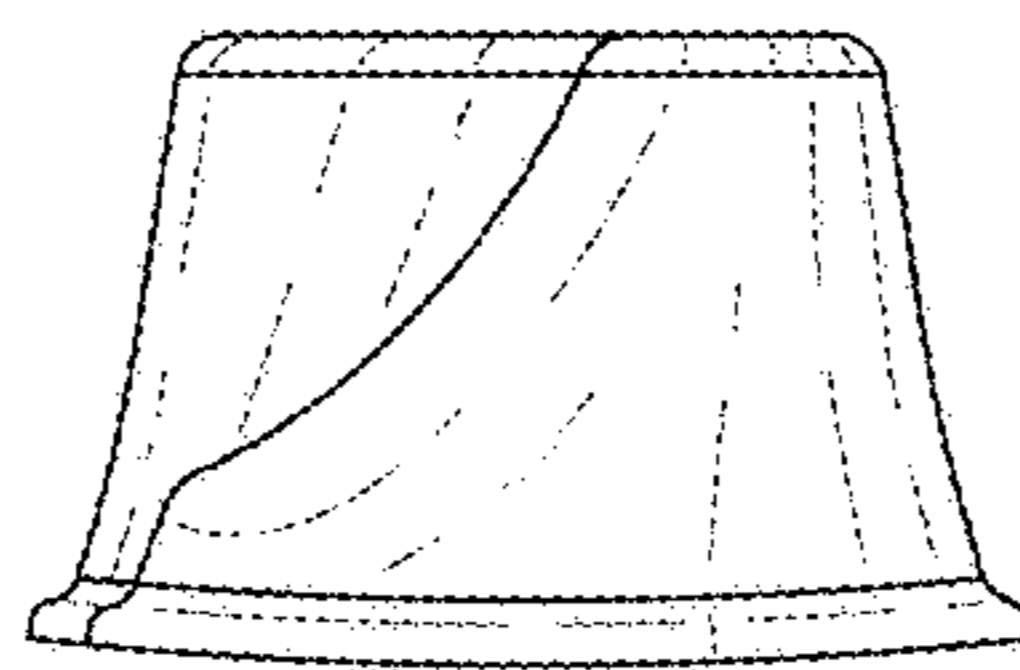

FIG. 6

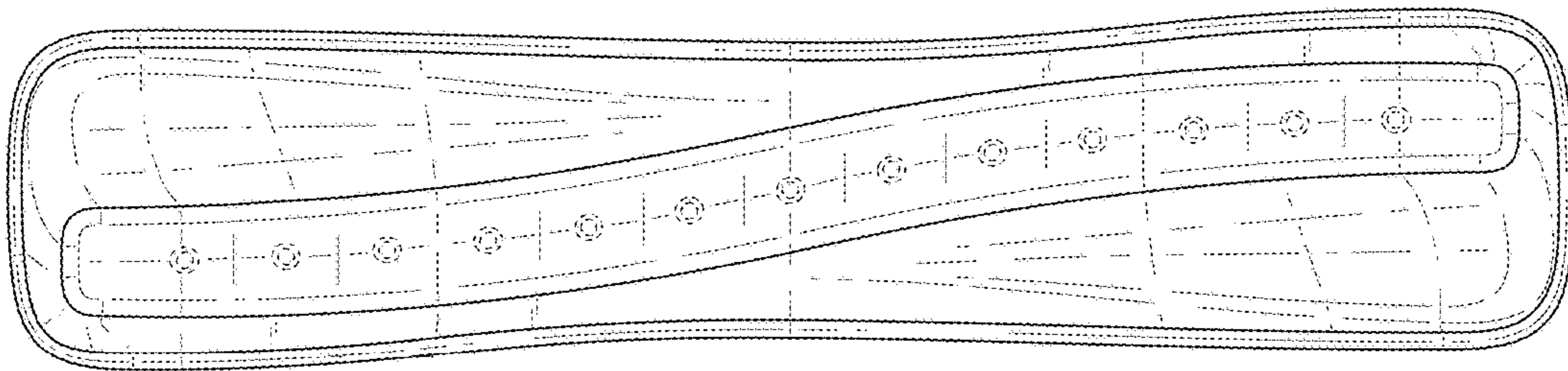

FIG. 7

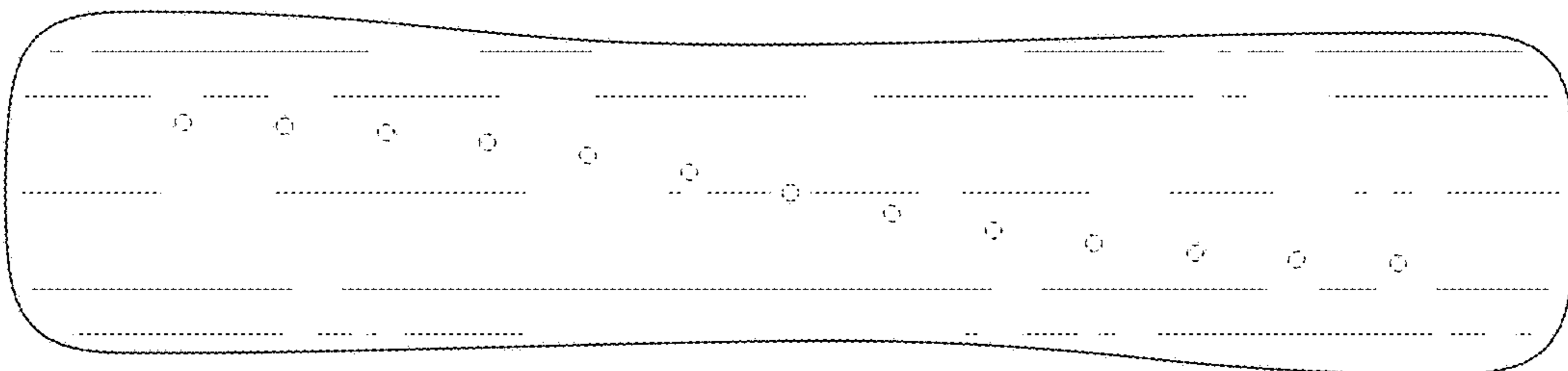

FIG. 8

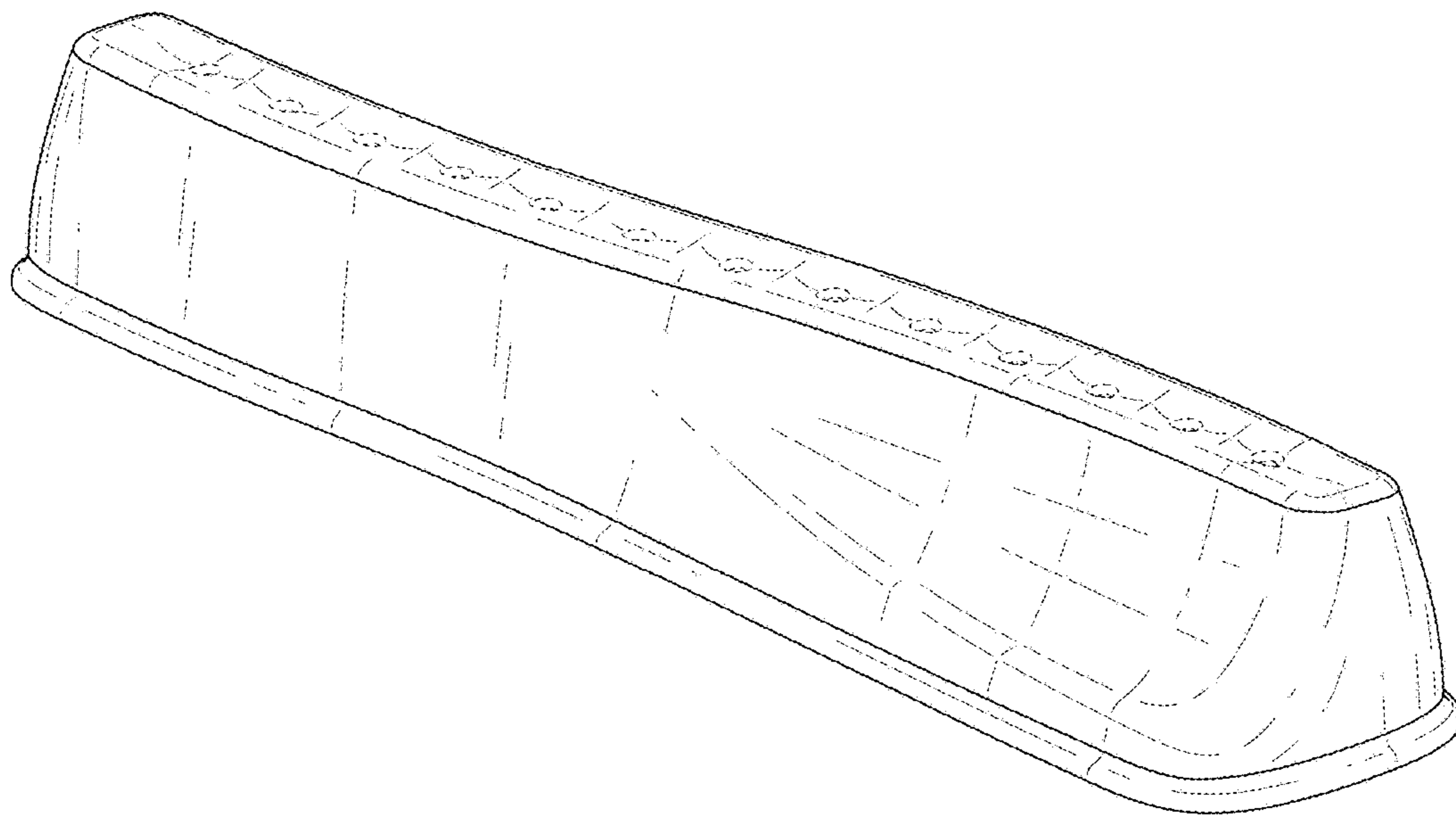
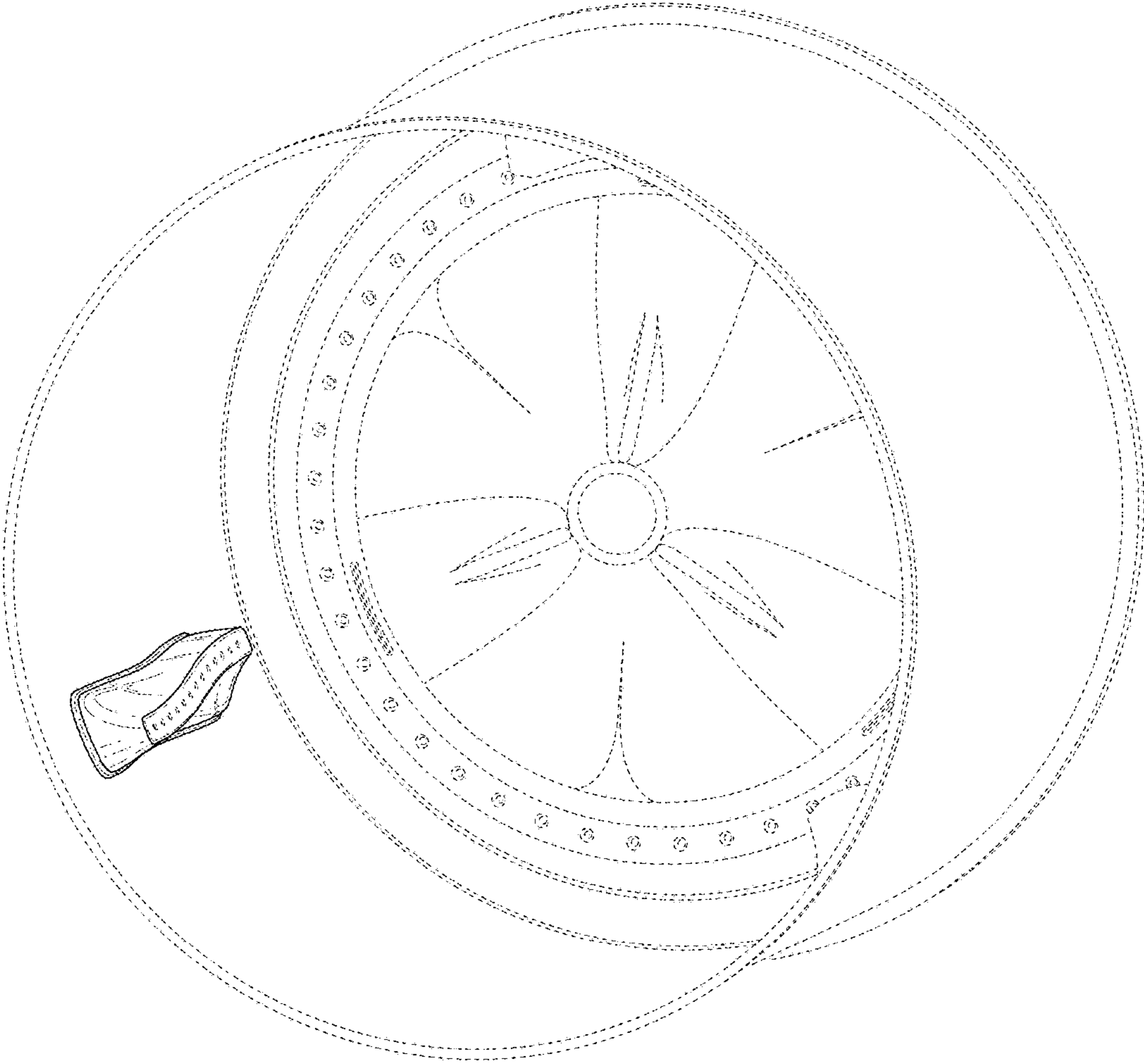

FIG. 9



UNITED STATES PATENT AND TRADEMARK OFFICE
CERTIFICATE OF CORRECTION

PATENT NO. : D854,766 S
APPLICATION NO. : 29/616937
DATED : July 23, 2019
INVENTOR(S) : Choi et al.

Page 1 of 1

It is certified that error appears in the above-identified patent and that said Letters Patent is hereby corrected as shown below:

On the Title Page

At Item (54), Delete the title and insert --PADDLE LIFTER FOR WASHING MACHINE--

Signed and Sealed this
Third Day of September, 2019

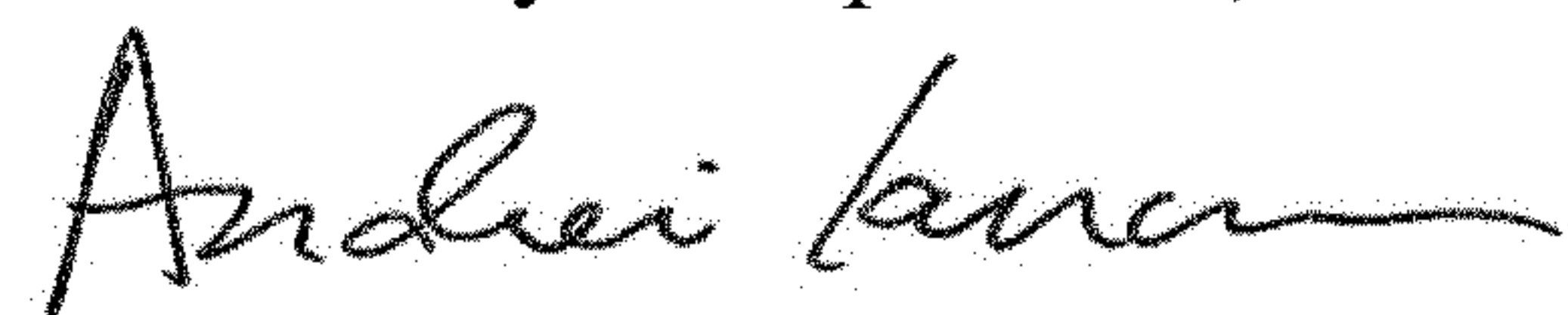

Andrei Iancu
Director of the United States Patent and Trademark Office