



US00D854744S

(12) **United States Design Patent**
Tanaka

(10) **Patent No.:** **US D854,744 S**
(45) **Date of Patent:** **** Jul. 23, 2019**

(54) **COSMETIC APPLICATOR**

DESCRIPTION

- (71) Applicant: **SINWA CORPORATION**, Kanagawa (JP)
- (72) Inventor: **Akihiro Tanaka**, Kanagawa (JP)
- (73) Assignee: **SINWA CORPORATION**, Kanagawa (JP)

(**) Term: **15 Years**

(21) Appl. No.: **29/624,583**

(22) Filed: **Nov. 2, 2017**

(30) **Foreign Application Priority Data**

May 15, 2017 (JP) 2017-010246
 May 23, 2017 (JP) 2017-010929

(51) **LOC (11) Cl.** **D28-02**

(52) **U.S. Cl.**
USPC **D28/7**

(58) **Field of Classification Search**
USPC D28/7, 8, 30, 31, 43, 76, 85, 99;
D4/132-135, 137; D7/361, 393, 395,
D7/685; D9/723, 724; D24/119
(Continued)

(56) **References Cited**

U.S. PATENT DOCUMENTS

D307,063 S * 4/1990 Lin D28/7
 D408,592 S * 4/1999 Litton D19/163
 (Continued)

Primary Examiner — Susan Bennett Hattan

Assistant Examiner — Rebecca Tsehay

(74) *Attorney, Agent, or Firm* — Roberts Mlotkowski
Safran Cole & Calderon P.C.

(57) **CLAIM**

The ornamental design for a cosmetic applicator, as shown and described.

FIG. 1 is a perspective view of a first embodiment of the cosmetic applicator;
 FIG. 2 is a side view of the cosmetic applicator shown in FIG. 1;
 FIG. 3 is an opposite side view of the cosmetic applicator shown in FIG. 1;
 FIG. 4 is a top end view of the cosmetic applicator shown in FIG. 1;
 FIG. 5 is a bottom end view of the cosmetic applicator shown in FIG. 1;
 FIG. 6 is a plan side view of the cosmetic applicator shown in FIG. 1;
 FIG. 7 is a bottom side view of the cosmetic applicator shown in FIG. 1;
 FIG. 8 is a perspective, exploded view of the first embodiment of the cosmetic applicator;
 FIG. 9 is a perspective view of a second embodiment of the cosmetic applicator;
 FIG. 10 is a side view of the cosmetic applicator shown in FIG. 9;
 FIG. 11 is an opposite side view of the cosmetic applicator shown in FIG. 9;
 FIG. 12 is a top end view of the cosmetic applicator shown in FIG. 9;
 FIG. 13 is a bottom end view of the cosmetic applicator shown in FIG. 9;
 FIG. 14 is a plan side view of the cosmetic applicator shown in FIG. 9;
 FIG. 15 is a bottom side view of the cosmetic applicator shown in FIG. 9; and,
 FIG. 16 is a perspective, exploded view of the second embodiment of the cosmetic applicator.
 The present article is a cosmetic applicator used for applying cosmetics such as eye shadow. In the first embodiment, the lower end of the container body is opaque while in the second embodiment the lower end of the container body is transparent.
 The broken lines in the drawings depict portions of the cosmetic applicator that form no part of the claimed design.

1 Claim, 6 Drawing Sheets

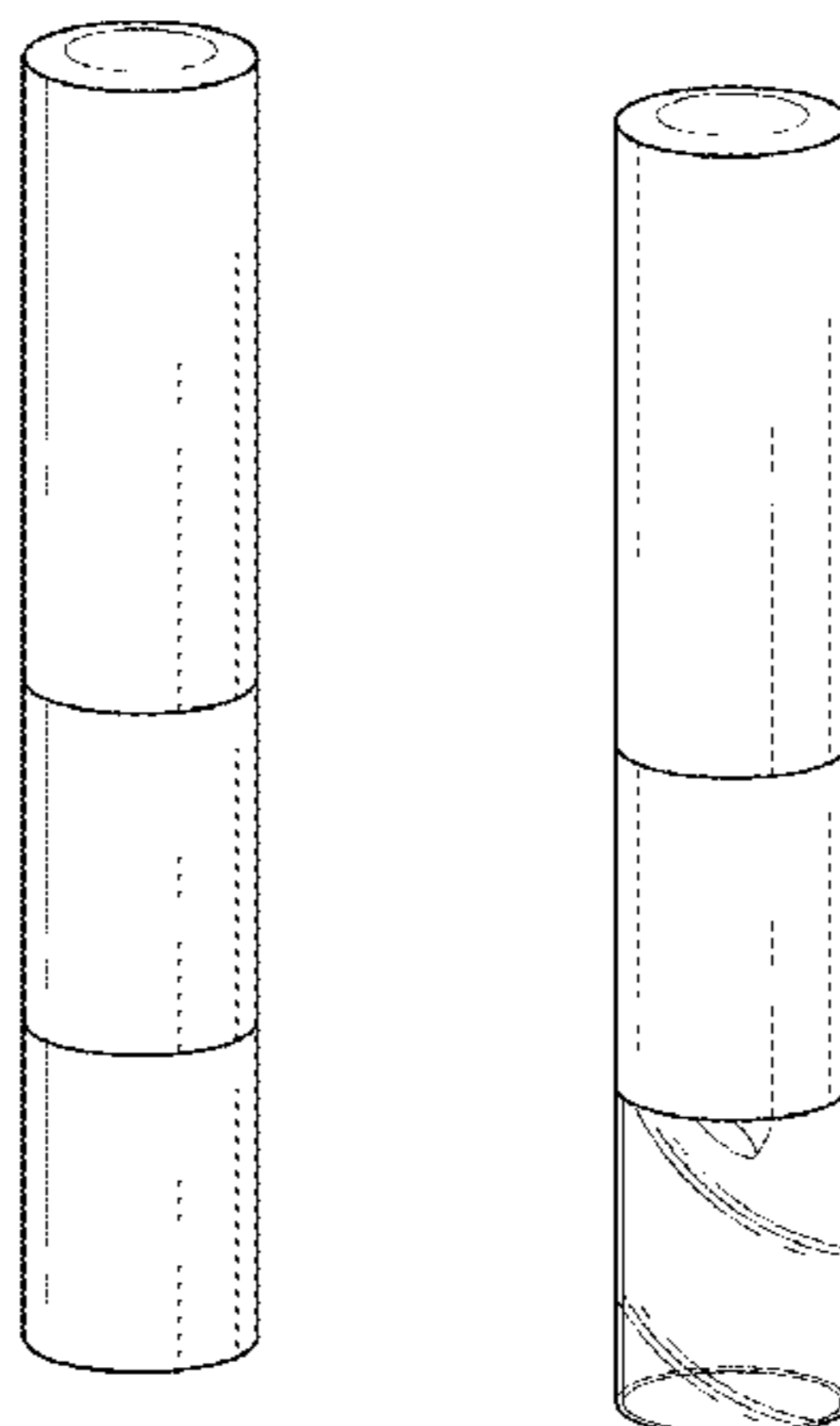

(58) **Field of Classification Search**

CPC A45D 2200/10; A45D 2200/1009; A45D
2200/1036; A45D 40/262; A45D
2040/0006; A45D 40/30; A61M 35/00;
A61M 35/003; B65D 43/163; B65D
85/54

See application file for complete search history.

(56) **References Cited**

U.S. PATENT DOCUMENTS

| | | | | | | |
|----------|---|---|---------|-------------|-------|---------|
| D436,225 | S | * | 1/2001 | Garofano | | D28/7 |
| D508,297 | S | * | 8/2005 | Breidenbach | | D28/88 |
| D693,059 | S | * | 11/2013 | Tani | | D28/7 |
| D703,052 | S | * | 4/2014 | Park | | D9/503 |
| D703,053 | S | * | 4/2014 | Park | | D9/503 |
| D709,379 | S | * | 7/2014 | Moretti | | D9/529 |
| D741,004 | S | * | 10/2015 | Kloman | | D28/4 |
| D747,827 | S | * | 1/2016 | Taha | | D27/163 |
| D748,865 | S | * | 2/2016 | Hall | | D28/85 |
| D806,314 | S | * | 12/2017 | Hamida | | D28/7 |
| D808,822 | S | * | 1/2018 | Villarreal | | D9/724 |
| D816,897 | S | * | 5/2018 | Corsi | | D28/7 |

* cited by examiner

FIG. 1

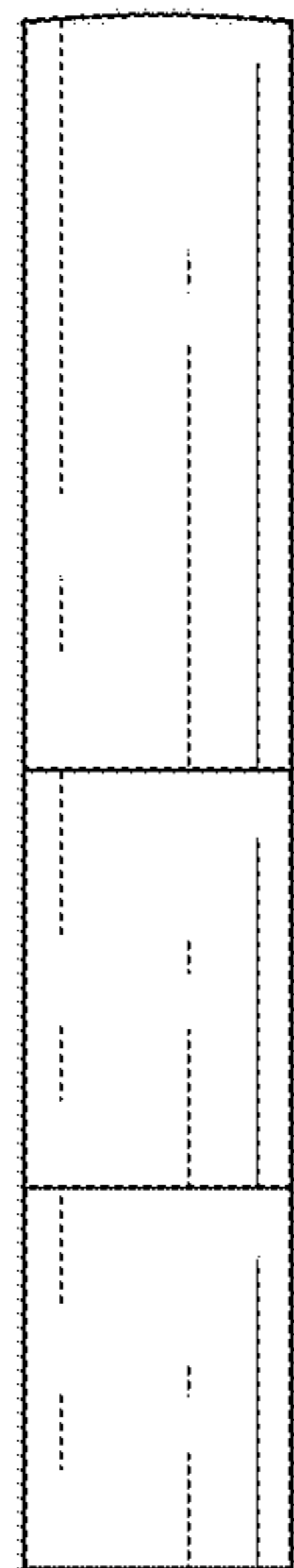

FIG. 2

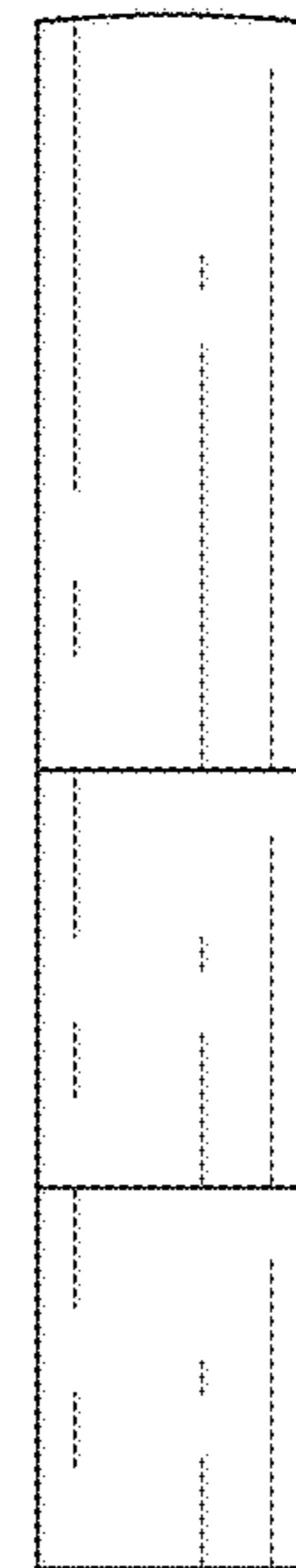

FIG. 3



FIG. 4

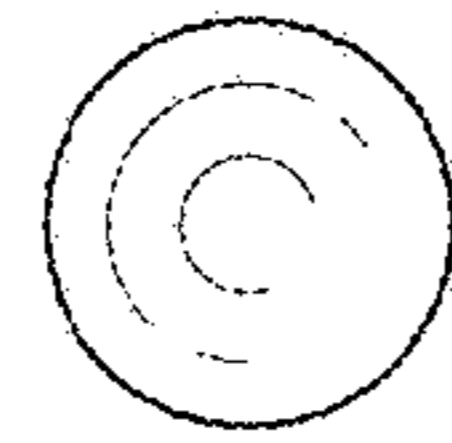

FIG. 5

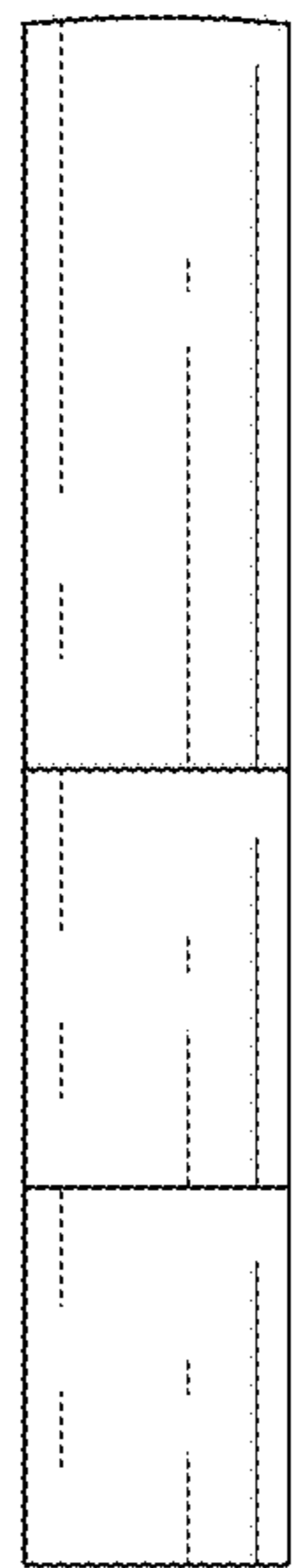

FIG. 6

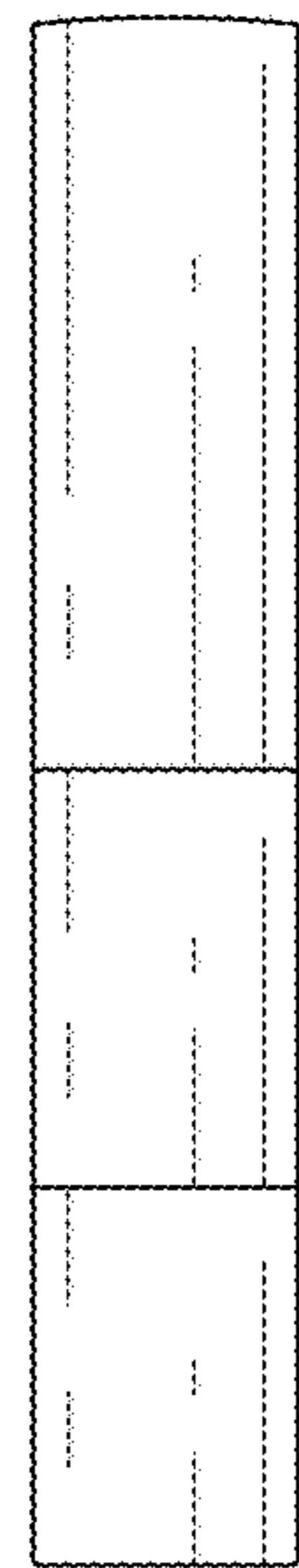

FIG. 7

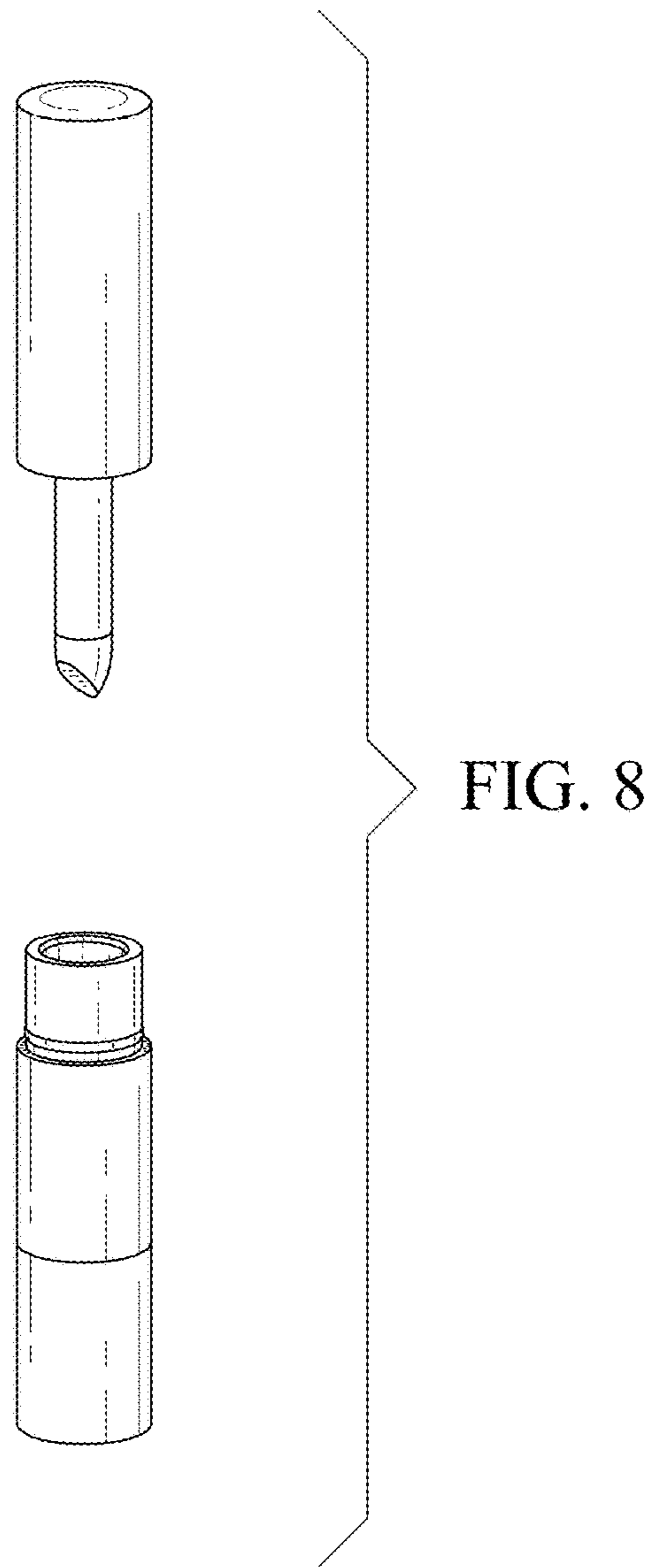

FIG. 9

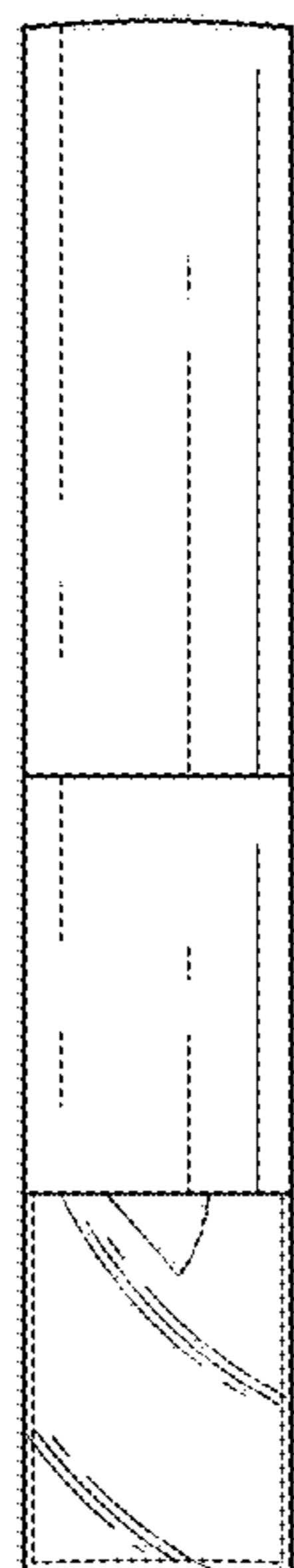
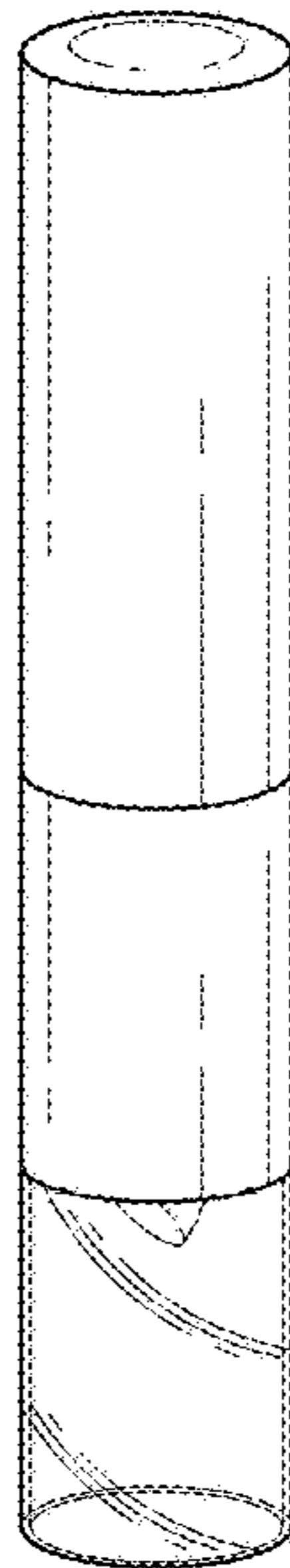

FIG. 10



FIG. 11

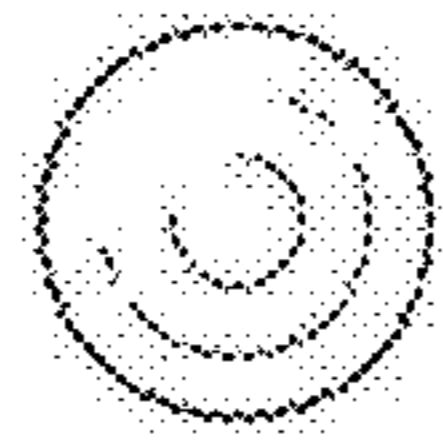

FIG. 12

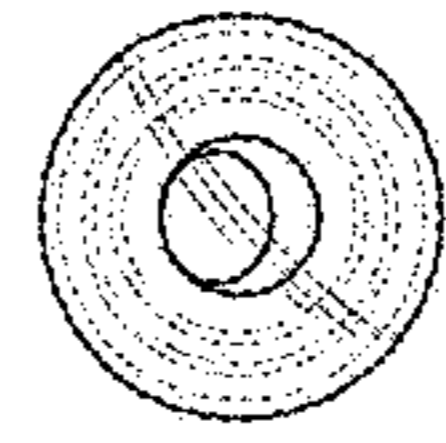

FIG. 13

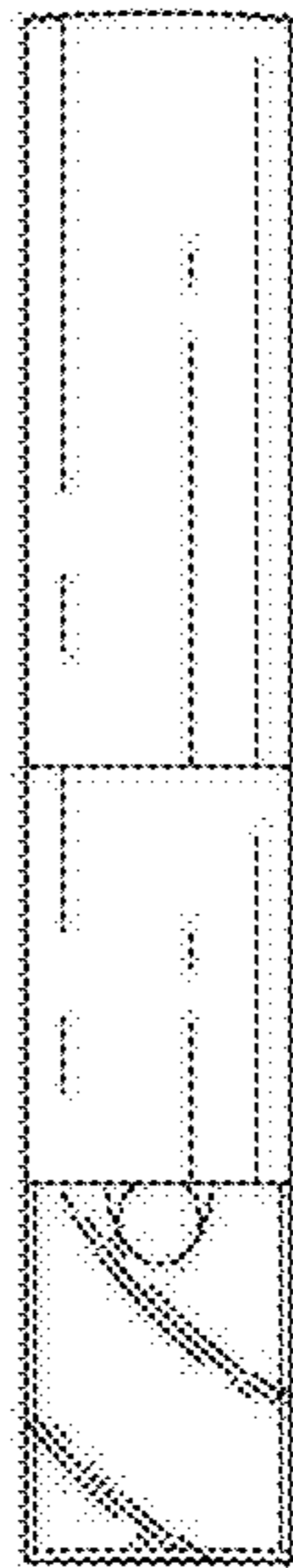

FIG. 14

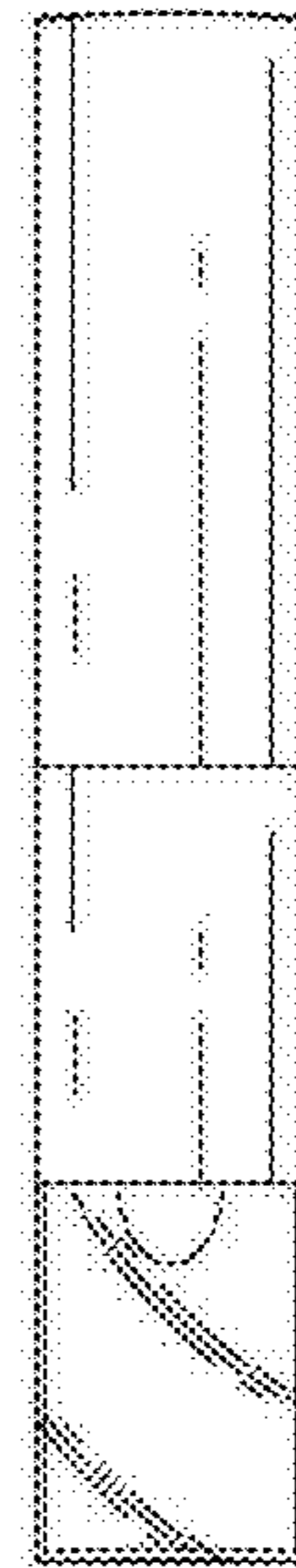

FIG. 15

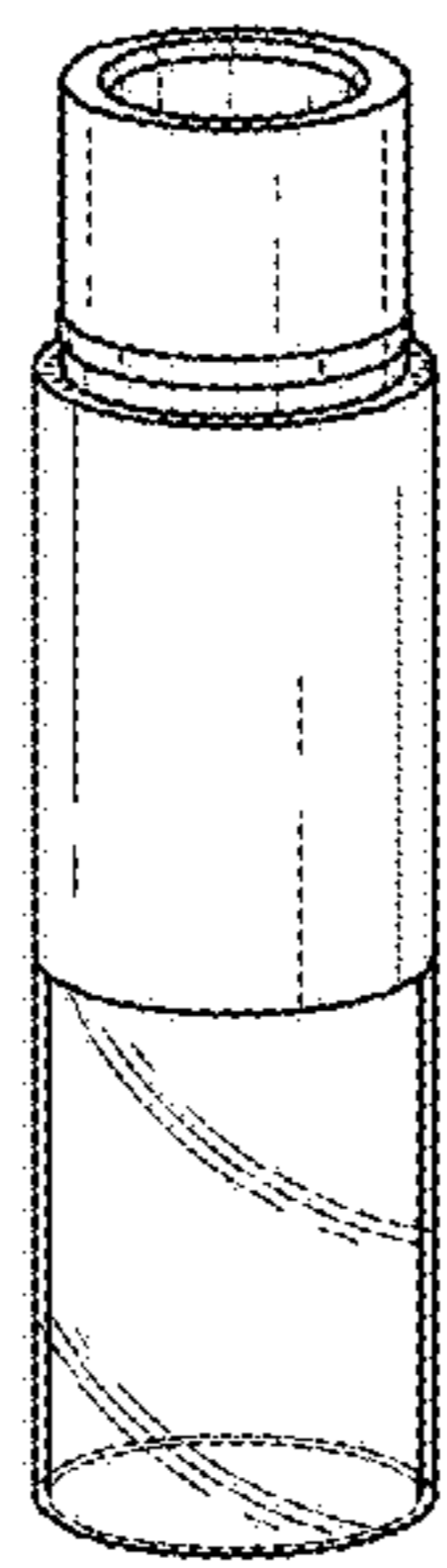
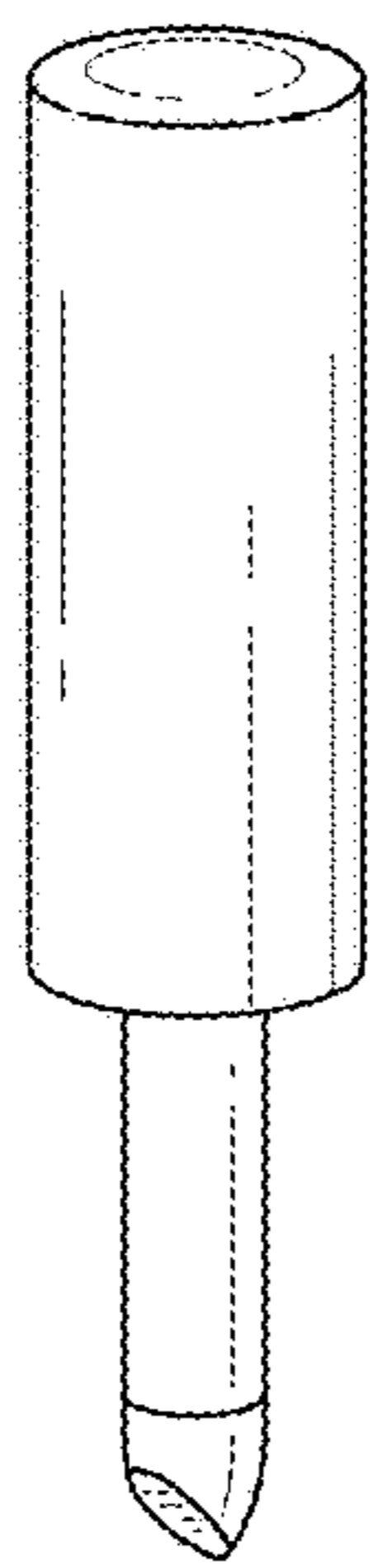

FIG. 16