



US00D854622S

(12) **United States Design Patent** (10) **Patent No.:** **US D854,622 S**
Fissell et al. (45) **Date of Patent:** **** Jul. 23, 2019**

(54) **GAMING TABLE**

(71) Applicant: **FISSELL BROS, INC.**, San Luis Obispo, CA (US)
(72) Inventors: **Jeremy Fissell**, San Luis Obispo, CA (US); **Nathan Fissell**, North Hollywood, CA (US)

(**) Term: **15 Years**
(21) Appl. No.: **29/614,822**
(22) Filed: **Aug. 23, 2017**

Related U.S. Application Data

(63) Continuation of application No. 29/582,009, filed on Oct. 24, 2016, now abandoned.
(51) **LOC (11) Cl.** **21-01**
(52) **U.S. Cl.**
USPC **D21/397**
(58) **Field of Classification Search**
USPC D21/397, 317
CPC A47B 3/0915; A47B 3/00; A47B 3/083
See application file for complete search history.

(56) **References Cited**

U.S. PATENT DOCUMENTS

2,633,395 A	3/1953	Zenner
2,871,076 A	1/1959	Mell
D248,914 S	8/1978	Ettress
4,491,954 A	1/1985	Genuit
D340,301 S	10/1993	Evans et al.
5,305,998 A	4/1994	Nesbit et al.
5,542,017 A	7/1996	Koike
5,941,778 A	8/1999	Vasalech
D441,479 S	5/2001	McCormick et al.
D468,566 S	1/2003	Morris
D492,427 S	6/2004	Egawa et al.
D492,428 S	6/2004	Egawa et al.
6,752,091 B2	6/2004	Glover et al.
D509,606 S	9/2005	Egawa

(Continued)

OTHER PUBLICATIONS

“New 8’ Beer Pong Table Aluminum Portable Adjustable Folding Indoor Outdoor Tailgate Party Game #8” by Pongbuddy, <http://www.amazon.com/aluminum-portable-adjustable-folding-tailgate/kp/B00MQCZG18> depicting Beer Pong Table, 5 pgs. Accessed May 22, 2015.

(Continued)

Primary Examiner — George D. Kirschbaum

(57) **CLAIM**

An ornamental design for a gaming table, as shown and described.

DESCRIPTION

FIG. 1 is a perspective view of a first embodiment of our new design of a gaming table;
FIG. 2 is a top view thereof;
FIG. 3 is a bottom view thereof;
FIG. 4 is front view thereof;
FIG. 5 is a review view thereof;
FIG. 6 is a right side view thereof;
FIG. 7 is a left side view thereof;
FIG. 8 is an enlarged partial cross-sectional view taken from FIG. 1;
FIG. 9 a perspective view of a second embodiment of our design of a gaming table;
FIG. 10 is a top view thereof;
FIG. 11 is a bottom view thereof;
FIG. 12 is a front view thereof;
FIG. 13 is a rear view thereof;
FIG. 14 is a right side view thereof;
FIG. 15 is a left side view thereof; and,
FIG. 16 is an enlarged partial cross-sectional view taken from FIG. 9.
The broken lines depicting portions of the table are understood to be unclaimed environmental subject matter.

1 Claim, 14 Drawing Sheets

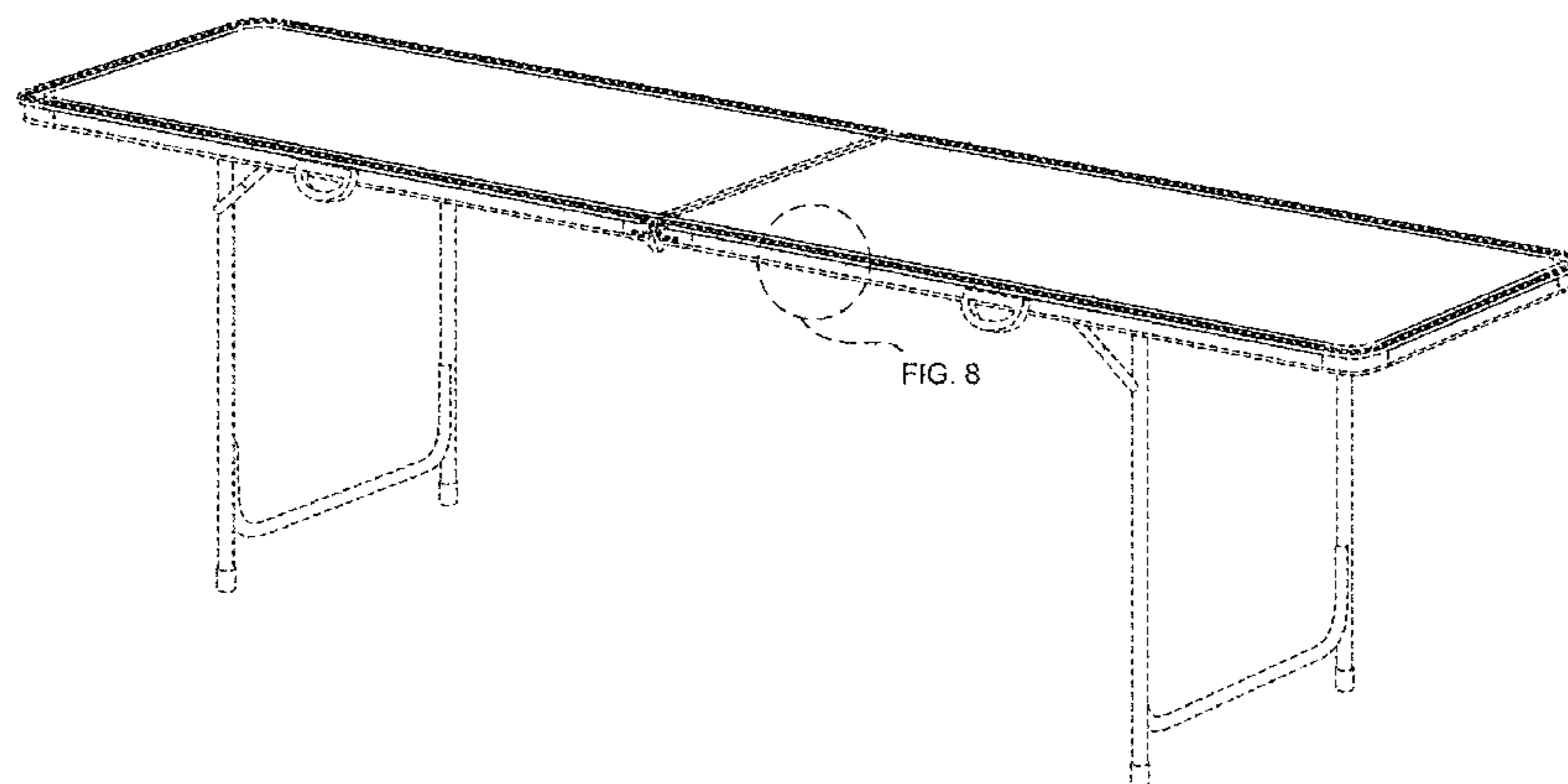

(56)

References Cited

U.S. PATENT DOCUMENTS

7,156,396	B1	1/2007	Voden	
D538,355	S *	3/2007	Tyson	D21/317
7,325,807	B1	2/2008	Eason	
7,451,709	B2	11/2008	Swartfager et al.	
D605,787	S	12/2009	Barton et al.	
7,893,953	B2	2/2011	Krestakos et al.	
D654,204	S	2/2012	Friesen	
8,127,689	B2	3/2012	Christian et al.	
8,156,875	B2 *	4/2012	Neunzert	A47B 3/083 108/129
8,166,894	B1	5/2012	Branch et al.	
8,167,732	B2	5/2012	Tsai	
D662,236	S	6/2012	Matsushita	
8,205,887	B2	6/2012	Wyland	
D663,364	S	7/2012	Allmandinger	
8,235,389	B1	8/2012	Herro et al.	
D679,439	S	4/2013	Lai	
D715,869	S	10/2014	Dapo	
8,905,406	B2	12/2014	Brown	
8,925,926	B2	1/2015	Alway	
D723,627	S	3/2015	Shield	
D743,491	S	11/2015	Fissell et al.	
D754,797	S *	4/2016	Fissell	D21/397
D776,849	S	1/2017	Fissell	
D809,070	S *	1/2018	Fissell	D21/397
2003/0161151	A1	8/2003	Liu	
2004/0070149	A1	4/2004	Lipscomb et al.	
2005/0241551	A1 *	11/2005	Neunzert	A47B 3/00 108/132
2006/0226606	A1	10/2006	Finley et al.	
2006/0236905	A1 *	10/2006	Neunzert	A47B 3/0915 108/169
2008/0117648	A1	5/2008	Weiser	
2009/0194941	A1	8/2009	Boyd et al.	
2009/0322352	A1	12/2009	Zachut	
2014/0252718	A1	9/2014	Rieman	

OTHER PUBLICATIONS

BPONG® Beer Pong Table—Black—8-FT, Aluminum—by BPONG®, [http://www.bpong.com/store/aluminum-beer-pong-tables/bpong-beer-](http://www.bpong.com/store/aluminum-beer-pong-tables/bpong-beer-pong-table-black-8-ft-aluminum/)

pong-table-black-8-ft-aluminum/ depicting Beer Pong Table, 6 pgs. Accessed May 22, 2015.

Portable Super Mario Bros. Beer Pong Table—by that’snerdalicious!, <http://www.thatsnerdalicious.com/beer/bring-this-portable-super-mario-bros-beer-pong-table-to-your-next-party> depicting Beer Pong Table, 3 pgs. Posted Feb. 26, 2013.

Beer Pong Folding and Portable Beer Pong Table—by PartyPongTables.com, <http://www.wayfair.com/Party-Pong-Tables-Beer-Pong-Folding-and-Portable-Beer-Pong-Table-PP.BPT.BP.A-ERW1017.html> depicting Beer Pong Table, 3 pgs. Accessed May 22, 2015.

Best Choice Products® 8' Portable Beer Pong Table Foldable Outdoor Game Set—by Best Choice Products®, <http://www.amazon.com/Best-Choice-Products%C2%AE-Portable-Foldable/dp/B0055DRZ0U> depicting Beer Pong Table, 3 pgs. Accessed May 22, 2015.

Portable beer pong table—by corrie213 on instructables.com, <http://www.instructables.com/id/Portable-beer-pong-table> depicting Beer Pong Table, 4 pgs. Accessed May 22, 2015.

GoPong 8-Foot Portable Beer Pong / Tailgate Tables (Black, Football or American Flag)—by GoPong, <http://www.amazon.com/GoPong-Portable-Tailgate-Football-American/dp/B00DDPDNCQ> depicting Beer Pong Table, 2 pgs. Accessed May 22, 2015.

Design U.S. Appl. No. 29/429,066, ‘Table With Illuminating Perimeter’ (filed Aug. 7, 2012).

Design U.S. Appl. No. 29/528,833, ‘Gaming Table’ (filed Jun. 1, 2015).

Design U.S. Appl. No. 29/532,757, ‘Gaming Table’ (filed Jul. 9, 2015).

Notice of Allowance issued for Design U.S. Appl. No. 29/528,833, ‘Gaming Table’ (dated Jul. 1, 2015).

Notice of Allowance issued for Design U.S. Appl. No. 29/532,757, ‘Gaming Table’ (dated Dec. 30, 2015).

Notice of Allowance issued for Design U.S. Appl. No. 29/429,066, ‘Table With Illuminating Perimeter’ (dated Sep. 12, 2016).

Email with attachment from Nathan Fissell to Spencer Gifts (subject: ‘GlowPong 6.5’ Table sneak peek’) dated Mar. 18, 2014.

Email with attachment from Nathan Fissell to Spencer Gifts (subject: ‘GlowPong 6.5 Glowing Game Table NIS’) dated Mar. 18, 2014.

* cited by examiner

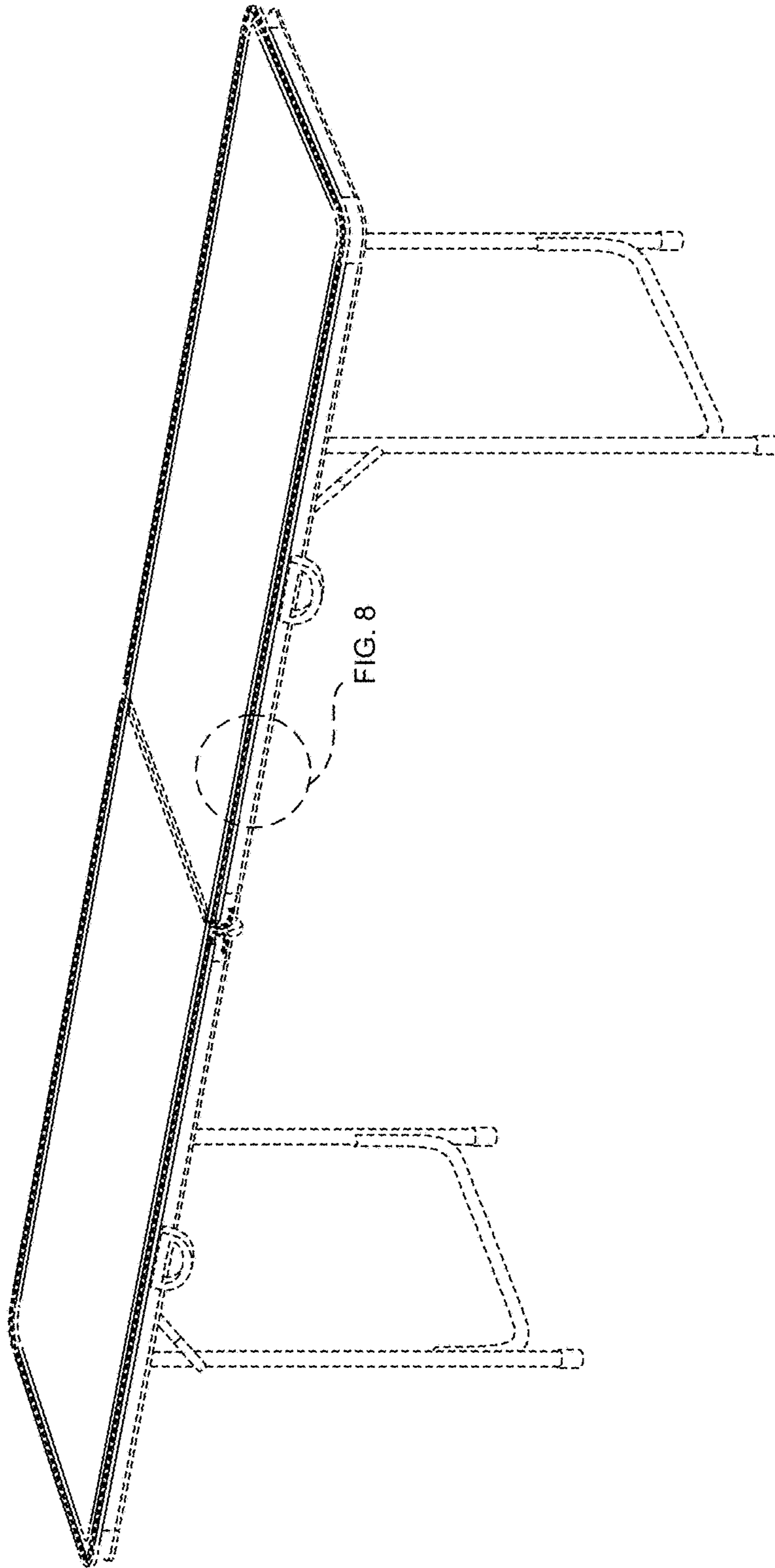

FIG. 1

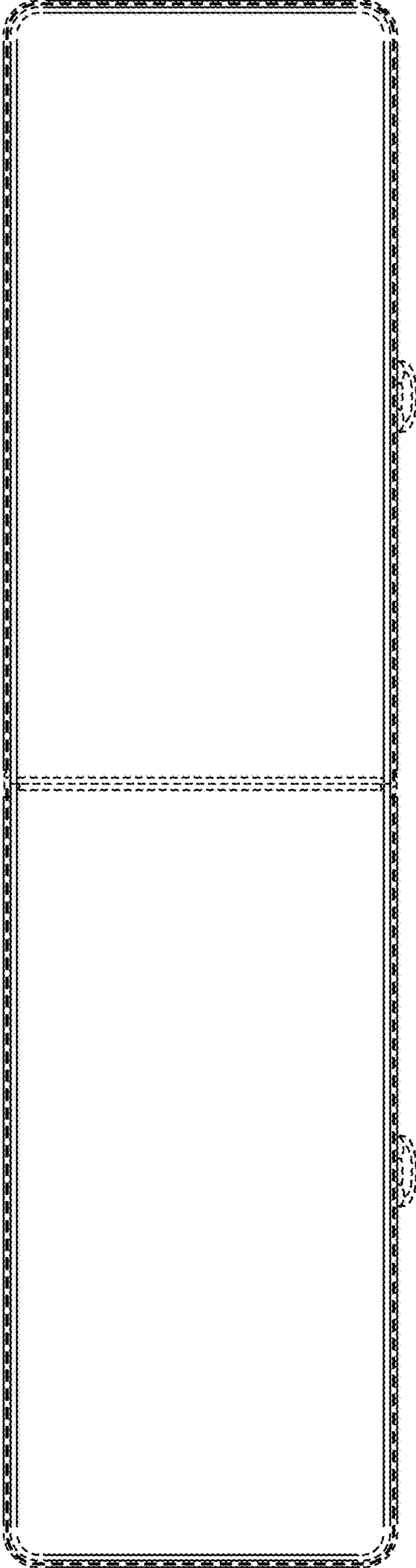

FIG. 2

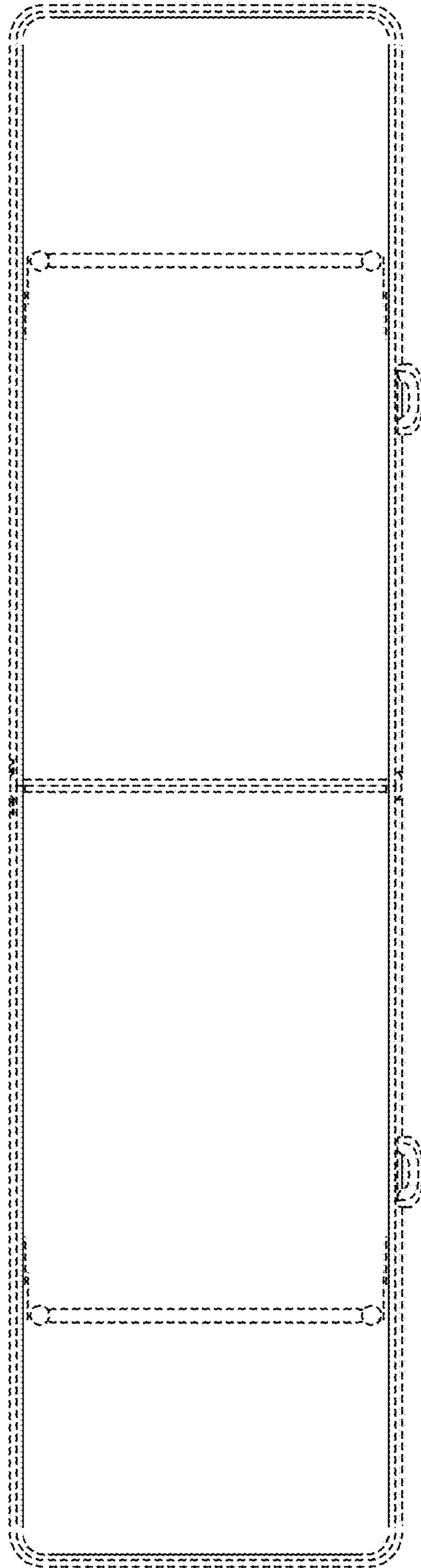

FIG. 3

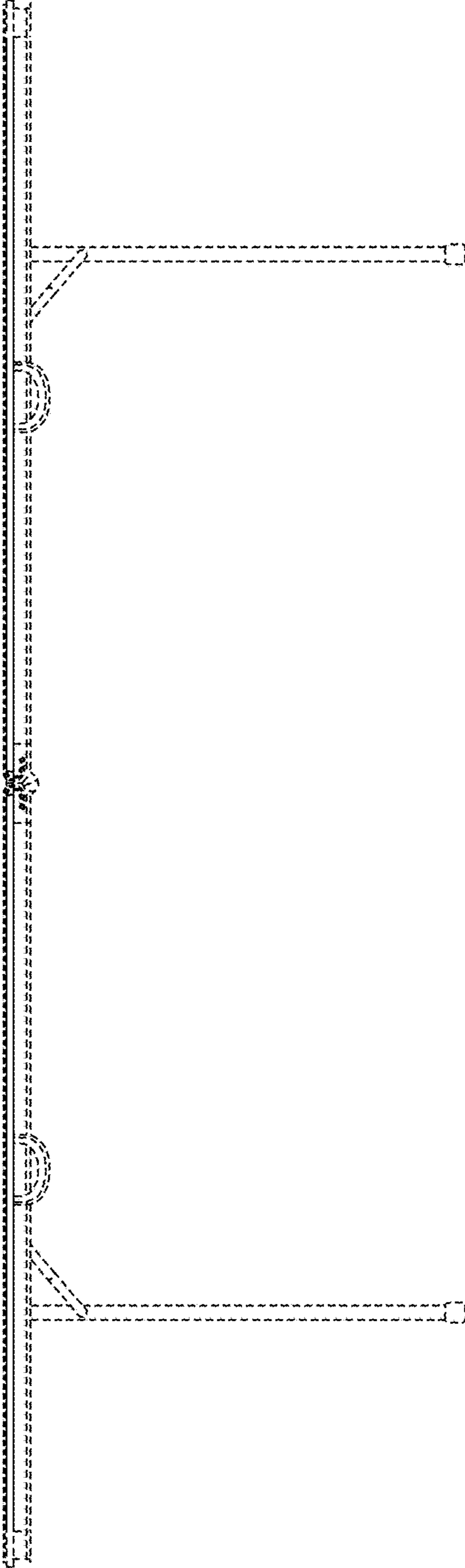

FIG. 4

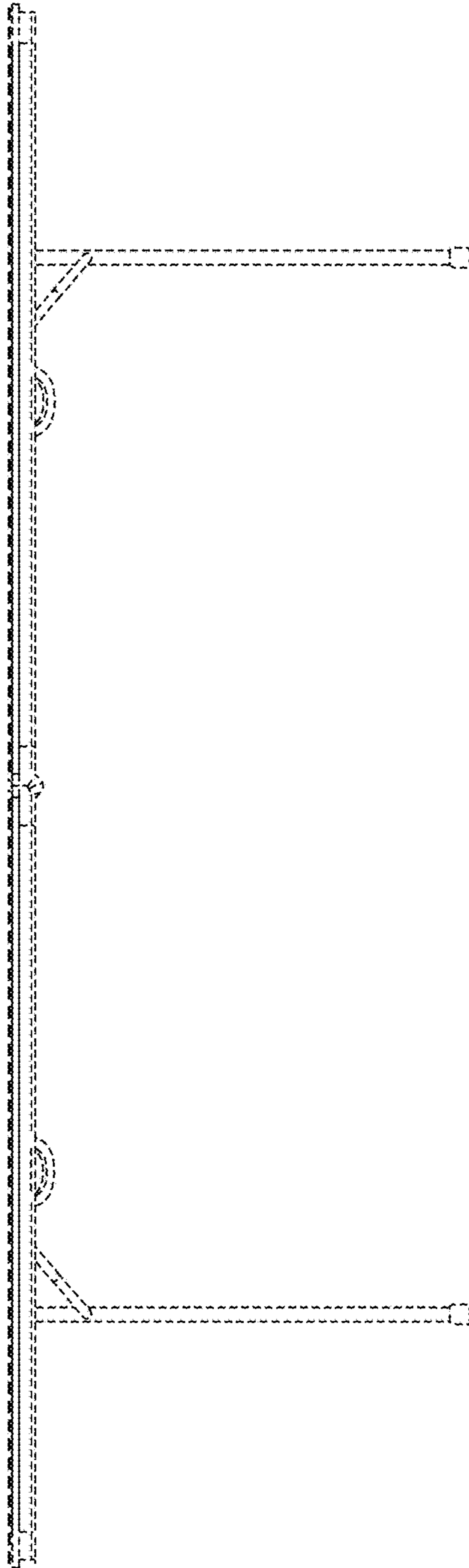

FIG. 5

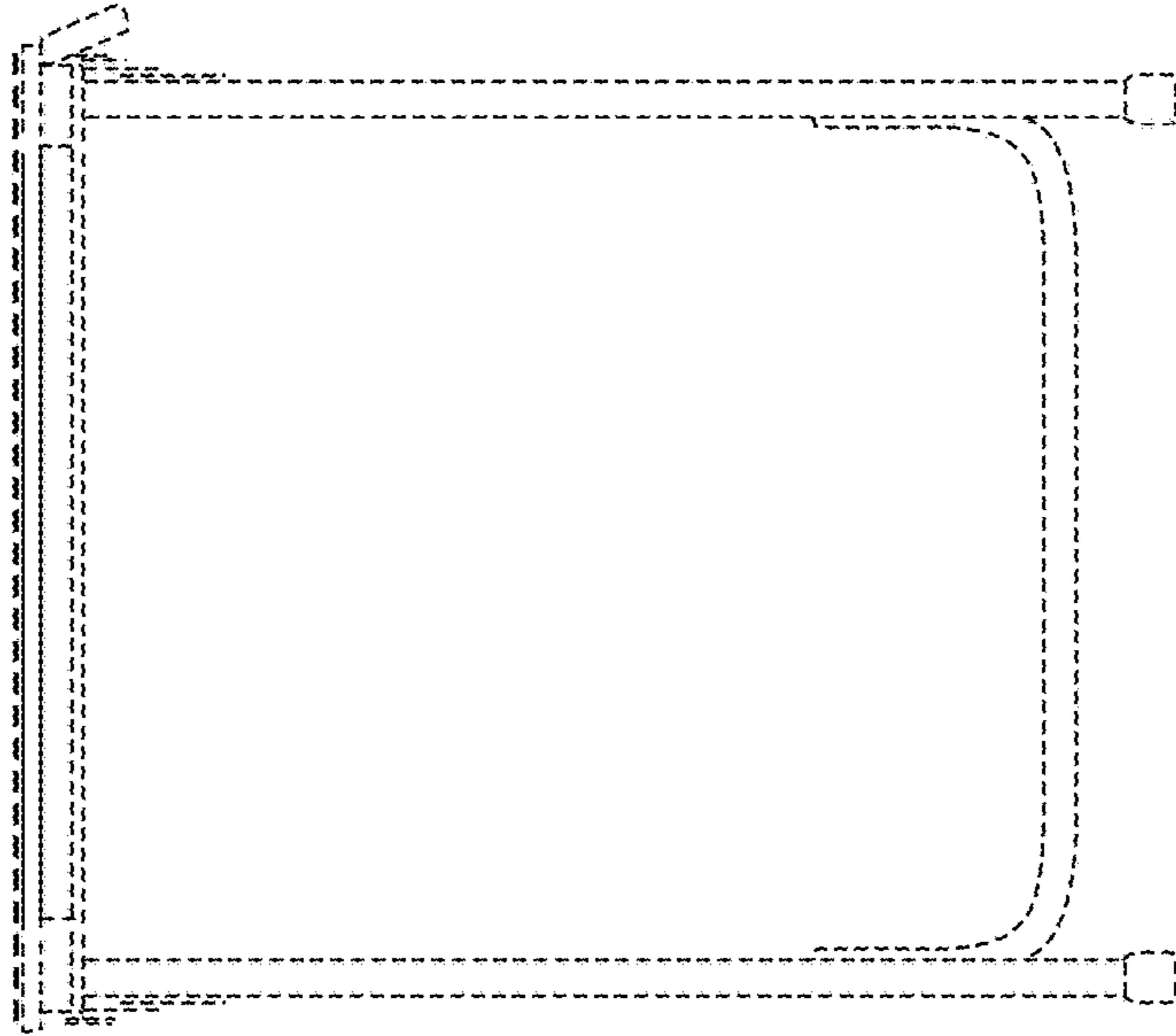

FIG. 7

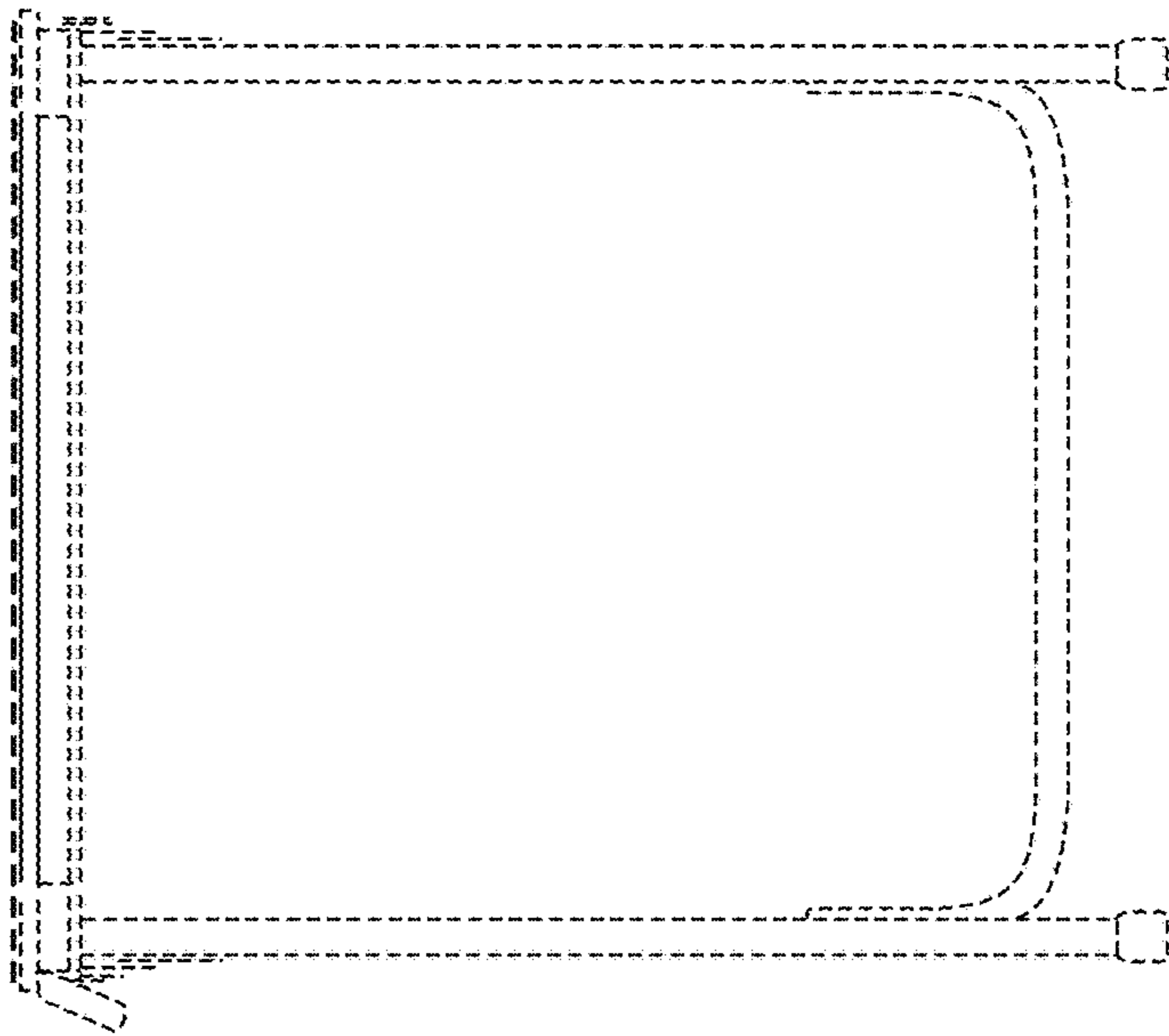

FIG. 6

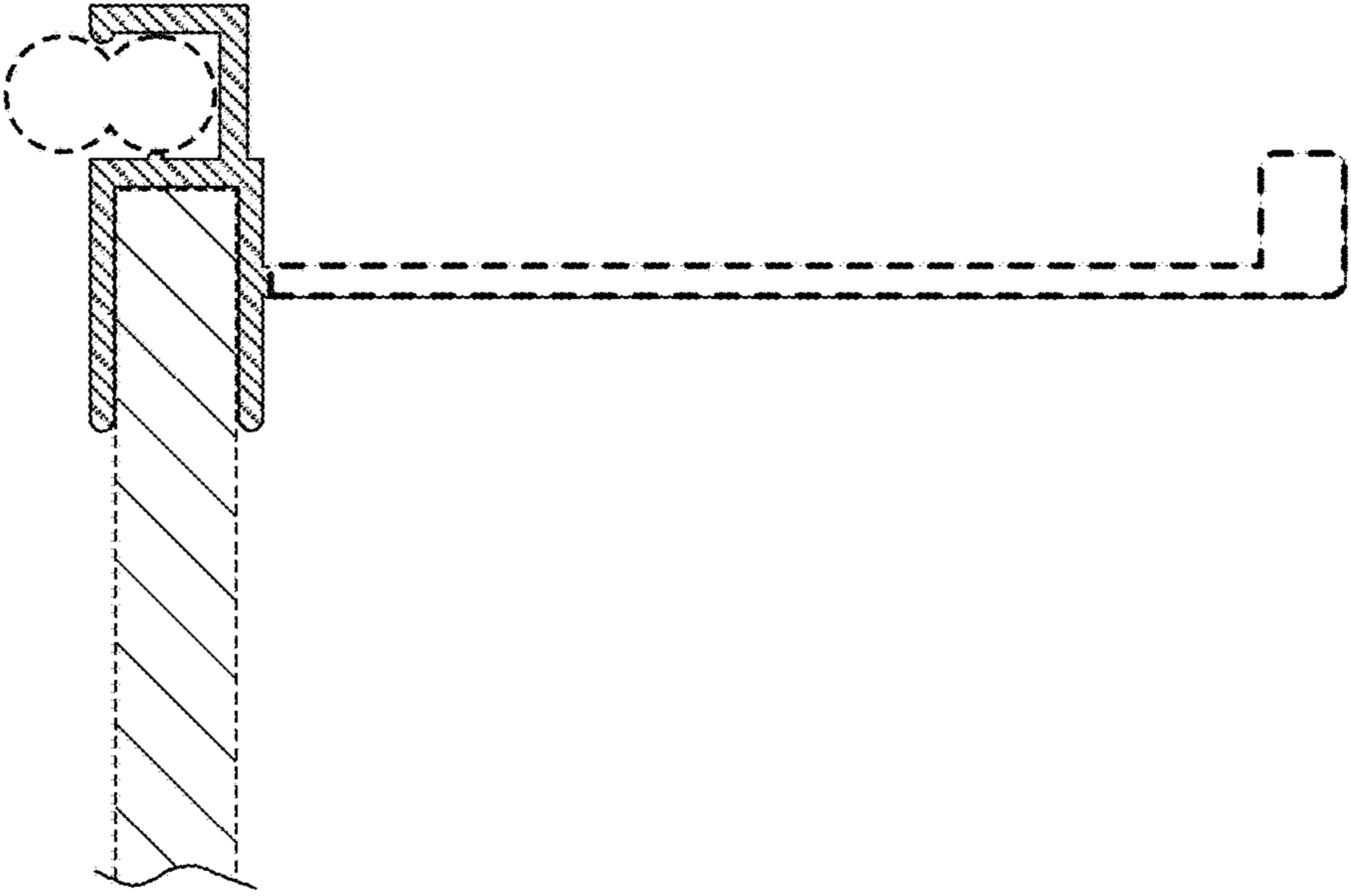

FIG. 8

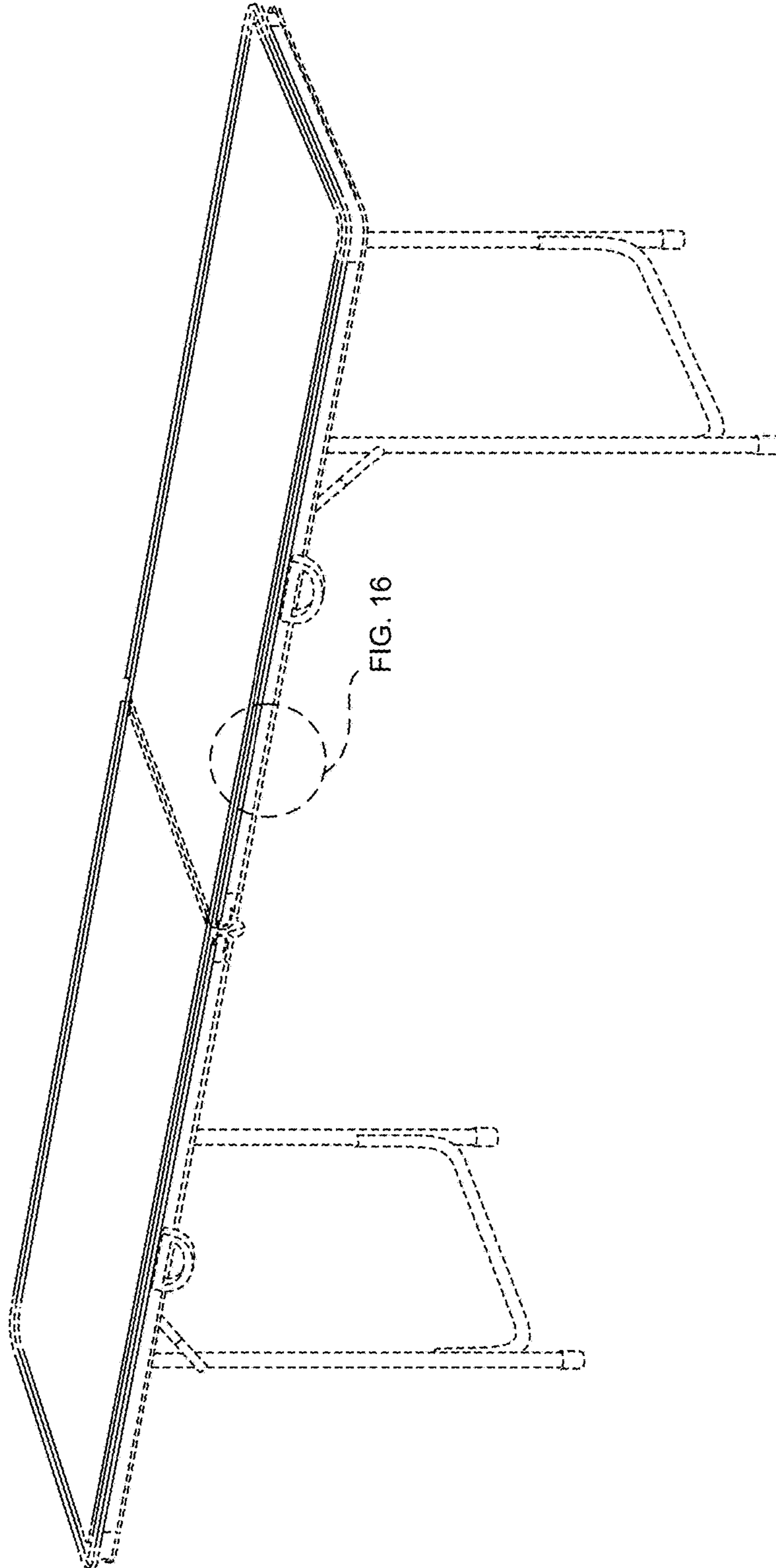

FIG. 9

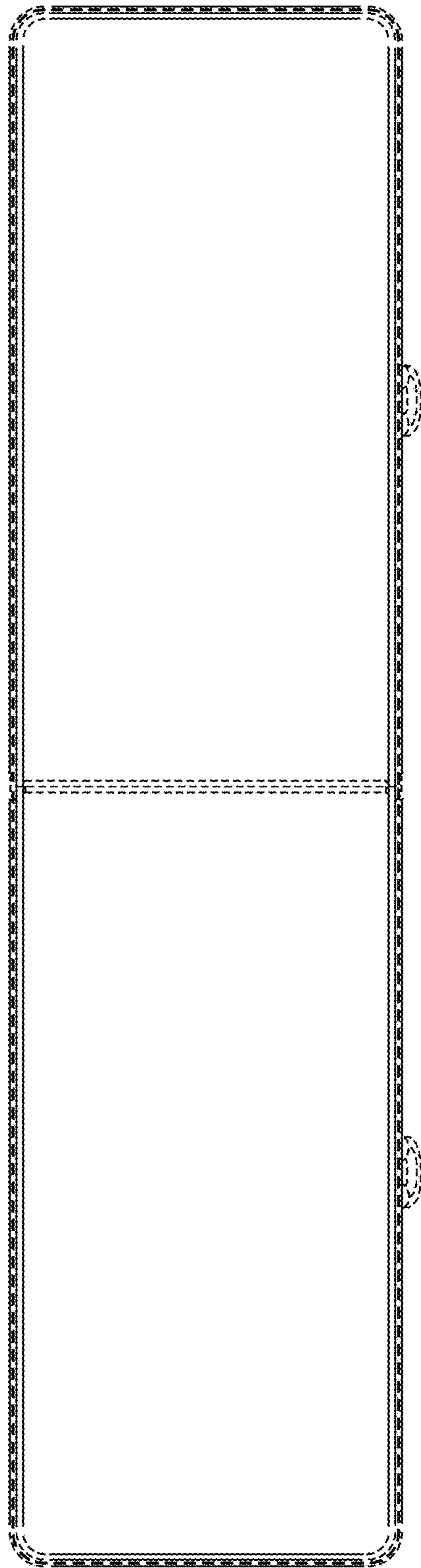

FIG. 10

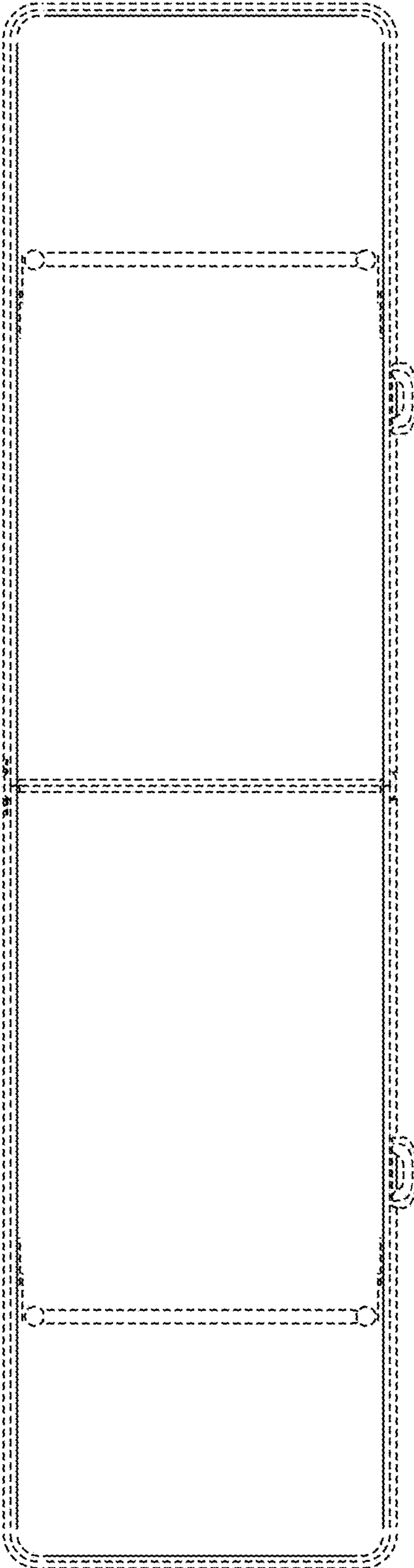

FIG. 11

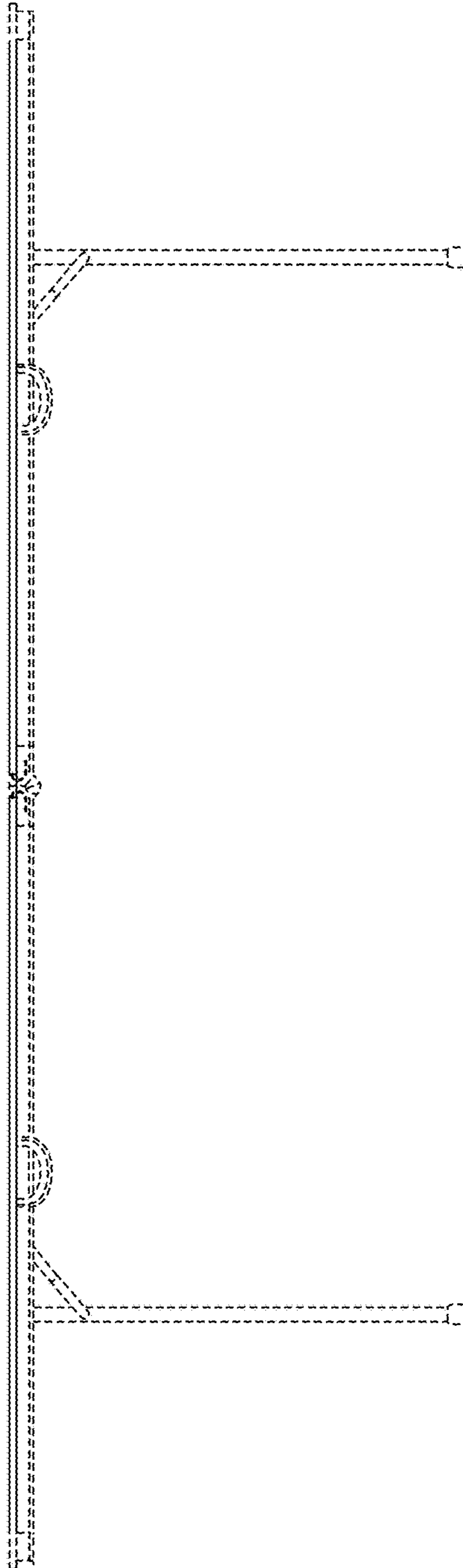

FIG. 12

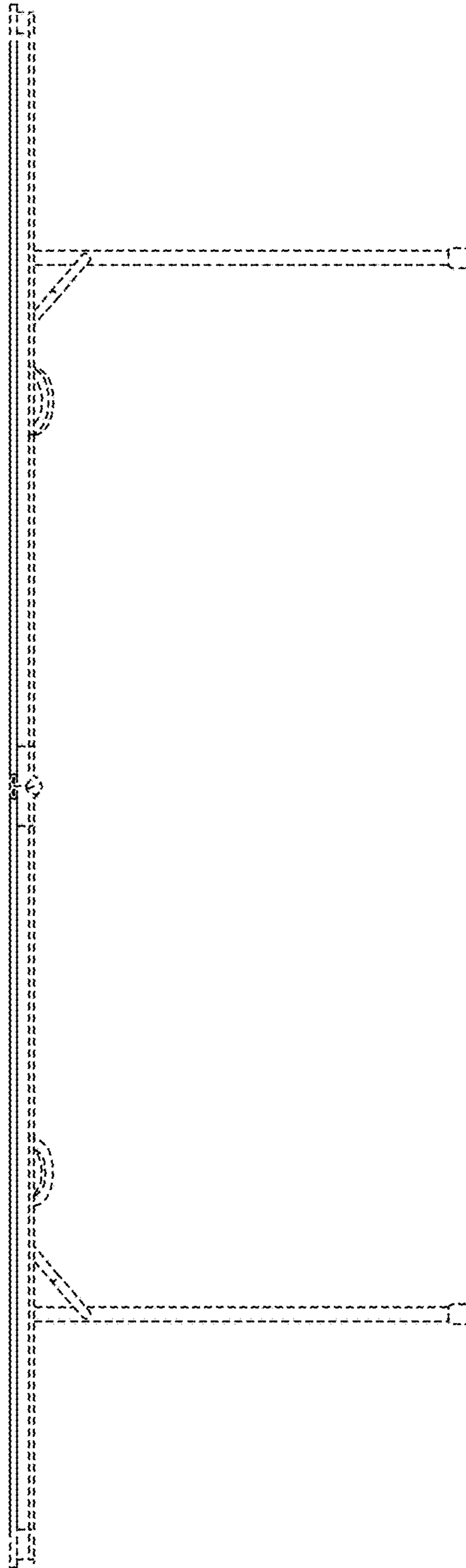

FIG. 13

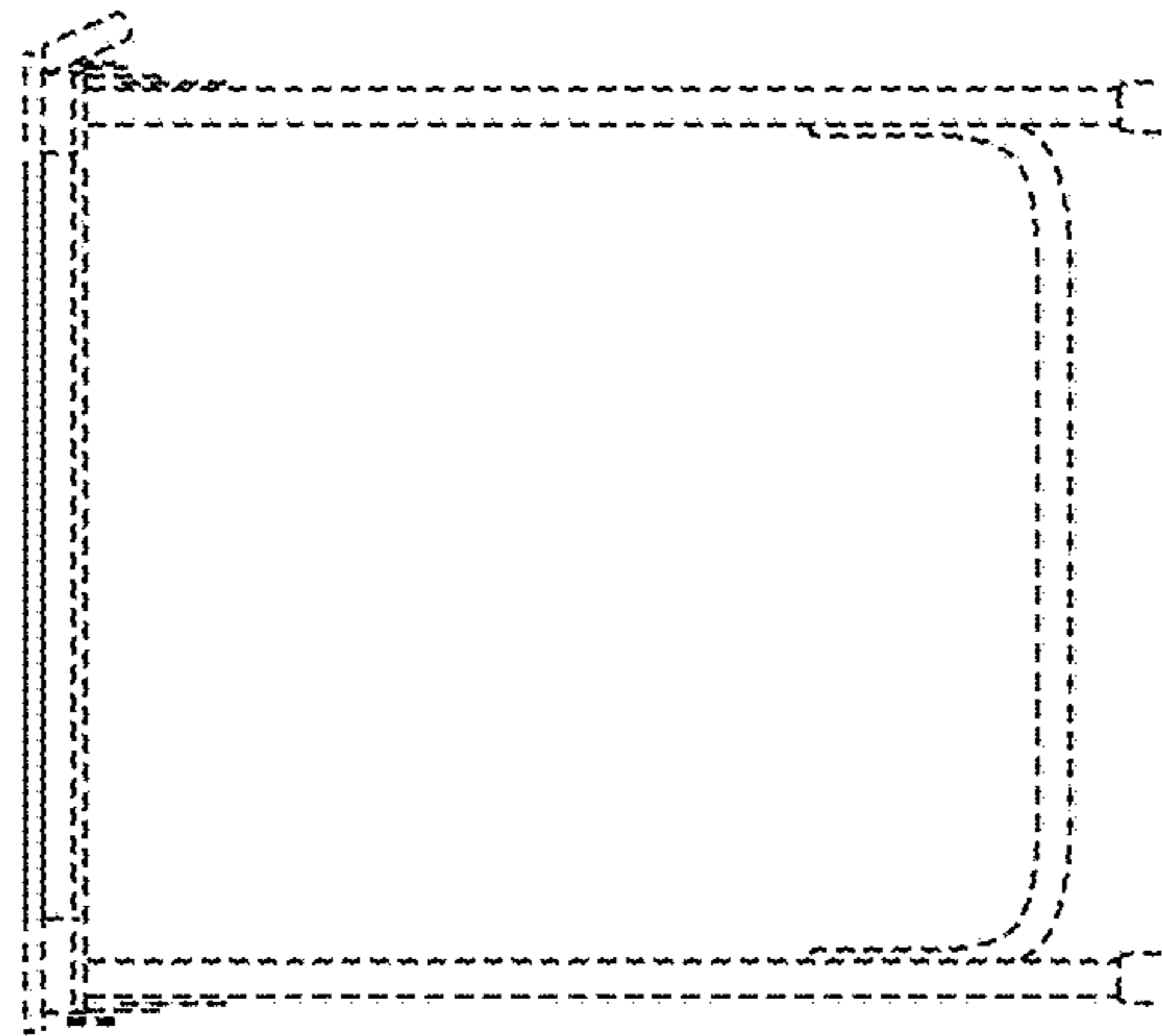

FIG. 15

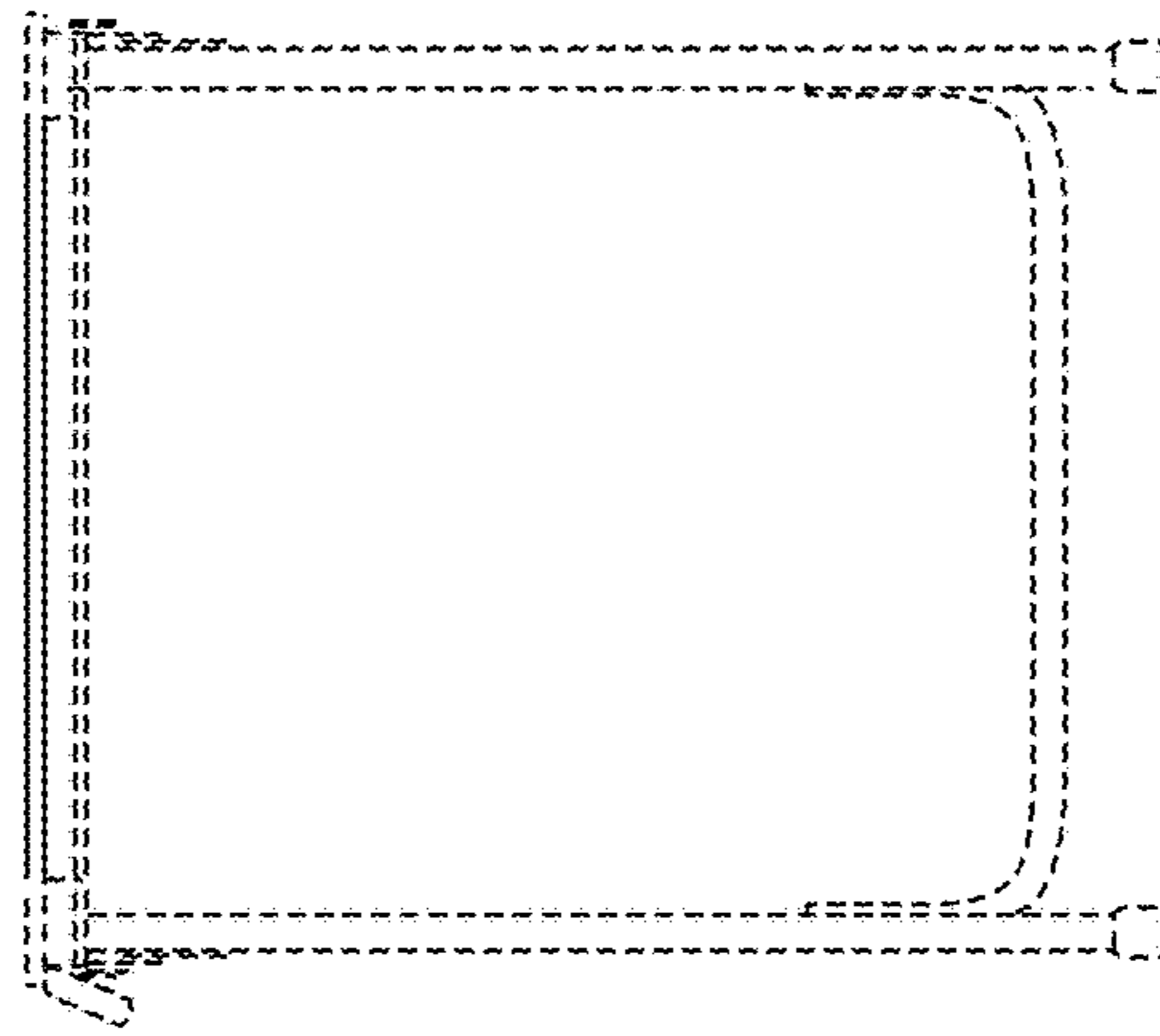

FIG. 14

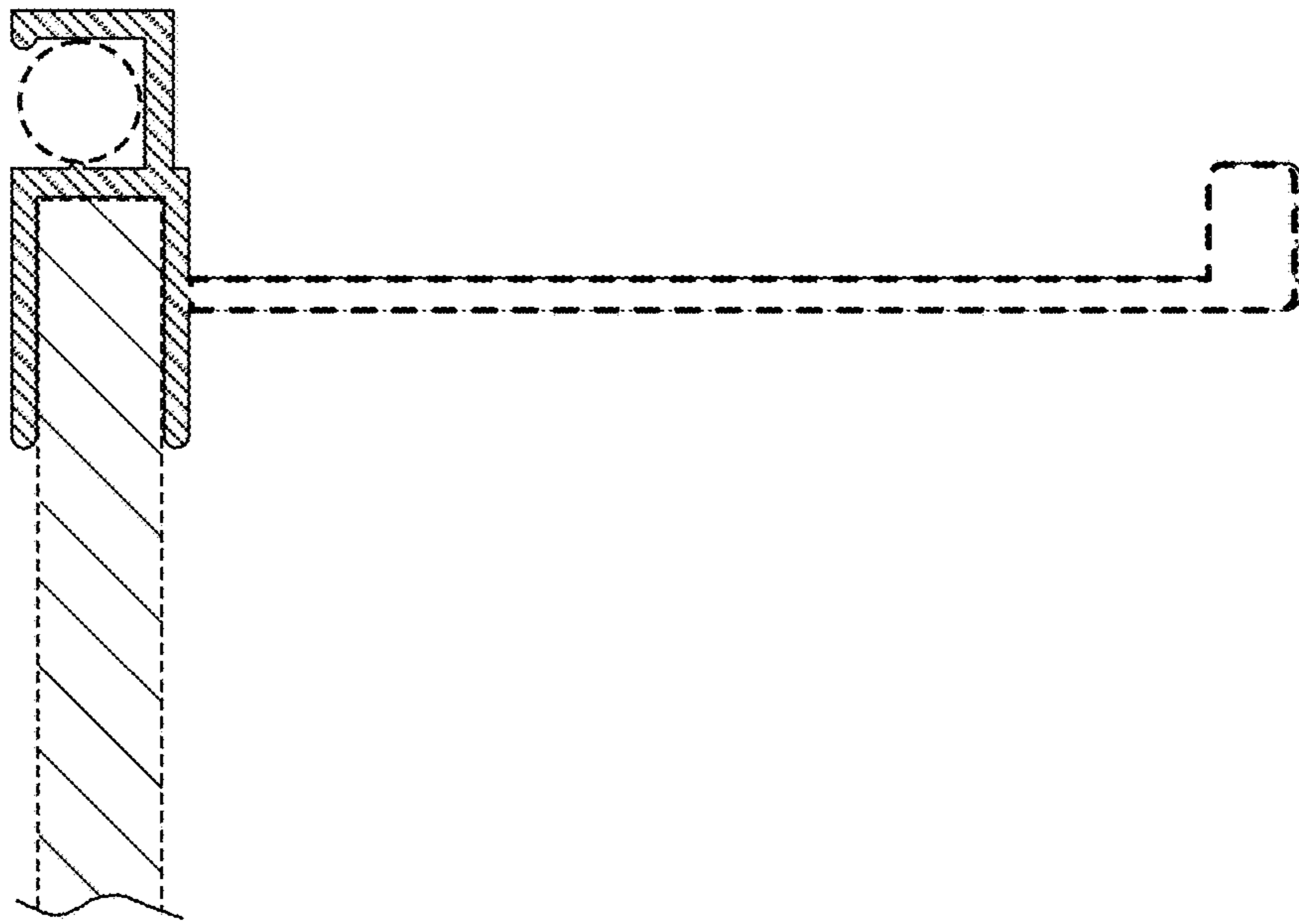

FIG. 16