



US00D854502S

(12) **United States Design Patent**  
**Meyer**

(10) **Patent No.:** **US D854,502 S**

(45) **Date of Patent:** **\*\* Jul. 23, 2019**

(54) **CABLE CONNECTOR**

(71) Applicant: **WAGO Verwaltungsgesellschaft mbH**,  
Minden (DE)

(72) Inventor: **Michael Meyer**, Wiedensahl (DE)

(73) Assignee: **WAGO Verwaltungsgesellschaft mbH**,  
Minden (DE)

(\*\*) Term: **15 Years**

(21) Appl. No.: **29/603,682**

(22) Filed: **May 11, 2017**

(51) **LOC (11) Cl.** ..... **13-03**

(52) **U.S. Cl.**  
USPC ..... **D13/147**

(58) **Field of Classification Search**  
USPC ..... D13/133, 146, 147, 154, 184, 199  
CPC ..... H01R 9/09; H01R 9/091; H01R 9/098;  
H01R 9/22; H01R 9/24; H01R 9/2408;  
H01R 9/2691; H01R 9/28; H01R 4/029;  
H01R 4/28; H01R 4/4836; H01R 4/4818;  
H01R 4/4845; H01R 9/2475; H01R  
12/53; H01R 12/58; H01R 13/502  
See application file for complete search history.

(56) **References Cited**

**U.S. PATENT DOCUMENTS**

D693,303 S \* 11/2013 Bies ..... D13/133  
9,209,530 B2 \* 12/2015 Gassauer ..... H01R 4/48  
D756,302 S \* 5/2016 Chen ..... D13/133  
D756,305 S \* 5/2016 Kollmann ..... D13/133

9,543,700 B2 \* 1/2017 Kollmann ..... H01R 4/4836  
9,825,402 B2 \* 11/2017 Kollmann ..... H01R 13/62905  
D810,693 S \* 2/2018 Rao ..... D13/147

\* cited by examiner

*Primary Examiner* — Daniel D Bui

(74) *Attorney, Agent, or Firm* — Muncy, Geissler, Olds &  
Lowe, P.C.

(57) **CLAIM**

The ornamental design for a cable connector, as shown and described.

**DESCRIPTION**

FIG. 1 is a front perspective view of a first embodiment of a cable connector showing our new invention; FIG. 2 is a front elevation view thereof; FIG. 3 is a rear elevation view thereof; FIG. 4 is a left side elevation view thereof; FIG. 5 is a right side elevation view thereof; FIG. 6 is a top plan view thereof; and FIG. 7 is a bottom plan view thereof. FIG. 8 is a front perspective view of a second embodiment of a cable connector showing our new invention; FIG. 9 is a front elevation view thereof; FIG. 10 is a rear elevation view thereof; FIG. 11 is a left side elevation view thereof; FIG. 12 is a right side elevation view thereof; FIG. 13 is a top plan view thereof; and, FIG. 14 is a bottom plan view thereof. The dashed lines illustrate environment that does not form a part of the present invention, and no claim is made to the material illustrated with dashed lines.

**1 Claim, 14 Drawing Sheets**

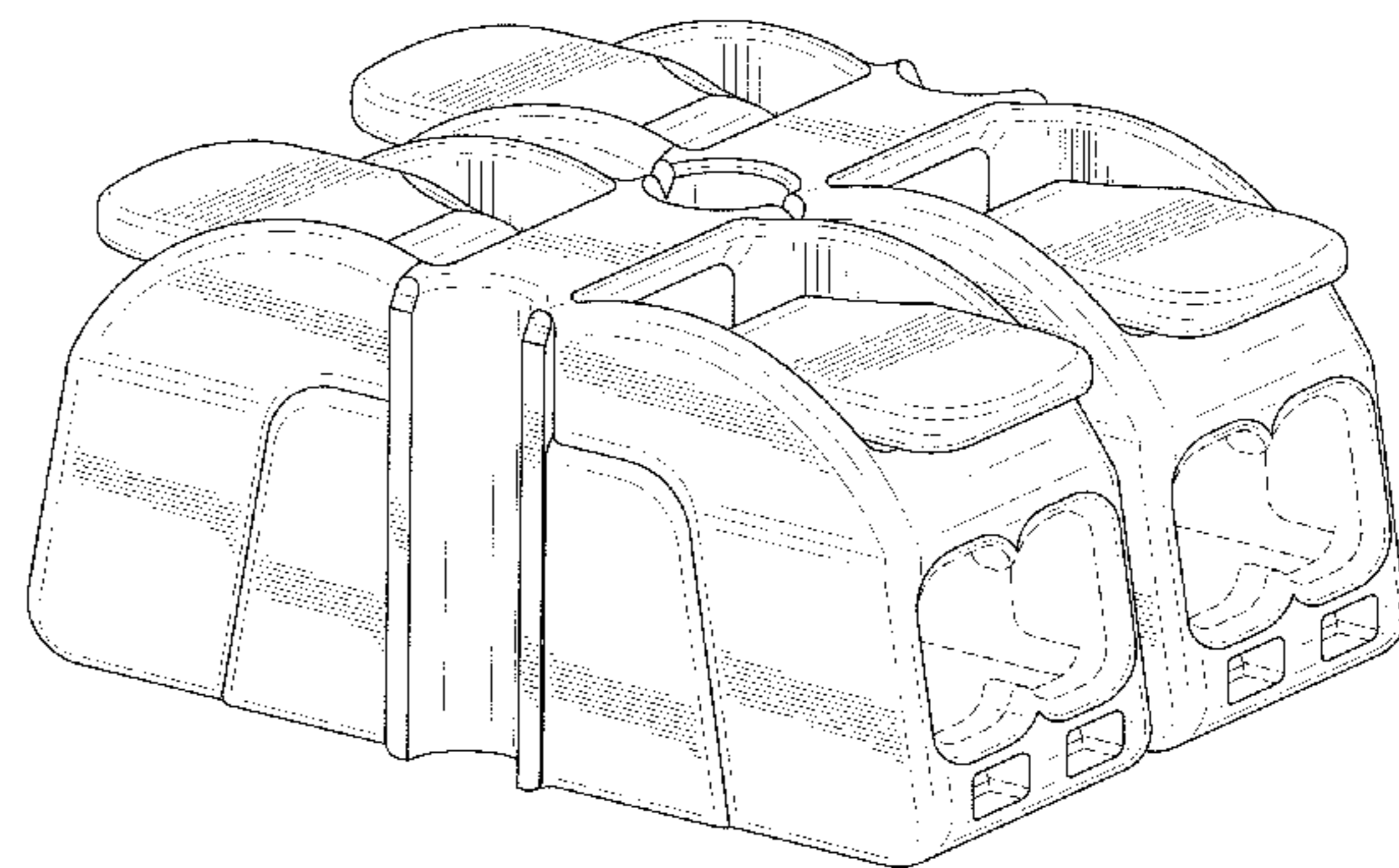
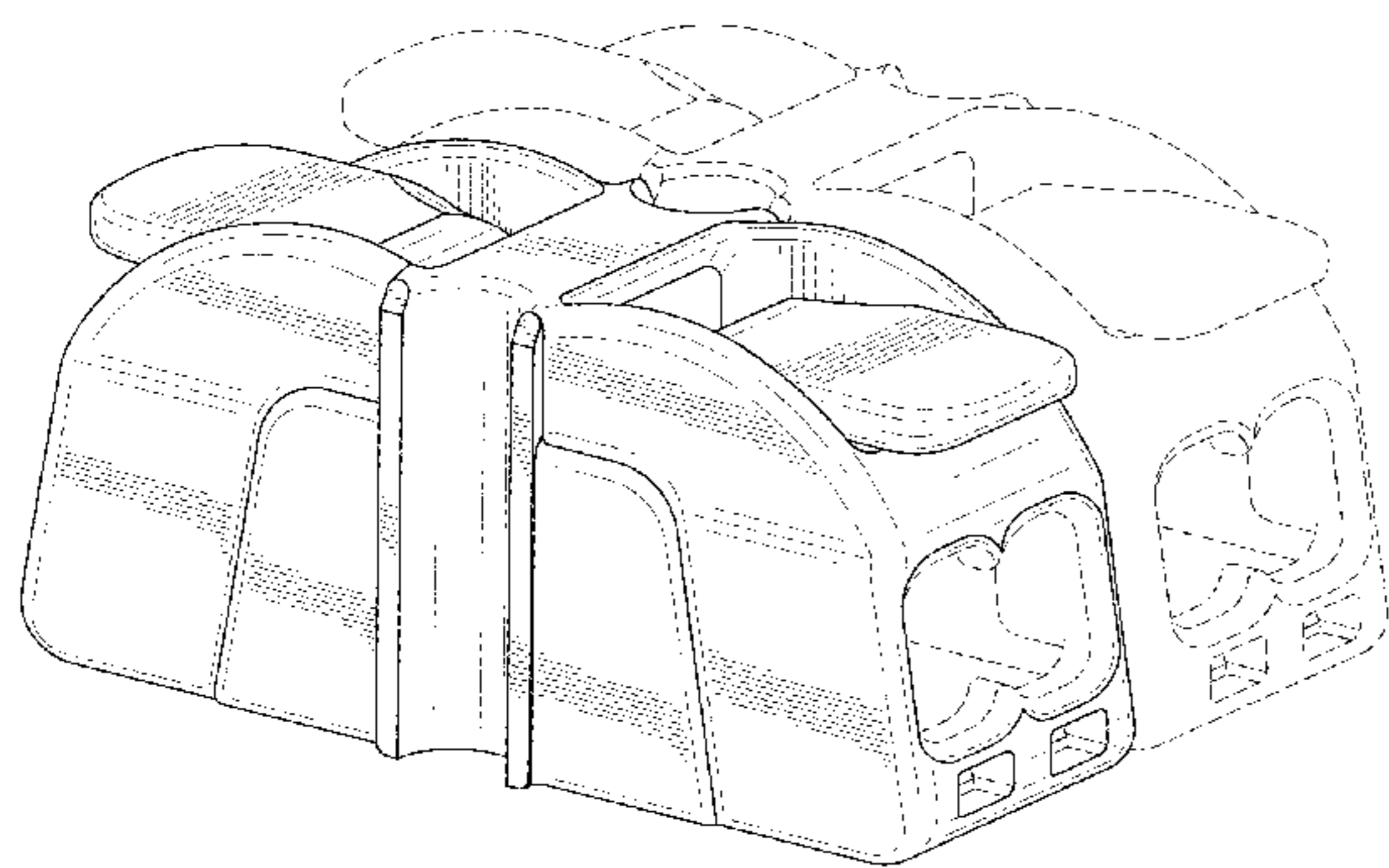

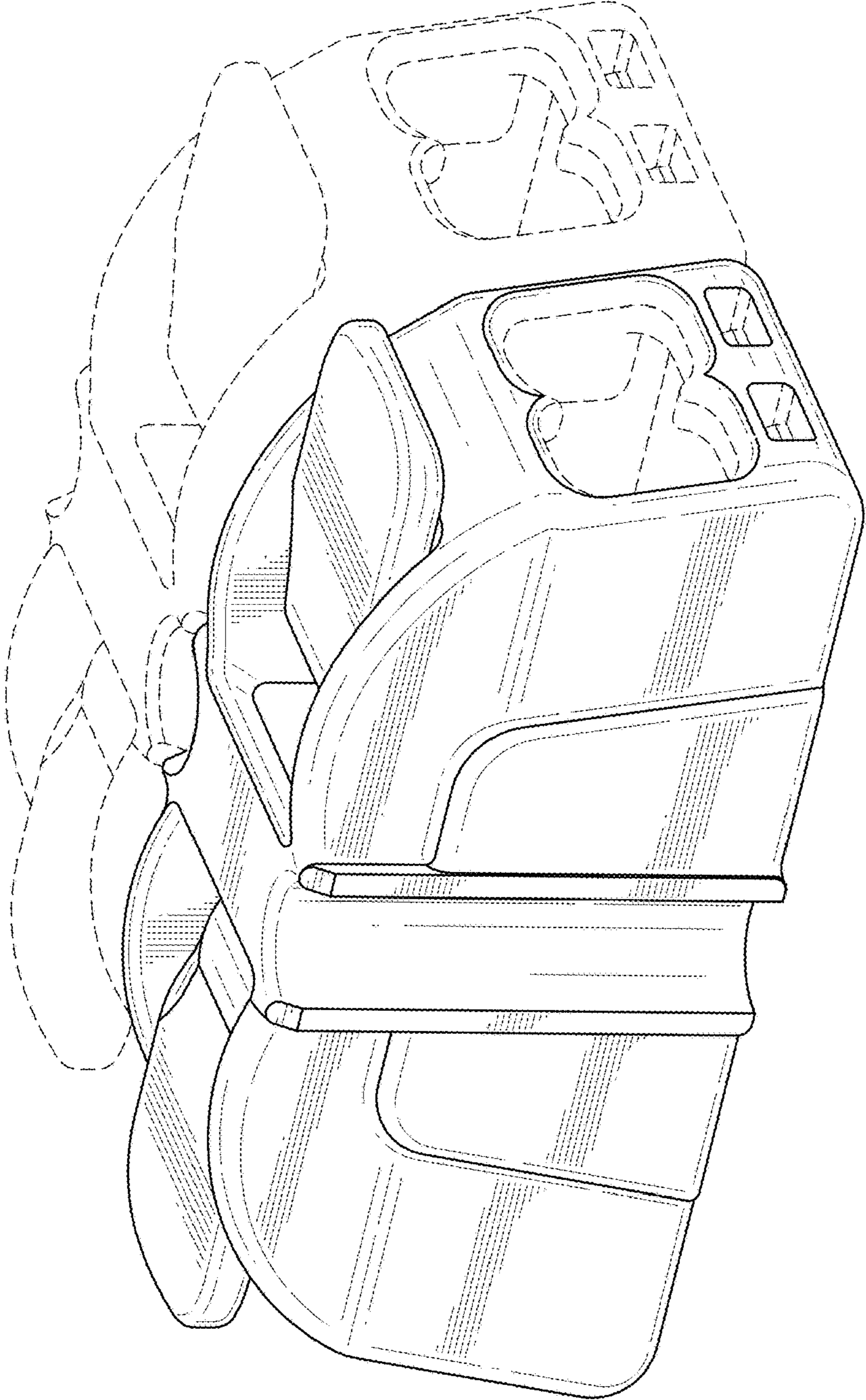

FIG.1

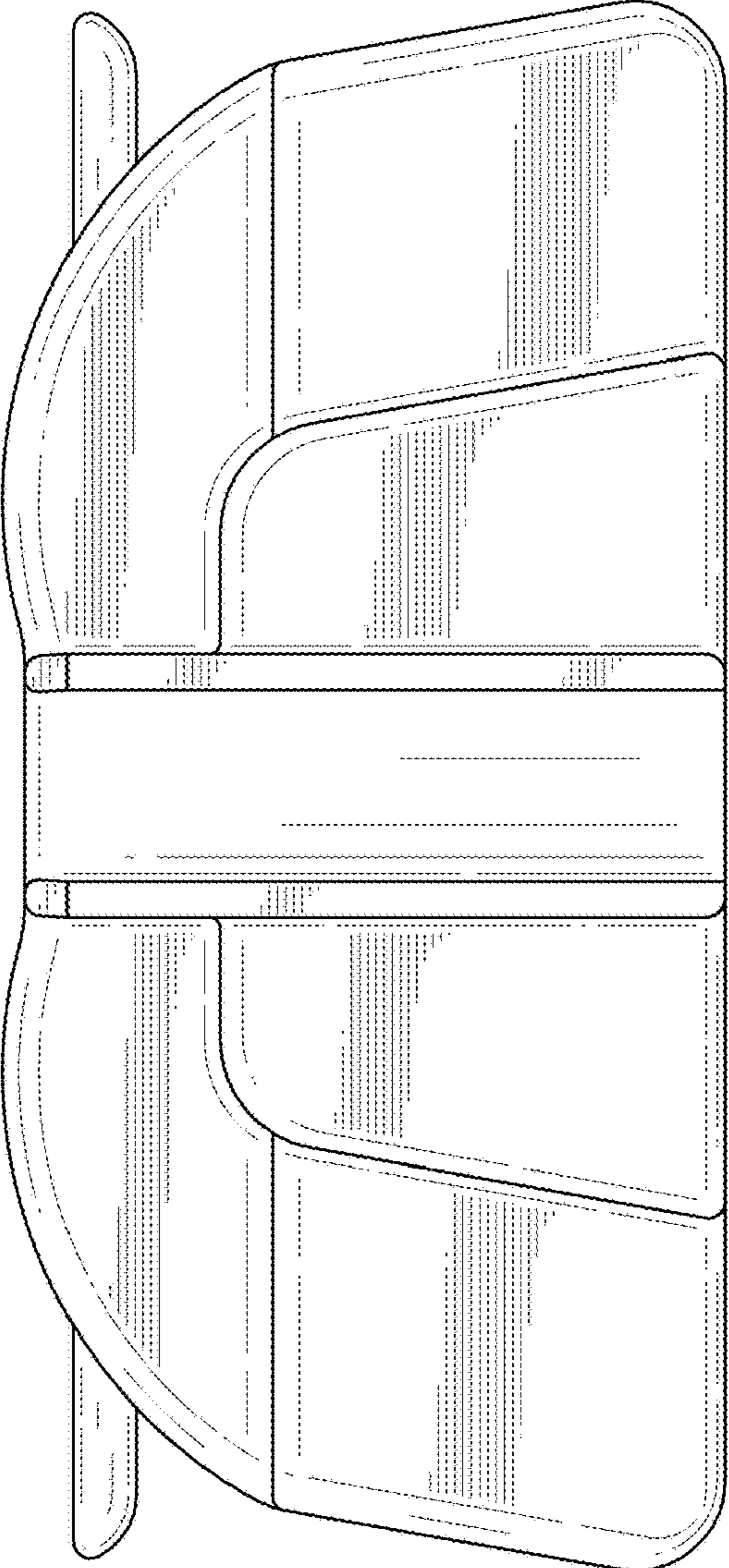

FIG.2

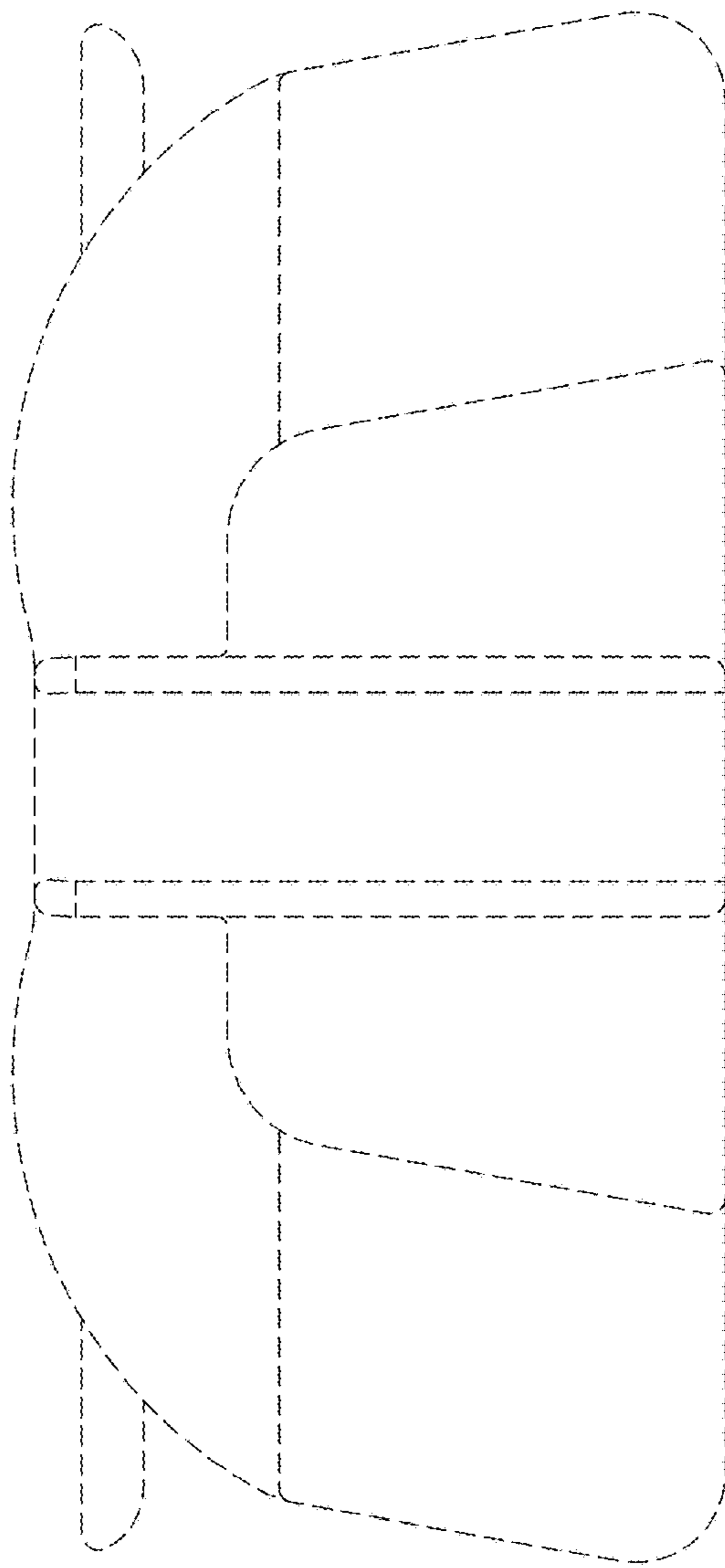

FIG.3

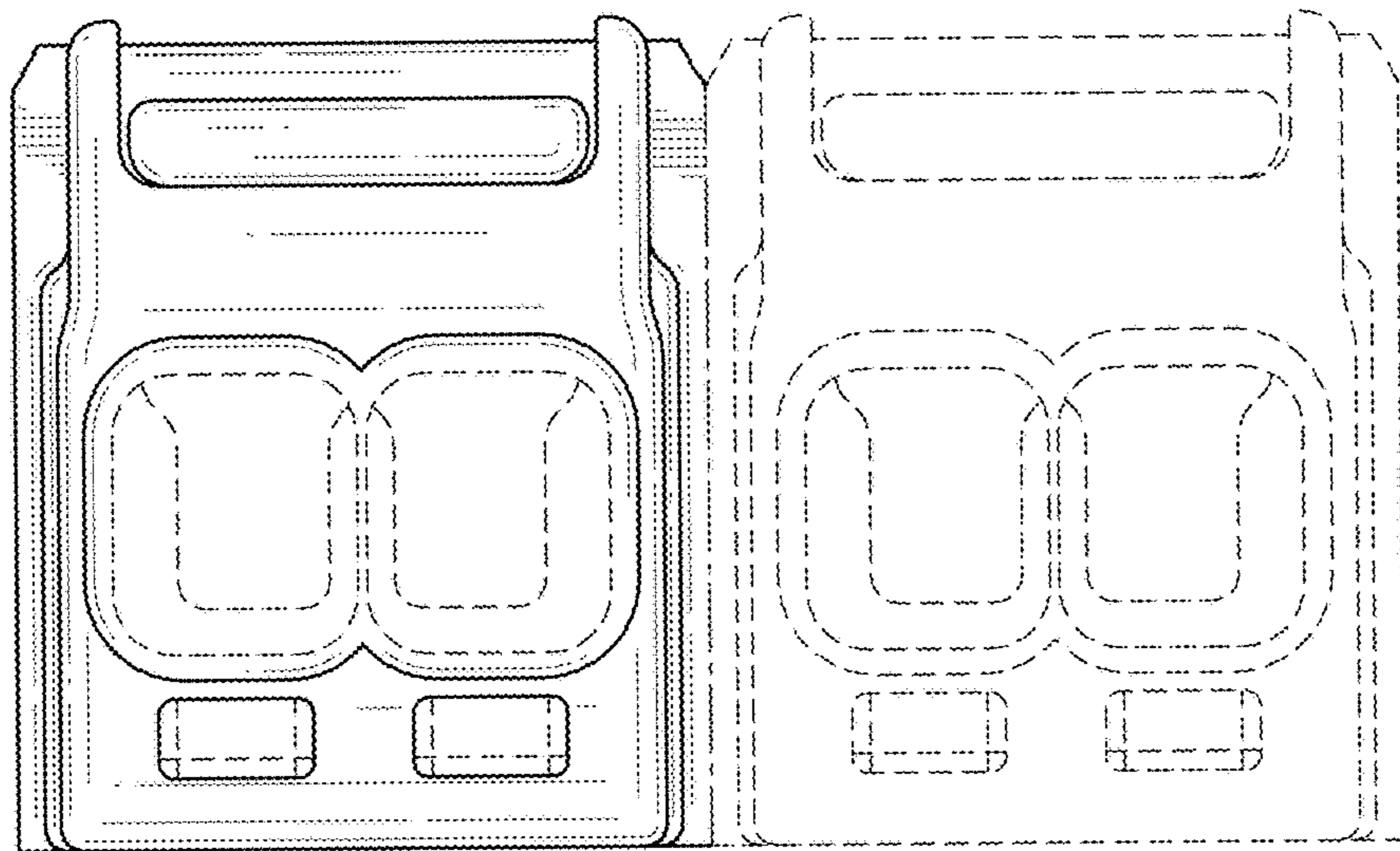

FIG.4

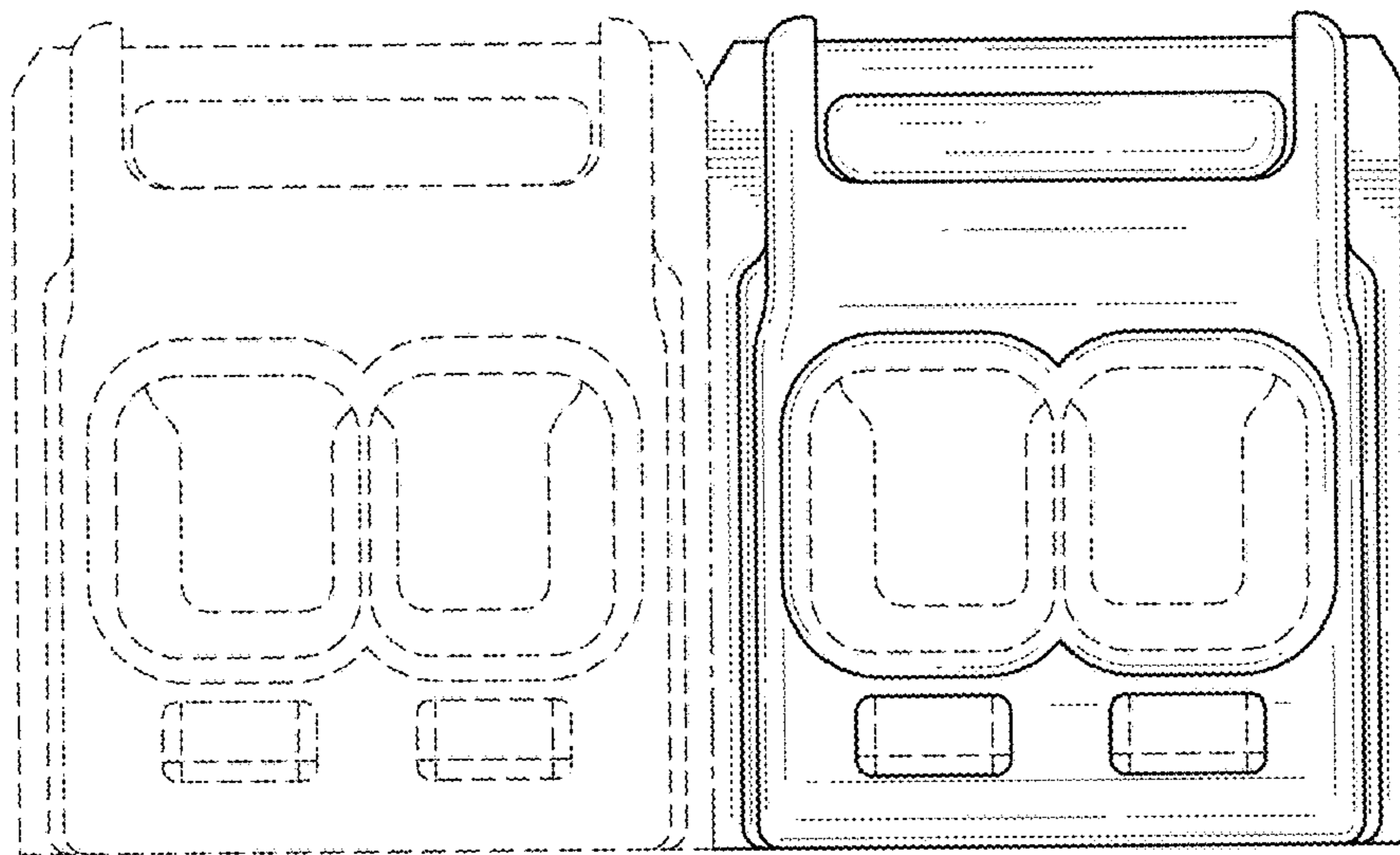

FIG.5

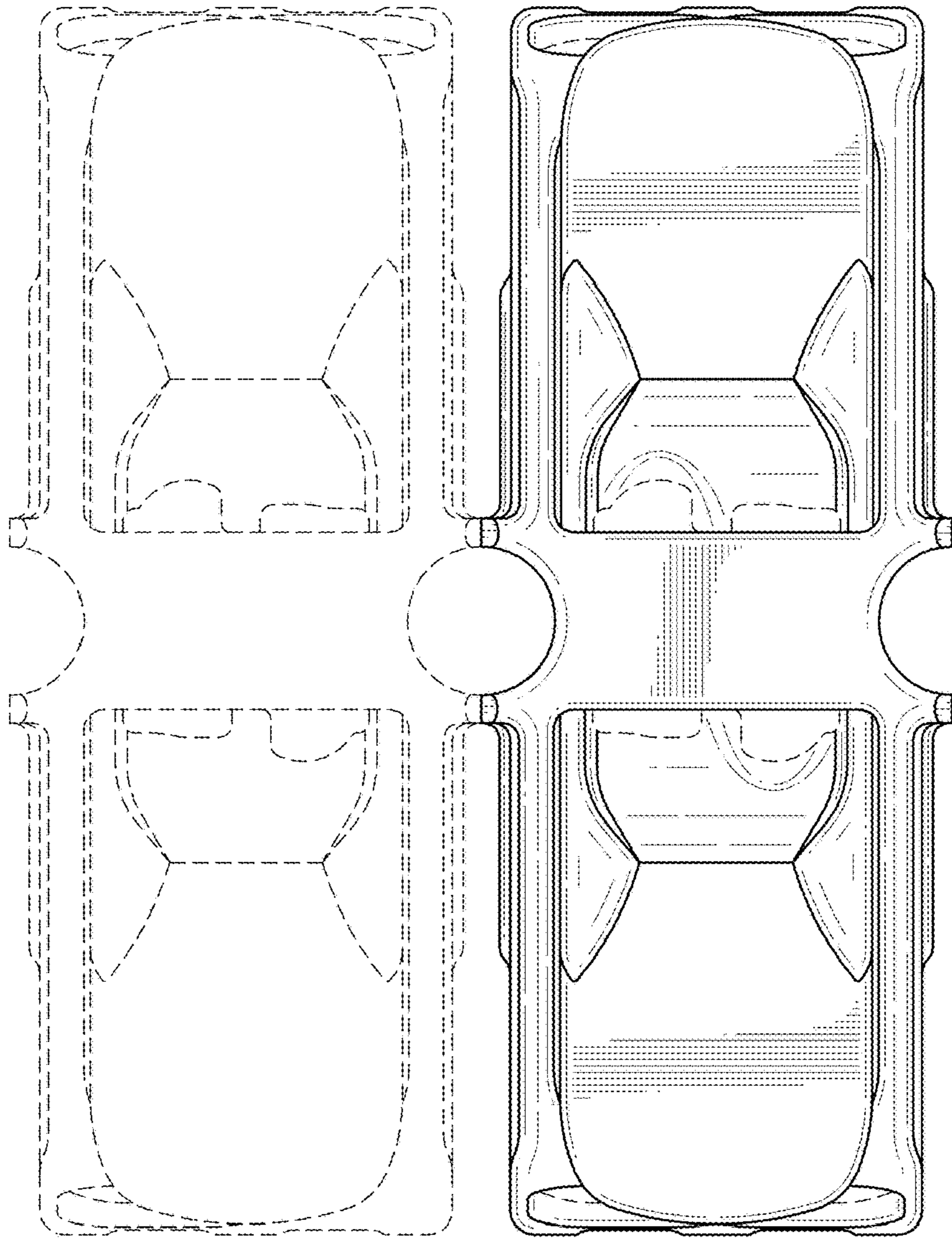

FIG.6

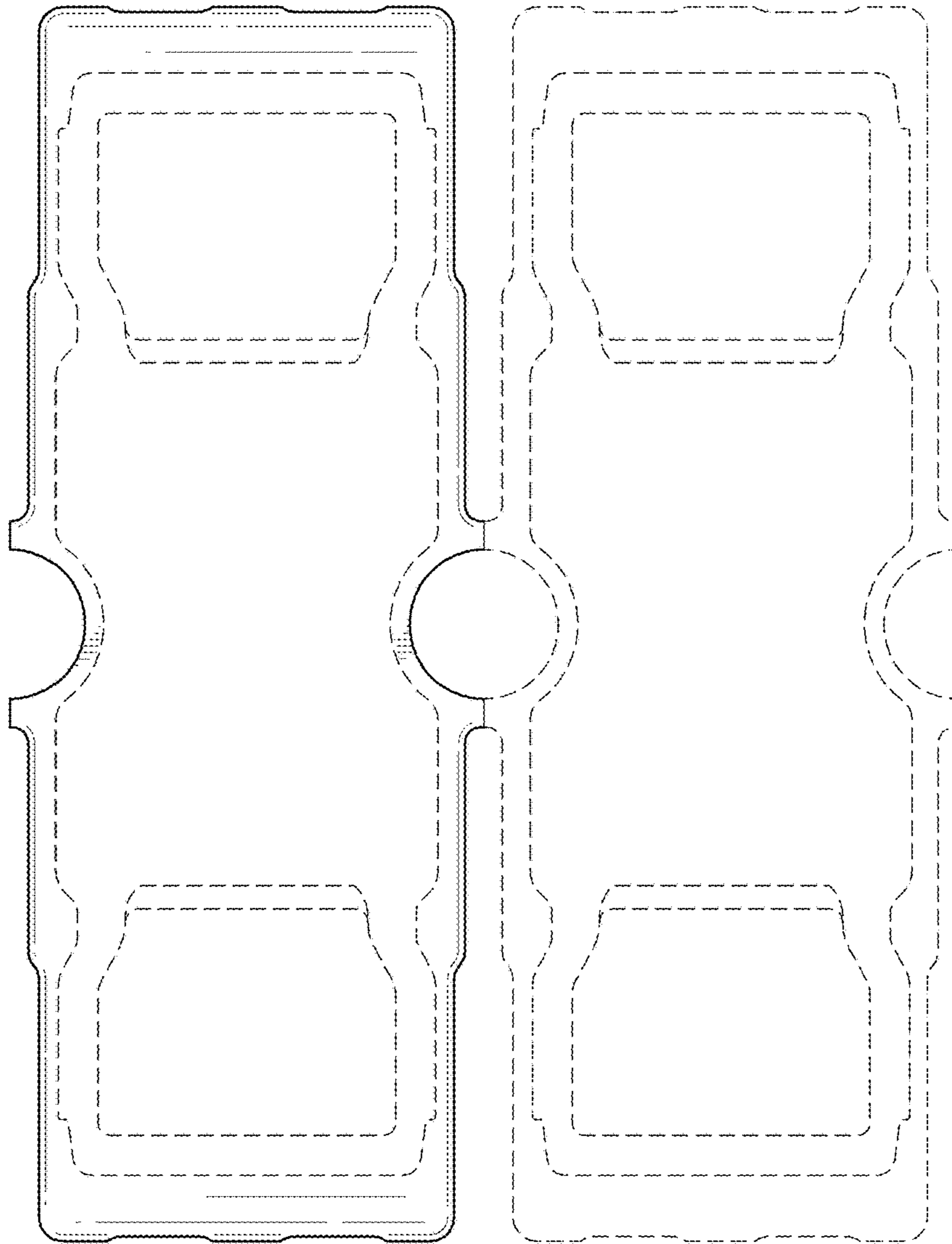

FIG.7



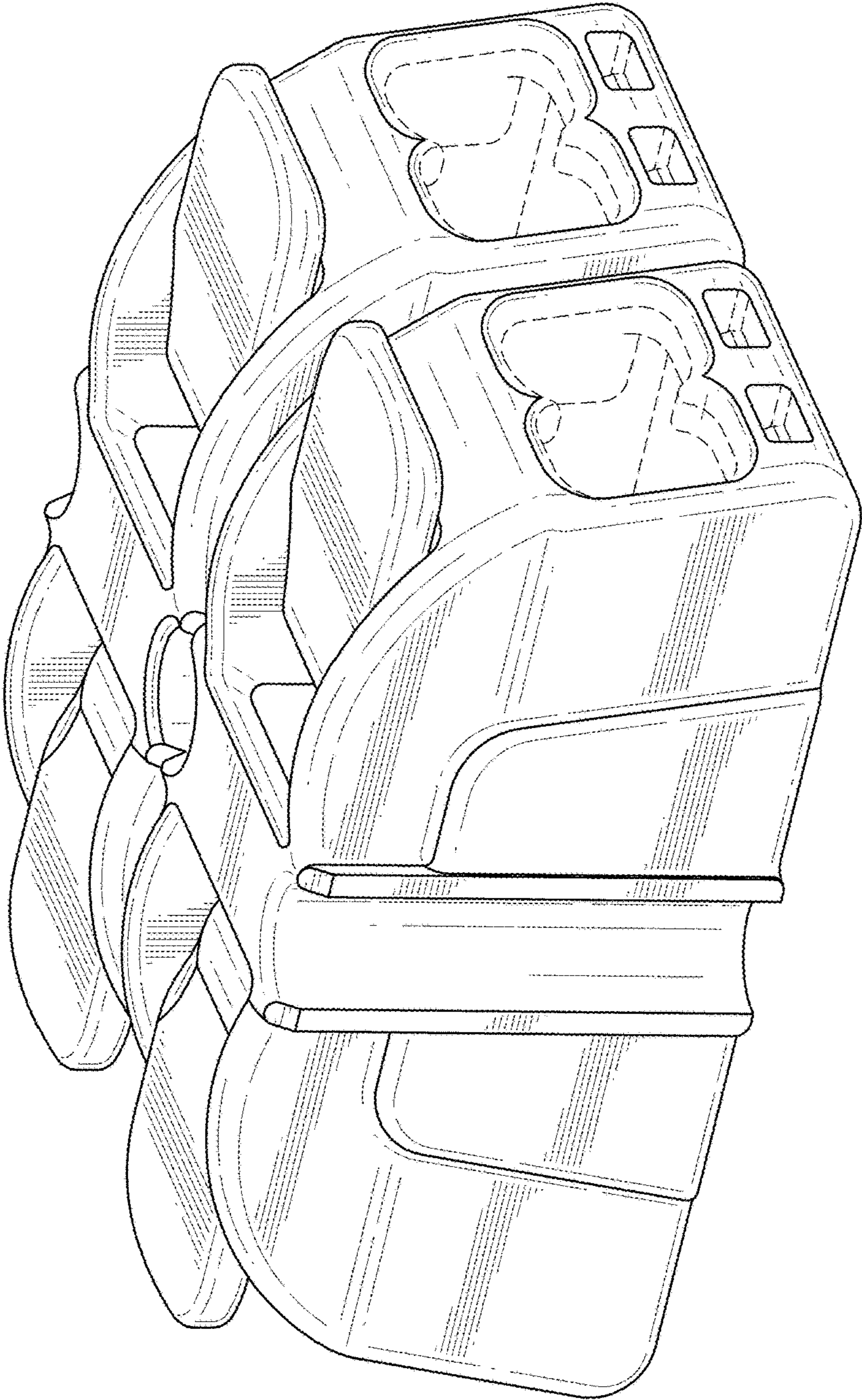

FIG.8

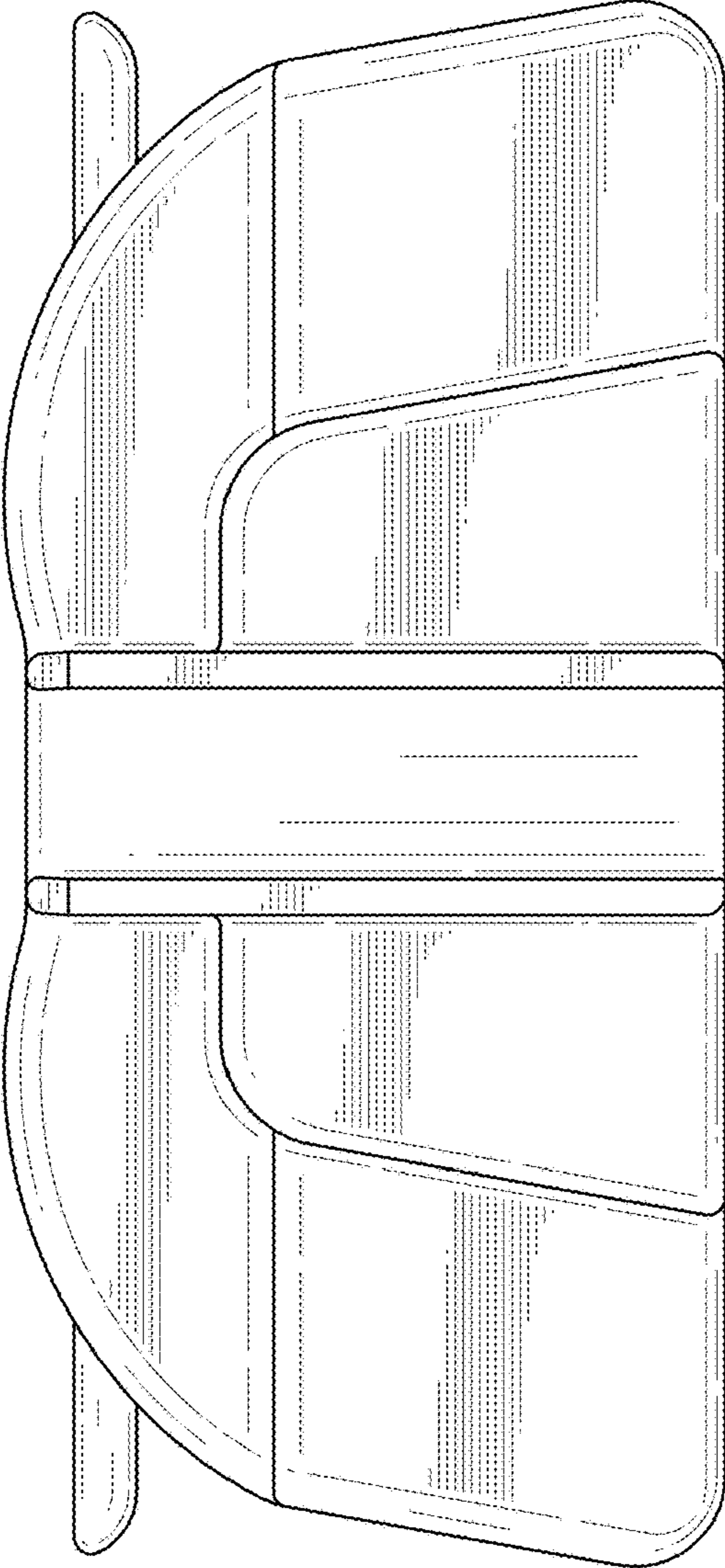

FIG. 9

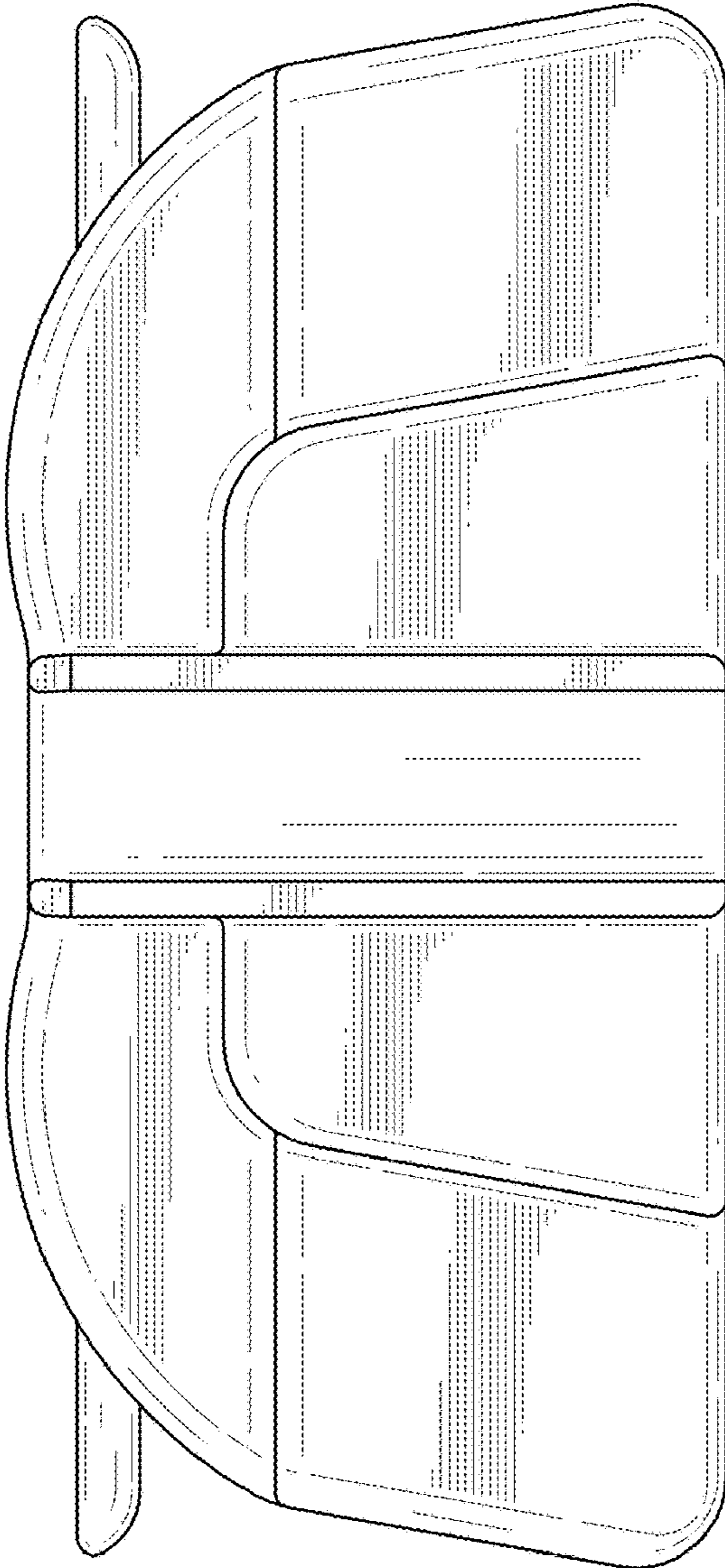

FIG.10

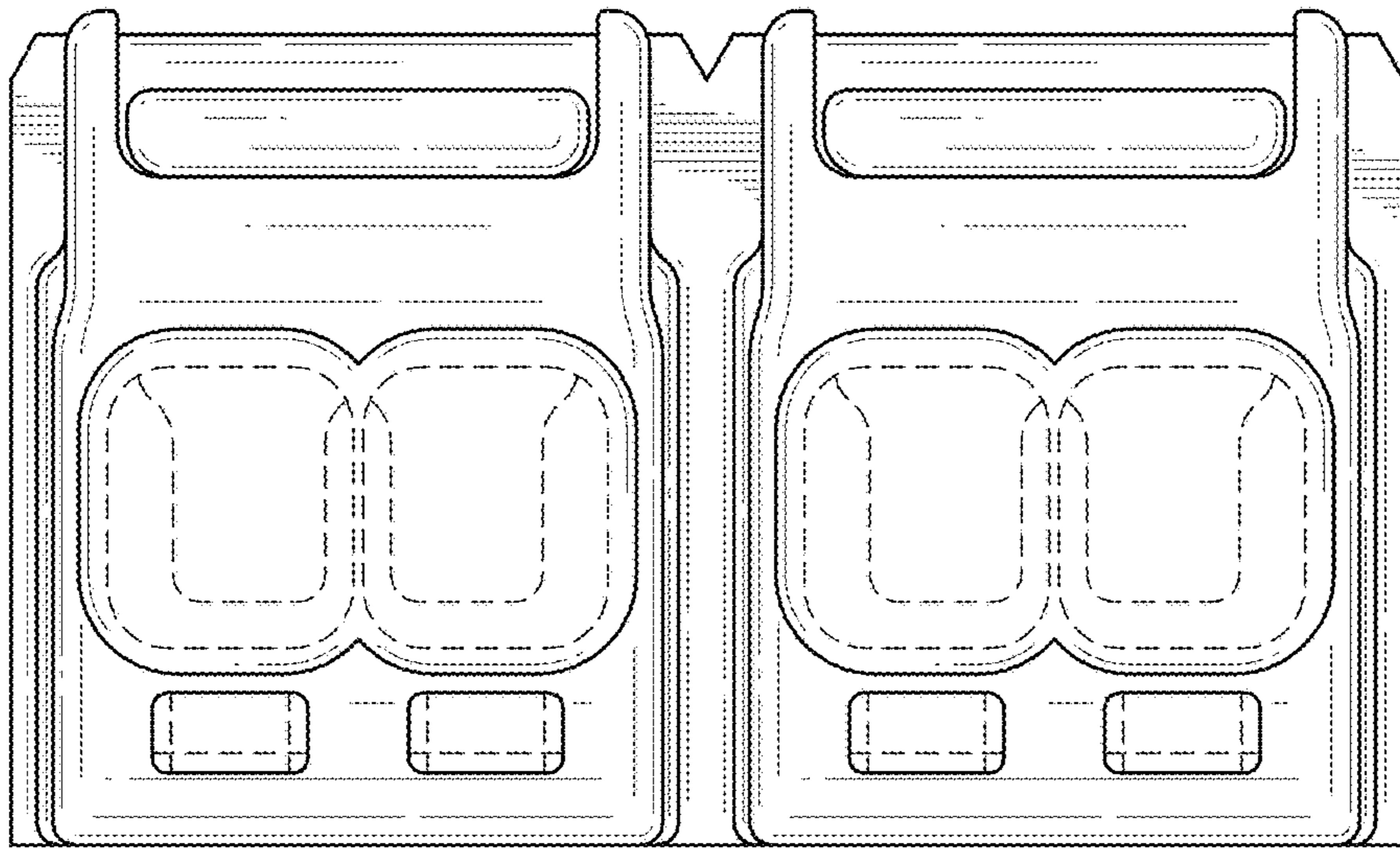

FIG.11

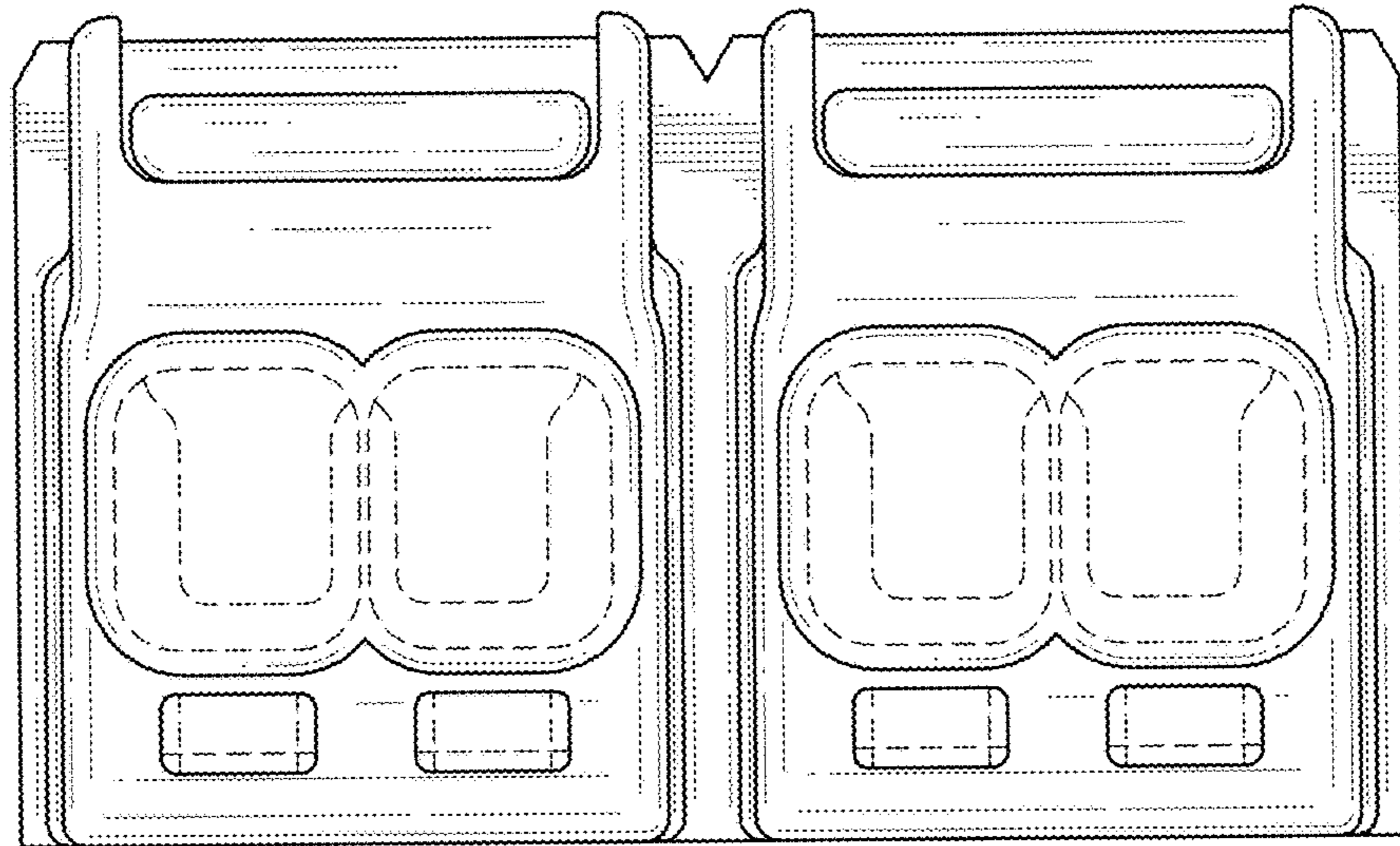

FIG.12

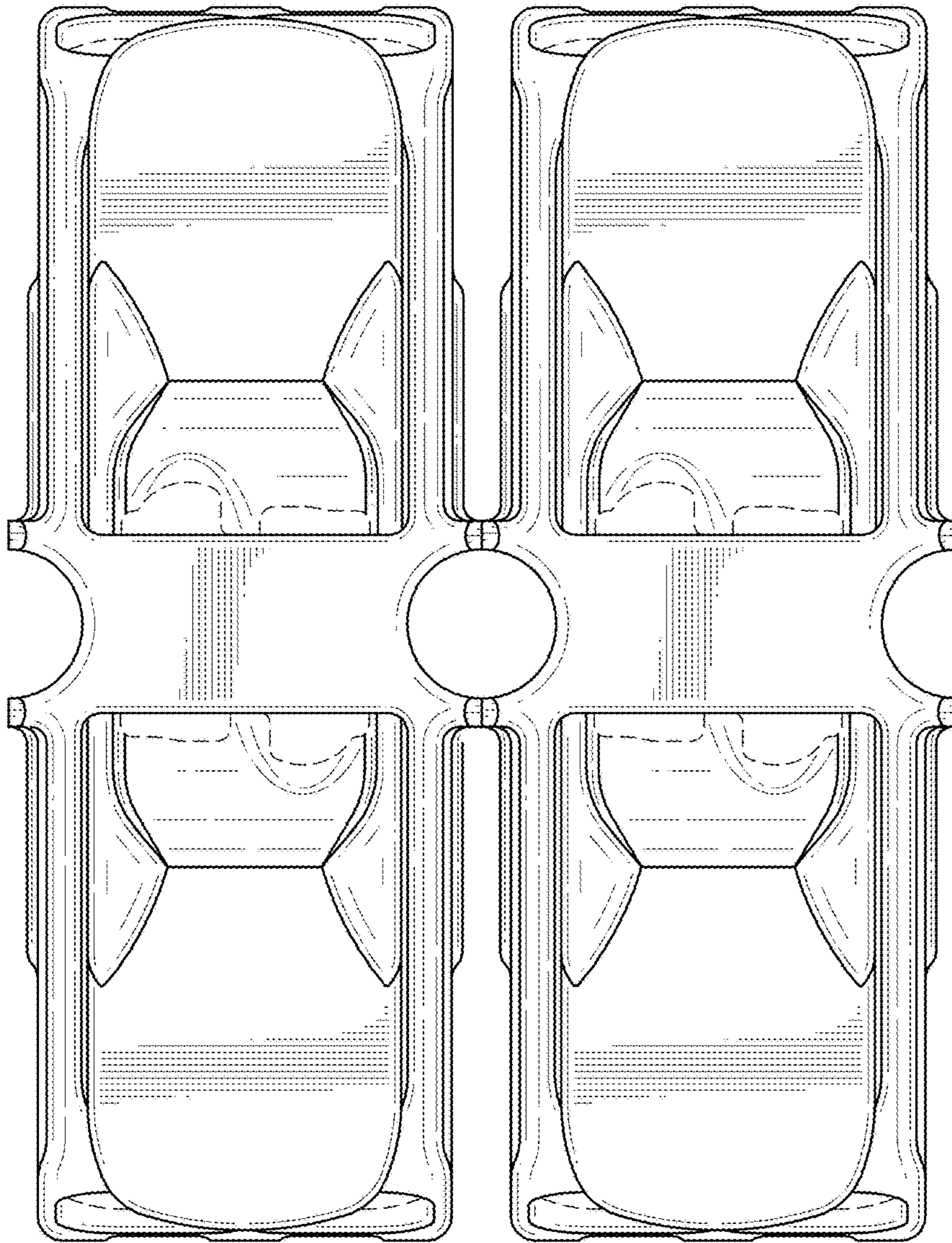

FIG.13

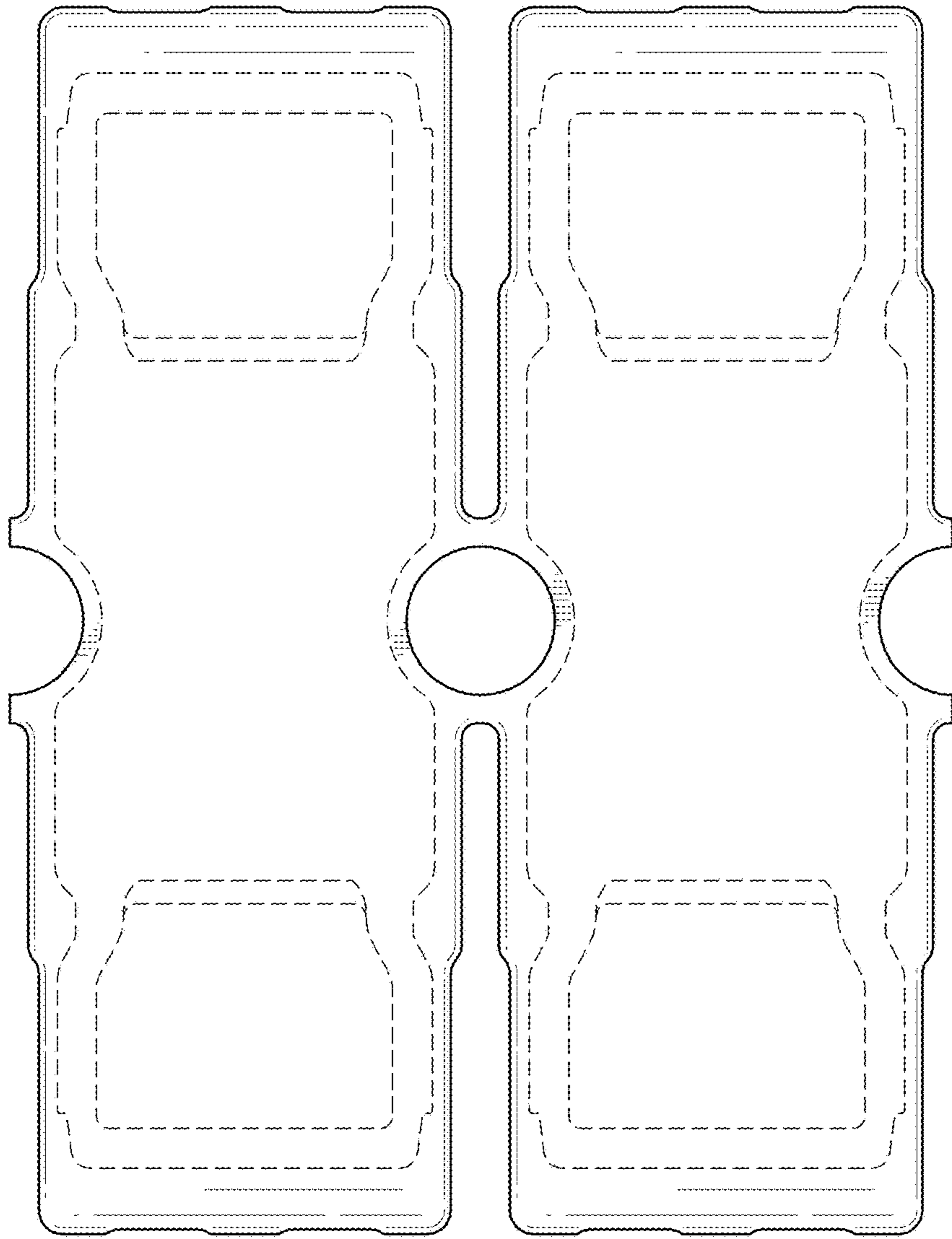

FIG.14